

# O-RING

121284



**Description:** O-RING  
**SKU:** 121284  
**OEM:** 3040817  
**Product Group:** ENGINE PARTS  
**Product Class:** OIL COOLERS & RELATED  
**UPC Code:** 193807089986  
**Sell Pack:** 10 EA  
 (Available to buy in increments of 10)  
**Weight:** 0.02 LBS  
**Warranty:** 2 Years



**Details:**

O-Ring, 0.097 in x 0.755 in  
 2.46 mm x 19.18 mm, Viton (90) Purple, Series # 3-910

**E-Catalog Pages:**

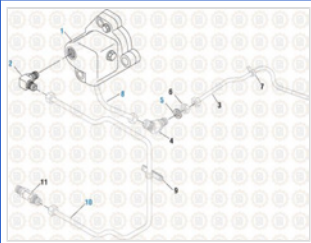
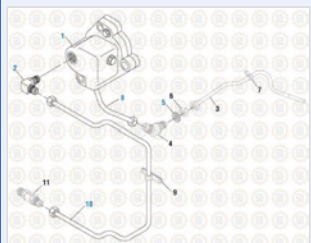
Catalog Page	Description
	<b>Drive Train 2016</b> T2060 & T2070 - Oil Pump Components - T2060 & T2070
	<b>Drive Train 2016</b> Oil Pump Components - T2080, T2090 and T2100

Copyright © 2020 PAI Industries, Inc.  
 All rights reserved. All content is property of PAI Industries, Inc, and may not be reproduced or redistributed in any form.

Any reference to OEM names or OEM product identification numbers/descriptions/model numbers is for identification only and does not indicate that it is an OEM part. PAI is not affiliated with Mack Truck, Inc.®, Volvo®, Fuller®, Cummins®, Eaton®, Rockwell®, Caterpillar®, Freightliner®, Hendrickson®, Kenworth®, Detroit Diesel®, International®, Peterbilt®, or Dana®. All Manufacturer's names, numbers, symbols and descriptions are used for reference only. It is not implied that any part listed is the product of these manufacturers.

## O-RING

121284

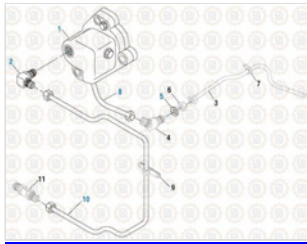

**Drive Train 2016**  
T2130 and T2180 - Oil Pump Components - T2130 and T2180

**Figure  
Having  
No  
Illustration**

**O-Rings**  
Parker Series 3

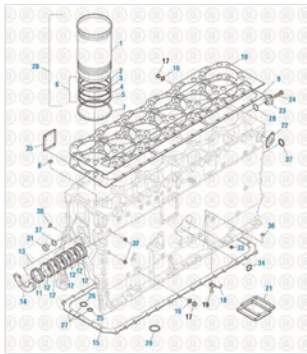

**Caterpillar Engine 2019**  
Cylinder Block - 3400 Series

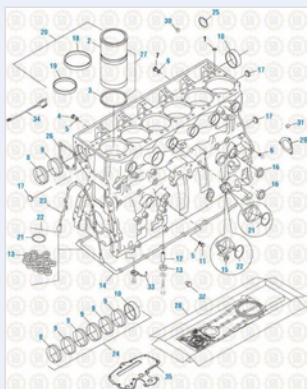

**Caterpillar Engine 2019**  
Cylinder Block - 3176 / C9 / C10 / C11 / C12 / C13 Series

Copyright © 2020 PAI Industries, Inc.

All rights reserved. All content is property of PAI Industries, Inc. and may not be reproduced or redistributed in any form.

Any reference to OEM names or OEM product identification numbers/descriptions/model numbers is for identification only and does not indicate that it is an OEM part. PAI is not affiliated with Mack Truck, Inc.®, Volvo®, Fuller®, Cummins®, Eaton®, Rockwell®, Caterpillar®, Freightliner®, Hendrickson®, Kenworth®, Detroit Diesel®, International®, Peterbilt®, or Dana®. All Manufacturer's names, numbers, symbols and descriptions are used for reference only. It is not implied that any part listed is the product of these manufacturers.

## O-RING

121284

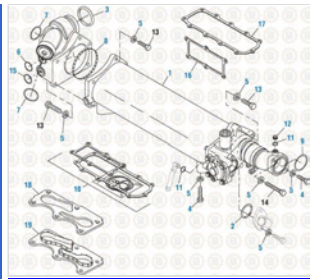

**Caterpillar Engine 2019**  
C11 and C13 - 3176 / C9 / C10 / C11 / C12 / C13 Series

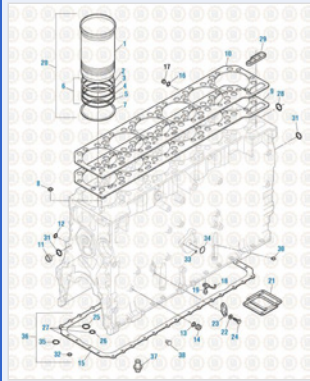

**Caterpillar Engine 2019**  
Cylinder Block - 3406E / C15 / C16 / C18 Series



**Cummins Engine 2017**  
Fuel Miscellaneous - 855 Series

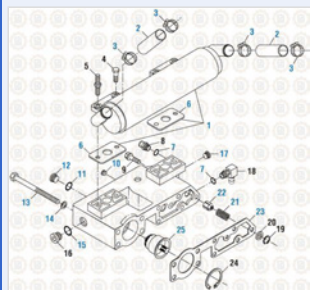

**Cummins Engine 2017**  
L10 Series - L10 / M11 / ISM Series

Copyright © 2020 PAI Industries, Inc.  
All rights reserved. All content is property of PAI Industries, Inc. and may not be reproduced or redistributed in any form.

Any reference to OEM names or OEM product identification numbers/descriptions/model numbers is for identification only and does not indicate that it is an OEM part. PAI is not affiliated with Mack Truck, Inc.®, Volvo®, Fuller®, Cummins®, Eaton®, Rockwell®, Caterpillar®, Freightliner®, Hendrickson®, Kenworth®, Detroit Diesel®, International®, Peterbilt®, or Dana®. All Manufacturer's names, numbers, symbols and descriptions are used for reference only. It is not implied that any part listed is the product of these manufacturers.

# O-RING

121284

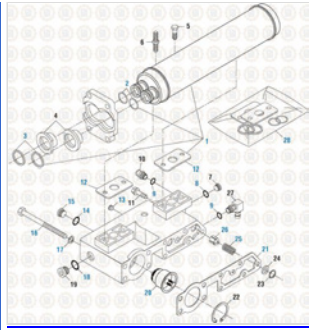



**Cummins Engine 2017**  
M11 Series - L10 / M11 / ISM Series



**Cummins Engine 2017**  
Fuel Miscellaneous - N14 Series

**Component Of:**







SKU	Image	Description
<a href="#">321302</a>	.	O-RING KIT
<a href="#">321411</a>		OIL COOLER GASKET KIT
<a href="#">331125-150</a>	.	VALVE COVER GASKET KIT
<a href="#">331139-151</a>	.	VALVE COVER GASKET KIT
<a href="#">331165-150</a>	.	CYLINDER HEAD GASKET KIT
<a href="#">331230</a>	.	UPPER GASKET KIT
<a href="#">331231</a>	.	UPPER GASKET KIT
<a href="#">331232</a>	.	UPPER GASKET KIT
<a href="#">331234-200</a>		O-RING SUB KIT
<a href="#">331237</a>	.	UPPER GASKET KIT

Copyright © 2020 PAI Industries, Inc.  
All rights reserved. All content is property of PAI Industries, Inc. and may not be reproduced or redistributed in any form.

Any reference to OEM names or OEM product identification numbers/descriptions/model numbers is for identification only and does not indicate that it is an OEM part. PAI is not affiliated with Mack Truck, Inc.®, Volvo®, Fuller®, Cummins®, Eaton®, Rockwell®, Caterpillar®, Freightliner®, Hendrickson®, Kenworth®, Detroit Diesel®, International®, Peterbilt®, or Dana®. All Manufacturer's names, numbers, symbols and descriptions are used for reference only. It is not implied that any part listed is the product of these manufacturers.

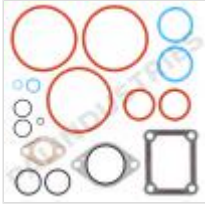
# O-RING

121284









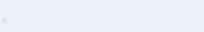

<a href="#">331239</a>		UPPER GASKET KIT
<a href="#">331240</a>		UPPER GASKET KIT
<a href="#">331334</a>		GASKET KIT
<a href="#">331390</a>		OIL COOLER GASKET KIT
<a href="#">331391</a>		OIL COOLER GASKET KIT
<a href="#">331393</a>		TURBOCHARGER MOUNTING GASKET
<a href="#">331410-154</a>		FUEL O-RING KIT
<a href="#">331411-154</a>		FUEL O-RING KIT
<a href="#">331414</a>		FUEL GASKET KIT

Copyright © 2020 PAI Industries, Inc.  
 All rights reserved. All content is property of PAI Industries, Inc. and may not be reproduced or redistributed in any form.

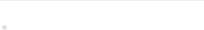
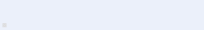
Any reference to OEM names or OEM product identification numbers/descriptions/model numbers is for identification only and does not indicate that it is an OEM part. PAI is not affiliated with Mack Truck, Inc.®, Volvo®, Fuller®, Cummins®, Eaton®, Rockwell®, Caterpillar®, Freightliner®, Hendrickson®, Kenworth®, Detroit Diesel®, International®, Peterbilt®, or Dana®. All Manufacturer's names, numbers, symbols and descriptions are used for reference only. It is not implied that any part listed is the product of these manufacturers.

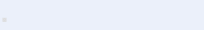
# O-RING

121284

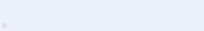
<a href="#">331416</a>		FRONT GASKET KIT
<a href="#">331424</a>		CENTRAL-LOWER GASKET KIT
<a href="#">331430</a>		TURBOCHARGER MOUNTING GASKET KIT
<a href="#">331431</a>		OIL COOLER GASKET KIT
<a href="#">331470-150</a>		FUEL GASKET KIT
<a href="#">331496</a>		COMPRESSOR GASKET SET
<a href="#">331497</a>		COMPRESSOR GASKET SET
<a href="#">331500</a>		FUEL GASKET KIT
<a href="#">331511</a>		FRONT GASKET KIT
<a href="#">331512</a>		OIL COOLER GASKET KIT
<a href="#">331515</a>		FRONT COVER GASKET KIT
<a href="#">331543</a>		WATER PUMP GASKET SET
<a href="#">331545</a>		FUEL GASKET KIT

Copyright © 2020 PAI Industries, Inc.

All rights reserved. All content is property of PAI Industries, Inc. and may not be reproduced or redistributed in any form.

Any reference to OEM names or OEM product identification numbers/descriptions/model numbers is for identification only and does not indicate that it is an OEM part. PAI is not affiliated with Mack Truck, Inc.®, Volvo®, Fuller®, Cummins®, Eaton®, Rockwell®, Caterpillar®, Freightliner®, Hendrickson®, Kenworth®, Detroit Diesel®, International®, Peterbilt®, or Dana®. All Manufacturer's names, numbers, symbols and descriptions are used for reference only. It is not implied that any part listed is the product of these manufacturers.

## O-RING

121284

<a href="#">331546</a>		OIL COOLER GASKET KIT
<a href="#">331560</a>		UPPER GASKET KIT
<a href="#">331561</a>		UPPER GASKET KIT
<a href="#">331562</a>		LOWER GASKET SET
<a href="#">331567</a>		TURBOCHARGER INSTALLATION KIT
<a href="#">331573</a>		REAR GASKET KIT
<a href="#">331627</a>		CENTRAL/LOWER GASKET SET
<a href="#">331648</a>		UPPER GASKET KIT
<a href="#">331652</a>		OIL COOLER GASKET KIT
<a href="#">380171</a>		FUEL CHECKVALVE
<a href="#">131263</a>		LOWER GASKET SET
<a href="#">131482-100</a>		UPPER GASKET KIT
<a href="#">131482-150</a>		FUEL O-RING KIT
<a href="#">131722</a>		LOWER GASKET SET
<a href="#">131815</a>		UPPER GASKET KIT
<a href="#">131816</a>		UPPER GASKET KIT
<a href="#">131888</a>		UPPER GASKET KIT
<a href="#">131902</a>		LOWER GASKET KIT

Copyright © 2020 PAI Industries, Inc.

All rights reserved. All content is property of PAI Industries, Inc. and may not be reproduced or redistributed in any form.

Any reference to OEM names or OEM product identification numbers/descriptions/model numbers is for identification only and does not indicate that it is an OEM part. PAI is not affiliated with Mack Truck, Inc.®, Volvo®, Fuller®, Cummins®, Eaton®, Rockwell®, Caterpillar®, Freightliner®, Hendrickson®, Kenworth®, Detroit Diesel®, International®, Peterbilt®, or Dana®. All Manufacturer's names, numbers, symbols and descriptions are used for reference only. It is not implied that any part listed is the product of these manufacturers.

# O-RING

121284

[ECP-3476](#)



PIPE PLUG

[GBK-8955-200](#)



O-RING KIT

### Cross Reference:

Manufacturer	OEM Number
CATERPILLAR	238-5081
CATERPILLAR	2385081
CATERPILLAR	6V4589
CUMMINS	129858
CUMMINS	3040817
MACK	56AX410
MACK	25097766
CATERPILLAR	0336027
CATERPILLAR	033-6027
CATERPILLAR	336027
CATERPILLAR	33-6027
CATERPILLAR	1522939
CATERPILLAR	152-2939

Copyright © 2020 PAI Industries, Inc.  
 All rights reserved. All content is property of PAI Industries, Inc. and may not be reproduced or redistributed in any form.

Any reference to OEM names or OEM product identification numbers/descriptions/model numbers is for identification only and does not indicate that it is an OEM part. PAI is not affiliated with Mack Truck, Inc.®, Volvo®, Fuller®, Cummins®, Eaton®, Rockwell®, Caterpillar®, Freightliner®, Hendrickson®, Kenworth®, Detroit Diesel®, International®, Peterbilt®, or Dana®. All Manufacturer's names, numbers, symbols and descriptions are used for reference only. It is not implied that any part listed is the product of these manufacturers.