

# O-RING

121221



**Description:** O-RING  
**SKU:** 121221  
**OEM:** 3007713  
**Product Group:** ENGINE PARTS  
**Product Class:** OIL COOLERS & RELATED  
**UPC Code:** 193807089061  
**Sell Pack:** 5 EA  
 (Available to buy in increments of 5)  
**Weight:** 0.07 LBS  
**Warranty:** 2 Years



**Details:**

O-Ring  
 0.139 in C/S x 4.984 in ID  
 3.53 mm C/S x 126.59 mm ID  
 EPDM 70, Series # -250

**Substitute:**

SKU	Sell Pack	Weight	Warranty	Description
<a href="#">BGA-2999</a>	5	0.07 LBS	2 Years	O-RING

**E-Catalog Pages:**

Catalog Page	Description
	<b>O-Rings</b> AS568A

**Copyright © 2020 PAI Industries, Inc.**  
 All rights reserved. All content is property of PAI Industries, Inc, and may not be reproduced or redistributed in any form.  
 Any reference to OEM names or OEM product identification numbers/descriptions/model numbers is for identification only and does not indicate that it is an OEM part. PAI is not affiliated with Mack Truck, Inc.®, Volvo®, Fuller®, Cummins®, Eaton®, Rockwell®, Caterpillar®, Freightliner®, Hendrickson®, Kenworth®, Detroit Diesel®, International®, Peterbilt®, or Dana®. All Manufacturer's names, numbers, symbols and descriptions are used for reference only. It is not implied that any part listed is the product of these manufacturers.

# O-RING

# 121221

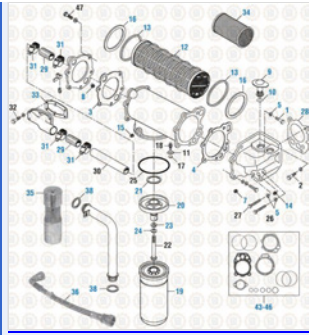

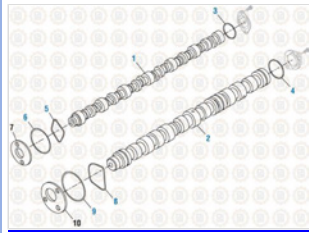

**Cummins Engine 2017**  
Small Cam and Big Cam - 855 Series



**Cummins Engine 2017**  
Camshaft - ISX Series

**Component Of:**



SKU	Image	Description
<a href="#">131331</a>	.	LOWER GASKET KIT
<a href="#">131336</a>	.	LOWER GASKET KIT
<a href="#">131337</a>		LOWER GASKET KIT
<a href="#">131397</a>		OIL COOLER INSTALLATION KIT
<a href="#">131398</a>		OIL COOLER INSTALLATION KIT

Copyright © 2020 PAI Industries, Inc.  
All rights reserved. All content is property of PAI Industries, Inc. and may not be reproduced or redistributed in any form.

Any reference to OEM names or OEM product identification numbers/descriptions/model numbers is for identification only and does not indicate that it is an OEM part. PAI is not affiliated with Mack Truck, Inc.®, Volvo®, Fuller®, Cummins®, Eaton®, Rockwell®, Caterpillar®, Freightliner®, Hendrickson®, Kenworth®, Detroit Diesel®, International®, Peterbilt®, or Dana®. All Manufacturer's names, numbers, symbols and descriptions are used for reference only. It is not implied that any part listed is the product of these manufacturers.

# O-RING

121221

<a href="#">131399</a>		OIL COOLER INSTALLATION KIT
<a href="#">131422</a>		LOWER GASKET KIT
<a href="#">131431</a>		OIL COOLER INSTALLATION KIT
<a href="#">131800</a>		OVERHAUL GASKET KIT

Cross Reference:	
Manufacturer	OEM Number
CUMMINS	3679934
CUMMINS	148295
CUMMINS	187777
CUMMINS	3007713

Copyright © 2020 PAI Industries, Inc.  
 All rights reserved. All content is property of PAI Industries, Inc, and may not be reproduced or redistributed in any form.

Any reference to OEM names or OEM product identification numbers/descriptions/model numbers is for identification only and does not indicate that it is an OEM part. PAI is not affiliated with Mack Truck, Inc.®, Volvo®, Fuller®, Cummins®, Eaton®, Rockwell®, Caterpillar®, Freightliner®, Hendrickson®, Kenworth®, Detroit Diesel®, International®, Peterbilt®, or Dana®. All Manufacturer's names, numbers, symbols and descriptions are used for reference only. It is not implied that any part listed is the product of these manufacturers.