

# O-RING

# 121210

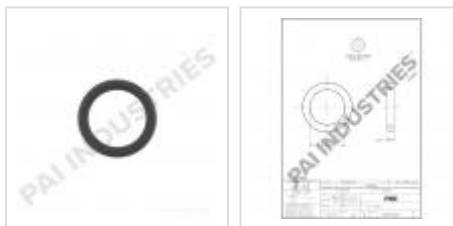

**Description:** O-RING  
**SKU:** 121210  
**OEM:** 3678912  
**Product Group:** ENGINE PARTS  
**Product Class:** ENGINE GASKETS, O-RINGS & GASKET SETS  
**UPC Code:** 193807088941  
**Sell Pack:** 5 EA  
 (Available to buy in increments of 5)  
**Weight:** 0.01 LBS  
**Warranty:** 2 Years



**Details:**

O-Ring  
 14 x 1.5M Fitting Thread, 0.445 in I.D. x 0.087 in Width  
 11.3 mm x 2.2 mm  
 Buna N (90), Peroxide Cured

**E-Catalog Pages:**

Catalog Page	Description
	<p><b>O-Rings</b>                      ISO 6149 Hydraulic Port</p>

**Copyright © 2020 PAI Industries, Inc.**  
 All rights reserved. All content is property of PAI Industries, Inc, and may not be reproduced or redistributed in any form.

Any reference to OEM names or OEM product identification numbers/descriptions/model numbers is for identification only and does not indicate that it is an OEM part. PAI is not affiliated with Mack Truck, Inc.®, Volvo®, Fuller®, Cummins®, Eaton®, Rockwell®, Caterpillar®, Freightliner®, Hendrickson®, Kenworth®, Detroit Diesel®, International®, Peterbilt®, or Dana®. All Manufacturer's names, numbers, symbols and descriptions are used for reference only. It is not implied that any part listed is the product of these manufacturers.

# O-RING

121210

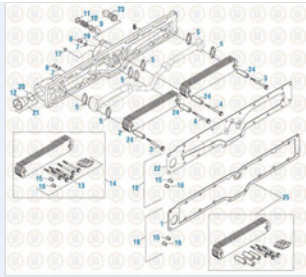

**Cummins Engine 2017**  
Oil Cooler - ISX Series

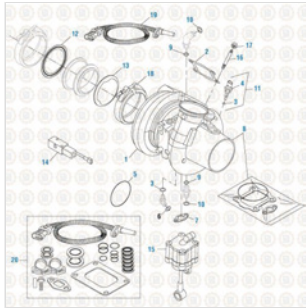

**Cummins Engine 2017**  
Turbocharger - ISX Series

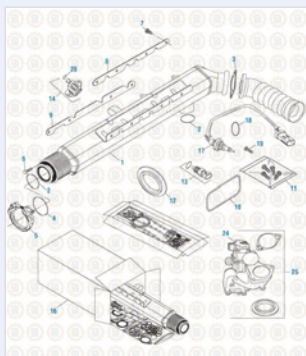

**Cummins Engine 2017**  
EGR Cooler - ISX Series

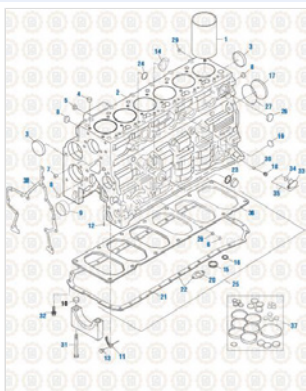

**Cummins Engine 2017**  
Cylinder Block Components - ISB / QSB Series

Component Of:		
SKU	Image	Description

Copyright © 2020 PAI Industries, Inc.  
All rights reserved. All content is property of PAI Industries, Inc. and may not be reproduced or redistributed in any form.

Any reference to OEM names or OEM product identification numbers/descriptions/model numbers is for identification only and does not indicate that it is an OEM part. PAI is not affiliated with Mack Truck, Inc.®, Volvo®, Fuller®, Cummins®, Eaton®, Rockwell®, Caterpillar®, Freightliner®, Hendrickson®, Kenworth®, Detroit Diesel®, International®, Peterbilt®, or Dana®. All Manufacturer's names, numbers, symbols and descriptions are used for reference only. It is not implied that any part listed is the product of these manufacturers.

# O-RING

121210

[050644](#)



BOOST PRESSURE SENSOR KIT

[050656](#)



OIL PRESSURE SENSOR

[050659](#)



PRESSURE SENSOR KIT (EGR)

[050676](#)



TEMPERATURE SENSOR KIT

[121438](#)

FUEL PUMP SERVICE KIT

[131263](#)

LOWER GASKET SET

[131482-100](#)

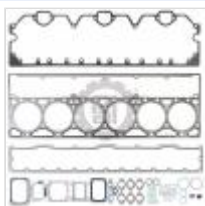

UPPER GASKET KIT

[131482-150](#)

FUEL O-RING KIT

[131608](#)

LOWER GASKET KIT

[131639](#)



LOWER GASKET KIT

Copyright © 2020 PAI Industries, Inc.  
 All rights reserved. All content is property of PAI Industries, Inc. and may not be reproduced or redistributed in any form.

Any reference to OEM names or OEM product identification numbers/descriptions/model numbers is for identification only and does not indicate that it is an OEM part. PAI is not affiliated with Mack Truck, Inc.®, Volvo®, Fuller®, Cummins®, Eaton®, Rockwell®, Caterpillar®, Freightliner®, Hendrickson®, Kenworth®, Detroit Diesel®, International®, Peterbilt®, or Dana®. All Manufacturer's names, numbers, symbols and descriptions are used for reference only. It is not implied that any part listed is the product of these manufacturers.

# O-RING

121210

[131640](#)



LOWER GASKET KIT

[131685](#)

LOWER GASKET KIT

[131722](#)

LOWER GASKET SET

[131726](#)



LOWER GASKET KIT

[131734](#)

UPPER GASKET KIT

[131739](#)

LOWER GASKET KIT

[131743](#)



UPPER GASKET KIT

[131746](#)



LOWER GASKET KIT

[131799](#)

LOWER GASKET KIT

[131811](#)

LOWER GASKET KIT

[131814](#)



UPPER GASKET KIT

[131830](#)











LOWER GASKET SET

Copyright © 2020 PAI Industries, Inc.  
 All rights reserved. All content is property of PAI Industries, Inc. and may not be reproduced or redistributed in any form.

Any reference to OEM names or OEM product identification numbers/descriptions/model numbers is for identification only and does not indicate that it is an OEM part. PAI is not affiliated with Mack Truck, Inc.®, Volvo®, Fuller®, Cummins®, Eaton®, Rockwell®, Caterpillar®, Freightliner®, Hendrickson®, Kenworth®, Detroit Diesel®, International®, Peterbilt®, or Dana®. All Manufacturer's names, numbers, symbols and descriptions are used for reference only. It is not implied that any part listed is the product of these manufacturers.

# O-RING

121210

<a href="#">131865</a>		LOWER GASKET KIT
<a href="#">131875</a>		LOWER GASKET KIT
<a href="#">131899</a>		LOWER GASKET KIT
<a href="#">131899R</a>		LOWER GASKET KIT
<a href="#">131906</a>		UPPER GASKET KIT
<a href="#">132023</a>		GASKET COOLER KIT
<a href="#">132045-170</a>		BLOCK GASKET SUB KIT
<a href="#">450611</a>		TEMPERATURE SENSOR KIT

Cross Reference:	
Manufacturer	OEM Number
CUMMINS	3330202
CUMMINS	3678912
CATERPILLAR	6V6560
CUMMINS	4010519
CUMMINS	4921574

Copyright © 2020 PAI Industries, Inc.  
 All rights reserved. All content is property of PAI Industries, Inc. and may not be reproduced or redistributed in any form.

Any reference to OEM names or OEM product identification numbers/descriptions/model numbers is for identification only and does not indicate that it is an OEM part. PAI is not affiliated with Mack Truck, Inc.®, Volvo®, Fuller®, Cummins®, Eaton®, Rockwell®, Caterpillar®, Freightliner®, Hendrickson®, Kenworth®, Detroit Diesel®, International®, Peterbilt®, or Dana®. All Manufacturer's names, numbers, symbols and descriptions are used for reference only. It is not implied that any part listed is the product of these manufacturers.