



PAI MONTHLY NEWSLETTER - JANUARY 2020 EDITION

STAY CURRENT



World Tested. Performance Proven.

JANUARY 2020



STAY CURRENT

ISO 9001 CERTIFIED

JANUARY 2020

TABLE OF CONTENTS

Price Reduced	2
Feature Item	3
Sensors & Components	4
Cab & Chassis Components	5
Drive Train Components	6
Engine Components	7-10
Engine Kits	11
Additional New Items	12



STAY CURRENT

WORLD TESTED. PERFORMANCE PROVEN.

JANUARY 2020

PRICE REDUCED

PAI REFERENCE	OEM REFERENCE	DESCRIPTION
EIH-2012	MAK 45MD252	Inlet Hose
EEX-2056	MAK 104GC5203M	Exhaust Manifold
BSH-6764	MAK 68KH410P2	Axle
JKT-6928	DAN 250-70-18X	Retainer Kit
EPN-8023HP	MAK 182GC2223	Pin
CCA-9728	DAN 108935-82A	Clutch Assembly
EE34140	EAT 48922	Bushing
EE94210	EAT 95539	Gear Set
EE96210	EAT 127495	Drive Gear
EE96340	EAT 132443	Gear
EF26260	FUL 18439	Clutch
EM06620	MAK 575KB457	Shift Fork
045041	CUM 3335341	Injector Roller Pin
045056	CUM 3687058	Cooling Nozzle
050618	CUM 4032068	Sensor
050750	CUM 4383933	Sensor
131638	CUM 4955596	Gasket Set
141281E	CUM 3031959	Oil Pan Kit
141286E	CUM 4952780	Oil Pan
141287	CUM 3901049	Oil Pan
180891E	CUM 3936201	Belt Tensioner
209998X	CUM 4954434	Injector Assembly
331672	CAT 2585646	Cover Gasket
341372	CAT 2273006	Oil Pan
342130	CAT 3E2332	Elbow Fitting
351525	CAT 9N5461	Bushing
381231	CAT 1333359	Exhaust Manifold
401034	NAV 1841896C96	Cylinder Kit
450595	NAV 1839415C91	Sensor Kit
641295	N/A	Oil Pan Kit
681813E	DDC 23535017	Water Pump Assembly

PAI REFERENCE	OEM REFERENCE	DESCRIPTION
803407	MAK 8MY426M7	Shifter Boot Assembly
803867	MAK 20QS238	Site Glass
803875	MAK 8155731	Plate Deck Clamp



PAI Heavy Duty Oil Filters

World Tested . Performance Proven. - ISO 9001 : CERTIFIED

Detroit Diesel Full-Flow Lube Spin-on Oil Filter

Replaces Detroit Diesel 23518480 | WIX 51971 | FRAM PH7405A
NAPA 197 Luberfiner LFP2160



PRICE REDUCED

PAI Reference	OEM Reference
650510	DDC23527033
Overall Length: 9-15/16in	
Thread Size: 1 5/8in -12	
O.D.: 4-12/32in	
Application: Detroit Diesel Engines	
Gasket Included (1)	

**Keeps contaminants
away from the sensitive
parts of the engine**

**Highly Durable
and Reliable**

**Gasket provides a
secure seal between
the filter and engine**

**Improves
Engine Life**

TWO YEAR WARRANTY Unlimited Mileage





STAY CURRENT

WORLD TESTED. PERFORMANCE PROVEN.

JANUARY 2020

AIR & ELECTRICAL

CAB & CHASSIS

DRIVE TRAIN

ENGINE

SENSORS

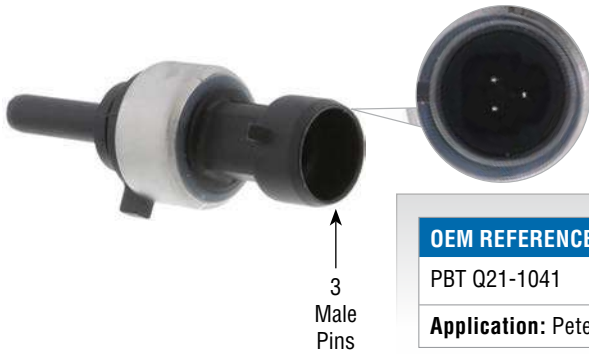

OEM REFERENCE	PAI REFERENCE	DESCRIPTION
PBT Q21-1041	730397	Air Pressure Sensor(2.64in OAL)
Application: Peterbilt / Kenworth		



OEM REFERENCE	PAI REFERENCE	DESCRIPTION
NAV 2593753C92	450625	Exhaust Temperature Sensor (M12 x 1.25)(45in OAL)
Application: International		



OEM REFERENCE	PAI REFERENCE	DESCRIPTION
NAV 3626432C1	450623	Exhaust Differential Pressure Sensor (2.78in OAL)
Application: International		



STAY CURRENT

ISO 9001 CERTIFIED

JANUARY 2020



OEM REFERENCE	PAI REFERENCE	DESCRIPTION
FTL A16-16057-000	741470	Rear Spring Shackle(Fits 3in Spring Leaf)
Application: Freightliner		



OEM REFERENCE	PAI REFERENCE	DESCRIPTION
MAK 4ME32972P17	803605	Exhaust Pipe(Aluminum)(Stack Pipe) (5in OD)(72in OAL)
Application: Mack DM / DMM & U Models		

AIR & ELECTRICAL

CAB & CHASSIS

DRIVE TRAIN

ENGINE

SENSOR



STAY CURRENT

WORLD TESTED. PERFORMANCE PROVEN.

JANUARY 2020



Front View



Rear View

OEM REFERENCE	PAI REFERENCE	DESCRIPTION
DAN 155698-6	EM97560	Clutch Plate(15-1/2in)
Application: Dana Multiple		



OEM REFERENCE	PAI REFERENCE	DESCRIPTION
FUL 4301964	900404	Splitter Piston
Application: Fuller 16709 / 16913 / 18909 / 18913 Series		

AIR & ELECTRICAL

CAB & CHASSIS

DRIVE TRAIN

ENGINE

SENSOR



STAY CURRENT

ISO 9001 CERTIFIED

JANUARY 2020



OEM REFERENCE	PAI REFERENCE	DESCRIPTION
CUM 3071228	042105	Water Transfer Tube(2.192in OAL)(1.30in I.D.)
Application: Cummins 855 / N14		



OEM REFERENCE	PAI REFERENCE	DESCRIPTION
CUM 3689565	141457	EGR Cooler(Includes Gaskets & O-Rings)
Application: Cummins ISX		



OEM REFERENCE	PAI REFERENCE	DESCRIPTION
CUM 3917700	181029	Exhaust Manifold
Application: Cummins 6B, 5.9L		

CAB & CHASSIS

DRIVE TRAIN

ENGINE

SENSOR



STAY CURRENT

WORLD TESTED. PERFORMANCE PROVEN.

JANUARY 2020

AIR & ELECTRICAL

CAB & CHASSIS

DRIVE TRAIN

ENGINE

SENSOR



OEM REFERENCE	PAI REFERENCE	DESCRIPTION
CUM 4299098	132040	Cylinder Head Gasket
Application: Cummins ISX		



OEM REFERENCE	PAI REFERENCE	DESCRIPTION
CUM 4975061	141341	Oil Pan Kit Includes Oil Pan & O-Ring Plugs
Application: Cummins ISX		



OEM REFERENCE	PAI REFERENCE	DESCRIPTION
CUM 5284141	191847	Camshaft Gear
Application: Cummins ISC		



STAY CURRENT

ISO 9001 CERTIFIED

JANUARY 2020



OEM REFERENCE	PAI REFERENCE	DESCRIPTION
N/A	631397	Upper Gasket Kit Includes Gaskets (1)631360 (DDC A5411870080) (1)631380 (DDC A4730960280) (6)631381 (DDC A4720980080) (1)631382 (DDC A4721421880) (1)631385 (DDC A4720980180) (1)631265 (DDC A4720161820) (1)631352 (DDC A4720160680) Coolant Tubes (2)691838 (DDC A4722000154) (1)691837 (DDC A4721400648) Injector Kits (6)621245 (DDC A4600700887) Washers (2)640092 (DDC N000000001069) (2)842031
Application: Detroit Diesel DD15		

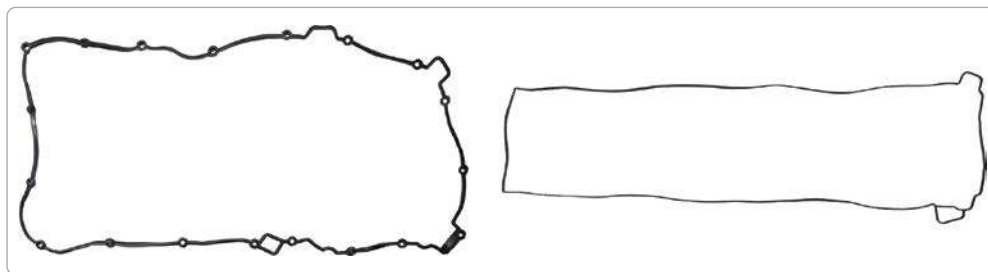

OEM REFERENCE	PAI REFERENCE	DESCRIPTION
N/A	631398	Valve Cover Gasket Kit Includes Gaskets (1)631366 (DDC A4720160121) (1)631352 (DDC A4720160680)
Application: Detroit Diesel DD15		

CAB & CHASSIS

DRIVE TRAIN

ENGINE

SENSOR



STAY CURRENT

WORLD TESTED. PERFORMANCE PROVEN.

JANUARY 2020

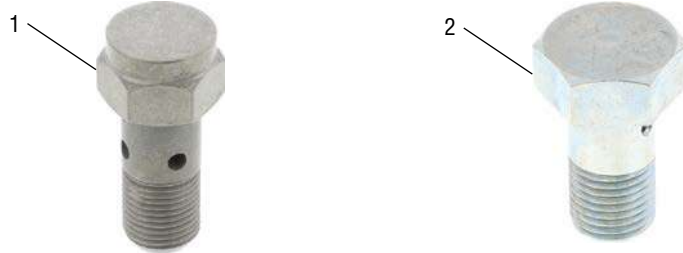

KEY	OEM REFERENCE	PAI REFERENCE	DESCRIPTION	APPLICATION
1	MAK 21458307	840071	Relief Valve M16 x 1.5 Thread	Mack & Volvo
2	MAK 20884328	840072	Relief Valve M14 x 1.5 Thread	



OEM REFERENCE	PAI REFERENCE	DESCRIPTION
MAK 85136428	841955	EGR Cooler Kit Includes EGR Cooler (1)841945 Seals (2)821071 EGR Clamps (2)842020 (2)803632 Hose (1)ECH-8529 Gaskets (2)831025
Application: Mack MP8 / Volvo D13		

AIR & ELECTRICAL

CAB & CHASSIS

DRIVE TRAIN

ENGINE

SENSOR



STAY CURRENT

ISO 9001 CERTIFIED

JANUARY 2020

NEW AVAILABLE ENGINE KITS

OEM REFERENCE	PAI REFERENCE	APPLICATION
CUM 4352392	ISX106-145	Cummins ISX



STAY CURRENT

WORLD TESTED. PERFORMANCE PROVEN.

JANUARY 2020

ADDITIONAL NEW ITEMS

PAI REFERENCE	OEM REFERENCE	DESCRIPTION
040119	CUM 3945097	Cup Plug
040156	CUM 3939409	Rod Bolt
042046	CUM 4946823	V-Band Clamp
042049	CUM 5450793	V-Band Clamp
050567	CUM 4992508	Drain Plug
132050	CUM 4032401	Gasket Kit
171656	CUM 3939407	Connecting Rod
172058	CUM 4938947	Main Bearing
331682	CAT 9L8027	Gasket
331686	CAT 9N0241	Gasket
331687	CAT 9N5429	Gasket
331690	CAT 9N1828	Gasket
331697	CAT 9N3354	Gasket
331698	CAT 7C2230	Gasket
331699	CAT 9L6467	Gasket
340039	CAT 0S1619	Screw
340040	CAT 8S9191	Screw
345035	CAT 2L5893	Roll Pin
410021HP	NAV 1818552C1	Piston Pin
600931	DDC 23536685	Cylinder Kit
631388	DDC A4720160780	Gasket
640048	DDC 23522327	Screw
640049	DDC 23522329	Screw
805050E	MAK 20747511	Ring Set
821087	VOL 976068	O-Ring
831054	MAK 50KH247	Gasket
900427	FUL 4303773	Rotor Retainer

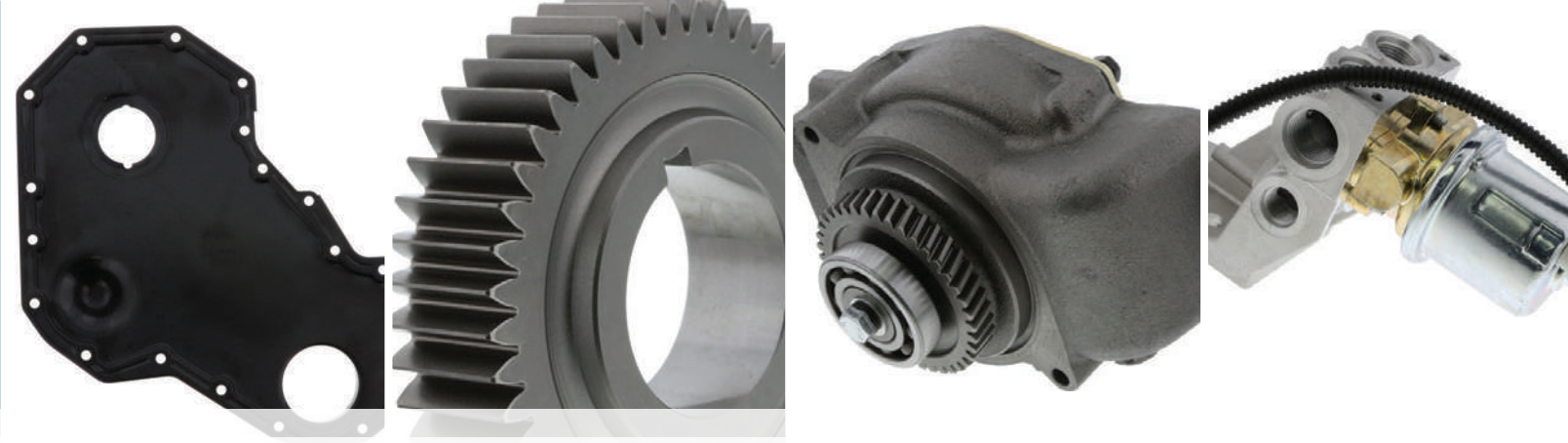

PAI MONTHLY NEWSLETTER - FEBRUARY 2020 EDITION

STAY CURRENT



World Tested. Performance Proven.

FEBRUARY 2020



STAY CURRENT

ISO 9001 CERTIFIED

FEBRUARY 2020

TABLE OF CONTENTS

Price Reduced	2
Feature Item	3
Sensors & Components	4-5
Now Available in Excel	6
Drive Train Components	7
Engine Components	8-11
Additional New Items	12



STAY CURRENT

WORLD TESTED. PERFORMANCE PROVEN.

FEBRUARY 2020

PRICE REDUCED

PAI REFERENCE	OEM REFERENCE	DESCRIPTION
EOP-2045	MAK 240GB5263M6	Oil Pan
FHL-5248	MAK 2M0525AM	Headlamp Assembly
FHL-5249	MAK 2M0526AM	Headlamp Assembly
BBK-7125A	MAK 205SP73A	Bearing Kit
ECH-8751	MAK 744GB252	Hose
EM79610	MAK 56KH3154P2	Gear
050787	CUM 5400509	Sensor
141431	CUM 4965487	Cooler Core
171987	CUM 4089846	Main Bearing Kit
431375	N/A	Gasket Kit
451486	NAV 1878209C3	Cam Bearing
451489	NAV 1842053C1	Cam Bearing
451491	NAV 675424C1	Cam Bearing
671680	DDC 5149452	Rod Bearing
691934E	DDC 8929127	Valve Seat
803715	MAK 800-6222084001	Seat Air Spring Kit
803833	MAK 97QL5119M	Bracket Assembly
803868	VOL 3966106	Surge Tank
841202	MAK 240GB5263M5	Oil Pan
841203	MAK 240GB5263M7	Oil Pan
900018	FUL 4302529	Mainshaft Gear
900044HP	FUL 22370	Mainshaft Gear
900130	FUL 4305996	Sliding Clutch
ERK-8035-001	MAK 215SB208B	Engine Kit
ERK-8035-002	N/A	Engine Kit
ERK-8035-003	N/A	Engine Kit
ERK-8035-005	N/A	Engine Kit
ERK-8035-006	N/A	Engine Kit
ERK-8035-007	N/A	Engine Kit
ERK-8035-009	N/A	Engine Kit
ERK-8035-010	N/A	Engine Kit

PAI REFERENCE	OEM REFERENCE	DESCRIPTION
ERK-8035-011	N/A	Engine Kit
ERK-8035-014	N/A	Engine Kit
ERK-8035-016	N/A	Engine Kit



DD15[®] Engine Kit

World Tested . Performance Proven. - ISO 9001: CERTIFIED

Detroit DD15[®]

The most complete and specialized kit for your engine

Detroit Diesel DD15[®] Engine Kit

DD1501-145

Customer ESN required to confirm correct Engine Kit.



DD15 Cylinder Kit
PAI Ref. 600961

PAI Premium DD15 Engine Kit	Includes High Performance Pins, and Bearings
Cylinder Kit includes (APR) Anti-Polishing Ring Liner	Includes 3rd Generation OEM designed Head Gasket.

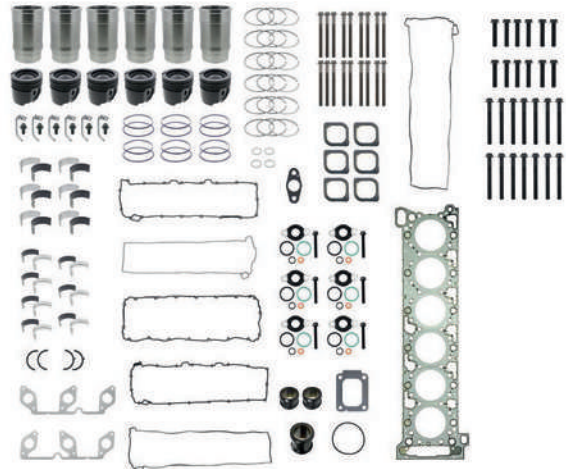

DD1501-145 DD15 Inframe Kit w/ APR Liner

PAI Ref.	OEM Ref.	Description	Qty.
671585A ^{HP}	N/A	Main Bearing Kit	1
671575A ^{HP}	N/A	Rod Bearings Kit	1
631359	4720140322	Oil Pan Gasket Kit	1
* 631398	N/A	Valve Cover + Rocker Gasket Set	1
* 631399	N/A	Valve Cover + Rocker Gasket Set	1
631400	N/A	Head Gasket Set	1
640038-019	A4720160169	Screw	2
640055	A4720380071	Rod Bolts	12
640056	A0000111071	Main Bolts	14
600961	N/A	Cylinder Kits	6

* Two optional Valve Cover plus Rocker Gasket Sets included. Must match upper Rocker Box being used.

Gasket Set 631398 includes part numbers 631366 & 631352

Gasket Set 631399 includes part numbers 631396 & 631388

^{HP} Available in High Performance

TWO YEAR ^{WARRANTY} Unlimited Mileage



STAY CURRENT

WORLD TESTED. PERFORMANCE PROVEN.

FEBRUARY 2020

AIR & ELECTRICAL

CAB & CHASSIS

DRIVE TRAIN

ENGINE

SENSORS



3 Male Pins

OEM REFERENCE	PAI REFERENCE	DESCRIPTION
CUM 4921730	050739	Differential Pressure Sensor(2.29in OAL)
Application: Cummins Multiple		

M18 x 1.5 Thread with High Temperature Antiseize Compound



4 Male Pins

OEM REFERENCE	PAI REFERENCE	DESCRIPTION
CUM 5400509	050787	Oxygen Sensor(34in Lead Length)
Application: Cummins Multiple		

Heat Resistant Material



2 Male Pins

OEM REFERENCE	PAI REFERENCE	DESCRIPTION
CUM 5550063	050615	Turbo Speed Sensor Kit (34.5in OAL) Includes Sensor (1)050614 Screw (1)040077 Harness Clip (1)121130
Application: Cummins Multiple		



STAY CURRENT

ISO 9001 CERTIFIED

FEBRUARY 2020

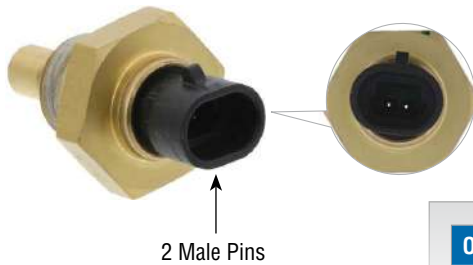

OEM REFERENCE	PAI REFERENCE	DESCRIPTION
FTL 22-54800-001	740229	Coolant Temperature Sensor(2.20in OAL) (3/4in-16 Threads w/ Locking Compound) Includes O-Ring (1)121379
Application: Freightliner Multiple		



OEM REFERENCE	PAI REFERENCE	DESCRIPTION
PBT 5549-53715-36	730414	Fuel Level Sensor (12in Arm Length)(13.50in Tube Length)
Application: Kenworth / Peterbilt Multiple		

AIR & ELECTRICAL

CAB & CHASSIS

DRIVE TRAIN

ENGINE

SENSORS



STAY CURRENT

WORLD TESTED. PERFORMANCE PROVEN.

FEBRUARY 2020

NOW AVAILABLE IN EXCEL



OEM REFERENCE	PAI REFERENCE	DESCRIPTION
CAT 1727760	381810E	Water Pump Assembly
Application: Caterpillar 3306		



OEM REFERENCE	PAI REFERENCE	DESCRIPTION
CAT 1727776	381811E	Water Pump Assembly
Application: Caterpillar 3304 / 3306		



STAY CURRENT

ISO 9001 CERTIFIED

FEBRUARY 2020



OEM REFERENCE	PAI REFERENCE	DESCRIPTION
FUL 4302422	900649	Countershaft Gear(3rd)(C Ratio)(45 Teeth)
Application: Fuller 13210 / 14210 / 15210 / 16210 / 17210 / 18210 Series		



OEM REFERENCE	PAI REFERENCE	DESCRIPTION
FUL K-4124	900662	Clutch Installation Kit Includes Pinion Assembly (1)900090 Cover (1)EF69470 Bearing (1)EBG-8688HP Roller Bearing (1)EM89660 Brake (1)EM96900 Ring (1)EF27470 Yoke (1)900435 Capscrew (2)900591 Gasket Kit (1)900171 Retaining Ring (1)900220
Application: Fuller Multiple		

AIR & ELECTRICAL

CAB & CHASSIS

DRIVE TRAIN

ENGINE

SENSOR



STAY CURRENT

WORLD TESTED. PERFORMANCE PROVEN.

FEBRUARY 2020



OEM REFERENCE	PAI REFERENCE	DESCRIPTION
CUM 4089997	060083	Timing Gear Cover Assembly
Application: Cummins ISM / L10		



OEM REFERENCE	PAI REFERENCE	DESCRIPTION
CUM 4352145	132058	Upper Gasket Kit
Application: Cummins ISX		



OEM REFERENCE	PAI REFERENCE	DESCRIPTION
CUM 5362271	180128	Fuel Transfer Pump Assembly Includes Transfer Pump (1)180115 Pump Support (1)180146 Harness (1)050711
Application: Cummins ISX		

AIR & ELECTRICAL

CAB & CHASSIS

DRIVE TRAIN

ENGINE

SENSOR



STAY CURRENT

ISO 9001 CERTIFIED

FEBRUARY 2020

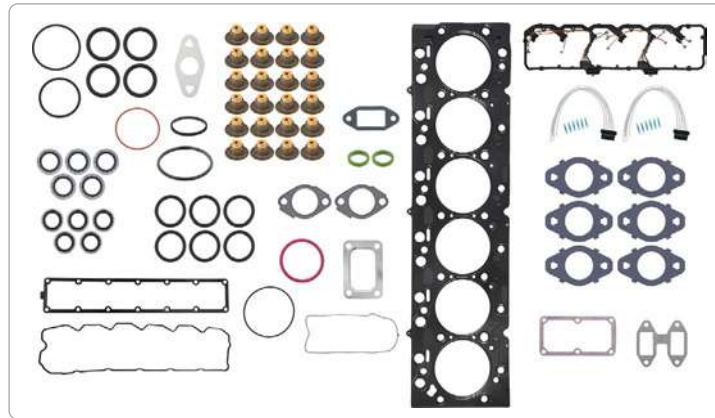

OEM REFERENCE	PAI REFERENCE	DESCRIPTION
CUM 4376090	132049	Upper Gasket Kit

Application: Cummins ISB / QSB



OEM REFERENCE	PAI REFERENCE	DESCRIPTION
N/A	181050	Exhaust Manifold Assembly Includes Manifold Assembly (1) Gaskets (1)131306 (1)131370 (3)131400 Turbo Hose (1)045001 Nuts (4)040062 Studs (4)340117 Screws (12)040027

Application: Cummins N14

CAB & CHASSIS

DRIVE TRAIN

ENGINE

SENSOR



STAY CURRENT

WORLD TESTED. PERFORMANCE PROVEN.

FEBRUARY 2020

AIR & ELECTRICAL

CAB & CHASSIS

DRIVE TRAIN

ENGINE

SENSOR



OEM REFERENCE	PAI REFERENCE	DESCRIPTION
N/A	340092	Exhaust Manifold Kit Includes Exhaust Gaskets (6)331457 (CAT 2832238) Nuts (12)340062 (CAT X6620) Studs (9)340115 (CAT 1163715) (4)340117 (CAT 2459750) (2)340118 (CAT 2245445) (1)340119 (CAT 2245422) Spacers (9)340136 (CAT 4P4369) (2)340137 (CAT 2245450)

Application: Caterpillar C13



OEM REFERENCE	PAI REFERENCE	DESCRIPTION
DDC A4600700987	621249	Fuel Injector O-Ring Kit

Application: Detroit Diesel DD13 / DD15



STAY CURRENT

ISO 9001 CERTIFIED

FEBRUARY 2020

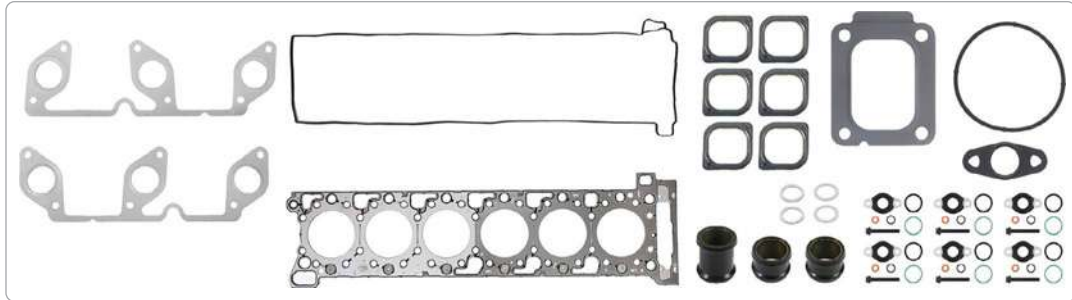

OEM REFERENCE	PAI REFERENCE	DESCRIPTION
N/A	631400	Cylinder Head Gasket Kit Includes Head Set (1)631375 (DDC A4720162120) Intake Gasket Kit (1)631400-151 Exhaust Gasket Kit (1)631400-152
Application: Detroit Diesel DD15		

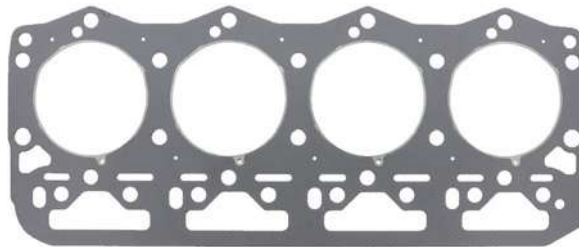

OEM REFERENCE	PAI REFERENCE	DESCRIPTION
NAV 1826672C1	431370	Cylinder Head Gasket
Application: International 7.3 / 444		

CAB & CHASSIS

DRIVE TRAIN

ENGINE

SENSOR



STAY CURRENT

WORLD TESTED. PERFORMANCE PROVEN.

FEBRUARY 2020

ADDITIONAL NEW ITEMS

PAI REFERENCE	OEM REFERENCE	DESCRIPTION
042167	CUM 3688114	Cover Plug
045140	CUM 3895718	Retainer Plug
111516HP	CUM 3973265	Piston
111760	CUM 4943105	Piston
132046	CUM C6204611660	Gasket
191849	CUM 3022352	Camshaft Key
192174	CUM 5448124	Valve Guide Seal
321490	CAT 2392402	O-Ring
331683	CAT 9L7630	Gasket
331685	CAT 1097279	Gasket
331693	CAT 9N6098	Gasket
336066	CAT 8S7762	Seal
336068	CAT 8S8821	Seal
440116	NAV 1818601C1	Stud
442072	NAV 1820813C1	Dowel Pin
505099E	CUM 4089385	Piston Ring Set
505139HP	CUM 4089644	Piston Ring Set
505185E	CUM 4025290	Piston Ring Set
505194	CUM 3973242	Top Ring
505195	CUM 4089933	Piston Ring Set
605084	DDC A4720300624	Piston Ring Set
611036HP	DDC 23533041	Piston
811003	VOL 3155115	Piston Pin
811030	VOL 20440962	Piston
821088	VOL 20974821	O-Ring
821089	VOL 20365079	Rectangular Ring
821090	VOL 21532261	Rectangular Ring
836045	VOL 20591445	Seal
840038	MAK 20706537	Bolt
940048	ROK 1244M2041	Spacer

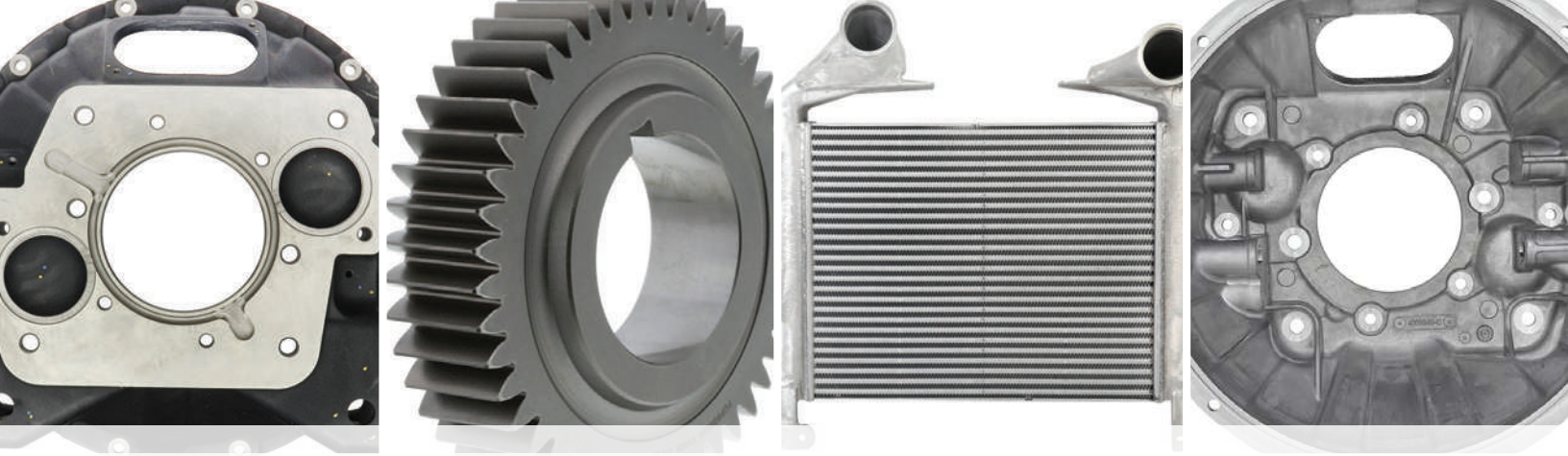

PAI MONTHLY NEWSLETTER - MARCH 2020 EDITION

STAY CURRENT



World Tested. Performance Proven.

March 2020



STAY CURRENT

ISO:9001 CERTIFIED

Table of Contents

Price Reduced	2
Feature Item	3
Air & Electrical Components	4-5
Cab & Chassis Components	6
Drive Train Components	7
Engine Components	8-11
Additional New Items	12



STAY CURRENT

WORLD TESTED. PERFORMANCE PROVEN.

Price Reduced

PAI Reference	OEM Reference	Description
LCV-3409	MAK 20QE2373	Control Valve
GBK-6140	MAK 208SH85	Bearing Kit
EBG-8330-P1	MAK 62GB2382P1	Bearing
EBG-8330-P10	MAK 62GB2382P10	Bearing
EBG-8330-P20	MAK 62GB2382P20	Bearing
EF89530	FUL 4304510	Main Drive Gear
050692	CUM 4984787	Oil Pressure Switch
131267	CUM 2864080	Head Gasket
131337	CUM 3801468	Gasket Set
131653	CUM 3685834	Cylinder Head Gasket
141431	CUM 4965487	Cooler Core
141432	CUM 4955831	Oil Cooler Kit
360460E	CAT 2237263	Cylinder Head
360462E	CAT 2635055	Cylinder Head
410029	NAV 1878102C2	Piston Pin
601000C	DDC 23531598	Engine Kit
621242	DDC 23537111	Fuel Injector Kit
631282	DDC 23522269	Valve Cover Gasket
640038	DDC A4720160169	Cylinder Head Bolts
640038-019	DDC A4720160169	Cylinder Head Bolts(19 pcs)
640039	DDCN000000004898	Banjo Bolt
640055	DDC A4720380071	Bolt
640056	DDC A0000111071	Bolt
640063	DDC 11509511	Screw
661614	DDC 23531250	Liner Kit
681832	DDC A4722000115	Thermostat
801100	MAK 134GB385M	Fan Hub Assembly
801178	MAK 21367720	Cylinder Kit
803832	MAN M1211	Trunnion Bracket Assembly
803833	MAK 97QL5119M	Trunnion Bracket Assembly
803867	MAK 20QS238	Site Glass

PAI Reference	OEM Reference	Description
804194	MAK 48MO429BM	Fog Lamp
805026	MAK 634GC5337M2	Flywheel Housing
821020	MAK 276948	O-Ring Kit
842015	MAK 9MD47	Fuel Tank Strap
842027	MAK 85124753	Clamp Kit
D11101-001	N/A	Engine Kit
MP7101-001	N/A	Engine Kit
MP7101-008	N/A	Engine Kit



STAY CURRENT

ISO:9001 CERTIFIED

Cummins® N14 New One-Piece Manifold Design

This unique designed PAI Exhaust Manifold is sold as a complete kit that includes the Front, Center and Rear pieces as a single unit.

Cummins® N14 1pc. Exhaust Manifold w/Mounting Kit

PAI Ref. 181050



Also available in High Performance
181050HP with a 3-Year Warranty

TWO YEAR WARRANTY Unlimited Mileage

Cummins N14 181050 Exhaust Manifold Kit

PAI Ref.	OEM Ref.	Description	Qty.
181050	N/A	Exhaust Manifold Kit	1
Exhaust Mounting Kit Includes			
131370	3069177	Turbo Mounting Gasket	1
131400	3865235	Exhaust Manifold Gasket	3
131306	216487	Crossover Gasket	1
045001	202994	Turbo Hose	1
040062	3818824	Turbo Mounting Nut	4
340117	2459750	Turbo Mounting Stud	4
040027	3067930	Screw & Spacer Assembly	12



One-Piece Design
Front, Center, and Rear Pre-Assembled

Mounting Kit Included
PAI Ref. 181011



STAY CURRENT

WORLD TESTED. PERFORMANCE PROVEN.



OEM Reference	PAI Reference	Description
BEN 800361	802523	Governor(105-130 psi) (Non-Adjustable)
Application: Multiple		



OEM Reference	PAI Reference	Description
HAL 90054088	802645	2 Way Manual Valve(1/8in NPT Port) (Suspension Dump)
Application: Multiple		



OEM Reference	PAI Reference	Description
HAL 90554107	802649	Pressure Protection Valve (75 psig Crack)(70 psig Re-Seat) (1)1/4in-18 Flow In Port (1)1/4in-18 Flow Out Port
Application: Multiple		

Air & Electrical

Cab & Chassis

Drivetrain

Engine

Sensors



STAY CURRENT

WORLD TESTED. PERFORMANCE PROVEN.



OEM Reference	PAI Reference	Description
SEO 110205	802552	Emergency Relay Valve (4)3/8in NPT Delivery Ports (1)3/4in NPT Reservoir Port (2)3/8in NPT Supply Ports
Application: Multiple		



OEM Reference	PAI Reference	Description
SEO 110570	802553	Emergency Relay Valve (Includes Mounting Bracket) (2)3/8in-18 Delivery Ports (1)3/8in-18 Control Port (1)1/2in-14 Supply Port
Application: Multiple		



OEM Reference	PAI Reference	Description
SEO 110800	802583	Spring Brake Control Valve (Aluminum) (4) 3/8in-18 NPT Delivery Ports (1) 3/8in-18 NPT Supply Ports (1) 1/2in-14 NPT Reservoir Port (1) 3/8in-18 NPT Control Port
Application: Multiple		

Air & Electrical

Cab & Chassis

Drivetrain

Engine

Sensors



STAY CURRENT

WORLD TESTED. PERFORMANCE PROVEN.



OEM Reference	PAI Reference	Description
MAK 21016740	841989	Intercooler Core(Chassis Mount) (24.75in Wide)(20.25in Height) (3.02in Thick) (Inlet 3.93in / Outlet 3.93in)
Application: Mack MR / MU Models		



OEM Reference	PAI Reference	Description
N/A	803863	Surge Tank Kit Includes: Coolant Tank (1)FTK-3398 Tank Strap (1)842015 Cap (1)ERC-8382 Insulators (2)803877-001 Washers (2)841251 Nut(1)840138 Mounting Bracket (1)803876 Cable Ties (1)831119 (10)831118 Plug (1)FPP-3577 Hose (1)840144-005 Fittings (1)840095 (1)840109
Application: Mack CT / CTP / CV / CX / CXP / CXN / CXU Models		

Air & Electrical

Cab & Chassis

Drivetrain

Engine

Sensors



STAY CURRENT

ISO:9001 CERTIFIED



OEM Reference	PAI Reference	Description
FUL K-2183	900180	Mainshaft & Countershaft Shim Kit
Application: Fuller Mid Range Multiple		



Back



Front

OEM Reference	PAI Reference	Description
FUL K-3672	900711	Clutch Housing (#1 Pull Iron Housing)
Application: Fuller Multiple		



OEM Reference	PAI Reference	Description
FUL 4302670	900030HP	High Performance Mainshaft Gear
Application: Fuller 18718		

Air & Electrical

Cab & Chassis

Drivetrain

Engine

Sensors



STAY CURRENT

WORLD TESTED. PERFORMANCE PROVEN.

Air & Electrical



OEM Reference	PAI Reference	Description
N/A	040107	Block Plug Kit Includes Plugs (4)040084 (6)040093 (4)040086 (1)040090 (4)040089 (4)GCP-3484 (1)GCP-3495 (3)ECP-3487
Application: Cummins ISB		

Cab & Chassis



OEM Reference	PAI Reference	Description
CUM 3084533	172034	Idler Gear Assembly Includes Gear (1)172033 and Bushing (1)151520
Application: Cummins ISM / M11		

Drivetrain



OEM Reference	PAI Reference	Description
CUM 3965548	132047	Valve Cover Gasket
Application: Cummins ISC		

Engine



OEM Reference	PAI Reference	Description
CUM 3892697	060084	Gear Cover
Application: Cummins ISM / M11 / QSM		

Sensors



STAY CURRENT

ISO:9001 CERTIFIED



OEM Reference	PAI Reference	Description
CUM 3937477	181037	Rear Exhaust Manifold
Application: Cummins 6C 8.3L / ISC / ISL / QSC		



OEM Reference	PAI Reference	Description
CUM 4089431	180132	Fuel Pump Assembly Includes Gasket (1)131931
Application: Cummins ISX / ISX15		



OEM Reference	PAI Reference	Description
CUM 5529493	132048	Upper Gasket Kit
Application: Cummins ISL		

Air & Electrical

Cab & Chassis

Drivetrain

Engine

Sensors



STAY CURRENT

WORLD TESTED. PERFORMANCE PROVEN.



OEM Reference	PAI Reference	Description
CUM 4352144	132057	Upper Gasket Kit
Application: Cummins ISX		



OEM Reference	PAI Reference	Description
NAV 1830826C93	431369	Cylinder Head Gasket Kit Includes Head Gaskets (2)431370 Valve Seals (16)492008
Application: International 7.3 / 444		

Air & Electrical

Cab & Chassis

Drivetrain

Engine

Sensors



STAY CURRENT

ISO:9001 CERTIFIED

New Engine Kits Available

OEM Reference	PAI Reference	Application
N/A	ISC103-001HP	Cummins ISC Series
N/A	4BS114-076	Cummins 4B Series
N/A	6BS114-076	Cummins 6B Series
N/A	DD1501-145HP	Detroit Diesel DD15 Series



STAY CURRENT

WORLD TESTED. PERFORMANCE PROVEN.

Additional New Items

PAI Reference	OEM Reference	Description
040062F	DDC 11506101	Turbocharger Nut
040110F	DDC 23507438	Turbocharger Stud
336065	CAT 2624378	Water Pump Seal
342142	PKR 8F5OX-S	Fitting
605084HP	DDC A4720300624	Piston Ring Set
611071HP	N/A	Piston Kit
445012	NAV 1889117C93	Piston Kit
470100HP	NAV 1822389C91	Rod Bearing
470110HP	NAV 1822321C91	Main Bearing
470115HP	NAV 1822379C91	Main Bearing
845012	MAK 20737856	Intake Valve
845013	MAK 20564020	Exhaust Valve
845043	MAK 20737849	Intake Seat
845044	MAK 20732758	Exhaust Seat



PAI MONTHLY NEWSLETTER - APRIL 2020 EDITION

STAY CURRENT



World Tested. Performance Proven.

APRIL 2020



STAY CURRENT

ISO:9001 CERTIFIED

Table of Contents

Price Reduced	2-3
Feature Item	4
Now Available in Excel	5
Cab & Chassis Components	6
Drive Train Components	7
Engine Components	8-10
New Available Engine Kits	11
Additional New Items	12



STAY CURRENT

WORLD TESTED. PERFORMANCE PROVEN.

Price Reduced

PAI Reference	OEM Reference	Description
ECL-1845	MAK 83AX870	Clamp
ECL-1944	MAK 83AX868	Clamp
FBG-4619	MAK 10QK158A	Bushing
HBS-5442	NTN SET426	Cup & Cone Set
GGB-6321	MAK 751KB223B	Gear
EPR-8312	MAK 353GC2134	Piston Ring Set
EMS-8570-P10	MAK 215SB72CP2	Bearing Kit
EE09460	EAT 113745	Shift Motor
EF59560	FUL 4303420	Gear
EF59560HP	FUL 4303420	Mainshaft Gear
EF62910HP	FUL 19623	HP Countershaft Gear
EM19420	MAK 11ME229P6	Clamp
EM36100	MAC 5396-KN30400	Valve
EM50120	BEN 278305	Slack Adjuster
EM63210	MAK 751KB223	Gear
EM67900	MAK 61KH47AP7	Bull Gear
EM79620	MAK 56KH434A	Helical Pinion
EM97600	MAK 101HB463AP1	Clutch Disc
EM97680	MAK 2104-128215	Clutch Disc
EM97700	MAK 101HB462AP1	Clutch Disc
EM97780	MAK 2104-128216	Clutch Disc
ER75690	ROK 2233-J-1024	Pinion
040115	CUM 4298975	Nut
050701	CUM 4921601	Crankshaft Sensor
111612	CUM 4025072	Piston Ring Kit
132032	CUM 2880214	Exhaust Gasket
180190	CUM 3408324	Fuel Actuator
192075	CUM 3046418	Pushrod
202004	CUM 3925568	Crankshaft Damper
301027	N/A	Cylinder Kit
301027HP	N/A	Cylinder Kit

PAI Reference	OEM Reference	Description
311195	N/A	Piston Kit
311195HP	N/A	HP Piston Kit
390016	CAT 1225053	Solenoid Valve
431307	NAV 1842126C91	Gasket Kit
440040	NAV 30360R1	Bolt
480226X	NAV 1842721C91	High Pressure Pump
497262	NAV MAS65466	Shock Absorber
621239	DDC 23537123	O-Ring Kit
640015	DDC 23530768	Head Bolt
640015-019	DDC 23530768	Head Bolt(19 Pieces)
641212	DDC 23527448	Oil Pump
680305	DDC 23515354	Turbo Oil Drain Line
680306	DDC 23518514	Turbo Oil Drain Line
681812E	DDC 23526039	Water Pump Assembly
801088	MAK 85118917	Fuel Pump Kit
801135	MAK 316GC3194	Water Pump Kit
801137	MAK 316GC3195	Water Pump Kit
801141	MAK 379GC318	Water Pump Rotor
801178	MAK 21367720	Cylinder Kit
806865	N/A	Synchro Update Kit
803873	MAK 4QM281M	Hood Bushing
803963	MAK 2795-170014005	Window Felt
845076	VOL 21508269	Speed Sensor
891915E	MAK 454GC5238	Camshaft Kit
891922	MAK 20742607	Camshaft
891924	MAK 20920956	Camshaft
891925	MAK 21198713	Camshaft
891931E	MAK 57GC2228A	Camshaft Kit
940630	ROK A-3280-F-9392	Solenoid Valve
466103-001	NAV 1850011C91	Engine Kit
466103-002	N/A	Engine Kit



STAY CURRENT

ISO:9001 CERTIFIED

Price Reduced

PAI Reference	OEM Reference	Description
466103-005	N/A	Engine Kit
466103-006	N/A	Engine Kit
466103-007	N/A	Engine Kit
466103-008	N/A	Engine Kit
466103-009	N/A	Engine Kit
466103-010	N/A	Engine Kit
466103-011	N/A	Engine Kit
466103-014	N/A	Engine Kit
466103-015	N/A	Engine Kit
466103-016	N/A	Engine Kit
466103-501	N/A	Engine Kit
C15107-010	N/A	Engine Kit
C15107-010HP	N/A	Engine Kit
C15107-028HP	N/A	Engine Kit
D11101-001	N/A	Engine Kit
ISB410-076	N/A	Engine Kit
ISB410-101	N/A	Engine Kit
ISB610-076	N/A	Engine Kit
ISB610-082	N/A	Engine Kit
ISB610-112	N/A	Engine Kit
MP7101-001	N/A	Engine Kit
MP7101-008	N/A	Engine Kit



STAY CURRENT

WORLD TESTED. PERFORMANCE PROVEN.

Featured Item: Detroit Diesel DD15 Engine Bolts

It is recommended to replace these high strength bolts with every overhaul. Reusing old bolts can cause the bolts to stretch and cause catastrophic failures. Why take chances on your DD15 engine? PAI high strength bolts are Made in the USA and ensure a perfect torque each time.

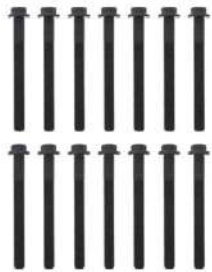

PAI Ref.	OEM Ref.	Description
640056	A0000111071	Main Cap Bolts
Application: Detroit Diesel DD15 Kit Requires 14		



PAI Ref.	OEM Ref.	Description
640038-019	A4720160169	Cylinder Head Bolts
Application: Detroit Diesel DD15 Kit Requires 38		

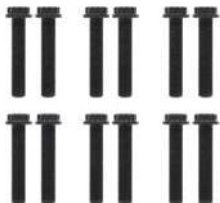

PAI Ref.	OEM Ref.	Description
640055	A4720380071	Rod Cap Bolts
Application: Detroit Diesel DD15 Kit Requires 12		

Made in the USA

OEM Recommended Specs

High-Grade Material

Torque to Yield Rod Bolts

2-Year Warranty

TWO YEAR WARRANTY Unlimited Mileage





STAY CURRENT

WORLD TESTED. PERFORMANCE PROVEN.

Now Available in Excel



OEM Reference	PAI Reference	Description
N/A	181929E	Water Pump Kit Includes O-Ring (1)121315
Application: Cummins ISX		

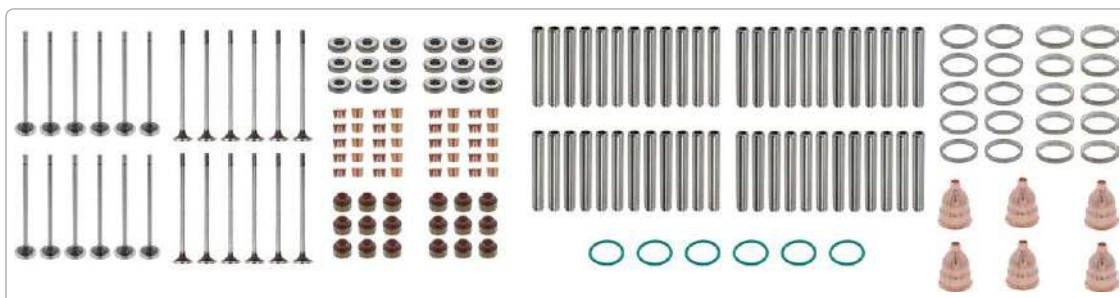

OEM Reference	PAI Reference	Description
N/A	660011E	Cylinder Head Rebuild Kit Includes: Exhaust Valves (12)691912E Intake Valves (12)691908E Valve Rotators (12)691960 Valve Locks (24)691950 Valve Seals (12)692000 Intake Valve Seats (12)691934E Exhaust Valve Seats (1)691930E Valve Guides (24)692020E Injector Tube Kits (6)692084
Application: Detroit Diesel Series 60		



STAY CURRENT

WORLD TESTED. PERFORMANCE PROVEN.

Air & Electrical

Cab & Chassis

Drivetrain

Engine

Sensors



OEM Reference	PAI Reference	Description
MAK 349619	804094	Power Steering Filter
Application: Mack / Volvo Multiple		



OEM Reference	PAI Reference	Description
MAK 85153131	803862	Tank Cap
Application: Mack Multiple		



STAY CURRENT

ISO:9001 CERTIFIED



OEM Reference	PAI Reference	Description
N/A	808131	Nest Kit Includes Side Gears (2)BSG-2437 Gear (4)BSP-7460 Spider (1)BSD-0791HP Washers (2)BWA-3071 (4)BWA-3072
Application: Mack CRD150 / CRD151 Rear Differential - CRD 200/202 - CRD 201/203		



OEM Reference	PAI Reference	Description
ROK 3221-P-1004	940073	Oil Baffle(Non-Pump)
Application: Rockwell Multiple		

Air & Electrical

Cab & Chassis

Drivetrain

Engine

Sensors



STAY CURRENT

WORLD TESTED. PERFORMANCE PROVEN.



OEM Reference	PAI Reference	Description
CUM 3103836	050477	Serpentine Belt (90.50in Effective Length) (1.66in Wide)(12 Ribs)
Application: Cummins ISX		



OEM Reference	PAI Reference	Description
CUM 3915703	141284	Oil Pan
Application: Cummins 6B		



OEM Reference	PAI Reference	Description
CUM 4330744	181151	Flexible Oil Drain Tube
Application: Cummins Multiple		

Air & Electrical

Cab & Chassis

Drivetrain

Engine

Sensors



STAY CURRENT

ISO:9001 CERTIFIED

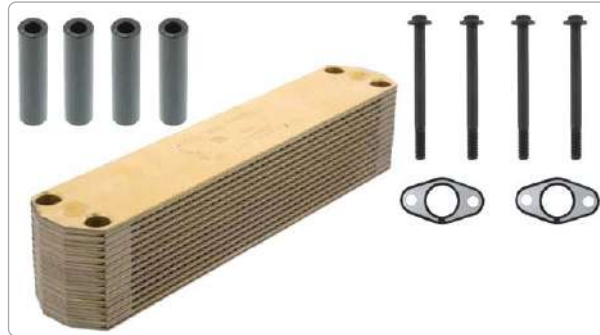

OEM Reference	PAI Reference	Description
CUM 4955831	141432	Oil Cooler Kit Includes Cooler Core (1)141431 Gasket (2)131641 Screws (4)040105 Spacers (4)040114
Application: Cummins Multiple		



Front View

Rear View

OEM Reference	PAI Reference	Description
DDC 23524001	680369	Accessory Drive(Includes O-Ring) (6 Groove Serpentine Pulley)
Application: Detroit Diesel Series 60		

Air & Electrical
Cab & Chassis
Drivetrain
Engine
Sensors



STAY CURRENT

WORLD TESTED. PERFORMANCE PROVEN.



OEM Reference	PAI Reference	Description
DDC A4720700887	609930X	Fuel Injector Assembly
Application: Detroit Diesel DD15		

Air & Electrical

Cab & Chassis

Drivetrain

Engine

Sensors

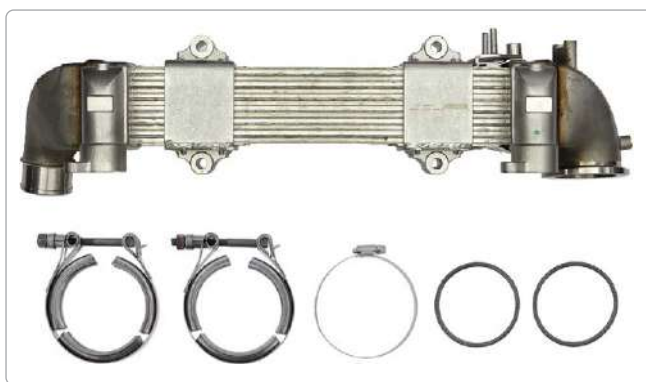

OEM Reference	PAI Reference	Description
VOL 20800118	841947	EGR Cooler
Application: Mack MP7 / Volvo D11		



OEM Reference	PAI Reference	Description
VOL 20911049	805061	Exhaust Manifold Kit
Application: Mack MP8 / Volvo D13		



STAY CURRENT

ISO:9001 CERTIFIED

New Engine Kits Available

OEM Reference	PAI Reference	Application
N/A	DD1551-145 (Pistonless)	Detroit Diesel DD15
CUM 4376178	ISX119-065	Cummins ISX



STAY CURRENT

WORLD TESTED. PERFORMANCE PROVEN.

Additional New Items

PAI Reference	OEM Reference	Description
311307	CAT 2W4831	Piston
381244	BCA 6207-2RS	Bearing
101027HP	CUM 3803346	HP Cylinder Kit
101106HP	CUM 4025162	HP Cylinder Kit
111129HP	CUM 3045948	HP Piston
111139HP	CUM 3069212	HP Piston
111265HP	CUM 3917707	HP Piston
171992HP	CUM 4090016	HP Rod Bearing
192173	CUM 3883512	Valve Retainer
192280	CUM 3685996	Intake Valve
671575AHP	N/A	HP Rod Bearing Kit
821025	MAK 1546790	Injector O-Ring
821027	MAK 1677319	Injector O-Ring
861616	VOL 20451502	Liner
920075	BCA 6209-2RS	Bearing

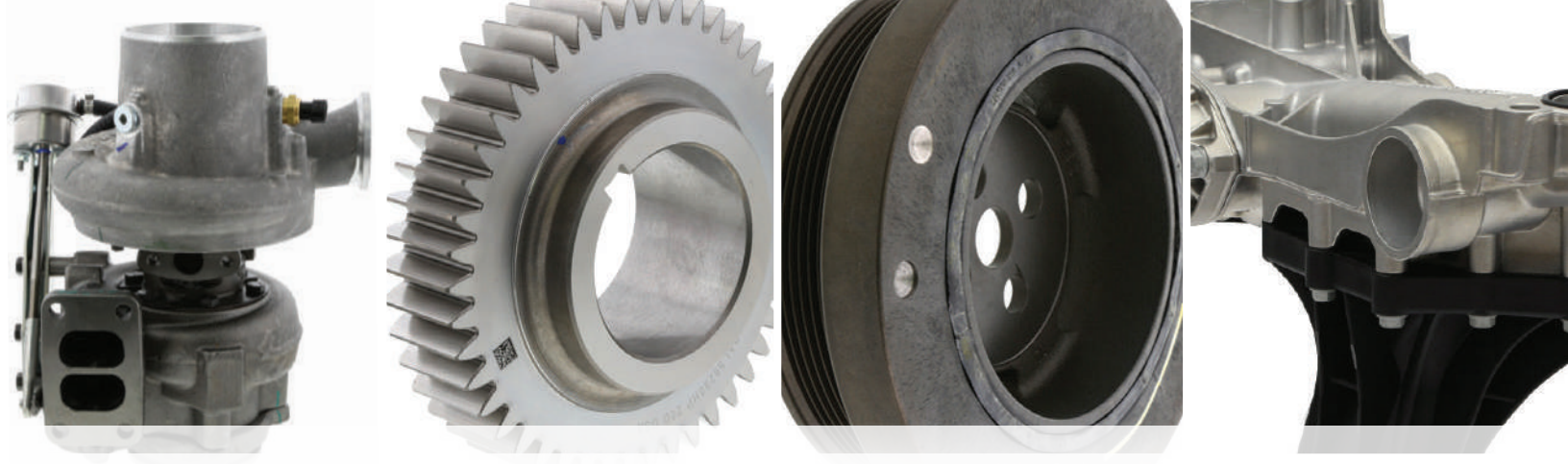

PAI MONTHLY NEWSLETTER - MAY 2020 EDITION

STAY CURRENT



World Tested. Performance Proven.

MAY 2020



STAY CURRENT

ISO:9001 CERTIFIED

Table of Contents

Price Reduced	2-3
Feature Item	4
High Performance Components	5
Cab & Chassis Components	6
Drive Train Components	7
Engine Components	8-10
New Available Engine Kits	11
Additional New Items	12



STAY CURRENT

WORLD TESTED. PERFORMANCE PROVEN.

Price Reduced

PAI Reference	OEM Reference	Description
FTK-3398	MAK 76MF527	Coolant Tank
LRV-3642	MAK 745-103028	Valve
MAC-4170	MAK 42QE2116P2	Hose
MAC-4171	MAK 42QE2116P1	Hose
MAC-4172	MAK 6635-73151612	Hose Set
FLS-4276	MAK 76MO37P2	Lamp Kit
FLM-4289	MAK 38MO362	Lamp
FBG-4464-BLU	MAK 10QK276	Bushing
FRM-4542	MAK 72QS418P2	Mirror
FAF-4561	MAK 57MD31A	Filter
GSC-6016	MAK 90KB111A	Screw
CCD-9764	MAK 101HB4136	Clutch Disc
CCD-9765	MAK 2104-128229	Clutch Disc
CCD-9775	MAK 2104-128230	Clutch Disc
EF59290HP	FUL 4300247	Countershaft Gear
EF61830HP	FUL 4300191	Countershaft Gear
EF62920HP	FUL 20482	Countershaft Gear
EF64150	FUL 4300466	Gear
EM48190	MAK 64AX106	Cup
EM67020	MAK 764KB3267A	Maindrive Gear
EM97640	MAK 101HB4136	Clutch Disc
EM97740	MAK 101HB4137	Clutch Disc
040116	N/A	Cylinder Head Bolt Kit
060163E	CUM 4962732	Cylinder Head Assembly
060175	CUM 4089290	Cylinder Head Assembly
131638E	CUM 4955596	Gasket Kit
171719	CUM 3064291	Crankshaft
181895	CUM 3023473	Accessory Drive Pulley
191882	CUM 3002901	Camshaft Gear
331138	N/A	Overhaul Gasket Kit
331224	CAT 7C8296	Isolator

PAI Reference	OEM Reference	Description
336066	CAT 8S7762	Water Pump Seal
341374	CAT 1154170	Oil Pan
360472	CAT 1481973	Flywheel Housing
381251	CAT 1352151	Belt Tensioner
390093X	CAT 2388091	Fuel Injector Assembly
441166	NAV 1840135C2	Support Rail
441167	NAV 1840136C1	Support Rail
441176	NAV 1836082C92	Oil Pan Kit
450650	NAV 1885812C91	Position Sensor
480009	NAV 1841820C1	Camshaft Gear Assembly
636028	DDC A4721880180	Seal
640015-019	N/A	Cylinder Head Bolt Kit
641281	DDC 23522283	Oil Pan Kit
641290	N/A	Oil Pan
641291	N/A	Oil Pan
641294	N/A	Oil Pan Kit
641295	N/A	Oil Pan Kit
642038	DDC 23537128	V-Band Clamp
661603-STD	DDC 23525500	Counterbore Repair Ring
661603-010	N/A	Counterbore Repair Ring
661603-020	N/A	Counterbore Repair Ring
661603-030	N/A	Counterbore Repair Ring
691840	DDC 23505899	Coolant Tube
803865	MAK 21026305	Surge Tank
807020	REY T-5493	Arm Bushing
808099	MAK 32KN312	Power Divider Cam
821071	MAK 1547253	Seal
880830	MAK 20997341	Fuel Pump
880830E	MAK 20997341	Fuel Pump
940180	ROK KIT5270	Synchronizer
ISB621-026HP	N/A	HP Engine Kit



STAY CURRENT

ISO:9001 CERTIFIED

Price Reduced

PAI Reference	OEM Reference	Description
ISX111-081HP	CUM 4352292	HP Engine Kit
ISX111-113HP	CUM 4352362	HP Engine Kit
466123-001	NAV 1893941C97	Engine Kit



STAY CURRENT

WORLD TESTED. PERFORMANCE PROVEN.

Featured Item of the Month

Caterpillar® Oil Pans

PAI offers a wide array of Heavy Duty Oil Pans that meets or exceeds OEM quality. Made on state-of-the-art high quality durable stamped steel and engineered for an exact fit.

Steel Oil Pan	PAI Reference	OEM Reference
	341374	CAT 1154170
	Pan Gasket #: Verify ESN	N/A
	Drain Plug #: 342153	CAT 1682288
	Description: Heavy Duty Oil Pan	
	Application: Caterpillar 3100 C7	
	Material : Steel	

Steel Oil Pan Kit	PAI Reference	OEM Reference
	341377	CAT 1228936
	Pan Gasket #: Verify ESN	N/A
	Drain Plug #: 342153	CAT 1682288
	Description: Heavy Duty Oil Pan	
	Application: Caterpillar 3100 C7	
	Material : Steel	
Kit Includes: Oil Pan (1)341374 Plug (1) ECP-3474 Plug (1)ECP-3475		

WARRANTY
TWO YEAR Unlimited Mileage





HIGH PERFORMANCE

WORLD TESTED. PERFORMANCE PROVEN.



OEM Reference	PAI Reference	Description
CUM 3979506	191893HP	Camshaft
Application: Cummins ISB		



OEM Reference	PAI Reference	Description
FUL 4300247	EF59290HP	Countershaft Gear
Application: Fuller RT 18918 / RT 16709 / RTA 16710C		



OEM Reference	PAI Reference	Description
FUL 4302695	EF59340HP	Mainshaft Splitter Gear
Application: Fuller RT 16710B		



OEM Reference	PAI Reference	Description
FUL 4300940	900062HP	Auxiliary Mainshaft Gear
Application: Fuller RTLO 12713, 14713, 16713, 18913A		



STAY CURRENT

WORLD TESTED. PERFORMANCE PROVEN.



OEM Reference	PAI Reference	Description
NAV 2018471C1	481121	Muffler(36.25in OAL) (8.2in x 11.5in Oval) (3.5in Inlet Tube)(4in Outlet Tube)
Application: International 1000 / 2000 /3000		

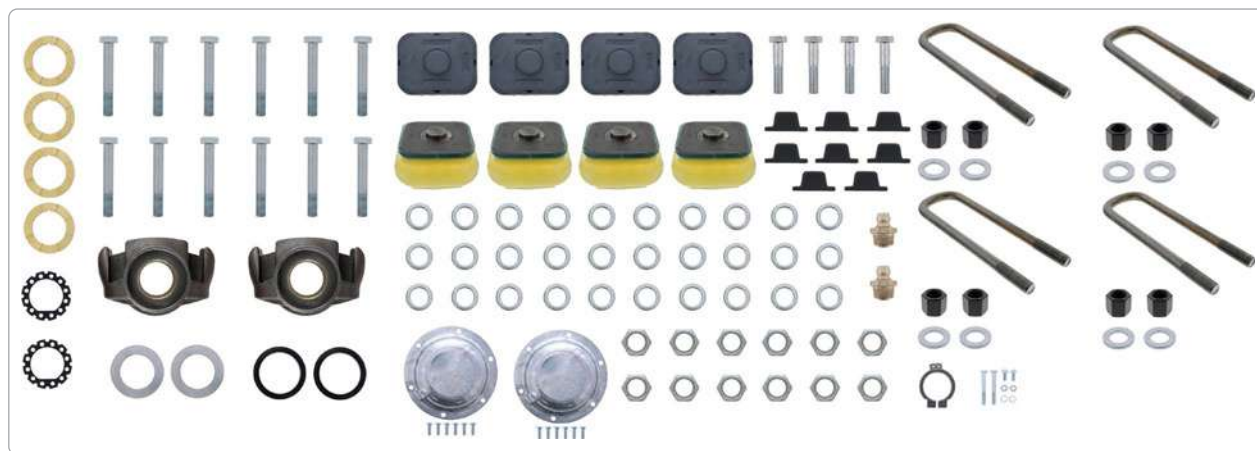

OEM Reference	PAI Reference	Description
N/A	836070	Trunion Rebuild Kit Includes Trunnions (2)EM47550 Trunion Rebuild Kit (1)FKT-5153 Insulators (4)FSI-2000 (4)EM49100 Washers (30)FWA-0058 Trunion Cap Kit (2)808085 Nuts (12)FNU-0199 Screws (12)FSC-4680 (4)FSC-0117 Spacers (8)EM47520 U-Bolt Kits (4)FUB-4765C Fittings (2)FGF-0173
Application: Mack 44,000 Lb Camel Back		

Air & Electrical

Cab & Chassis

Drivetrain

Engine

Sensors



STAY CURRENT

ISO:9001 CERTIFIED



OEM Reference	PAI Reference	Description
EAT 125596	920015	Clutch Release Yoke
Application: Eaton Multiple		



OEM Reference	PAI Reference	Description
DAN 6-4-6421-1X	960048	Half Round End Yoke (w/ Dust Shield)
Application: Dana 1700 / 1710		

Air & Electrical

Cab & Chassis

Drivetrain

Engine

Sensors



STAY CURRENT

WORLD TESTED. PERFORMANCE PROVEN.



OEM Reference	PAI Reference	Description
CUM 3074250PX	209959X	Reman Fuel Injector Assembly
Application: Cummins L10		



OEM Reference	PAI Reference	Description
CUM 3054232	209971X	Reman Fuel Injector Assembly
Application: Cummins 855		



OEM Reference	PAI Reference	Description
CUM 4955833	181179	Turbocharger(Waste Gated)
Application: Cummins 6C 8.3 Liter		



OEM Reference	PAI Reference	Description
CUM 3922559	202023	Crankshaft Damper(8 Grooves)
Application: Cummins 6C / ISC / ISL		

Air & Electrical

Cab & Chassis

Drivetrain

Engine

Sensors



STAY CURRENT

ISO:9001 CERTIFIED

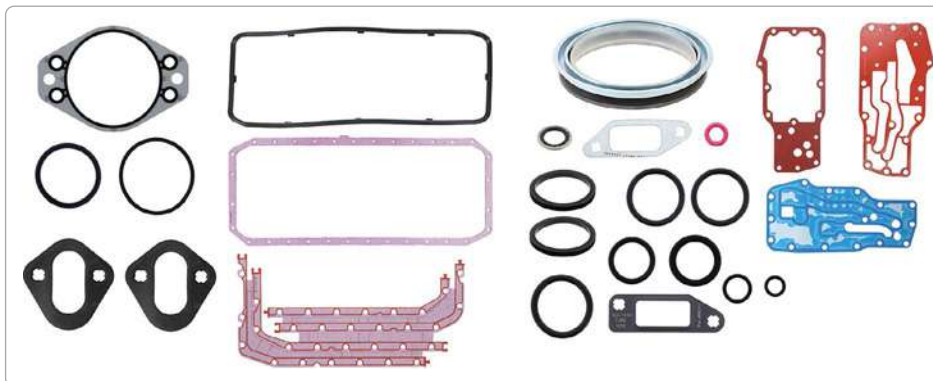

OEM Reference	PAI Reference	Description
CUM 4376091	132045	Lower Gasket Kit Includes Pan Gaskets (1)131794 (1)132020 (1)132044 Rear Seal (1)136026 Block Kit (1)132045-170 Gasket Kit (1)132045-171 Oil Cooler Kit (1)132045-173 Fuel Gasket Kit (1)132045-174
Application: Cummins ISB / QSB		



OEM Reference	PAI Reference	Description
N/A	040116	Cylinder Head Bolt Kit Includes Bolts (22)040136 (12)040137
Application: Cummins ISX		

Air & Electrical

Cab & Chassis

Drivetrain

Engine

Sensors



STAY CURRENT

WORLD TESTED. PERFORMANCE PROVEN.



OEM Reference	PAI Reference	Description
DDC A4721800351	641306	Oil Pump Pickup Tube Assembly
Application: Detroit Diesel Series DD15		

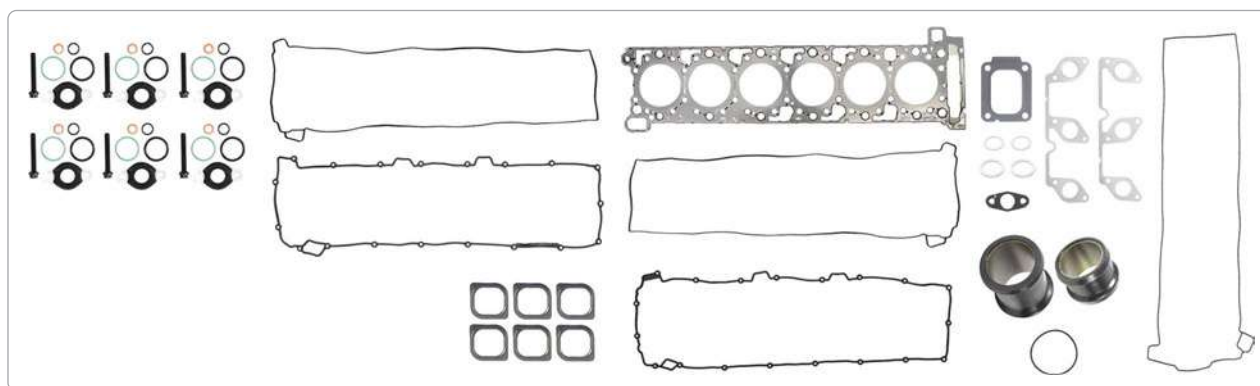

OEM Reference	PAI Reference	Description
N/A	631401	Cylinder Head Gasket Kit Head Set (1)631354 Intake Gasket Kit (1)631400-151 Turbo Gasket Kit (1)631400-152 Valve Cover Kit (1)631398 Valve Cover Kit (1)631399
Application: Detroit Diesel Series DD15		



OEM Reference	PAI Reference	Description
MAK 736GB415M	891960	Fuel Injector
Application: Mack E-Tech		

Air & Electrical

Cab & Chassis

Drivetrain

Engine

Sensors



STAY CURRENT

ISO:9001 CERTIFIED

New Engine Kits Available

OEM Reference	PAI Reference	Application
N/A	N14222-017HP	Cummins N14
N/A	ISC105-001	Cummins ISC
N/A	ISX105-161	Cummins ISX
VOL 85110455	D12101-001	Volvo D12



STAY CURRENT

WORLD TESTED. PERFORMANCE PROVEN.

Additional New Items

PAI Reference	OEM Reference	Description
040158	CUM 3686937	Screw
040159	CUM 3678882	Bolt
040160	CUM 3680817	Bolt
101126	N/A	Cylinder Kit
101182HP	N/A	Cylinder Kit
111121HP	CUM 3052794	HP Piston
111770	N/A	Piston Kit
342153	CAT 1682288	Drain Plug
671565AHP	DDC A4720300960	Rod Bearing
805058	VOL 20747511	Piston Ring Set
805068	VOL 20707511	Piston Ring Set
840039	MAK 984736	Screw
900617	FUL 4301855	Bearing

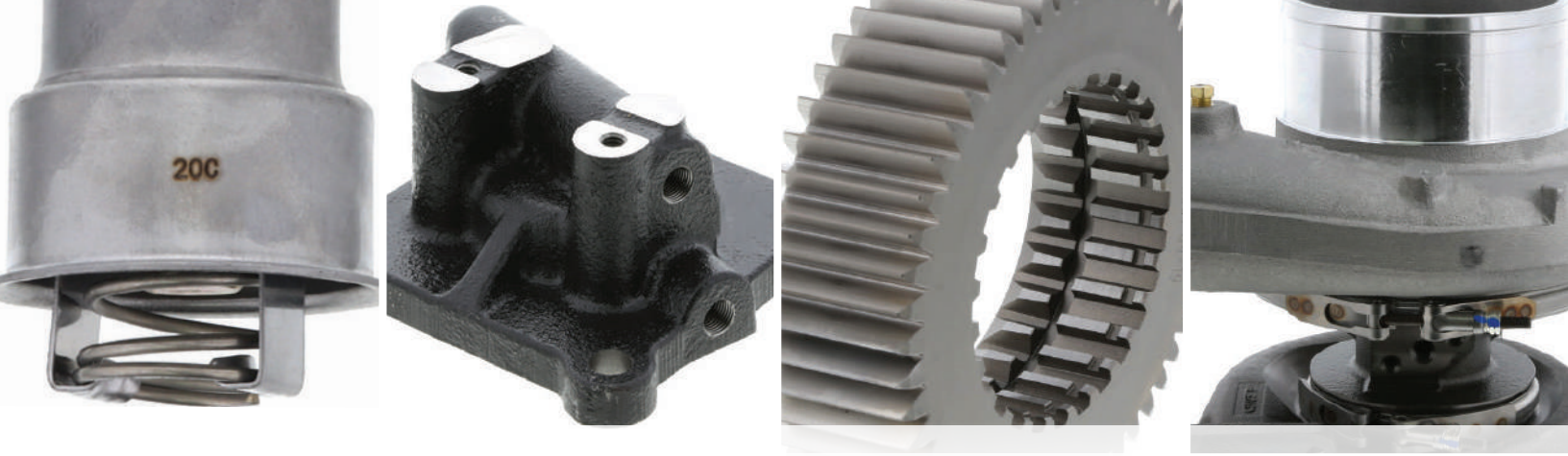

PAI MONTHLY NEWSLETTER - JUNE 2020 EDITION

STAY CURRENT



World Tested. Performance Proven.

JUNE 2020



STAY CURRENT

ISO:9001 CERTIFIED

Table of Contents

Price Reduced	2
Feature Item	3
Oil Pump Testing	4-5
Drive Train Components	6
Engine Components	7-10
New Available Engine Kits	11
Additional New Items	12



STAY CURRENT

WORLD TESTED. PERFORMANCE PROVEN.

Price Reduced

PAI Reference	OEM Reference	Description
EOP-2045	MAK 240GB5263M6	Oil Pan
GBK-6561	MAK 208SH106	Bearing Kit
ECM-8791	MAK 454GC5235	Camshaft
ECK-9148	MAK 57GC2210A	Camshaft Kit
340062	CAT 9X6620	Nut
410114	NAV 1891377C1	Piston
410115	N/A	Piston Kit
440005	NAV 1824955C2	Cylinder Head Bolt
490018	NAV 1894238C92	Camshaft Kit
640045	DDC A4720140583	Screw Assembly
641292	DDC A4720102313	Oil Pan Kit
660010	DDC 23522272	Valve Cover
681230	DDC 23523975	Accessory Drive Pulley
730432	PBT N5346001	Coolant Tank
803863	N/A	Surge Tank Kit
803865	MAK 21026305	Surge Tank
803882	MAK 32QM4231	Cab Step Plate
803922	MAK 3QM314M	Latch Catch
803923	MAK 3QM315M	Latch Catch
803966	MAK 20QL352M	Radiator Isolator
804072	MAK 222GB46M	Oil Cap
804291	MAK 25QK43M	Wear Pad
821081	MAK 984797	O-Ring
831006	MAK 8192189	Sealing Ring
831116	MAK 11ME399	Turbo Gasket
841202	MAK 240GB5263M5	Oil Pan
841203	MAK 240GB5263M7	Oil Pan
900015	FUL 4304635	Gear
900192	FUL A-6436	Countershaft Assembly
940150	ROK B-41512-1	Gear Set
940151	ROK B-41680-1	Gear Set

PAI Reference	OEM Reference	Description
940152E	ROK B-41678-1	Gear Set
940154	ROK B-41684-1	Gear Set
940155E	ROK B-41686-1	Gear Set
940162	ROK B-41532-1	Gear Set
940165	ROK B-41548-1	Gear Set



STAY CURRENT

ISO:9001 CERTIFIED

Featured Item: Mack Surge Tanks w/ Radiator Caps

PAI's Surge Tanks - Manufactured utilizing High-Grade material to withstand the stresses of underhood heat and engine vibration. They are thoroughly tested to ensure optimum fit and performance on specific vehicle applications.



PAI Ref.	OEM Ref.	Description
FTK-3398	MAK 76MF527	Surge Tank Kit (Aluminum) Kit Includes Pressure Cap (ERC-8319) Fitting (840066) Glass Site Connector (803867)
Application: Mack CXP, CXN, CX, CTP, CT and CV Models		

803863	N/A	Surge Tank Kit (Retro Fit)
Kit Includes: Coolant Tank (1)FTK-3398 Tank Strap (1)842015 Cap (1)ERC-8382 Insulators (2)803877-001 Washers (2)841251 Nut(1)840138 Mounting Bracket (1)803876 Cable Ties (1)831119 (10)831118 Plug (1)FPP-3577 Fittings (1)840095 (1)840109 Hose (1)840144-005		



PAI Ref.	OEM Ref.	Description
803865	MAK 21026305	Surge Tank Kit (Aluminum) Kit Includes Pressure Cap (ERC-8319) Fitting (840066) Glass Site Connector (803867)
Application: Mack CHN and CH Models		

803864	N/A	Surge Tank Kit (Retro Fit)
Kit Includes: Coolant Tank (1)803865 Tank Strap (1)842015 Insulators (2)803877-001 Washers (2)841251 Nut(1)840138 Mounting Bracket (1)803876 Cable Ties (1)831119 (10)831118 Plug (1)FPP-3577 Fittings (1)840095 (1)840109 Hose (1)840144-005		

- Replaces Plastic Tanks:**
PAI#: FTK-3421 OEM#: 76MF520M
PAI#: FTK-3422 OEM#: 76MF516M
- Redesigned to Prevent Leaks and Cracking**
- Ensures Optimum Fit and Performance**
- OEM Recommended Specs**
- High-Grade Material**
- 2-Year Warranty**

TWO YEAR WARRANTY Unlimited Mileage



PRECISION. ACHIEVEMENT. INNOVATION.



OIL PUMP TESTING SYSTEM

At PAI Industries quality and performance are the key elements considered to maintain customer satisfaction. The success of our new designs, products, and services is established from strict, but absolute testing. We recently redesigned our Oil Pump Test System (OPTS) and it has already proven to be an advantage in our production.

The redesigned OPTS exceeds our previous system with reinforced methods to determine the accuracy of various evaluations. It was custom built by PAI's own technicians with added features for quality assurance. Our initial OPTS only monitored RPM, pressure, and oil flow. The new system has the addition of temperature monitoring, which is based on actual parameters as if the oil pumps were installed on truck engines. We've also upgraded to digital gages. Now our readings are unquestionable, and the results can be recalled with pass, or fail diag-

nostics. More importantly, the redesigned OPTS is driven by Programmable Logic Control (PLC), which maintains a history database for each oil pump. This design gives PAI the ability to store data for future knowledge; it is readily available and printable upon our customer's request.



Oil Pump Testing System Control Panel

PRECISION. ACHIEVEMENT. INNOVATION.

DRIVING PURPOSE FOR THE NEW OIL PUMP TEST SYSTEM

We expect that our OPTS' new standardized adjustments, as well as its automation aspect will put us in position to educate our customers on the quality and expertise of our product. With the new system in place, PAI is already simulating and tracking extreme measures of operation for the Detroit Series 60 12.7 Liter, the Detroit 14L, the Detroit DD15, and the Cummins 1150-C. Our goal is to implement all our existing oil pumps into this new system, because we can now capture and store pertinent warranty-based information. For immediate identification, each oil pump has its own code and serial number, which is used for data recall. We continually seek practical challenges to get factual results. Printable upon our customer's request.

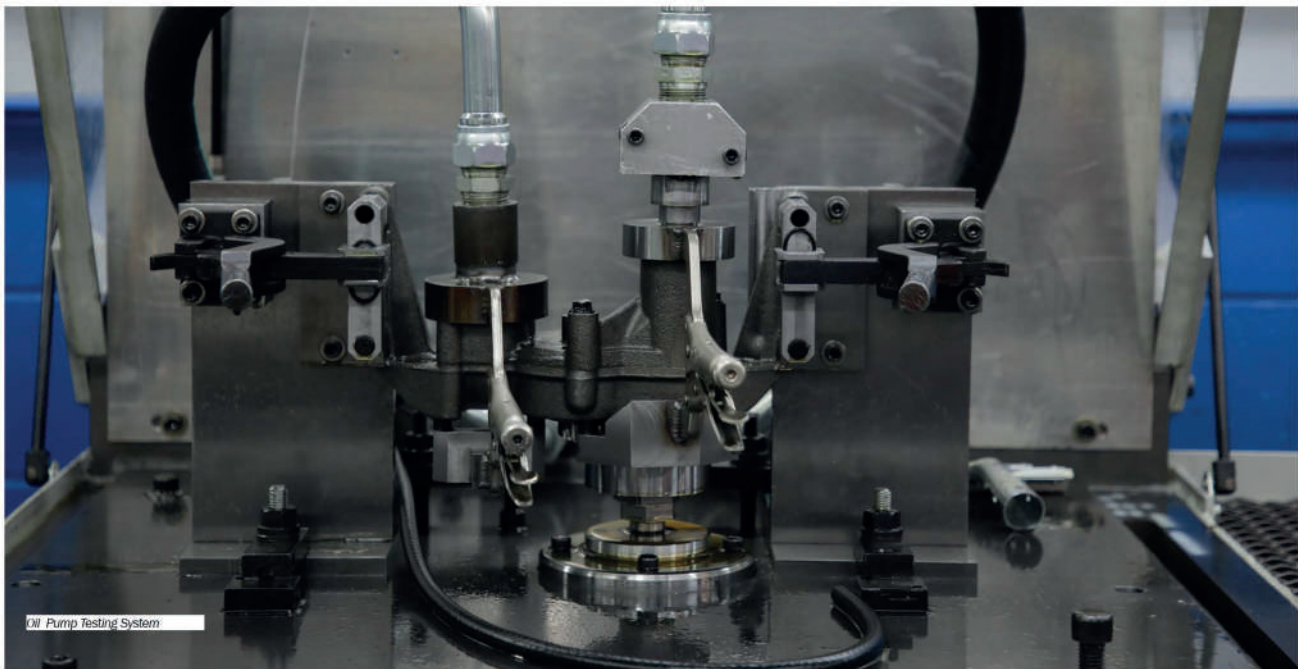

PRECISION | RELIABILITY | QUALITY ASSURANCE

Flow and Pressure Curves - Temperature Control - Programmable Logic Control - Simplified Pass/Fail Determination



STAY CURRENT

WORLD TESTED. PERFORMANCE PROVEN.



OEM Reference	PAI Reference	Description
DAN 104461-1	960340	Clutch Assembly(Single Plate) (430mm x 50mm x 46mm Spline)
Application: Dana / Eaton Multiple		

Air & Electrical
Cab & Chassis
Drivetrain
Engine
Sensors



OEM Reference	PAI Reference	Description
FUL 4303926	900414	Range Cylinder Cover
Application: Fuller Multiple		



OEM Reference	PAI Reference	Description
FUL 4304641	900022HP	Main Drive Gear (52 Outer Teeth)(26 Inner Teeth)
Application: Fuller Multiple		



STAY CURRENT

ISO:9001 CERTIFIED



OEM Reference	PAI Reference	Description
ROK KIT-5401	940289	Range Kit Includes: Piston (1)940190 Nut (1)940211 Seal (1)940291 Lubricant (1)940283 O-Rings (2)EGA-3174 (2)121254 (1)321421
Application: Rockwell 9 & 10 Speed Transmissions		



OEM Reference	PAI Reference	Description
ROK 1244M2041	940048	Main Case Spacer
Application: Rockwell 9 & 10 Speed Transmissions		

Air & Electrical
Cab & Chassis
Drivetrain
Engine
Sensors



STAY CURRENT

WORLD TESTED. PERFORMANCE PROVEN.



OEM Reference	PAI Reference	Description
SCH 14969880000	381198	Turbocharger
Application: Caterpillar 1999-2009 C15 ASERT / C16		

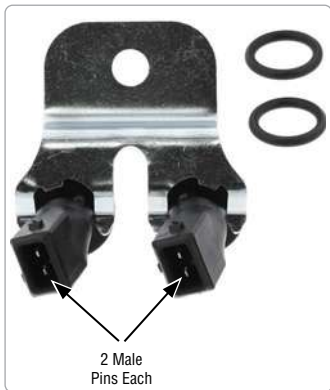

OEM Reference	PAI Reference	Description
CAT 2366221	350629	Speed Sensor Kit Includes Sensor (1)350630 O-Rings (2)321375
Application: Caterpillar Multiple		



Front View



Rear View

OEM Reference	PAI Reference	Description
CAT 1482144	360440E	Cylinder Head Assembly
Application: Caterpillar C12		



OEM Reference	PAI Reference	Description
CUM 4952631	181960	Thermostat(215 F Degrees)
Application: Cummins 855 / N14		

Air & Electrical

Cab & Chassis

Drivetrain

Engine

Sensors



STAY CURRENT

ISO:9001 CERTIFIED

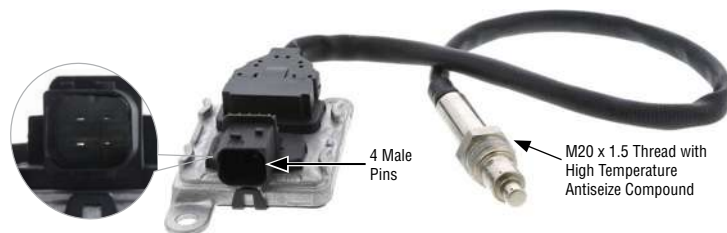

OEM Reference	PAI Reference	Description
DDC A0101532228	650620	NOX Sensor(17.25in Lead Length)
Application: Detroit Diesel DD15		

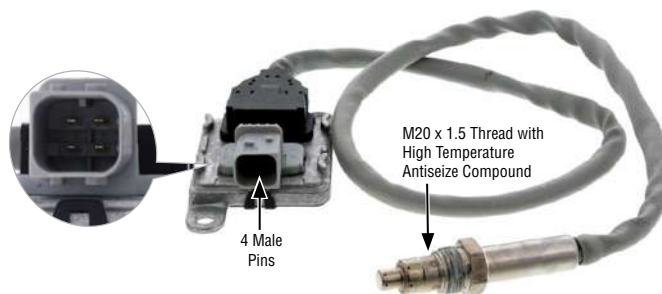

OEM Reference	PAI Reference	Description
DDC A0101532328	650621	NOX Sensor(29in Lead Length)
Application: Detroit Diesel DD15		



Front View



Rear View

OEM Reference	PAI Reference	Description
DDC 23525566	660005E	Cylinder Head Assembly
Application: Detroit Diesel Series 60		

Air & Electrical

Cab & Chassis

Drivetrain

Engine

Sensors



STAY CURRENT

WORLD TESTED. PERFORMANCE PROVEN.



OEM Reference	PAI Reference	Description
N/A	692083	Fuel Injector Tube Kit Includes: Sleeve (1)692088 O-Ring (1)321292

Application: Detroit Diesel Series 60



OEM Reference	PAI Reference	Description
NAV 1845004C92	481136	Exhaust Manifold Kit Includes: Manifolds (1)481127 (1)481128 (1)481129 Studs (2)440115

Application: International DT570 /DT466E HEUI



OEM Reference	PAI Reference	Description
MAK 20486222	891970	Crankshaft

Application: Mack MP8 / Volvo D13



STAY CURRENT

ISO:9001 CERTIFIED

New Engine Kits Available

OEM Reference	PAI Reference	Application
N/A	ISL201-026	Cummins ISL
N/A	ISM102-017HP	Cummins ISM
VOL 85124806	D13103-037	Volvo D13



STAY CURRENT

WORLD TESTED. PERFORMANCE PROVEN.

Additional New Items

PAI Reference	OEM Reference	Description
ENU-0451	MAK 20705943	Nut
101028HP	CUM 3801823	Cylinder Kit
111623HP	CUM 4938620	Piston
111752	CUM 4089725	Piston Kit
111765	CUM 4376246	Piston / Ring Kit
111767	N/A	Piston Kit
132053	CUM 3971163	Gasket
132060	CUM 3347832	Grommet
311077	CAT 7N9803	Piston Pin
331700	CAT 9N1832	Gasket
505099HP	CUM 4089385	HP Piston Ring Set
505134E	CUM 4089181	Piston Ring Set
861617	N/A	Liner Kit



PAI MONTHLY NEWSLETTER - OCTOBER 2019 EDITION

STAY CURRENT



World Tested. Performance Proven.

OCTOBER 2019



STAY CURRENT

ISO 9001 CERTIFIED

OCTOBER 2019

TABLE OF CONTENTS

Price Reduced	2
Feature Item	3
Sensors & Components	4
Drive Train Components	5-7
Engine Components	8-10
Additional New Engine Kits	11
Additional New Items	12



STAY CURRENT

WORLD TESTED. PERFORMANCE PROVEN.

OCTOBER 2019

PRICE REDUCED

PAI REFERENCE	OEM REFERENCE	DESCRIPTION
EFI-2563	MAK 203GC4245	Tube
EAS-8766	MAK 453GC431AM	Aux. Shaft Assembly
CCD-9771	MAK 101HB462P2	Disc Assembly
EM62520	MAK 751KB3450A	Gear
050771	CUM 3687930	NOX Sensor
171821	CUM 3945917	Bearing Kit
181021	N/A	Exhaust Manifold Kit
180123	N/A	Exhaust Manifold Kit
301046HP	N/A	Cylinder Kit
370015	CAT 9Y7735	Rod Bearing
370015HP	CAT 9Y7735	Rod Bearing
480254X	NAV 1848489C92	Fuel Injector Assembly
480263X	NAV 1890055C92	Fuel Injector Assembly
609890X	DDC 414703003	Injector Assembly
636020	DDC 23516969	Seal Kit
671672	DDC 8929497	Timing Gear
741421E	FTL A68146601K1	Power Steering Pump
750151	HDK 60262-000	Main Support
803973	MAK 20QL344M3	Engine Mount
806782	MAK 20771311	Gear Assembly
C70102-118	N/A	Engine Kit
S60115-017	N/A	Engine Kit
S60116-017	N/A	Engine Kit
S60116-033	N/A	Engine Kit
S60116-081	N/A	Engine Kit
S60117-017	DDC 23538418	Engine Kit
MP8140-015	N/A	Engine Kit



PAI Aluminum Caterpillar Oil Pan

World Tested . Performance Proven. - ISO 9001 : CERTIFIED

OCTOBER 2019

FEATURED ITEM OF THE MONTH

Caterpillar Oil Pan

PAI now offers an All New Aluminum Oil Pan that meets or exceeds OEM quality. Made on state-of-the-art High Pressure Die Casting technology, these pans offer the following key benefits.



Stronger, Lighter Oil Pan
Even Wall Thickness
Superior Finish
High Pressure Die Casting for Longer Life
High Precision CNC Machining
Drain Plugs Are Included

Caterpillar Oil Pan 3406 Series		
PAI Ref.	OEM Ref.	Description
341370	CAT7C3236	Oil Pan (3406B, 3406C, 3406E)

TWO YEAR WARRANTY Unlimited Mileage 





STAY CURRENT

WORLD TESTED. PERFORMANCE PROVEN.

OCTOBER 2019

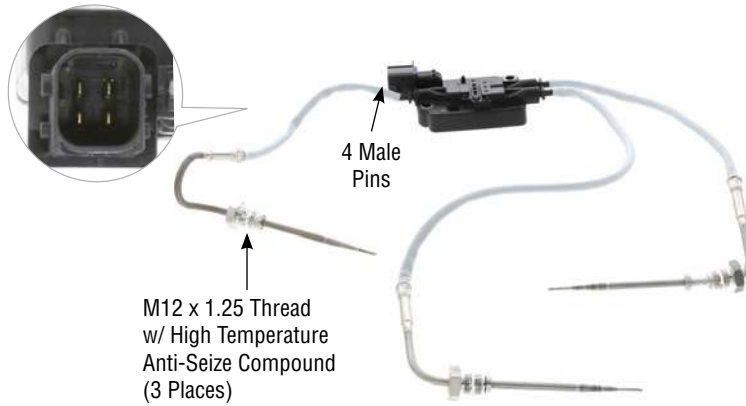

OEM REFERENCE	PAI REFERENCE	DESCRIPTION
CUM 4384812	050727	NOX Sensor(35in Cord Length)
Application: Cummins ISX / QSX Engines		

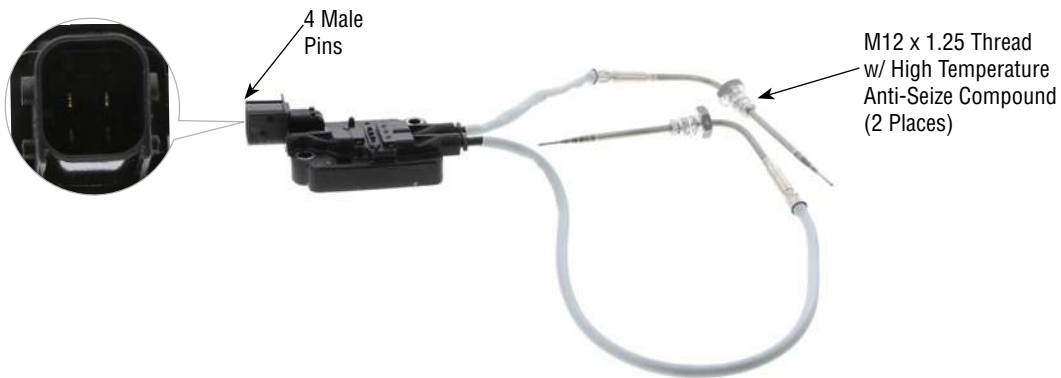

OEM REFERENCE	PAI REFERENCE	DESCRIPTION
CUM 4384811	050728	Exhaust Temperature Sensor(Dual Probe)(12V)
Application: Cummins ISX Engines		

AIR & ELECTRICAL

CAB & CHASSIS

DRIVE TRAIN

ENGINE

SENSORS



STAY CURRENT

ISO 9001 CERTIFIED

OCTOBER 2019



OEM REFERENCE	PAI REFERENCE	DESCRIPTION
EAT 504404-1	920053	Input / Differential Kit(Minor) Includes Differential Assembly (1)EE21040 Side Gear (1)EE96240 Drive Gear (1)EE96210

Application: Eaton DS / DA / DD 344, 404, 405 & 454 Differentials



OEM REFERENCE	PAI REFERENCE	DESCRIPTION
EAT 504404-5	920054	Input / Differential Kit(Minor) Includes Differential Assembly (1)EE21040 Side Gear (1)EE96240 Drive Gear (1)EE96210

Application: Eaton DS / DA / DD 344, 404, 405 & 454 Differentials (After June 2008)



OEM REFERENCE	PAI REFERENCE	DESCRIPTION
EAT 504461-1	920059	Input / Differential Kit(Minor) Includes Differential Assembly (1)EE20830 Side Gear (1)EE96070 Drive Gear (1)EE95930

Application: Eaton DD / DS 461, 521, 581, 601 Differentials

AIR & ELECTRICAL

CAB & CHASSIS

DRIVE TRAIN

ENGINE

SENSOR



STAY CURRENT

WORLD TESTED. PERFORMANCE PROVEN.

OCTOBER 2019



900392



900393

OEM REFERENCE	PAI REFERENCE	DESCRIPTION	APPLICATION
FUL 18928	900392	Yoke Bar	Fuller Multiple Transmissions
FUL 4303596	900393	Yoke Bar	



900336 Shown

OEM REFERENCE	PAI REFERENCE	DESCRIPTION	APPLICATION
FUL 4301168	900336	Shift Lever	Eaton / Fuller Multiple Transmissions
FUL 21235	900337	Shift Lever	



OEM REFERENCE	PAI REFERENCE	DESCRIPTION
FUL K-3480	900167HP	Auxiliary Drive Gear Kit Includes HP Main Drive Gear (1)EF59310HP Retaining Ring (1)900208 Washer (1)EF10290 Spacer (1)900136

Application: Multiple Fuller Transmissions

AIR & ELECTRICAL

CAB & CHASSIS

DRIVE TRAIN

ENGINE

SENSOR



STAY CURRENT

ISO 9001 CERTIFIED

OCTOBER 2019



OEM REFERENCE	PAI REFERENCE	DESCRIPTION
FUL 4303497	900699	Mainshaft Gear(1st)
Application: Fuller Multiple Transmissions		



OEM REFERENCE	PAI REFERENCE	DESCRIPTION
FUL 4301847	900407	Range Cylinder
Application: Eaton / Fuller Multiple Transmissions		



OEM REFERENCE	PAI REFERENCE	DESCRIPTION
MAK 615KC4209	806765	Front Mainshaft(31 Teeth)(38 Teeth)
Application: Mack T309, T310, T2090, T2100 Transmissions		



OEM REFERENCE	PAI REFERENCE	DESCRIPTION
VOL 20532220	806812	Synchronizer Hub(2nd)
Application: Volvo I-Shift Transmissions		

AIR & ELECTRICAL
CAB & CHASSIS
DRIVE TRAIN
ENGINE
SENSOR



STAY CURRENT

WORLD TESTED. PERFORMANCE PROVEN.

OCTOBER 2019

AIR & ELECTRICAL

CAB & CHASSIS

DRIVE TRAIN

ENGINE

SENSOR



OEM REFERENCE	PAI REFERENCE	DESCRIPTION
CUM 3934486	136026R	Rear Crankshaft Seal Includes Seal (1)136158 Sleeve (1)136175 Driver (1)136177
Application: Cummins Multiple Engines		



OEM REFERENCE	PAI REFERENCE	DESCRIPTION
CUM 3802908	181181	Turbocharger(Non-Wastegated)
Application: Cummins 4B Engines		



OEM REFERENCE	PAI REFERENCE	DESCRIPTION
CUM 4952780	141286E	Oil Pan(Stamp Steel Rear Sump)
Application: Cummins ISM / M11 Engines		



STAY CURRENT

ISO 9001 CERTIFIED

OCTOBER 2019



OEM REFERENCE	PAI REFERENCE	DESCRIPTION
CUM 4952785	141285E	Oil Pan(Stamp Steel Front Sump)
Application: Cummins ISM / M11 Engines		



OEM REFERENCE	PAI REFERENCE	DESCRIPTION
CUM 4955707	181952	Water Pump Kit(Short Shaft) Includes Pump (1)181953 Gasket (1)131565 O-Rings (1)121305 (1)121277 (2)121304
Application: Cummins ISM Engines		



042044 SHOWN

OEM REFERENCE	PAI REFERENCE	DESCRIPTION
CUM 3684417	042044	V-Band Clamp(3-7/8in Dia. w/ Lock Nut)
CUM 4966454	042047	V-Band Clamp(4-5/16in Dia. w/ Lock Nut)
CUM 2880213	042048	V-Band Clamp(6-5/16in Dia. w/ Lock Nut)

AIR & ELECTRICAL

CAB & CHASSIS

DRIVE TRAIN

ENGINE

SENSOR



STAY CURRENT

WORLD TESTED. PERFORMANCE PROVEN.

OCTOBER 2019

AIR & ELECTRICAL

CAB & CHASSIS

DRIVE TRAIN

ENGINE

SENSOR



OEM REFERENCE	PAI REFERENCE	DESCRIPTION
DDC 23533221	681134	EGR Pipe
Application: Detroit Diesel 60 Series Engines		



OEM REFERENCE	PAI REFERENCE	DESCRIPTION
NAV 1807974C94	481827	Thermostat(190°)(Non-Vented) (Gasket Included)
Application: International 7.3 / 444 Engines		



OEM REFERENCE	PAI REFERENCE	DESCRIPTION
MAK 454GC5142A	ECM-9007E	Camshaft
Application: Mack E7 Engines		



OEM REFERENCE	PAI REFERENCE	DESCRIPTION
MAK 21141725	801115	Idler Pulley(10 Groove)
Application: Mack MP7 & MP8 Volvo D11 & D13 Engines		



STAY CURRENT

ISO 9001 CERTIFIED

OCTOBER 2019

NEW AVAILABLE ENGINE KITS

OEM REFERENCE	PAI REFERENCE	APPLICATION
N/A	ISB606-107HP	Cummins ISB Engines
CUM 4376179	ISX108-097	Cummins ISX Engines
CUM 4352294	ISX108-113	
CUM 4352362	ISX111-113HP	
CUM 4376175	ISX113-017	



STAY CURRENT

WORLD TESTED. PERFORMANCE PROVEN.

OCTOBER 2019

ADDITIONAL NEW ITEMS

PAI REFERENCE	OEM REFERENCE	DESCRIPTION
040114	CUM 4965484	Spacer
042148	CUM 3955114	Isolator
045075	CUM 3056508	Drive Pin
111137HP	N/A	Piston Kit
111554HP	N/A	Piston Kit
111779	N/A	Piston Kit
141345	CUM 4938655	Pan Adapter
161655	CUM 4376168	Liner Kit
171955HP	CUM 3967060	Bearing Kit
321488	CAT 1188586	O-Ring
321489	CAT 8M5661	O-Ring
470102HP	NAV 1822487C91	Rod Bearing
470112HP	NAV 1822491C91	Main Bearing
470117HP	NAV 1822495C91	Main Bearing
803876	MAK 72RU11627	Bracket Mount
805046	VOL 20736734	Ring Set
871066	VOL 276630	Cam Bearing
871067	VOL 20503200	Cam Thrust Bearing

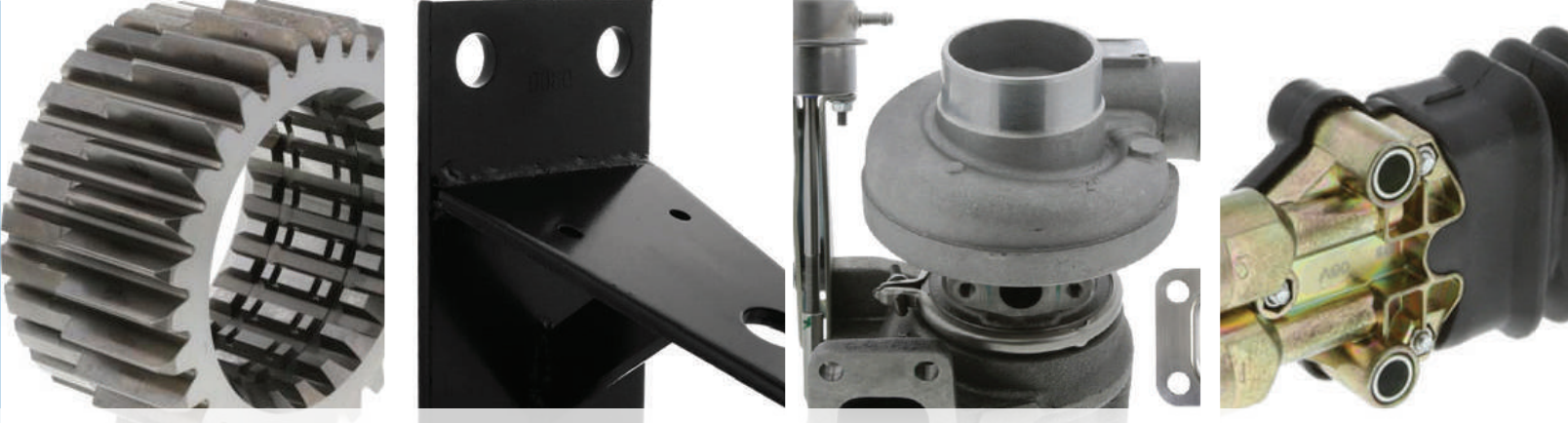

PAI MONTHLY NEWSLETTER - NOVEMBER 2019 EDITION

STAY CURRENT



World Tested. Performance Proven.

NOVEMBER 2019



STAY CURRENT

ISO 9001 CERTIFIED

NOVEMBER 2019

TABLE OF CONTENTS

Price Reduced	2-4
Sensors & Components	5
Cab & Chassis Components	6-7
Drive Train Components	8
Engine Components	9-11
Additional New Items	12



STAY CURRENT

WORLD TESTED. PERFORMANCE PROVEN.

NOVEMBER 2019

PRICE REDUCED

PAI REFERENCE	OEM REFERENCE	DESCRIPTION
FAS-0579	GDY 1R13-130	Air Spring
FAS-0757	GDY 1R13-153	Air Spring
RMT-0953	MAK 2790-HV33109	Motor Mount
DCH-1106	MAK 745-282089	Cylinder Head Assy.
EET-1846	MAK 5839-89047C	Exhaust Pipe
EET-1898	MAK 4ME32825	Exhaust Pipe
HSB-2430-001	N/A	Brake
BWA-3092	MAK 297KB123B	Clamp
HBD-3259	MAK 9872-88870BK	Brake Drum
HPB-3030-200	MAK 6152-3030PB	Piggy Back
ESP-3945	MAK 38QC220AP1	Pressure Relief Pump
FHC-4006	MAK 31QC39304AP2	Cylinder
FSF-4238	MAK 47M019301	Flasher
FFF-4536	MAK 483GB465	Filter
FTB-4984	MAK 39QK325	Trunnion Assembly
FHL-5298A	MAK 2M0520M	Lamp Assembly
FHL-5299A	MAK 2M0521M	Lamp Assembly
MRT-5357	LNV 79192	Rotor
FBL-5467	MAK 3115-3131877	Blade Assembly
FFF-5486	MAK 483GB476M	Filter
BSH-5509	MAK 8235-3202L6564	Axle
BSH-5552	MAK 2719-38208	Axle
BSH-5582	MAK 2719-110881	Axle
BSH-5607	MAK 4333-571351C2	Axle
HSS-5751	MAK 18AX1156	Stud
GGB-5945	MAK 751KB3382A	Gear
BSH-6759	MAK 68KH3225P2	Axle
BSH-6765	MAK 4103-5001831169	Axle
JUJ-6775	MAK 2104-5297X	U-Joint
BDS-6809	MAK 2104-231102	Dust Shield
BOS-7615	MAK 88AX427	Seal

PAI REFERENCE	OEM REFERENCE	DESCRIPTION
EFN-8616	MAK 2MH414P56	Fan
EIN-8937	MAK 114GC324AP4	Nozzle
BRP-9029	EAT 211483	Gear Set
AKP-9220	MAK 301SQ46B	King Pin Kit
ANU-9319	MAK 22QH128	Nut
BRP-9351	EAT 98118	Gear Set
AKP-9820	MAK 301SQ31C	King Pin Kit
HSS-9874	MAK 8148-18703731	Shaft
THC-9919	N/A	Trailer Hubcap
AKT-9998	MAK 8226-L32KE5	Socket Kit
EE92360	EAT 95587	Gear Set
EE07840	EAT 126002	Spider
EE20730	EAT 114469	Nest Kit
EE22340	EAT 95204	Nut
EE23040	EAT 104456	Shaft Kit
EE71050	EAT 118109	Overhaul Kit
EE78230	EAT 113598	Gear
EE90570	EAT 122396	Gear Set
EE93440	EAT 98116	Gear Set
EE94020	EAT 95559	Gear Set
EE94160	EAT 96839	Gear Set
EE95890	EAT 126000	Gear
EF60090	FUL 16310	Washer
EF61520	FUL K-1799	Small Parts Kit
EF62170	FUL 16002	Gear
EF63270	FUL 16887	Gear
EF64080	FUL 17569	Gear
EF64490	FUL K-2228	Mainshaft Kit
EF65370	FUL K-1999	Overhaul Kit
EF65450	FUL K-2335	Bearing Kit
EF65480	FUL K-2338	Bearing Kit



STAY CURRENT

ISO 9001 CERTIFIED

NOVEMBER 2019

PRICE REDUCED

PAI REFERENCE	OEM REFERENCE	DESCRIPTION
EF66160	FUL K-1853	Bearing Kit
EF66390	FUL 21499	Gear
EF68180	FUL K-2988	Mainshaft Kit
EF89850	FUL K-3257	Bearing & Seal Kit
EF89890	FUL K-3322	Bearing & Seal Kit
EM24300-001	N/A	Spring Brake
EM24300-100	MAK 19QE453RP3	Spring Brake
EM31930	GUN 3295A	Brake Drum
EM31940	GUN 3141	Brake Drum
EM56810	MAK 745-281946	Valve
EM59270	MAK 2104-53147X	U-Joint
EM61320	MAK 67AX330	Roller Bearing
EM65800	MAK 46AX303	Bearing
EM67750	MAK 2104-5297X	U-Joint
EM67760	MAK 2104-5134X	U-Joint
EM68790	MAK 2104-51204X	U-Joint
EM68850	MAK 2104-51306X	U-Joint
EM68860	MAK 2104-51309X	U-Joint
EM68930	MAK 2104-5243X	U-Joint
EM69140	MAK 2104-5353X	U-Joint
EM80420	MAK 46AX474	Ball Bearing
ER07990	ROK 3278-A-1093	Spider
ER72460	ROK A-39878-1	Gear Set
ER70160	ROK A2-3235-T-1528	Case
ER76580	ROK A-36446-15	Gear Set
040112	CUM 4298220	Stud
050520	CUM 256838	Oil Filter
111760	CUM 4943105	Piston
131582	CUM 181256	Oil Pan Gasket
131632	CUM 4024957	Upper Gasket Set
131634	CUM 4024961	Upper Gasket Set

PAI REFERENCE	OEM REFERENCE	DESCRIPTION
131723	CUM 3804298	Upper Gasket Kit
136151	CUM 3067259	Shaft
131829	CUM 4024922	Upper Gasket Set
131888	CUM 3800861	Upper Gasket Kit
131902	CUM 4089717	Lower Gasket Kit
141370	CUM 4026889	Dipstick
171732	CUM AR3642	Main Bearing Kit
180150	CUM 202897	Diaphragm
180942	CUM 4026886	Idler Pulley
181021	N/A	Exhaust Manifold Kit
181177	CUM 3801935	Turbocharger
181199	CUM 4090042	Turbocharger Kit
181914	CUM 3684450	Water Pump Assembly
191963	CUM 3034827	Exhaust Valve
192152	CUM 3927255	Exhaust Valve
331128	N/A	Overhaul Gasket Kit
331144	N/A	Overhaul Gasket Kit
331183	N/A	Overhaul Gasket Kit
331188	N/A	Overhaul Gasket Kit
331190	N/A	Gasket / Seal Kit
331192	N/A	Gasket / Seal Kit
331197	CAT 6V4705	Gasket Kit
331330	CAT 8C8764	Gasket Kit
331376	CAT 2376367	Gasket Kit
331449	N/A	Gasket Kit
331561	CAT 3125931	Upper Gasket Set
331562	N/A	Lower Gasket Kit
331611	CAT 3550764	Head Gasket Kit
336020	CAT 4R9999	Excluder
340117	CAT 2459750	Stud
341370	CAT 7C3236	Oil Pan



STAY CURRENT

WORLD TESTED. PERFORMANCE PROVEN.

NOVEMBER 2019

PRICE REDUCED

PAI REFERENCE	OEM REFERENCE	DESCRIPTION
350411	CAT 9L6649	Belt
350413	CAT 4N8277	Belt
350415	CAT 7S9859	Belt
350468	CAT 7S9860	Belt Set
370005	CAT 6I1453	Crankshaft
381809	CAT 2243238	Water Pump Assy.
401034	NAV 1841896C96	Cylinder Kit
410073	NAV 1878672C1	Retainer
431284	NAV 1836197C1	Pan Gasket
431314	NAV 1836005C1	Cover Gasket
431356	NAV 1889321C95	Head Gasket Kit
450660	NAV 3596382C92	Fuel Sender
480030	NAV 675364C1	Oil Pump Hub
480830	NAV 2010529C91	Cable
481803	NAV 1815538C91	Water Pump
481805	NAV 1842664C92	Water Pump Assembly
497032	NAV 1665342C91	Gear Set
650511	DDC 23518671 F	Oil Filter
650540	DDC 23516489	Water Filter
671590	DDC 23526142	Bearing
671751	DDC 5192875	Main Bearing
681812	DDC 23526039	Water Pump Assembly
692021	DDC 23518572	Valve Guide
692026	DDC 5120930	Valve Guide
730411	PBT Q21-6030-004	Sensor
740343	FTL 21-26684-001	End Bumper
750116	HDK 66691-000H	Torque Rod End
750118	HDK 66670-000H	Torque Rod End
750127	HDK 64643-000	Saddle Assembly
750235	HDK 57068-004	Frame Hanger
750663	HDK 10371-000	Nut

PAI REFERENCE	OEM REFERENCE	DESCRIPTION
755090	HDK S-22828-1	Bracket Assembly
801182	MAK 21330684	Cylinder Kit
803241	GUN TW235K	Wheel Spoke
803330	GUN 3467B	Brake Drum
803935	MAK 30QS19	Door Striker
803940	MAK 55QS36	Door Handle
803941	MAK 55QS37	Door Handle
804295	MAK 10QK3105M	Spring Pin
804340	GDY 1R12-357	Air Spring
804347	GDY 2B12-440	Air Spring
808142	MAK 61KH465	Bull Gear
831103	VOL 85145352	Gasket Kit
831105	VOL 20710309	Lower Gasket Kit
842015	MAK 9MD47	Tank Strap
861610	MAK 20820662	Liner
900070	FUL 16252	Countershaft Gear
900466	FUL K-7035	Bearing & Seal Kit
940130	ROK B-40356-4	Gear Set
960065	DAN 6-4-7161	End Yoke
960066	DAN 5-4-6321-1	End Yoke



STAY CURRENT

ISO 9001 CERTIFIED

NOVEMBER 2019

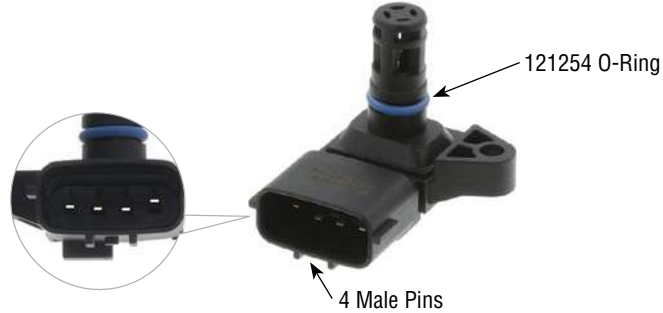

OEM REFERENCE	PAI REFERENCE	DESCRIPTION
CUM 2897332	050624	Dual Pressure / Temperature Kit(1.81in OAL) Includes Sensor (1)050623 O-Ring (1)121254

Application: Cummins Multiple



OEM REFERENCE	PAI REFERENCE	DESCRIPTION
CUM 2894940	050778	NOX Sensor

Application: Cummins Multiple



OEM REFERENCE	PAI REFERENCE	DESCRIPTION
MAK 22082849	853747	Stop Light Pressure Switch (2-6 psi Normally Open)(2.43in OAL)

Application: Mack / Volvo Multiple

AIR & ELECTRICAL

CAB & CHASSIS

DRIVE TRAIN

ENGINE

SENSORS



STAY CURRENT

WORLD TESTED. PERFORMANCE PROVEN.

NOVEMBER 2019

AIR & ELECTRICAL



OEM REFERENCE	PAI REFERENCE	DESCRIPTION
FTL 4640070030	740224	Cab Leveling Valve(8.78in OAL) (2-18/in NPT Ports)
Application: Freightliner Multiple		

CAB & CHASSIS



OEM REFERENCE	PAI REFERENCE	DESCRIPTION
MAK 40MH418BM MAK 40MH444M	EFC-1594	Fan Clutch (Hub Diameter: 2.56in) (6 Bolt Fan)(8in Clutch Diameter) (10.25in OAL)(1 V-Belt Pulley) (10 Groove Pulley / 6 Groove Pulley) (26in Maximum Fan Diameter)
Application: Mack Aset Engines		

DRIVE TRAIN



OEM REFERENCE	PAI REFERENCE	DESCRIPTION
MAK 17QF463P178	FTR-4628-178	Torque Rod(17-3/4in Center to Center) (1-1/4in Rod Diameter)(5/8in Mounting Hole)
Application: Mack Multiple		

ENGINE

SENSOR



OEM REFERENCE	PAI REFERENCE	DESCRIPTION
MAK 20QK3162	FCB-0900	Cab Shock Bracket(Frame Mount)
Application: Mack R/RB/RD Models		



STAY CURRENT

ISO 9001 CERTIFIED

NOVEMBER 2019



KEY	OEM REFERENCE	PAI REFERENCE	DESCRIPTION	APPLICATION
1	MAK 55QS36	803940	Door Handle(RH)	Mack MR Models
2	MAK 55QS37	803941	Door Handle(LH)	



OEM REFERENCE	PAI REFERENCE	DESCRIPTION
PBT 23-13857	730311	Hood Latch Kit
Application: Peterbilt Multiple		

AIR & ELECTRICAL

CAB & CHASSIS

DRIVE TRAIN

ENGINE

SENSOR



STAY CURRENT

WORLD TESTED. PERFORMANCE PROVEN.

NOVEMBER 2019

AIR & ELECTRICAL

CAB & CHASSIS

DRIVE TRAIN

ENGINE

SENSOR



OEM REFERENCE	PAI REFERENCE	DESCRIPTION
FUL 4303716	900698	Mainshaft Gear(1st)
Application: Fuller 14609 Series		



OEM REFERENCE	PAI REFERENCE	DESCRIPTION
FUL K-2808	EF66970HP	Auxiliary Drive Gear Kit Includes Main Drive Gear (1)EF59310HP Retaining Ring (1)EF27830 Spacer (1)EF10370 Washer (1)EF10290
Application: Fuller 16713 / 16718 RT		



OEM REFERENCE	PAI REFERENCE	DESCRIPTION
NAV 481107C91	497190	Idler Gear
Application: International J340S / J380S		



OEM REFERENCE	PAI REFERENCE	DESCRIPTION
MAK 751KB498	GGB-6657	Maindrive Compound Gear (Use w/ Mainshaft GMS-6656 & GSA-2505)
Application: Mack T2130 and T2180		



STAY CURRENT

ISO 9001 CERTIFIED

NOVEMBER 2019



OEM REFERENCE	PAI REFERENCE	DESCRIPTION
---------------	---------------	-------------

CUM 3801935	181177	Turbocharger
-------------	------------------------	--------------

Application: Cummins 855



OEM REFERENCE	PAI REFERENCE	DESCRIPTION
---------------	---------------	-------------

CUM 3802906	181175	Turbocharger Kit Includes Turbocharger (1)181176 Gasket Kit (1)132050 Includes Gaskets (1)131480 (1)136103
-------------	------------------------	--

Application: Cummins 4B 3.9L



OEM REFERENCE	PAI REFERENCE	DESCRIPTION
---------------	---------------	-------------

CUM 4022823	191817	Camshaft
-------------	------------------------	----------

Application: Cummins ISM / M11



OEM REFERENCE	PAI REFERENCE	DESCRIPTION
---------------	---------------	-------------

CUM 5260634	180127	Fuel Transfer Pump(In-Line)(24 vdc)
-------------	------------------------	-------------------------------------

Application: Cummins ISB / QSB

CAB & CHASSIS

DRIVE TRAIN

ENGINE

SENSOR



STAY CURRENT

WORLD TESTED. PERFORMANCE PROVEN.

NOVEMBER 2019

AIR & ELECTRICAL

CAB & CHASSIS

DRIVE TRAIN

ENGINE

SENSOR



OEM REFERENCE	PAI REFERENCE	DESCRIPTION
DDP 23532333	631250HP	High Performance Head Set
Application: Detroit Diesel Series 60		

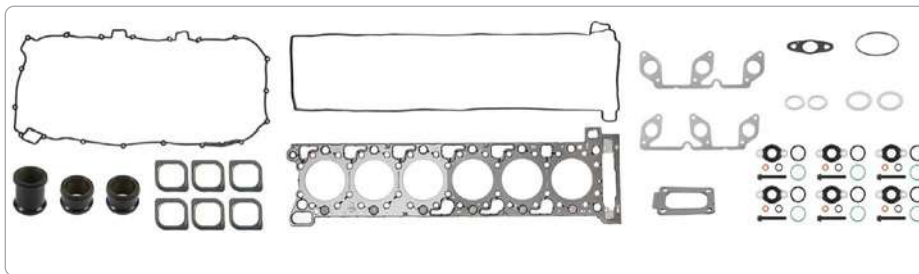

OEM REFERENCE	PAI REFERENCE	DESCRIPTION
N/A	631395	Cylinder Head Gasket Kit Includes Head Gasket (1)631265 Injector Kits (6)621245 Coolant Tubes (2)691838 (1)691837 Gaskets (1)631352 (1)631360 (1)631380 (6)631381 (1)631382 (1)631383 (1)631385 (1)631388 (1)631396 Washers (2)640092 (2)842031
Application: Detroit Diesel DD15		



STAY CURRENT

ISO 9001 CERTIFIED

NOVEMBER 2019



OEM REFERENCE	PAI REFERENCE	DESCRIPTION
---------------	---------------	-------------

MAK 22093991	841276	Oil Filter Housing
--------------	--------	--------------------

Application: Mack MP 8 / Volvo D13



Front



Back

OEM REFERENCE	PAI REFERENCE	DESCRIPTION
---------------	---------------	-------------

MAK 22986942	860048	Flywheel Housing
--------------	--------	------------------

Application: Mack MP8 / Volvo D13



OEM REFERENCE	PAI REFERENCE	DESCRIPTION
---------------	---------------	-------------

VOL 425622	831125	Oil Pan Gasket
------------	--------	----------------

Application: Volvo D12

CAB & CHASSIS

DRIVE TRAIN

ENGINE

SENSOR



STAY CURRENT

WORLD TESTED. PERFORMANCE PROVEN.

NOVEMBER 2019

ADDITIONAL NEW ITEMS

PAI REFERENCE	OEM REFERENCE	DESCRIPTION
111084HP	MAH 09300738	Piston Pin
111300HP	CUM 3929161	Piston
111468HP	CUM 3946053	Piston
111745	CUM 4990586	Piston Kit
121407	CUM 4994273	Sealing Ring
121412	CUM 3936302	Seal
172055	CUM 4938953	Main Bearing
172056	CUM 4938946	Main Bearing
172060	CUM 4955873	Bearing Kit
331688	CAT 9N0237	Gasket
331691	CAT 9L8837	Gasket
381242	CAT 8H4320	Ball Bearing
410022HP	NAV 1823930C1	Piston
431366	NAV 2015983C1	Exhaust Gasket
431367	NAV 3853371C1	Exhaust Gasket
431368	NAV 2593986C1	Exhaust Gasket
505160HP	CUM 4955251	Ring Set
631389	DDC A4722030880	Gasket
631390	DDC A4722030980	Gasket
900575	FUL 4304724	Seal
840086	MAK 277GC23M	Plug

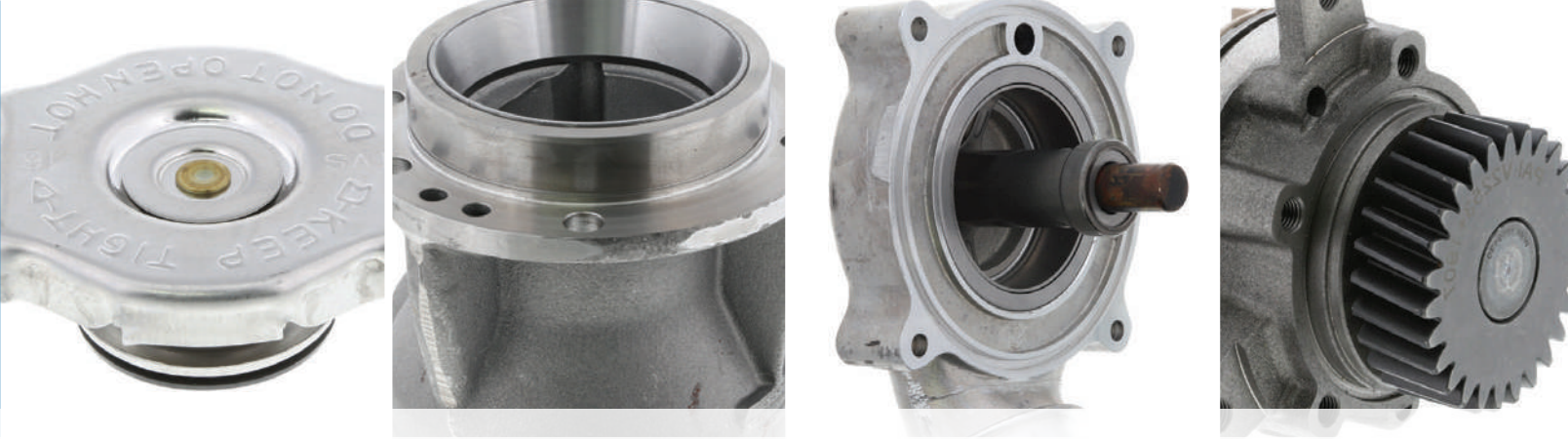

PAI MONTHLY NEWSLETTER - DECEMBER 2019 EDITION

STAY CURRENT



World Tested. Performance Proven.

DECEMBER 2019



STAY CURRENT

ISO 9001 CERTIFIED

DECEMBER 2019

TABLE OF CONTENTS

Price Reduced	2
Feature Item	3
Sensors & Components	4
Cab & Chassis Components	5
Drive Train Components	6-7
Engine Components	8-10
Engine Kits	11
Additional New Items	12



STAY CURRENT

WORLD TESTED. PERFORMANCE PROVEN.

DECEMBER 2019

PRICE REDUCED

PAI REFERENCE	OEM REFERENCE	DESCRIPTION
EE92210	EAT 217981	Gear Set
EF61070	MAK 2104-106C939	Shaft
050741	CUM 4921728	Sensor Kit
060163	CUM 4962732	Cylinder Head Assy.
141344	CUM 4898036	Oil Pan
171816HP	CUM 3901430	Rod Bearings
180124	CUM 4983585	Fuel Pump Assy.
181006	N/A	Exhaust Manifold Kit
181218	CUM 4089754	Turbocharger
331165	CAT 2486740	Gasket Kit
331226	CAT 2601534	Gasket Kit
341372	CAT 2273006	Oil Pan
342149	CAT 9X6451	Plug Kit
350603	CAT 2746717	Boost Sensor
350604	CAT 1259859	Oil Sensor
350610	CAT 2661466	Throttle Sensor
351525	CAT 9N5461	Bushing
451571	NAV 3558776C1	Hood Latch
600918	DDC 23532885	Cylinder Kit
605010	DDC 23503747	Piston Ring Set
631388	DDC A4720160780	Housing Gasket
650664	DDC A0041534228	Temperature Sensor
650676	DDC A0071530828	Position Sensor
691924	DDC 23521681	Camshaft
740145	FTL 16-18035-000	Bushing
808097	MAK 98KH41	Shift Fork
853757	MAK 64MT476	Pressure Sensor
900435	FUL A-7786	Yoke
960140	DAN 250-82-21X	Yoke
C15101-010HP	N/A	Engine Kit
C16601-010	N/A	Engine Kit



STAY CURRENT

WORLD TESTED. PERFORMANCE PROVEN.

DECEMBER 2019

AIR & ELECTRICAL

CAB & CHASSIS

DRIVE TRAIN

ENGINE

SENSORS

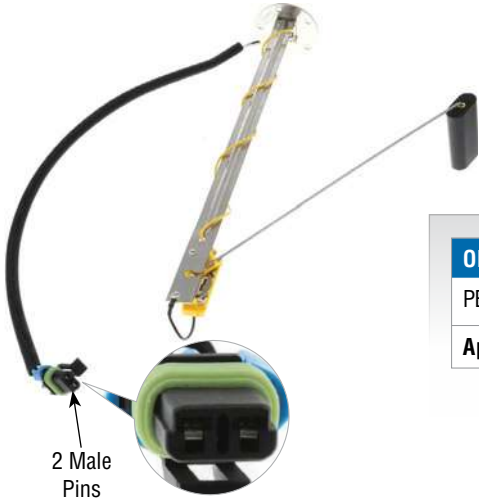

OEM REFERENCE	PAI REFERENCE	DESCRIPTION
PBT 5549-13715-26	730413	Fuel Level Sensor(12in / 13.50in)
Application: Kenworth / Peterbilt Multiple		



OEM REFERENCE	PAI REFERENCE	DESCRIPTION
MAK 20489118	853746	Pressure Switch(2.44in OAL)
Application: Mack / Volvo Multiple		



OEM REFERENCE	PAI REFERENCE	DESCRIPTION
MAK 21164790	853703	EGR Sensor(16in OAL)
Application: Mack Multiple		



STAY CURRENT

ISO 9001 CERTIFIED

DECEMBER 2019



OEM REFERENCE	PAI REFERENCE	DESCRIPTION
MAK 85151255	ERC-8319	Radiator Pressure Cap(16 psig)
Application: Mack / Volvo Multiple		



OEM REFERENCE	PAI REFERENCE	DESCRIPTION
MAK 4ME41112M	803614	Exhaust Pipe(w/ Pyro Hole)
Application: Mack CV Models		



OEM REFERENCE	PAI REFERENCE	DESCRIPTION
MAK 9MD47	842015	Surge Tank Mounting Strap
Application: Mack CH / CHN / DT / CTP / CV Models		



OEM REFERENCE	PAI REFERENCE	DESCRIPTION
NAV 3604375C1	451362	Windshield Washer Fluid Pump(3.38in Height)
Application: International 1000 / 3000 / 4000 / 7000 / 8000 Series		

AIR & ELECTRICAL

CAB & CHASSIS

DRIVE TRAIN

ENGINE

SENSOR



STAY CURRENT

WORLD TESTED. PERFORMANCE PROVEN.

DECEMBER 2019



OEM REFERENCE	PAI REFERENCE	DESCRIPTION
FUL S-2890	900661	Pinion Assembly(2in-14 Spline-Pull) Includes Pinion (1)900660 Bushing (1)EF34050
Application: Fuller RTLO22918 A / B		

AIR & ELECTRICAL

CAB & CHASSIS

DRIVE TRAIN

ENGINE

SENSOR



OEM REFERENCE	PAI REFERENCE	DESCRIPTION
MAK 22937784	808106	Pinion Housing Assembly(9.27in O.D.)
Application: Mack CRD 150 Front Differential Assembly		

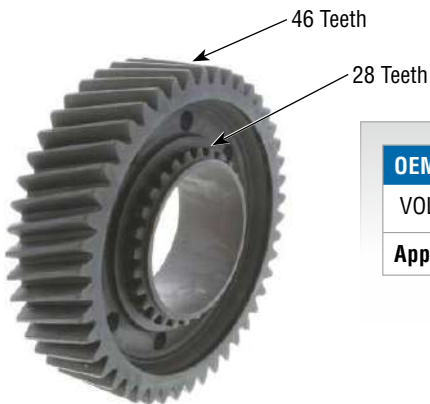

OEM REFERENCE	PAI REFERENCE	DESCRIPTION
VOL 20906486	806780	Mainshaft Gear(1st & 6th)(46 Teeth)(28 Teeth)
Application: Volvo I-Shift		



STAY CURRENT

ISO 9001 CERTIFIED

DECEMBER 2019



OEM REFERENCE	PAI REFERENCE	DESCRIPTION
MAK 31KN370	808102	Power Divider Cam(Outer)(43 Splines) (8.5in OD)
Application: Mack CRDPC 92/112 and CRD/CRDPC 93 Differentials		



OEM REFERENCE	PAI REFERENCE	DESCRIPTION
MAK 32KH228A	BSD-0791HP	High Performance Differential Spider
Application: Mack CRD 150 / CRDPC 202 / CRD 203 / CRDPC 92 / 112 / CRD 93 / 113 & CRD 93A Differentials		

AIR & ELECTRICAL

CAB & CHASSIS

DRIVE TRAIN

ENGINE

SENSOR



STAY CURRENT

WORLD TESTED. PERFORMANCE PROVEN.

DECEMBER 2019



FRONT



BACK

OEM REFERENCE	PAI REFERENCE	DESCRIPTION
CAT 1302802	360473E	Flywheel Housing
Application: Caterpillar 3400 Series		

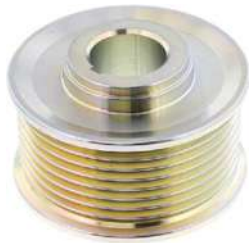

OEM REFERENCE	PAI REFERENCE	DESCRIPTION
CUM 3965147	180865	Alternator Pulley(2-34in Diameter)(8 Groove)
Application: Cummins Multiple		



OEM REFERENCE	PAI REFERENCE	DESCRIPTION
CUM 5362256	180136	Fuel Transfer Pump Assembly(24 VDC)
Application: Cummins ISX		

AIR & ELECTRICAL

CAB & CHASSIS

DRIVE TRAIN

ENGINE

SENSOR



STAY CURRENT

ISO 9001 CERTIFIED

DECEMBER 2019



OEM REFERENCE	PAI REFERENCE	DESCRIPTION
CUM 4975069	132041	Oil Pan Gasket

Application: Cummins ISX/QSX12



OEM REFERENCE	PAI REFERENCE	DESCRIPTION
N/A	181023	Exhaust Manifold Kit Includes Front Manifold (1)181035 Rear Manifold (1)181036 Gaskets (1)131480 (6)131599 (1)131603 Screws (10)040028 (2)040097 Nuts (4)040062 Studs (4)040110 O-Ring (1)121289

Application: Cummins 6B / 5.9 Liter



OEM REFERENCE	PAI REFERENCE	DESCRIPTION
DDC A4722000115	681832	Thermostat(188°)

Application: Detroit Diesel DD13 / DD15

CAB & CHASSIS

DRIVE TRAIN

ENGINE

SENSOR



STAY CURRENT

WORLD TESTED. PERFORMANCE PROVEN.

DECEMBER 2019

AIR & ELECTRICAL



OEM REFERENCE	PAI REFERENCE	DESCRIPTION
DDC RFE4E00001	609910X	Fule Injector Assembly(Reman)

Application: Detroit Diesel 60 Series

CAB & CHASSIS



OEM REFERENCE	PAI REFERENCE	DESCRIPTION
MAK 85124753	891925	Camshaft

Application: Mack MP8 / Volvo D13

DRIVE TRAIN



OEM REFERENCE	PAI REFERENCE	DESCRIPTION
MAK 85124753	842027	DPF Clamp Kit(14in) Includes Clamps (2)842016 Gaskets (2)831106

Application: Mack Multiple

ENGINE

SENSOR



OEM REFERENCE	PAI REFERENCE	DESCRIPTION
VOL 20734268	801133E	Water Pump

Application: Volvo D12



STAY CURRENT

ISO 9001 CERTIFIED

DECEMBER 2019

NEW AVAILABLE ENGINE KITS

OEM REFERENCE	PAI REFERENCE	APPLICATION
CUM 4376171	ISX116-113	Cummins ISX



STAY CURRENT

WORLD TESTED. PERFORMANCE PROVEN.

DECEMBER 2019

ADDITIONAL NEW ITEMS

PAI REFERENCE	OEM REFERENCE	DESCRIPTION
171816F	CUM 3901430	Rod Bearing Kit
172059	CUM 4955872	Bearing Kit
351525	CAT 9N5461	Bushing
421110	NAV 7092074C1	O-Ring
505160HP	CUM 4955251	Piston Ring Set
611007HP	DDC A4720370320	Pin
640093	DDC A4721420853	Manifold Spacer
640125	DDC 09421740	Cup Plug
671575A	N/A	Rod Bearing Kit
821082	VOL 968617	O-Ring
821083	VOL 943177	O-Ring
821084	VOL 969198	O-Ring
821085	VOL 975675	O-Ring
821087	VOL 976068	O-Ring
821091	VOL 1677370	Sealing Ring
840037	MAK 25501625	Screw
841270	VOL 22995773	Housing Nipple
900550	FUL 5556507	Bearing
940209	ROK 1227P900	Pinion Nut



PAI MONTHLY NEWSLETTER - JANUARY 2021 EDITION

STAY CURRENT



World Tested. Performance Proven.

JANUARY 2021



STAY CURRENT

ISO:9001 CERTIFIED

Table of Contents

Price Reduced	2
Featured Item	3
High Performance Components	4-5
Sensors	6
Cab & Chassis Components	7
Engine Components	8-10
New Available Engine Kits	11
Additional New Items	12



STAY CURRENT

WORLD TESTED. PERFORMANCE PROVEN.

Price Reduced

PAI Reference	OEM Reference	Description
GKP-3498SS	CUM 3945094	Plug
GGB-6733	MAK 764KB468E	Gear
BRP-7866	MAK 24KH1873	Gear Set
BRP-7866-HP	MAK 24KH1873	HP Gear Set
BRP-7877	MAK 24KH1846BP6	Gear Set
ECM-8788	MAK 454GC5232A	Camshaft
EF67830	FUL 4303409	Gear
040137	CUM 3678804	Head Bolt
050774	CUM 4326873	Nox Sensor
060085	CUM 3024442	Timing Cover
060086	CUM 3076496	Timing Cover
141338	CUM 3039296	Oil Cooler Spring
340036	CAT 2245126	Screw
340038	CAT 2384664	Screw
340120	CAT 8T7044	Stud
360473	CAT 1302802	Flywheel Housing
360473E	CAT 1302802	Flywheel Housing
391865	CAT 2241270	Valve Insert
450608	NAV 1875784C93	Sensor Kit
641296OEM	DDC A4710108113	Oil Pan
801095	MAK 85115603	Fan Clutch
805027	MAK 634GC5337M3	Flywheel Housing
808087	MAK 68KH3234	Drive Axle
808088	MAK 68KH3234P2	Drive Axle
853752	MAK 22181342	EGR Sensor
900078	FUL 4304542	Countershaft Gear
6BS106-051HP	N/A	HP Engine Kit
6BS106-076HP	N/A	HP Engine Kit
6CS106-001	N/A	Engine Kit
6CS106-007	N/A	Engine Kit
6CS106-026	N/A	Engine Kit
6CS106-027	N/A	Engine Kit

PAI Reference	OEM Reference	Description
6CS106-031	N/A	Engine Kit
6CS106-032	N/A	Engine Kit
6CS106-037	N/A	Engine Kit
6CS106-038	N/A	Engine Kit
6CS106-043	N/A	Engine Kit
6CS106-044	N/A	Engine Kit
ISX119-022	N/A	Engine Kit
MV1303-001	MAK 85138502	Engine Kit



STAY CURRENT

WORLD TESTED. PERFORMANCE PROVEN.

Featured Item: Caterpillar Flywheel Housing Applications - 3406E, C15, C16, C18

PAI's Flywheel Housings are thoroughly tested to ensure optimum fit and performance on specific vehicle applications. This replacement Flywheel Housing fits Caterpillar 3406E, C15, C16, C18 engines, replaces OE 1302802.

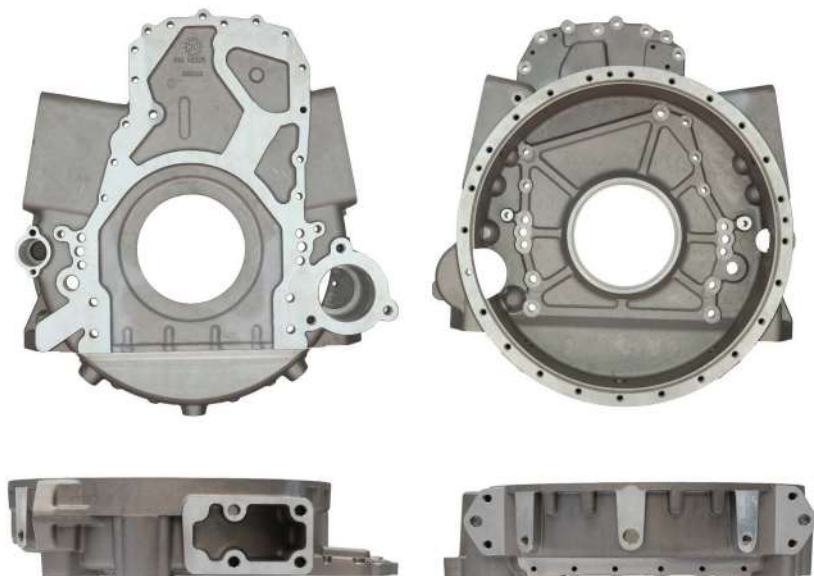

**Direct Replacement for
OE Part 1302802**

**Caterpillar 3406E, C15,
C16, C18 Application**

OEM Recommended Specs

High-Grade Material

2-Year Warranty

PAI Reference	OEM Reference
360473	CAT 1302802
Material: Aluminum	Color/Finish: Silver
SAE#: 1 (24) 7/16-14 Transmission Mounting Holes	
Description: Flywheel Housing	
Application: Caterpillar 3406E, C15, C16, C18	

TWO YEAR WARRANTY Unlimited Mileage 



HIGH PERFORMANCE

WORLD TESTED. PERFORMANCE PROVEN.



OEM Reference	PAI Reference	Description
FUL 21263	EF62180HP	HP Countershaft Drive Gear
Application: Fuller 14210B / 15210C		



OEM Reference	PAI Reference	Description
FUL 4302421	900024HP-010	HP Mainshaft Gear(2nd) (10 pc. Bulk Packaging)
Application: Fuller 12210 / 14210 / 15210 / 16210 / 18210		



OEM Reference	PAI Reference	Description
FUL 4303120	900655HP	HP Countershaft Drive Gear
Application: Fuller FRO 14210C		



HIGH PERFORMANCE

WORLD TESTED. PERFORMANCE PROVEN.



OEM Reference	PAI Reference	Description
FUL 4303121	900069HP-010	HP Countershaft Main Drive Gear (10 pc. Bulk Packaging)
Application: Fuller 14210B / 15210C		



OEM Reference	PAI Reference	Description
FUL 4304510	EF89530HP	HP Maindrive Gear
Application: Fuller RTLO 16918		



OEM Reference	PAI Reference	Description
FUL 4304642	900021HP-010	HP Maindrive Gear (10 pc. Bulk Packaging)
Application: Fuller 15210 / 17210		



STAY CURRENT

WORLD TESTED. PERFORMANCE PROVEN.



OEM Reference	PAI Reference	Description
CUM 4358939	050738	EGR Differential Pressure Sensor (Includes (2) M8x1.25 x 25mm Screws w/ O-Rings)
Application: Cummins ISX15		

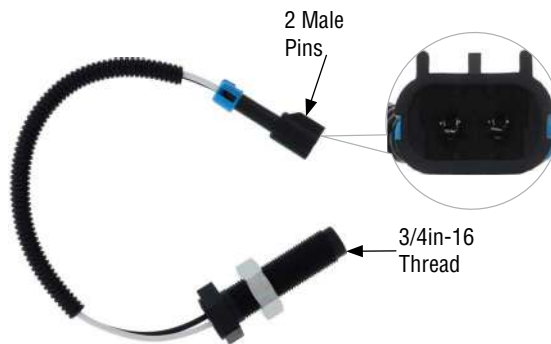

OEM Reference	PAI Reference	Description
MAK 25166488	845078	Speed Sensor(11in Lead Line)
Application: Mack / Volvo Multiple		

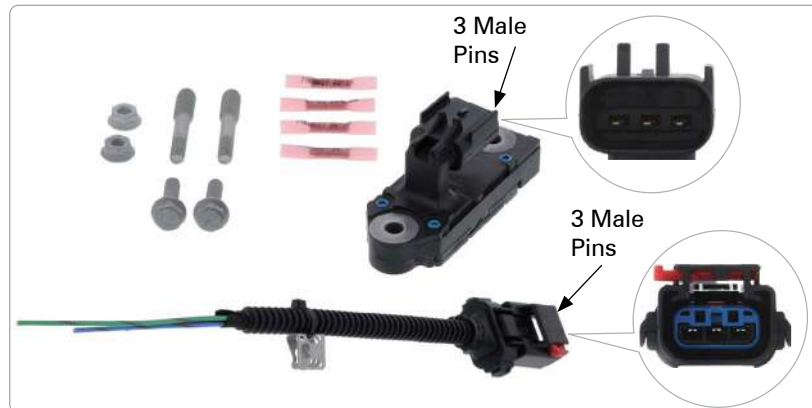

OEM Reference	PAI Reference	Description
DDC 23539639	650683OEM	Differential Pressure Sensor Kit Includes Sensor (1)650682OEM Studs (2)640105 Nuts (2)640037 Connector Assy. (1)854059
Application: Detroit Diesel DD15		

Air & Electrical
Cab & Chassis
Drivetrain
Engine
Sensors



STAY CURRENT

ISO:9001 CERTIFIED

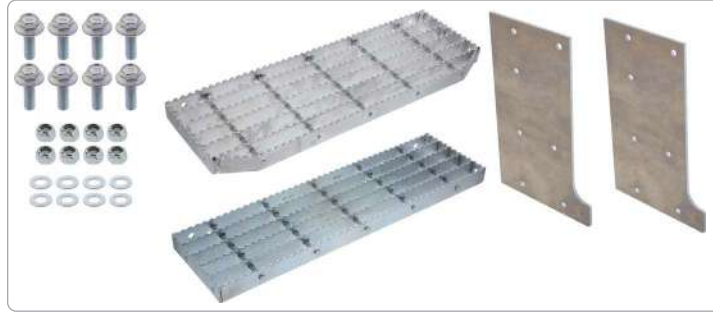

OEM Reference	PAI Reference	Description
N/A	803860	Cab Step Kit Includes Plates (2)803882 Upper Step (1)803888 Lower Step (1)803889 Screws (8)FSC-0149 Nuts (8)FNU-0268 Washers (8)842042

Application: Mack MC / MR



OEM Reference	PAI Reference	Description
NAV 2507408C1	403970	Cab Suspension Air Spring

Application: International 4000 / 7000 & 8000



OEM Reference	PAI Reference	Description
MAK 38MH428M	EFC-1558OEM	Fan Clutch(4.18in Hub Diameter) (7in Fan Pilot)(5.25in Length) (26in Maximum Fan Diameter)

Application: Mack Aset

Air & Electrical

Cab & Chassis

Drivetrain

Engine

Sensors



STAY CURRENT

WORLD TESTED. PERFORMANCE PROVEN.



OEM Reference	PAI Reference	Description
CAT 1601429	341373OEM	Oil Pan
Application: Caterpillar C15		



OEM Reference	PAI Reference	Description
CAT 1879381	391908E	Camshaft
Application: Caterpillar 3406E		



OEM Reference	PAI Reference	Description
CUM 2830266	180138	Fuel Pump Kit Includes Fuel Pump (1)180139 Connector (2)042172 Washers (2)842049 Gaskets (2)131532
Application: Cummins 4B / 3.9L		



OEM Reference	PAI Reference	Description
CUM 3029848	141390OEM	Oil Transfer Tube
Application: Cummins N14 / 855		

Air & Electrical

Cab & Chassis

Drivetrain

Engine

Sensors



STAY CURRENT

ISO:9001 CERTIFIED



OEM Reference	PAI Reference	Description
CUM 5313086	141324	Oil Pump
Application: Cummins ISB		



OEM Reference	PAI Reference	Description
DDC 23532981	680350OEM	Fuel Transfer Pump (Gasket Included)
Application: Detroit Diesel Series 60		



OEM Reference	PAI Reference	Description
DDC 23513939	645067OEM	Rocker Injector Assembly
Application: Detroit Diesel Series 60		



OEM Reference	PAI Reference	Description
DDC 23535540	680353OEM	Fuel Transfer Pump (Sealing Ring Included)
Application: Detroit Diesel Series 60		

Air & Electrical

Cab & Chassis

Drivetrain

Engine

Sensors



STAY CURRENT

WORLD TESTED. PERFORMANCE PROVEN.



OEM Reference	PAI Reference	Description
NAV 2511369C91	480233OEM	Fuel Pump
Application: International DT530E		



OEM Reference	PAI Reference	Description
NAV 1889335C94	480272OEM	EGR Kit
Application: International DT530E		



Inside



Outside

OEM Reference	PAI Reference	Description
MAK 634GC5337M3	805027	Flywheel Housing
Application: Mack ASET		

PRICE REDUCED

Air & Electrical

Cab & Chassis

Drivetrain

Engine

Sensors



STAY CURRENT

ISO:9001 CERTIFIED

New Engine Kits Available

OEM Reference	PAI Reference	Application
N/A	ISX106-113	Cummins ISX
N/A	855035-001HP	Cummins 855
N/A	MV1101-001	Mack MP7 / Volvo D11
MAK 85119956	MV1301-001	MacK MP8 / Volvo D13



STAY CURRENT

WORLD TESTED. PERFORMANCE PROVEN.

Additional New Items

PAI Reference	OEM Reference	Description
040075OEM	CUM 3900227	Screw
042230OEM	CUM 213082	Washer
045141	CUM 3896648	Plug
171817HP	CUM 3901431	HP Rod Bearing
305002OEM	CAT 2476130	Ring
305044OEM	CAT 3064014	Ring
340040OEM	CAT 8S9191	Screw
342147	CAT 3603682	Plug
421246OEM	NAV 1803190C1	O-Ring
442029	NAV 113933H	Plug
505179	CUM 4376565	Ring Set
640094OEM	DDC N000000001068	Washer
640135OEM	DDC A0019984450	Plug
691970OEM	DDCA 4720530025	Retainer

STAY CURRENT

JANUARY 2021 EDITION

PA INDUSTRIES, INC.
STAY CURRENT



ISO 9001
CERTIFIED

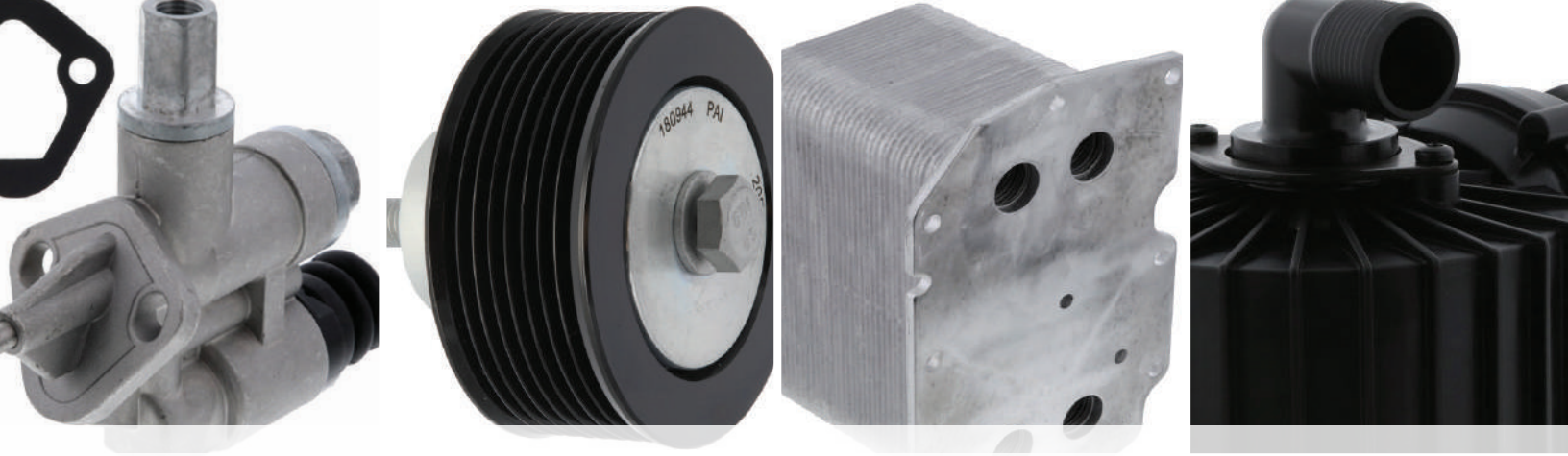

PAI MONTHLY NEWSLETTER - FEBRUARY 2021 EDITION

STAY CURRENT



World Tested. Performance Proven.

February 2021



STAY CURRENT

ISO:9001 CERTIFIED

Table of Contents

Price Reduced	2
Sensors	3
Featured Item	4-5
Cab & Chassis Components	6
Engine Components	7-10
New Available Engine Kits	11
Additional New Items	12



STAY CURRENT

WORLD TESTED. PERFORMANCE PROVEN.

Price Reduced

PAI Reference	OEM Reference	Description	PAI Reference	OEM Reference	Description
GSF-0655	MAK 575KB3135A	Shift Fork	750248	HDK 65079-001	Hanger Bracket
MST-4355	LNV 78989	Stator	750399	HDK 19111-001	Saddle Stud
FSB-4964	MAK 52QK434B	Cap	750403	HDK 30550-002	Screw
GWA-5983	MAK 223KD316A	Washer	750432	HDK 22962-002	Washer
GMS-6688	MAK 615KC4208	Main Shaft	750442	MAK 44RU2394M	Washer
BOS-6990	MAK 88AX378	Oil Seal	750751	HDK 60961-082	Torque Rod End Kit
BSP-7361	MAK 22QF474	Spindle	750817	MAK 2QK4145	Front Spring Assy.
EE94210	EAT 95539	Gear Set	750834	HDK 052530-000	Spring Assembly
EF62180HP	FUL 21263	HP Gear	750857	MAK 4QK4124M	Spring Assembly
EM37540	MAK 20QE3373	Valve	750859	MAK 4QK4156M	Spring Assembly
EM43600	MAK 64SM21	Diaphragm	750860	MAK 4QK4005A	Spring Assembly
060171	CUM 3977225	Cylinder Head	755049E	NWY 90054082	Control Valve
141283	CUM 3687414	Oil Pan Kit	755152	HDK S-23114	Air Spring
141283E	CUM 3687414	Oil Pan Kit	803738	MAK 85144423	Height Control Valve
171651	CUM 3096362	Crankshaft	803908	MAK 8MB429	Fuel Tank Strap
381181	CAT 1030651	Turbocharger	803967	MAK 20QL353M	Radiator Isolator
480063	NAV 1878571C95	Fuel Regulator Kit	804098	MAK 20843764	Oil Filter
490018	NAV 1894238C92	Camshaft Kit	808103	MAK 36KN428	Pinion Assembly
497055	NAV 1665363C91	Gear Set	842014	VOL 21048521	V-Band Clamp
631371	DDC A4720150380	Cover Gasket	900024HP	FUL 4302421	HP Mainshaft Gear
640015-019	N/A	Cylinder Head Bolt Kit	900076HP-010	FUL 4303184	Gear
641280E	DDC 23522282	Oil Pan Kit	ISX108-129	N/A	Engine Kit
645020	DDC 8920172	Dowel Pin	ISX111-033	CUM 4376177	Engine Kit
650670	DDC 23503011	Sensor	ISX111-097	CUM 4376427	Engine Kit
671655	DDC A4720310701	Crankshaft	ISX111-161	N/A	Engine Kit
680350E	DDC 23532981	Fuel Pump	466112-001	NAV 1836300C98	Engine Kit
740344	FTL A21-26683-000	Bumper			
750134	HDK 31017-022L	Saddle Assembly			
750187	HDK 57359-000	Bushing			
750191	HDK 43146-000L	Spring Pin Kit			
750245	HDK 60219-000	Torque Rod Kit			



STAY CURRENT

ISO:9001 CERTIFIED



OEM Reference	PAI Reference	Description
MAK 22946032	853762OEM	Particulate Matter Soot Sensor (37.5in Cable Length)
Application: Mack MP8 / Volvo D13		



OEM Reference	PAI Reference	Description
CUM 3408503	050700E	Position Sensor (Includes (1)EGA-3061 O-Ring) (9.75in OAL)(4.75in Lead Length)
Application: Cummins Multiple		

Air & Electrical

Cab & Chassis

Drivetrain

Engine

Sensors

Mack MP8/Volvo D13 Replacement Engine Kit

Mack MP8 Engine



PAI's Aftermarket Single Kit Solution

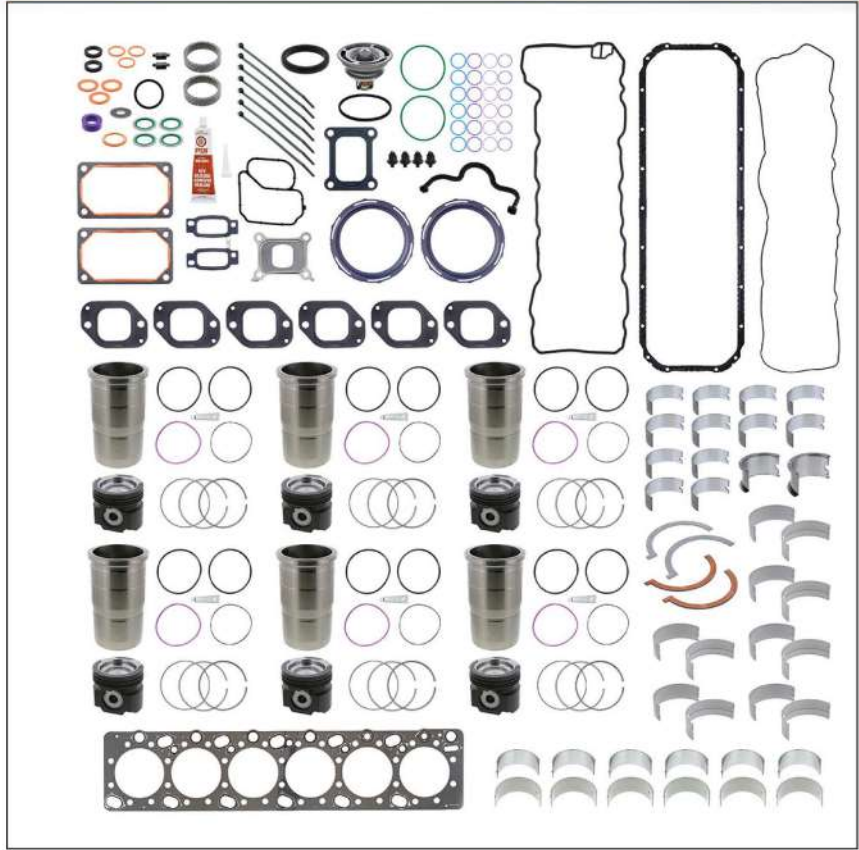

Volvo D13 Engine



Previous Engine Kits

PAI's Single Kit Solution

MP8101-001
D13101-001



MV1301-001

PAI Piston Ref. 811024 | OE Ref. 21041800

MP8102-001
D13102-001



MV1302-001

PAI Piston Ref. 811022 | OE Ref. 21105177

MP8103-001 / 037
D13103-001 / 037



MV1303-001

PAI Piston Ref. 811028 | OE Ref. 21170742

MP8140-001
D13140-001



MV1340-001

Pistonless Kit

Use of other manufacturers' names, part numbers or trademarks are for the informational and identification purposes only.

PAI Mack MP8 / Volvo D13 Components

Mack. MP8 / Volvo. D13 Components		
PAI Ref.	OEM Ref.	Description
891991	85124276	Copper Injector Sleeve Kit
891989	85137065	Stainless Injector Sleeve Kit
845041	20740804	Intake Valve Seat
845042	20530103	Exhaust Valve Seat
892000	3183210	Outer Valve Spring
892001	3183211	Inner Valve Spring
845010	20740798	Intake Valve
845011	20768519	Exhaust Valve
842060	20864662	Valve Seal
845035	20510743	Valve Retainer
845030	20510747	Valve Lock
840025	1547419	Head Bolt
805050	20747511	Piston Ring Set
841925	20824906	Lube Pump
842023	85113698	EGR Clamp Kit
841955	85136428	EGR Cooler Kit
880832	21307197	Fuel Steering Pump
821020	276948	Injector O-Ring Kit
804099	20972295	Secondary Fuel Filter
891970	20486222	Crankshaft
836020	20441481	Rear Crank Seal (Teflon)
836021	1543896	Rear Crank Seal (Neoprene)
836018	21347087	Front Crank Seal
891922	20742607	Camshaft
891923	20742610	Camshaft
891924	20920956	Camshaft
891925	21198713	Camshaft
841950	20505537	Oil Cooler (MP8)
801131	85124623	Water Pump
801138	20995158	Water Pump Kit w/ Housing
805031	21508089	Oil Cooler Plate Kit
801161	20903074	Oil Filter Pad Thermostat
801170	21905526	Thermostat Housing
841977	85115784	Doser Kit

Mack. MP8 / Volvo. D13 Components		
PAI Ref.	OEM Ref.	Description
801088	85118917	Fuel Pump Kit
841201	21368390	Oil Pan Kit (Plastic Pan)
831049	20541940	Oil Pan Gasket (For 841201)
841206	21585801	Oil Pan Kit (Steel Pan)
831051	21293367	Oil Pan Gasket (for 841206)
871130	20876840	Connecting Rod
FSU-0569	20898038	Fuel Pressure Sensor
853707	64MT377M	Temperature Sensor Kit
853709	20513340	Coolant Temperature Sensor
845069	20513343	Tachometer Sensor
853762	22946032	Soot Sensor
853703	21164790	EGR Sensor
853724	21097978	Emissions Boost Sensor
853730	64MT490M	Air Temperature Sensor
853721	21225020	Exhaust Temperature Sensor
845077	64MT457M	Turbocharger Speed Sensor
853714	21521353	Oil Level / Temperature Sensor
831121	21111305	Turbocharger
831122	85136172	Turbocharger
831123	85141061	Turbocharger
891951X	21244717X	Reman Fuel Injector Assembly
891952	21371672	Fuel Injector
880850	21407621	DEF Injector Kit
841276	22093991	Oil Filter Housing
804095	85114535	Filter Kit
805061	20911049	Exhaust Manifold
841955	85136428	EGR Cooler Kit
841979	85133799	EGR Valve Kit
860048OEM	22986942	Flywheel Housing
860047OEM	22992289	Timing Cover (Plastic)
831127	21383310	Timing Gasket (Plastic Cover)
831036	20817742	Timing Gasket (Metal Cover)
860046OEM	22190294	Timing Cover Plate
EBG-8688 	306DD	Pilot Bearing



STAY CURRENT

WORLD TESTED. PERFORMANCE PROVEN.



OEM Reference	PAI Reference	Description
MAK 13QC59M	804288OEM	Drag Link & Rod End Assembly (37in Center to Center)
Application: Mack CH 613		

Air & Electrical

Cab & Chassis

Drivetrain

Engine

Sensors



STAY CURRENT

ISO:9001 CERTIFIED



OEM Reference	PAI Reference	Description
N/A	340098	Exhaust Manifold Hardware Kit Includes Spacers (1)340137 (2245450) (11)340140 (1083612) Studs (11)340110 (1061792) (1)340111 (1061793) Nuts (12)340061 (2N2766)
Application: Caterpillar C15		



OEM Reference	PAI Reference	Description
CUM 3400884	180944	Serpentine Belt Idler Pulley (8 Groove)
Application: Cummins B Series		



OEM Reference	PAI Reference	Description
CUM 3076491	181941OEM	Water Transfer Tube
Application: Cummins N14		

Sensors Engine Drivetrain Cab & Chassis Air & Electrical



STAY CURRENT

WORLD TESTED. PERFORMANCE PROVEN.



OEM Reference	PAI Reference	Description
CUM 3921954	191836OEM	Camshaft Gear(72 Teeth)
Application: Cummins 6B 5.9L / ISB		



OEM Reference	PAI Reference	Description
CUM 3932545	180194	Fuel Solenoid(12 VDC)
Application: Cummins Multiple		



OEM Reference	PAI Reference	Description
CUM 4988751	180133	Fuel Pump(108-230 LPH) (1250 RPM)(1/4in-18 Inlet)
Application: Cummins 6B		

Air & Electrical

Cab & Chassis

Drivetrain

Engine

Sensors



STAY CURRENT

ISO:9001 CERTIFIED



OEM Reference	PAI Reference	Description
DDC A0259975047	636031	Rear Crankshaft Seal (4.5in ID x 5.5in OD x .48in Wide)
Application: Detroit Diesel Multiple		



OEM Reference	PAI Reference	Description
DDC A4722000115	681832OEM	Thermostat(188 Degrees)
Application: Detroit Diesel DD15		



OEM Reference	PAI Reference	Description
NAV 1841779C3	441417	Oil Cooler(32 Plates)
Application: International DT-466E / DT-570 (2004 & Up)		



OEM Reference	PAI Reference	Description
MAK 21122541	841350OEM	Crankcase Oil Separator
Application: Mack MP8 / Volvo D13		

Sensors Engine Drivetrain Cab & Chassis Air & Electrical



STAY CURRENT

WORLD TESTED. PERFORMANCE PROVEN.



Front View

Rear View

OEM Reference	PAI Reference	Description
MAK 22190294	860046OEM	Gear Cover Plate
Application: Mack MP8		



OEM Reference	PAI Reference	Description
MAK 85140248	831120	Turbocharger Mounting Kit Includes: Clamp (1)842022 Sealing Rings (2)821075 (1)836014 (1)831006 (1)831113 Washers (4)842052 (2)842041 Seals (1)821074 (1)136013 (2)836005 O-Rings (1)821081 (1)821009 Spacers (4)840054 Screws (4)840036 Gaskets (1)831116 (1)831005
Application: Mack MP8 / Volvo D13		

Air & Electrical

Cab & Chassis

Drivetrain

Engine

Sensors



STAY CURRENT

ISO:9001 CERTIFIED

New Engine Kits Available

OEM Reference	PAI Reference	Application
N/A	ISB631-257	Cummins ISB
CUM 4376429	ISX116-177	Cummins ISX
N/A	MV1340-001	Mack MP8 Volvo D13
N/A	DD1551-001 (w/o Piston)	Detroit Diesel DD15
DDC 23538418	S60117-017HP	Detroit Diesel Seris 60
N/A	466223-017	International DT466E HEUI
N/A	530131-001HP	International 530



STAY CURRENT

WORLD TESTED. PERFORMANCE PROVEN.

Additional New Items

PAI Reference	OEM Reference	Description
040097OEM	CUM 3944655	Screw
040152OEM	CUM 3680953	Screw
101125	N/A	Cylinder Kit
111622HP	CUM 4955365	HP Piston Kit
311073	N/A	Piston Pin
311073HP	N/A	HP Piston Pin
311308	N/A	Piston Kit
345028OEM	CAT 4N0684	Dowel Pin
410037HP	N/A	HP Piston Kit
431376	NAV 1882823C1	Sealing Ring
621259	DDC A4729970845	O-Ring
621284	DDC A0249973945	Liner Seal
621285	DDC A0239975545	Liner Seal
640062OEM	DDC 8929334	Woodruff Key
640065OEM	DDC A4710160069	Cylinder Head Bolt
640077OEM	DDC N000000005600	Dowel Pin
640094	DDC N000000001068	Washer
640135OEM	DDC A0019984450	Fuel Plug
642015OEM	DDC 23533911	Exhaust Manifold Seal
842042OEM	MAK 37AX68	Washer

STAY CURRENT

FEBRUARY 2021 EDITION

PA INDUSTRIES, INC.
STAY CURRENT



ISO 9001
CERTIFIED

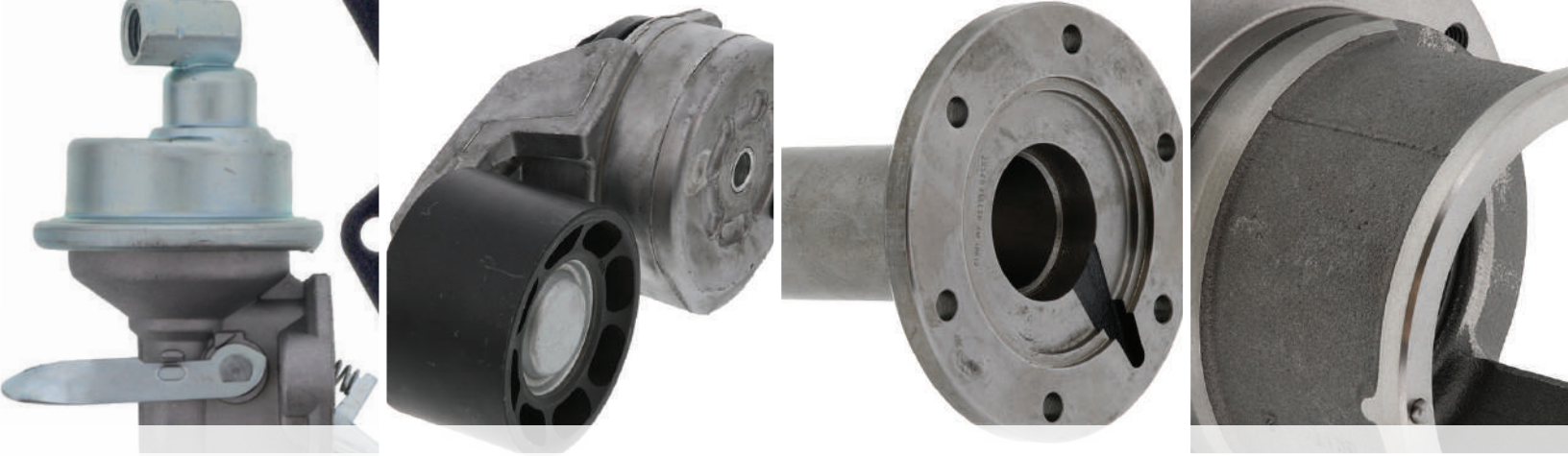

PAI MONTHLY NEWSLETTER - MARCH 2021 EDITION

STAY CURRENT



World Tested. Performance Proven.

MARCH 2021



STAY CURRENT

ISO:9001 CERTIFIED

Table of Contents

Price Reduced	2
Featured Item	3
Sensors	4-5
Drive Train Components	6
Engine Components	7-10
New Available Engine Kits	11
Additional New Items	12



STAY CURRENT

WORLD TESTED. PERFORMANCE PROVEN.

Price Reduced

PAI Reference	OEM Reference	Description
ENU-0411	MAK 189AM2	Nut
JUJ-6978	DAN SPL250X	U-Joint
040126	CUM 4891025	Screw
060167E	CUM 4374091	Cylinder Head
132054	CUM 2882046	Upper Gasket Kit
141296	CUM 4003950	Oil Pump
180224	CUM 3928161	Solenoid
181944	CUM 3049174	Water Tube
191839	CUM 3970366	Camshaft
191887	CUM 3283179	Camshaft
381802	CAT 1354925	Water Pump Assy.
390016	CAT 1225053	Solenoid Valve
681812E	DDC 23526039	Water Pump Assy.
681813E	DDC 23535017	Water Pump Assy.
841270	VOL 22995773	Housing Nipple
900142	FUL 4303357	Main Drive Gear
900393	FUL 4303596	Yoke Bar
340611-091HP	N/A	HP Engine Kit
C90103-001	N/A	Engine Kit
ISX113-017	CUM 4376175	Engine Kit
ISX119-022	N/A	Engine Kit
ISX119-033	N/A	Engine Kit
ISX119-034	N/A	Engine Kit
ISX119-065	CUM 4376178	Engine Kit
S60138-001	N/A	Engine Kit
ERK-8029-117	N/A	Engine Kit



STAY CURRENT

WORLD TESTED. PERFORMANCE PROVEN.

Featured Item: Mack Side Frame Step Kit

PAI's Mack Side Frame Step Kit are thoroughly tested to ensure optimum fit and performance on specific vehicle applications. This replacement Side Frame Step Kit fits Mack MR and MRU models.



Mack MR & MRU Models

OEM Recommended Specs

High-Grade Material

2-Year Warranty

PAI Reference	OEM Reference
803860	N/A
Material: Aluminum	Finish/Color: Silver
Dimensions (LxW): 21.375in x 7.187in	
Description: Side Frame Step Kit	
Application: Mack MR & MRU Models	



Not sold assembled.*



STAY CURRENT

WORLD TESTED. PERFORMANCE PROVEN.

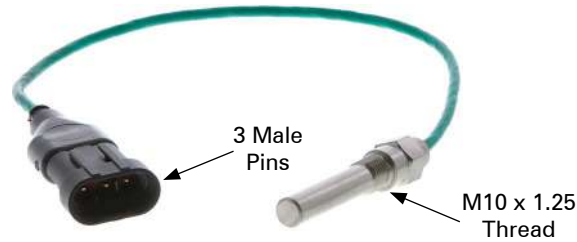

OEM Reference	PAI Reference	Description
MAK 64MT457M	845077	Turbocharger Speed Sensor (17.5in OAL)
Application: Mack MP8		



OEM Reference	PAI Reference	Description
NAV 4097728C91	450646OEM	DEF Level Sensor Includes Gaskets (2)
Application: International DT 466 / 530		

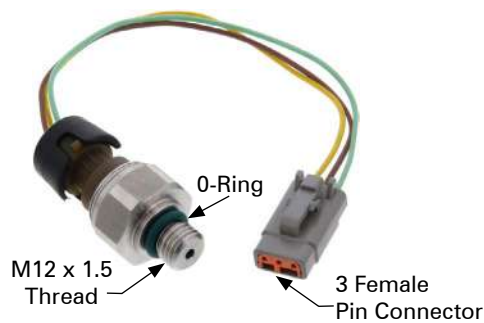

OEM Reference	PAI Reference	Description
NAV 1875784C93	450608E	Pressure Sensor Kit(6.75in OAL) Includes Sensor (1)450609E O-Ring (1)121289
Application: International Multiple		

Air & Electrical

Cab & Chassis

Drivetrain

Engine

Sensors



STAY CURRENT

ISO:9001 CERTIFIED



OEM Reference	PAI Reference	Description
FUL 20549	900419OEM	Front Bearing Cover (2in Push Input Shaft)
Application: Fuller Multiple		



OEM Reference	PAI Reference	Description
N/A	920025	Bearing & Seal Kit Includes Bearings (1)EE73280 (127484) (1)ER74900 (62AX413) (1)EM91220 (62AX157) (1)ER60200 (493) (1)ER71650 (29630) (1)EE74110 (5735) (1)ER71640 (29675) (1)BBG-7397-TIM (55212C) (1)ER71180 (72487) (1)EM71200 (552A) (1)EE73720 (62AX159) (1)EE74090 (72218C) (1)EE90610 (64AX72) Seals (1)EE72940 (128703) (1)EE72950 (127591) Washer (1)EE31310 (128702) O-Rings (2)EE29580 (127545) Retaining Ring (1)EE28270 (85997) Shim Kit (1)EE70910-400
Application: Eaton Pre 2008 DS 344 / 404 / 405 / 454		

Air & Electrical

Cab & Chassis

Drivetrain

Engine

Sensors



STAY CURRENT

WORLD TESTED. PERFORMANCE PROVEN.



OEM Reference	PAI Reference	Description
N/A	920026	Bearing & Seal Kit Includes Bearings (1)EE73280 (127484) (1)ER74900 (62AX413) (1)EM91220 (62AX157) (1)ER60200 (493) (1)920070 (132060) (1)EE74110 (5735) (1)BCU-7166 (110811) (1)BBG-7397-TIM (1)ER71180 (72487) (1)EM71200 (552A) (1)EE73720 (62AX159) (1)EE74090 (72218C) (1)EE90610 (64AX72) Seals (1)EE72940 (128703) (1)EE72950 (127591) Washer (1)EE31310 (128702) O-Rings (2)EE29580 (127545) Retaining Ring (1)EE28270 (85997) Shim Kit (1)EE70910-400
Application: Eaton After 2008 DS 344 / 404 / 405 / 454		

Air & Electrical Cab & Chassis Drivetrain Engine Sensors



OEM Reference	PAI Reference	Description
MAK 53KH3104	808105OEM	Retainer Housing Assembly Includes Cup (1) BCU-7170OEM
Application: Mack CRD 150 / 151		



STAY CURRENT

ISO:9001 CERTIFIED



OEM Reference	PAI Reference	Description
CUM 3082622	121090OEM	Oil Line Assembly
Application: Cummins N14 / 855		



OEM Reference	PAI Reference	Description
CUM 3882346	141326OEM	Oil Pan Transfer Tube
Application: Cummins ISM / M11		



OEM Reference	PAI Reference	Description
CUM 4101432	191938OEM	Injector Camshaft
Application: Cummins ISX		



OEM Reference	PAI Reference	Description
CUM 4937405	180137	Fuel Pump Assembly Includes Gaskets (2)131532
Application: Cummins 6B 5.9L		

Air & Electrical

Cab & Chassis

Drivetrain

Engine

Sensors



STAY CURRENT

WORLD TESTED. PERFORMANCE PROVEN.



OEM Reference	PAI Reference	Description
N/A	151571	Cylinder Head Rebuild Kit Includes Intake Valves (12)192145 (4965868) Exhaust Valves (12)192147 (4101454) Valve Guides (24)192126 (4026657) Valve Springs (24)192155 (3679551) Retainers (24)192103 (3680884) Injector Tubes (6)192123 (3412352) Sealing Rings (6)121353 (3678536) Valve Stem Seals (24)192161 (4356366) Valve Locks (48)492062 (1824644C1) Cam Bearing Kit (1)151557
Application: Cummins ISX		



OEM Reference	PAI Reference	Description
CAT 1663650	345010OEM	Piston Cooling Nozzle
Application: Caterpillar 3406E		



OEM Reference	PAI Reference	Description
CAT 4571056	331679	Front Cover Gasket Kit Includes O-Rings (1)321223 (2)321229 (1)321230 (1)321231 (1)321322 (2)321375 (1)321393 (1)321438 (2)321479 (1)121250 (1)EGA-3062 Gasket (1)331672 Seal (1)336046
Application: Caterpillar C7		

Air & Electrical
Cab & Chassis
Drivetrain
Engine

Sensors



STAY CURRENT

ISO:9001 CERTIFIED



OEM Reference	PAI Reference	Description
DDC A4712030780	631414OEM	Rear EGR Gasket(Edge Molded)
Application: Detroit Diesel DD13		



OEM Reference	PAI Reference	Description
NAV 3508604C91	480889	Belt Tensioner
Application: Detrpoit Diesel 60 Series		



OEM Reference	PAI Reference	Description
NAV 1842127C95	441416	Oil Cooler Kit(32 Plates) Includes Oil Cooler (1)441417 Gasket Kit (1)431307 Bolts (8)440014
Application: International DT-466E / DT-570 (2004 & Up)		

Air & Electrical

Cab & Chassis

Drivetrain

Engine

Sensors



STAY CURRENT

WORLD TESTED. PERFORMANCE PROVEN.



OEM Reference	PAI Reference	Description
NAV 1836542C1	431371OEM	Intake Gasket
Application: International 7.3 / 444		



OEM Reference	PAI Reference	Description
N/A	805064	Exhaust Manifold Kit Includes Manifolds (1) EEX-1848 (104GC5165AM3) (2)EEX-2054 (104GC5164M) Nuts (12)ENU-0411 (189AM2) (4)ENU-0406 (142GC247M) Gaskets (6)EGK-3934 (57GB257A) (1)EGS-3890-020 (590GB1189A) Studs (12)EST-0421 (616GC245M3) (4)EST-0417 (616GC228M) Washers (4)EWA-0337 (271AM5009)
Application: Mack E7		



OEM Reference	PAI Reference	Description
MAK 715GB3135A	841215OEM	Dipstick Guide
Application: Mack / Volvo Multiple		

Air & Electrical Cab & Chassis Drivetrain Engine Sensors



STAY CURRENT

ISO:9001 CERTIFIED

New Engine Kits Available

OEM Reference	PAI Reference	Application
N/A	C12101-049	Caterpillar C12
MAK 85132406	ERK-8046-017	Mack ASET
N/A	MV1302-001	Mack MP8 / Volvo D13



STAY CURRENT

WORLD TESTED. PERFORMANCE PROVEN.

Additional New Items

PAI Reference	OEM Reference	Description
040146OEM	CUM 3930249	Screw
050588	N/A	Plug Kit
101205	N/A	Cylinder Kit
111295HP	CUM 3925878	HP Piston
111764	N/A	Piston Kit
111768	CUM 4376243	Piston Kit
111784	MAH 929969335-020	Piston
111784HP	MAH 929969335-020	HP Piston
111785HP	MAH 929969336	HP Piston Kit
141334OEM	CUM 3030803	Oil Cooler Spring
141338OEM	CUM 3039296	Oil Cooler Spring
172048OEM	CUM 4376360	Rod Bearing
180292OEM	CUM 3062157	Tube Clamp
340122OEM	CAT 3049553	Stud
440053OEM	NAV 7094780C1	Capscrew
605070HP	DDC 23537529	HP Ring Set
900236OEM	FUL 21652	Drive Pin

STAY CURRENT

MARCH 2021 EDITION

PA INDUSTRIES, INC.
STAY CURRENT



ISO 9001
CERTIFIED



PAI MONTHLY NEWSLETTER - APRIL 2021 EDITION

STAY CURRENT



World Tested. Performance Proven.

APRIL 2021



STAY CURRENT

ISO:9001 CERTIFIED

Table of Contents

Price Reduced	2-3
Featured Item	4
Now Available in Excel Components	5
Drive Train Components	6
Engine Components	7-10
New Available Engine Kits	11
Additional New Items	12



STAY CURRENT

WORLD TESTED. PERFORMANCE PROVEN.

Price Reduced

PAI Reference	OEM Reference	Description	PAI Reference	OEM Reference	Description
FAS-0668	GDY 2B12-300	Air Spring	ISM102-018	N/A	Engine Kit
FAS-0673	GDY 2B12-410	Air Spring	ISM102-021	N/A	Engine Kit
EGS-3905	MAK 126SB186	Gasket Kit	ISM102-022	N/A	Engine Kit
FUB-4772	MAK 7QK3154P5	U-Bolt Kit	ISM102-023	N/A	Engine Kit
HBG-4780	MAK 62AX45	Cone	ISM102-026	N/A	Engine Kit
KCU-4814	MAK 9383-HM518410	Cup	ISM102-030	N/A	Engine Kit
HBG-4817	MAK 62AX486	Cone	ISM102-031	N/A	Engine Kit
HCM-4941	MAK 235-2210W5639S	Brake Camshaft	ISX105-017	N/A	Engine Kit
HBS-5412	NTN SET68	Cup & Cone Set	ISX105-022	N/A	Engine Kit
HBS-5421	NTN SET401	Cup & Cone Set	ISX105-033	N/A	Engine Kit
LRV-5617	MAK 20QE410	Relay Valve	ISX105-049	N/A	Engine Kit
BBG-7402	MAK 62AX192	Cone	ISX105-065	N/A	Engine Kit
BBG-7433	MAK 62AX358	Cone	ISX105-065HP	N/A	HP Engine Kit
BBG-7473	MAK 62AX396	Cone	ISX105-081	N/A	Engine Kit
BCU-7637	MAK 2719-51232	Cup	ISX105-097	N/A	Engine Kit
HBG-9065	MAK 62AX290	Cone	ISX105-161	N/A	Engine Kit
HBG-9129	MAK 62AX478	Cone	ISX106-017	N/A	Engine Kit
EM43560	LNV 79011	Rotor	ISX106-017HP	N/A	HP Engine Kit
EM50480	MID 40010216	Slack Adjuster	ISX106-018	N/A	Engine Kit
050731	CUM 4954574	Sensor	ISX106-018HP	N/A	HP Engine Kit
141450	CUM 4955421	EGR Valve Kit	ISX106-022	N/A	Engine Kit
350567	CAT 3341387	Sensor	ISX106-026	N/A	Engine Kit
350594	CAT 1946723	Sensor	ISX106-027	N/A	Engine Kit
660005E	DDC 23525566	Cylinder Head Assy.	ISX106-081	CUM 4352289	Engine Kit
755168	HDK C-23086-2	Strap Kit	ISX106-145	CUM 4352392	Engine Kit
806994	NTN 385A	Cone	ISX106-145HP	N/A	HP Engine Kit
808103	MAK 36KN428	Pinion Housing	ISX107-017	N/A	Engine Kit
845077	MAK 64MT457M	Sensor	ISX107-017HP	N/A	HP Engine Kit
900069HP	FUL 4303121	HP Gear	ISX107-019	N/A	Engine Kit
920070	EAT 132060	Cone	ISX107-022	N/A	Engine Kit
ISM102-017	CUM 4918787	Engine Kit	ISX107-023	N/A	Engine Kit
ISM102-017HP	N/A	HP Engine Kit	ISX107-027	N/A	Engine Kit



STAY CURRENT

ISO:9001 CERTIFIED

Price Reduced

PAI Reference	OEM Reference	Description
ISX107-049	N/A	Engine Kit
ISX107-053	N/A	Engine Kit
ISX107-081	CUM 4352290	Engine Kit
ISX107-081HP	CUM 4352290	HP Engine Kit
ISX107-113	N/A	Engine Kit
ISX141-081	N/A	Engine Kit
ISX141-097	N/A	Engine Kit
ISX141-113	N/A	Engine Kit
ISX141-273	N/A	Engine Kit
ISX141-289	N/A	Engine Kit
ISX141-305	N/A	Engine Kit
ISX141-321	N/A	Engine Kit
S60141-065	N/A	Engine Kit
S60141-081	N/A	Engine Kit
S60141-113	N/A	Engine Kit



STAY CURRENT

WORLD TESTED. PERFORMANCE PROVEN.

Featured Item: Caterpillar C7 Engine Oil Pan

PAI's Oil Pans are thoroughly tested to ensure optimum fit and performance on specific vehicle applications. This replacement Oil Pan fits Caterpillar C7 engines, replaces OE 1753232.



FREE Oil Pan Gasket Included*

Plugs & Hardware Included

Ensures Optimum Fit and Performance

Direct Replacement for Caterpillar 1753232

OEM Recommended Specs

High-Grade Material

PAI Reference	OEM Reference
341376	CAT 1753232
Pan Gasket #: 331337	CAT 1662905
Drain Plugs#: 342153	CAT 1682288
Description: Oil Pan (Front/Rear Sump)	
Application: Caterpillar C7 Engine	
Material : Steel	

Customer ESN required to confirm components.

*Free Oil Pan Gasket included only for select PAI Oil Pans.



STAY CURRENT

ISO:9001 CERTIFIED

Now Available in Excel



OEM Reference	PAI Reference	Description
CUM 4962732	060163E	Cylinder Head Assembly(Loaded) Includes Cylinder Head (1) Retainers (24)192103 Intake Valves (12)192145HP Exhaust Valves (12)192147HP Valve Springs (24)192155 Valve Seals (24)192161 Valve Locks (48)492062
Application: Cummins ISX		



OEM Reference	PAI Reference	Description
NAV 1686649C91	451432E	Power Steering Pump
Application: International Multiple		



STAY CURRENT

WORLD TESTED. PERFORMANCE PROVEN.



OEM Reference	PAI Reference	Description
MAK 21130954	808158OEM	Gear Set(3.11 / 3.25 Ratio) (42 Spline Teeth) (19 Pinion Gear Teeth) (21 Ring Gear Teeth)
Application: Mack CRD 150 Front Differential / CRD 151 Rear Differential		



OEM Reference	PAI Reference	Description
MAK 181MU51P22	808010OEM	Half Round Yoke w/ Speedometer Gear (Series 1810) (2.374in Spline Diameter) (46 Internal Spline Teeth) (16 External Spline Teeth)
Application: Mack Multiple		



STAY CURRENT

ISO:9001 CERTIFIED



OEM Reference	PAI Reference	Description
CAT 1878981	371631OEM	Crankshaft Gear(80 Teeth)
Application: Caterpillar C15		



OEM Reference	PAI Reference	Description
CUM 3686962	192177	Fuel Injector Sleeve Kit Includes Sleeve (1)192176 Sealing Ring (1)121409
Application: Cummins ISX		



Inside



Outside

OEM Reference	PAI Reference	Description
CUM 3975179	060015	Flywheel Housing
Application: Cummins 4B / 6B / ISB / QSB		

Air & Electrical

Cab & Chassis

Drivetrain

Engine

Sensors



STAY CURRENT

WORLD TESTED. PERFORMANCE PROVEN.



OEM Reference	PAI Reference	Description
CUM 4965487	141431OEM	Oil Cooler Core
Application: Cummins QSX		



OEM Reference	PAI Reference	Description
CUM 5473171	181977OEM	Water Pump Kit Includes Water Pump (1)181976OEM O-Ring (1)121258OEM
Application: Cummins 6B 5.9L / ISB		



OEM Reference	PAI Reference	Description
DDC R23539301	641315OEM	EGR Valve
Application: Detroit Diesel Series 60		

Air & Electrical

Cab & Chassis

Drivetrain

Engine

Sensors



STAY CURRENT

ISO:9001 CERTIFIED



OEM Reference	PAI Reference	Description
DDC 23524520	641340OEM	Oil Cooler Thermostat
Application: Detroit Diesel Series 60		

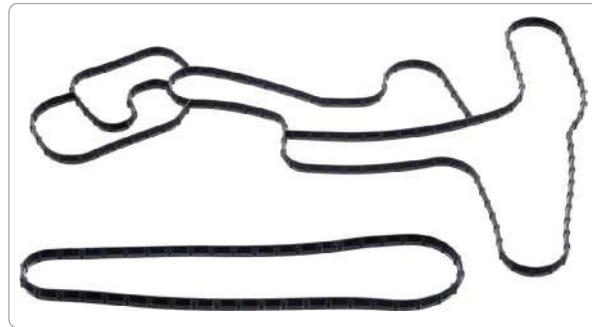

OEM Reference	PAI Reference	Description
NAV 1889121C93	431385OEM	Heat Exchanger Gasket Kit Includes Collar Gasket (1)431383OEM Housing Gasket (1)431384OEM
Application: International Multiple		



OEM Reference	PAI Reference	Description
MAK 57MD31A	FAF-4561OEM	Engine Air Filter
Application: Mack Multiple		



STAY CURRENT

WORLD TESTED. PERFORMANCE PROVEN.

Air & Electrical



OEM Reference	PAI Reference	Description
MAK 203GC4383M	EFL-2467OEM	Fuel Tube
Application: Mack E-Tech / ASET		

Cab & Chassis



OEM Reference	PAI Reference	Description
MAK 691GC49M	841981OEM	VGT Valve (3 Pin Male Connector) (Ports M12 x 1.5)
Application: Mack ASET		

Drivetrain



OEM Reference	PAI Reference	Description
MAK 22992289	860047OEM	Timing Gear Cover
Application: Mack MP8 / Volvo D13		

Engine

Sensors



OEM Reference	PAI Reference	Description
VOL 22539850	841982OEM	Exhaust Brake Solenoid Valve (12V)
Application: Mack / Volvo Multiple		



STAY CURRENT

ISO:9001 CERTIFIED

New Engine Kits Available

OEM Reference	PAI Reference	Application
N/A	C12601-081	Caterpillar C12
N/A	C16601-010HP	Caterpillar C16
N/A	ISB607-101HP	Cummins ISB
N/A	ISB621-026HP	Cummins ISB
CUM 4352287	ISX110-097	Cummins ISX
CUM 4376171	ISX116-161	Cummins ISX
MAK 85138502	MV1303-001	Mack MP8 / MD13 Volvo D13
N/A	S60114-001HP	Detroit Diesel Series 60



STAY CURRENT

WORLD TESTED. PERFORMANCE PROVEN.

Additional New Items

PAI Reference	OEM Reference	Description
PSB-1003OEM	MAK 1940-H4651	Headlight
040077OEM	CUM 3936683	Screw
040079OEM	CUM 3936685	Screw
040147OEM	CUM 3103086	Screw
045159	N/A	Pressure Relief Ball
040159OEM	CUM 3678882	Bolt
040162	CUM 3025806	Screw
050547OEM	CUM 129859	Elbow Fitting
050585	CUM 3680534	O-Ring Plug
111423HP	N/A	HP Piston Kit
321492	CAT 1121102	O-Ring
321498	CAT 2N3350	O-Ring
340006OEM	CAT 1383252	Screw
340030OEM	CAT 8T5030	Screw
340125OEM	CAT 1B8705	Key
421245	NAV 1837799C1	O-Ring
440051OEM	NAV 7094783C1	Screw
505070HP	CUM 4089810	HP Ring Set
605088	DDC A4710300424	Piston Ring Set
631362OEM	DDC 23535457	Turbo Gasket
691953OEM	DDC A4720530026	Valve Lock

STAY CURRENT

APRIL 2021 EDITION

PA INDUSTRIES, INC.
STAY CURRENT



ISO 9001
CERTIFIED



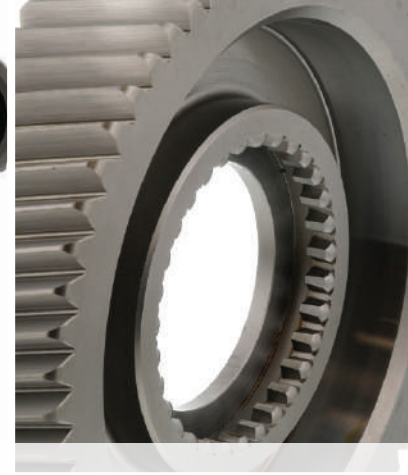

PAI MONTHLY NEWSLETTER - MAY 2021 EDITION

STAY CURRENT



World Tested. Performance Proven.

MAY 2021



STAY CURRENT

ISO:9001 CERTIFIED

Table of Contents

Price Reduced	2
Featured Item	3
Sensors	4
Now Available in Excel Components	5
Air & Electrical / Cab & Chassis Components	6
Drive Train Components	7-8
Engine Components	9-10
New Available Engine Kits	11
Additional New Items	12



STAY CURRENT

WORLD TESTED. PERFORMANCE PROVEN.

Price Reduced

PAI Reference	OEM Reference	Description
FAS-0599	GDY 2B9-254	Air Spring
FAS-0669	GDY 1R12-620	Air Spring
FAS-0725	GDY 1R11-150	Air Spring
FAS-0727	GDY 1R12-400	Air Spring
FAS-0747	GDY 1R14-030	Air Spring
FAS-0749	GDY 1R12-355	Air Spring
FAS-0752	GDY 1R12-424	Air Spring
FAS-0761	GDY 1R12-256	Air Spring
DCC-1041X-BEN	BEN 286554	Compressor
EET-1888	MAK 4ME32537	Exhaust Pipe
HKT-3403	MAK 6990-TAS000001	Steering Box Kit
MST-5355	LNV 77792	Stator
EDG-8869	MAK 715GB331	Guide
EM38140	VIC V10NF1S5T38C5H	Power Steering Pump
040077	CUM 3936683	Screw
040160	CUM 3680817	Camshaft Bolt
045057	CUM 3919449	Pin
050621	CUM 4032806	Sensor Kit
131564	CUM 3804276	Upper Gasket Set
181179	CUM 4955833	Turbocharger
340006	CAT 1383252	Cylinder Head Bolt
381810E	CAT 1727760	Water Pump Assy.
441211	NAV 1881751C93	Oil Pump
441211OEM	NAV 1881751C93	Oil Pump
750076	HDK 66649-005L	Bushing
750217	HDK 50181-004	Spring Hanger
750242	HDK 60216-000	Torque Rod Kit
750316	HDK 60961-009	King Pin Kit
750470	HDK 10372-000	Hanger Tube
750581	HDK 25102-000	Sleeve
755040	HDK S-24680	Bolt Kit
755157	HDK S-25512	Shock Absorber

PAI Reference	OEM Reference	Description
804335	GDY 1R12-188	Air Spring
ISX107-086	CUM 4352290	Engine Kit



STAY CURRENT

WORLD TESTED. PERFORMANCE PROVEN.

Caterpillar® Oil Pans

PAI now offers an All New Aluminum Oil Pan that meets or exceeds OEM quality. Made with State-of-the-Art High Pressure Die Casting technology.



Aluminum Caterpillar Oil Pan | (Front/Rear Sump)

PAI Ref.	OEM Ref.	Description
341370	CAT 7C3236	Oil Pan Kit

Application: 3406B, 3406C, 3406E

GASKET & HARDWARE INCLUDED*

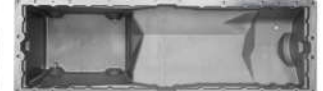

Aluminum Caterpillar Oil Pan | (Front/Rear Sump)

PAI Ref.	OEM Ref.	Description
341371	CAT 1601428	Oil Pan Kit

Application: 3406E / C15 / C16 / C18 : Deep Oil Pan

GASKET & HARDWARE INCLUDED*

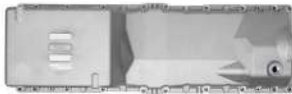

Aluminum Caterpillar Oil Pan | (Rear Sump)

PAI Ref.	OEM Ref.	Description
341372	CAT 2273006	Oil Pan Kit

Application: C15, ACERT

GASKET & HARDWARE INCLUDED*

Stronger, Lighter Oil Pan	High Pressure Die Casting for Longer Life
Even Wall Thickness	High Precision CNC Machining
Superior Finish	Drain Plugs Are Included

*Free Oil Pan Gasket & Hardware included only for select PAI Oil Pan Kits.



STAY CURRENT

WORLD TESTED. PERFORMANCE PROVEN.

Air & Electrical

Cab & Chassis

Drivetrain

Engine

Sensors



OEM Reference	PAI Reference	Description
CUM 5550064	050613	Speed Sensor Kit(27in OAL) Includes Sensor (1)050612 w/ O-Ring (1)121316 Screw (1)040077 Harness Clips (2)121130
Application: Cummins Multiple		



OEM Reference	PAI Reference	Description
NAV 1881015C92	450613	Intake Manifold Sensor Kit (2.52in OAL) Includes Sensor (1)450614 O-Ring (1)121289
Application: International Multiple		



OEM Reference	PAI Reference	Description
NAV 2005190C1	451343	Low Coolant Level Sensor (3.32in OAL)
Application: International Multiple		



STAY CURRENT

ISO:9001 CERTIFIED

Now Available in Excel



OEM Reference	PAI Reference	Description
CAT 2592400	381212E	Turbocharger Includes Gaskets and Stud
Application: Caterpillar C13		



OEM Reference	PAI Reference	Description
CUM 3915703	141284E	Oil Pan(Front/Rear Sump) Includes Hardware
Application: Cummins 6B 5.9L		



OEM Reference	PAI Reference	Description
KEN Q21-6005	730410E	Speed Sensor(12.95in OAL)
Application: Kenworth Multiple		



STAY CURRENT

WORLD TESTED. PERFORMANCE PROVEN.



3 Position Switch

Front



12 Male Pins

Back

OEM Reference	PAI Reference	Description
MAK 1MR4355M3	853769	Light Switch
Application: Mack GU		



OEM Reference	PAI Reference	Description
MAK 8846-032195	802528	Suspension Dump Valve (1)1/8in Supply Port (1)1/8in Pilot Port (2)1/8in Delivery Ports
Application: Multiple		



OEM Reference	PAI Reference	Description
MAK 3543-H9631	803710OEM	Heater Motor
Application: Mack CXN / CXU / GU		

Air & Electrical

Cab & Chassis

Drivetrain

Engine

Sensors



STAY CURRENT

ISO:9001 CERTIFIED



OEM Reference	PAI Reference	Description
DAN 139965	960255	Interaxle Differential Assembly
Application: Dana D170 Differential		



OEM Reference	PAI Reference	Description
DAN 513889	960269	Gear Set(4.10 Ratio) Pinion Gear 10 Teeth Ring Gear 41 Teeth
Application: Dana D170 Differential		



OEM Reference	PAI Reference	Description
DAN 513890	960270	Gear Set(4.30 Ratio) Pinion Gear 10 Teeth Ring Gear 43 Teeth
Application: Dana D170 Differential		



STAY CURRENT

WORLD TESTED. PERFORMANCE PROVEN.



OEM Reference	PAI Reference	Description
FUL 4302413	900691	Auxiliary Mainshaft Gear
Application: Fuller 14210B / 15210B		



OEM Reference	PAI Reference	Description
FUL 4302420	900074HP-010	HP Countershaft Gear(2nd) (10 pc. Bulk Packaging)
Application: Fuller FR/FRO 14210 / 15210 / 16210 / 18210		

Air & Electrical

Cab & Chassis

Drivetrain

Engine

Sensors



STAY CURRENT

ISO:9001 CERTIFIED



OEM Reference	PAI Reference	Description
CUM 4955850	105001OEM	Spark Plug Kit Includes Spark Plug (1)105002OEM Boot (1)105003OEM
Application: Cummins 6CTA Natural Gas and ISL Natural Gas		



OEM Reference	PAI Reference	Description
DDC A4710160720	631404	Cylinder Head Gasket
Application: Detroit Diesel DD13		



OEM Reference	PAI Reference	Description
DDC A4712030680	631413	EGR Gasket
Application: Detroit Diesel DD13		



OEM Reference	PAI Reference	Description
NAV 1878629C95	480066	IPR Valve Kit Includes IPR Valve (1)480065 Connector Seal (1)436018
Application: International DT570 and DT466 HEUI		



STAY CURRENT

WORLD TESTED. PERFORMANCE PROVEN.



OEM Reference	PAI Reference	Description
MAK 21457952	891949	Fuel Injector Assembly
Application: Mack MP7 / Volvo D11		



OEM Reference	PAI Reference	Description
MAK 22027808	891948X	Fuel Injector Assembly(Reman)
Application: Mack MP8 / Volvo D13		



OEM Reference	PAI Reference	Description
MAK 795GB363AP7	EDS-8876OEM	Dipstick(24-5/8in OAL)
Application: Mack Multiple		

Air & Electrical

Cab & Chassis

Drivetrain

Engine

Sensors



STAY CURRENT

ISO:9001 CERTIFIED

New Engine Kits Available

OEM Reference	PAI Reference	Application
CUM 4376172	ISX117-113	Cummins ISX
N/A	ISX119-049	Cummins ISX
N/A	ISX141-113(w/o Piston)	Cummins ISX



STAY CURRENT

WORLD TESTED. PERFORMANCE PROVEN.

Additional New Items

PAI Reference	OEM Reference	Description
JSC-0309OEM	DAN 12-73-125M	Screw
040156OEM	CUM 3939409	Connecting Rod Bolt
040159OEM	CUM 3678882	Camshaft Bolt
111662	CUM 4376499	Piston/Ring Kit
136172	CUM 3803615	Fuel Pump Seal
141308OEM	CUM 3030806	Bypass Plunger
141327OEM	CUM 4082897	Transfer Tube
141359	N/A	Spring
141360	N/A	Spring
340035OEM	CAT 5F4899	Screw
371613OEM	CAT 2239150	Connecting Rod
391855	CAT 3003565	Valve Insert
391969	CAT 4644668	Exhaust Valve
631411	DDC A4711420180	Gasket
631412	DDC A4711420280	Gasket
631413	DDC A4712030680	Gasket
631415	DDC A4710960380	Gasket
631416	DDC A4710160521	Gasket
631417	DDC A4721420880	Gasket
631419	DDC A0000910860	Gasket
671525	DDC A4710300545	Thrust Bearing Set
671530	DDC A4710300140	Main Bearing
671545	DDC A4710300860	Rod Bearing
671555	N/A	Rod Bearing Kit
730321OEM	PAC 1982821PE	Drain Plug
960234	DAN 132439	Thrust Washer

STAY CURRENT

MAY 2021 EDITION

PA INDUSTRIES, INC.
STAY CURRENT



ISO 9001
CERTIFIED

Buy quality replacement transmission parts in our online store.