



04--CURRENT F-150 6 1/2' & 8' BOX BOARDS

DRILLING INTO BODY AND FRAME IS REQUIRED.

INSTALLATION PARTS LIST:	QTY.6'/8'	DESCRIPTION	QTY.6'/8'	DESCRIPTION
	1	RUNNING BOARD 1 DRIVER & 1 PASSENGER	2/4	5/16" CLIP NUT
	1	STONE GUARD 1 LEFT & 1 RIGHT	10/24	5/16"x 3/4" BOLT
	8	3/8"x1 SELF TAPPING SCREW	18/20	5/16-18 HEX WASHER HEAD NUT
	6	#14x3/4" SHEET METAL SCREW	2/4	FLAT BRACKET, FL74
	4/8	1/4x5/8" SQUARE HEAD SCREW	2/4	FLAT BRACKET, FL73 D&P
	4/8	1/4-20 HEX NUT	2/4	HORIZONTAL BRACKET, SUPPORT, 3124F
	1	END CAP 1 LEFT & 1 RIGHT	2/4	#14 X 3/4 TEK SCREW
			0/2	BENT TAB BT32

TOOLS REQUIRED: 5/16" DRILL * 1/2" HEX SOCKET * 1/2" WRENCH * 5/16" NUT DRIVER * 3/8" NUT DRIVER

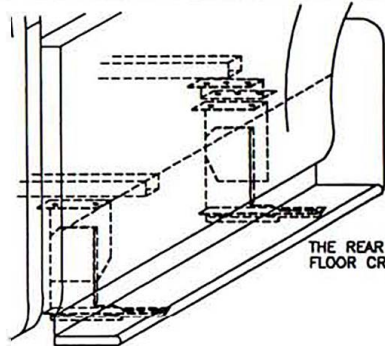

THE REAR BRACKET FITS ON THE SECOND FLOOR CROSS BRACE, 8' BEDS ONLY

BOX BRACKET LOCATION (DRIVERS SIDE SHOWN)

1 LOCATE THE FIRST BED CROSS BRACE BEHIND THE CAB, FOR 6 1/2' AND 8' BEDS

2 BRACKET ASSEMBLY ASSEMBLE WITH 5/16" BOLTS

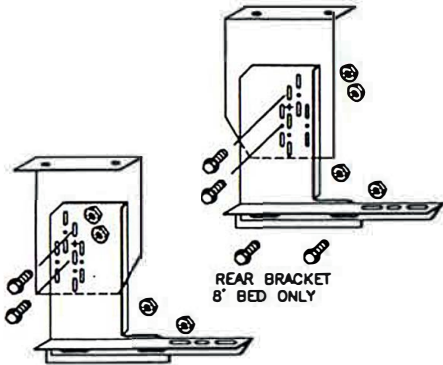

FRONT BRACKET 6 1/2' AND 8' BED'S

3 6 1/2' AND 8' BEDS. FRONT BRACKET PREDRILL A 5/16" HOLE NEAR THE END OF THE CROSSBRACE. SLIDE NUT CLIP INTO END OF CROSS BRACE

ASSEMBLE WITH 5/16" BOLTS AND NUT CLIP AND #14 SELF DRILLING SCREW

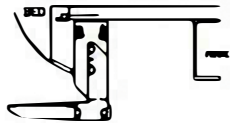

8' BED. REAR BRACKET

PREDRILL A 5/16" HOLE NEAR THE END OF THE CROSSBRACE. SLIDE NUT CLIP INTO END OF CROSS BRACE

ASSEMBLE BT32 TO CROSS BRACE WITH 5/16" BOLT AND NUT CLIP AND #14 SELF DRILLING SCREW ASSEMBLE FL73 AND FL74 TO CROSS BRACE WITH 5/16" BOLTS AND NUTS

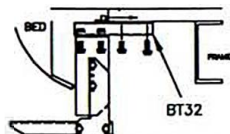

4 BEND STONE GUARD BY HAND AND KNEE TO FIT THE WHEEL WELL BEFORE INSTALLING TO RUNNING BOARD



5 FASTEN REAR STONE GUARD TO BOARDS WITH 3/8" SELF TAPPING BOLT. BEND STONE GUARD BY HAND AND KNEE TO FIT THE WHEEL WELL

7 INSTALL END CAP TO BOARD WITH 3/8" SELF TAPPING BOLT



6 SLIDE ONE 1/4"x5/8" SQUARE HEAD SCREW INTO EACH TRACK, 6 1/2' BED SLIDE TWO 1/4"x5/8" SQUARE HEAD SCREWS INTO EACH TRACK, 8' BED



8 HOLD BOARD IN PLACE, WITH THE FRONT RESTING ON THE BOX BRACKET NOTE: BE SURE THAT 1/4" BOLTS ARE PLACED INTO THE BRACKET STEP SUPPORT

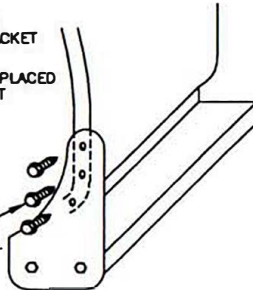

9 SCREW THROUGH STONE GUARD INTO FENDERWELL LIP USING #14 BY 3/4 SHEET METAL SCREWS, MAKE SURE YOU DRILL INTO METAL. 3 PLACES AT EACH STONE GUARD



11 WITH BOARD LEVEL TIGHTEN ALL LOOSE BOLTS

6 1/2' AND 8' BEDS. FRONT BRACKET

10 SECURE BOARD TO BRACKET WITH (2) 1/4" NUTS AT EACH BRACKET

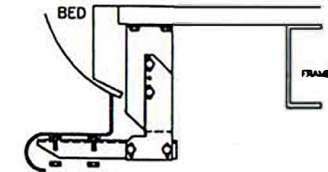

6 1/2' BED. REAR BRACKET

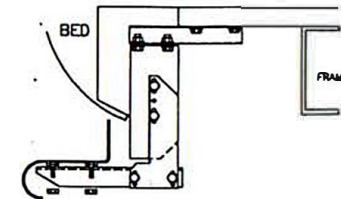

12 REPEAT FOR OTHER SIDE