

# USER MANUAL & REPLACEMENT PARTS LIST



# Safety Precautions



**WARNING:** The following safety precautions must be carefully observed to reduce the risk of fire and personal injury.

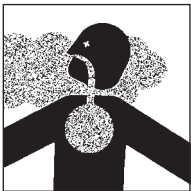
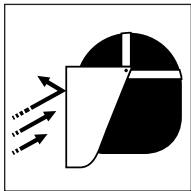
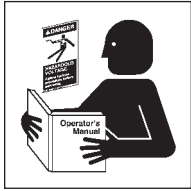

- Read and understand all the following safety precautions. If the operator cannot read these instructions, operating instructions and safety precautions must be read and discussed in the operator's native language.
- Operator of the OTC 7649A Fuel Injector Cleaner and bystanders must wear face shields.
- OTC 7649A and OTC 7000A are designed for use on gasoline engines ONLY. Do not use tool for diesel applications.
- Inspect the hose for damage before using the OTC 7649A Fuel Injector Cleaner and replace if needed.
- Check inside the hose to confirm there is no blockage.
- Do not exceed 100 psi maximum hose pressure.
- Use the OTC 7649A Fuel Injector Cleaner in a well ventilated areas.
- Observe normal precautions for working with flammable liquids: no smoking, open flames, electrical sparks, etc. Pressurized liquid and accumulated fumes can ignite. Have a Class B fire extinguisher available while working on fuel injection systems.
- Use the vehicle manufacturer's recommended procedures to service injectors. Never exceed the vehicle manufacturer's recommended pressures.
  - ❑ Release fuel system pressure before servicing fuel system components.
  - ❑ Wrap a shop towel around pressure tap fittings when connecting or disconnecting adapters to / from the vehicle and when disassembling the canister after use.
  - ❑ Tighten all connections; fuel leakage could cause a fire.
  - ❑ Do not modify any components of the OTC 7649A.
  - ❑ Do not replace any components of the OTC 7649A except those specified by OTC.
  - ❑ Keep hoses away from moving engine parts, hot engine components, and battery terminals.
  - ❑ Replace injector o-rings whenever injectors are removed.

# Parts List

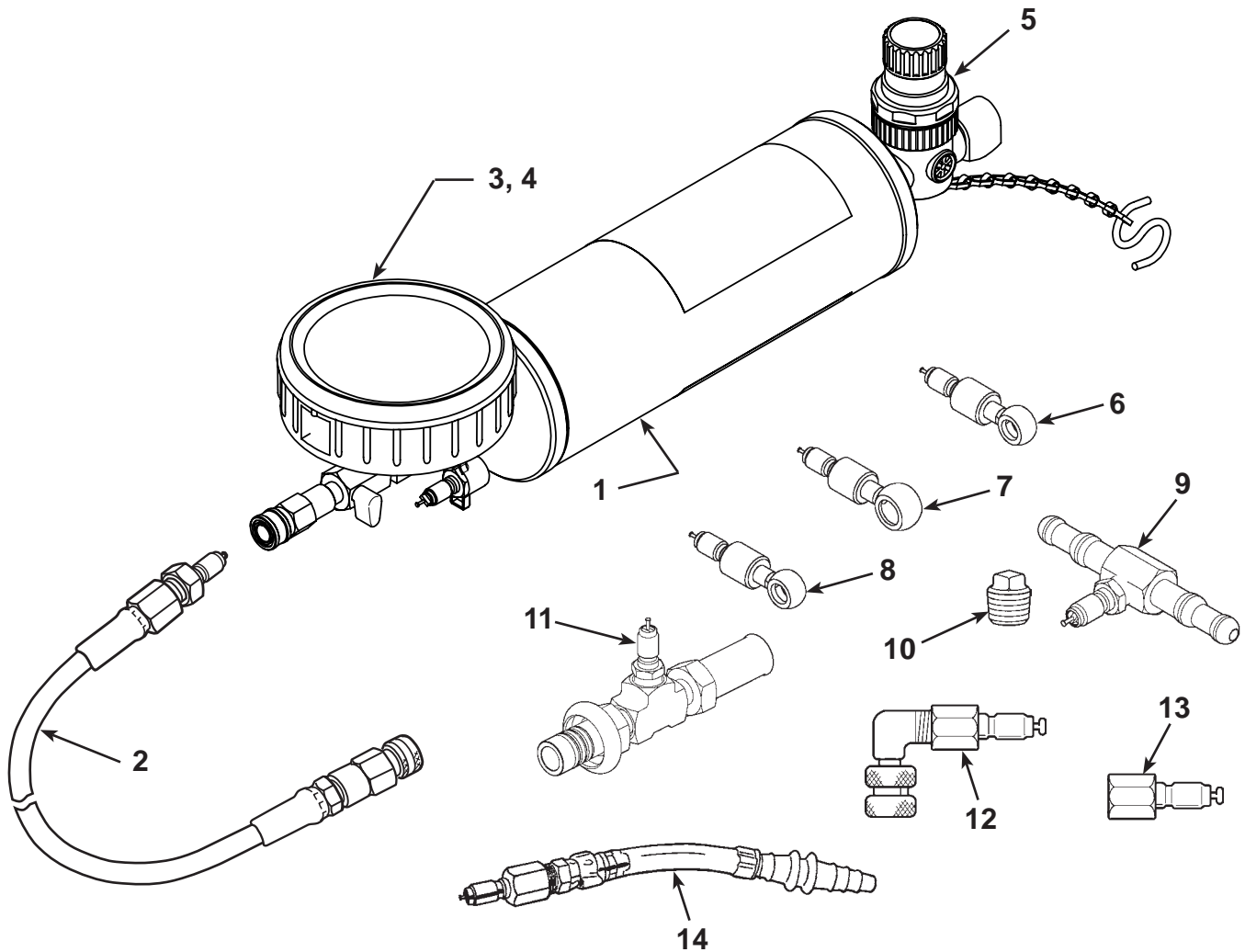

Item No.	Part No.	Qty.	Description
1	567710	1	Fuel Injector Cleaner Canister
2	581340	1	Hose (1/8 NPTF x 6' Lg.) w/ connectors
3	517145	1	Rubber Gauge Cover
4	313575	1	Pressure Gauge (0-100 PSI / 0-7 BAR)
5	213299	1	Air Regulator
6	314642	1	Special Banjo Fitting (8 mm)
7	314651	1	Special Banjo Fitting (10 mm)
8	314652	1	Special Banjo Fitting (12 mm)
9	518480	1	Chrysler TBI Fuel Pressure Adapter
10	11048	1	Pipe Plug (used with Item 11)
11	518499	1	Ford EFI Fuel Pressure Adapter
12	215285	1	Ford EFI Adapter w/Schrader Valve
13	440511	1	Special Disconnect Elbow Fitting
14	7666	1	Decarbonizing Adapter

**Parts Included but Not Shown**

6550MAN-13	1	Fuel Injection Application Manual
------------	---	-----------------------------------

# Cleaning Fuel Injectors

1. Read, understand, and follow the *Safety Precautions* on the previous page before using the Fuel Injector Cleaner.
2. Run the engine until it reaches normal operating temperature.
3. Shut OFF the engine. Turn OFF all accessories.
4. Disable the fuel pump. *Note: It is best to unplug the fuel pump at the fuel tank. On some vehicles, pulling the fuel pump fuse also disables the ignition system or fuel injectors.*
5. Turn OFF the shut-off valve at the bottom of the Fuel Injector Cleaner container. See Figure 1. *Note: Valve is OFF if it is turned all the way clockwise.*

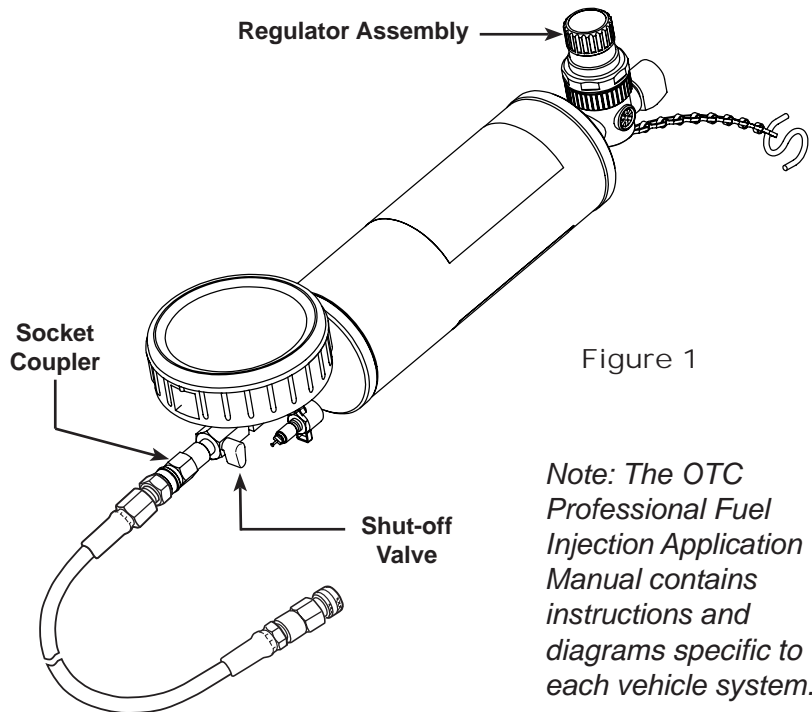

Figure 1

*Note: The OTC Professional Fuel Injection Application Manual contains instructions and diagrams specific to each vehicle system.*

6. Install the hose assembly on the socket coupler as shown.
7. Remove the top and regulator assembly from the container. Pour fuel injector cleaner (one can of OTC No. 7000A - Pro Inject-R-Kleen®) into container. Install top and regulator assembly.
8. Use the chain and hook to hang the Fuel Injector Cleaner from the hood of the vehicle.
9. Refer to the vehicle service manual — or the *OTC Professional Fuel Injection Application Manual* — to determine fuel pressure operating specifications. Connect the Fuel Injector Cleaner to the inlet of the fuel rail. *Note: To keep cleaner fluid from going back to tank, block the fuel return line or adjust the regulator to run vehicle at 5 PSI under fuel pressure specifications.*
10. Turn regulator on top of Fuel Injector Cleaner to full OPEN position (counterclockwise).
11. Attach a shop air hose to the fitting on top of cleaner container.
12. Adjust regulator (by turning it clockwise) to the vehicle manufacturer's fuel running specification, or 5 PSI under the manufacturer's specs. to prevent fuel return.
13. Open shut-off valve to full OPEN position (counterclockwise).
14. Start engine and let it run at 1,000 – 1,500 RPM. *Note: Adjust air pressure to obtain a smooth RPM, if necessary.*
15. Run engine until container is empty and engine stalls.
16. Turn OFF ignition.
17. Turn shut-off valve to full OFF (clockwise).
18. Disconnect air supply. Turn regulator to full OPEN (counterclockwise) to release pressure in container.
19. Remove cleaner. Remove fuel adapter fitting. Connect fuel line. Remove block on fuel return line and connect fuel return line, if applicable. Connect fuel pump power.
20. Start the engine and check for fuel leaks.

# Decarbonizing the Engine

1. Read, understand, and follow *Safety Precautions* in this document before using the Fuel Injector Cleaner.
2. Run the vehicle until the engine reaches normal operating temperature. Shut OFF the engine.
3. Turn regulator on top of Fuel Injector Cleaner to full OPEN position (counterclockwise). Leave the fitting on the end of the regulator open— do NOT connect shop air.
4. Close the shut-off valve at the bottom of the Fuel Injector Cleaner. *Note: Valve is OFF if it is turned all the way clockwise.*
5. Remove top and regulator assembly from Fuel Injector Cleaner. Fill the container with up to 16 oz. of decarbonizing fluid. Install top and regulator assembly.
6. Connect the canister hose to the decarbonizing adapter (OTC No. 7666).
7. Locate a manifold vacuum port (NOT ported vacuum) near the throttle body or carburetor. This will more evenly distribute the decarbonizing solution.
8. Connect the decarbonizer hose / adapter to the manifold vacuum port. See Figure 2.

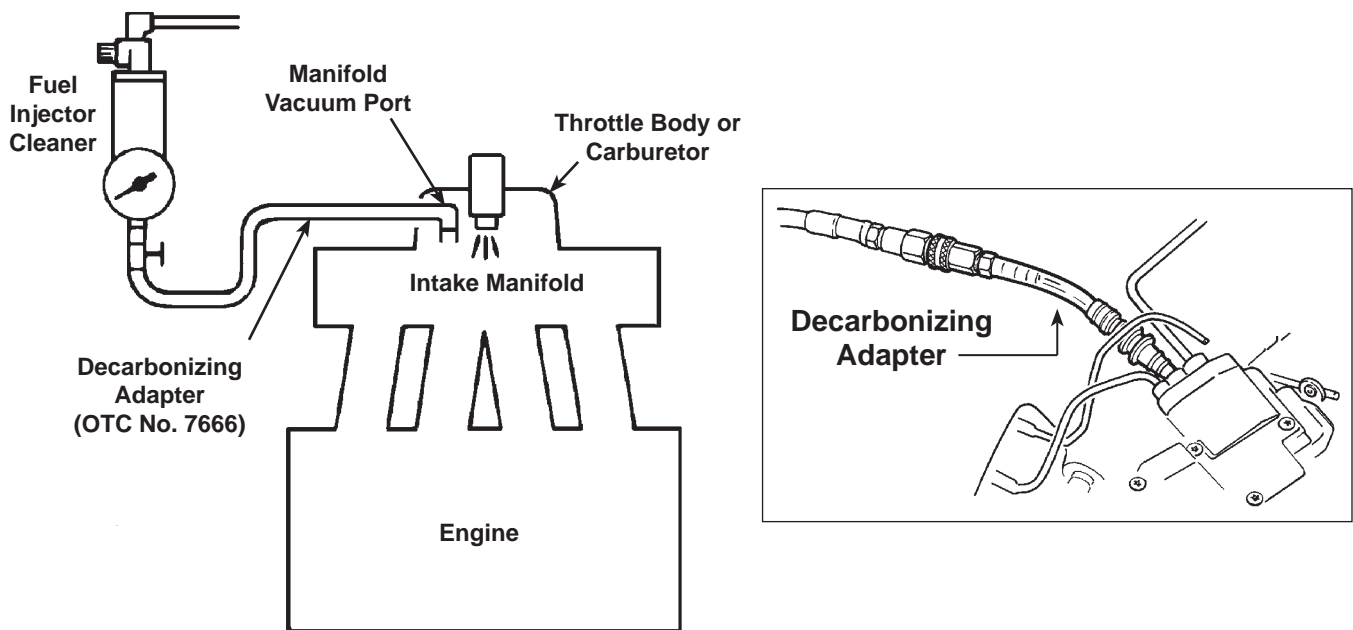

Figure 2

9. Start the engine. Manually increase throttle to 1,500 RPM while slowly opening the shut-off valve. The engine will run rough and RPM will decrease. Do NOT manually increase RPM.
10. When the container is empty, turn OFF the engine.
11. Remove the adapter fitting from the engine. Connect the vacuum hose.
12. Let the vehicle sit for at least 30 minutes to allow the solution to work on soft carbon deposits.
13. Test drive the vehicle for at least 15 miles to flush loosened carbon deposits out of the system.

*Note: Until the system is cleaned out, the vehicle may start hard, run rough, and there may be heavy white smoke from the tailpipe.*

# Clean the Fuel Injector Tool

1. Install the quick coupler onto the end of the hose assembly.
2. Turn OFF the shut-valve at the bottom of the fuel injector cleaner. *Note: Valve is OFF if it is turned all the way clockwise.*
3. Turn regulator on top of Fuel Injector Cleaner to full OPEN position (counterclockwise).
4. Attach a shop air hose to the fitting on top of the cleaner container.
5. Insert the hose into a suitable container.
6. Adjust the air regulator to 50 PSI.
7. Turn the valve on the bottom the fuel injector cleaner to the OPEN position.
8. Let the cleaner flow into the container until the hose is empty.

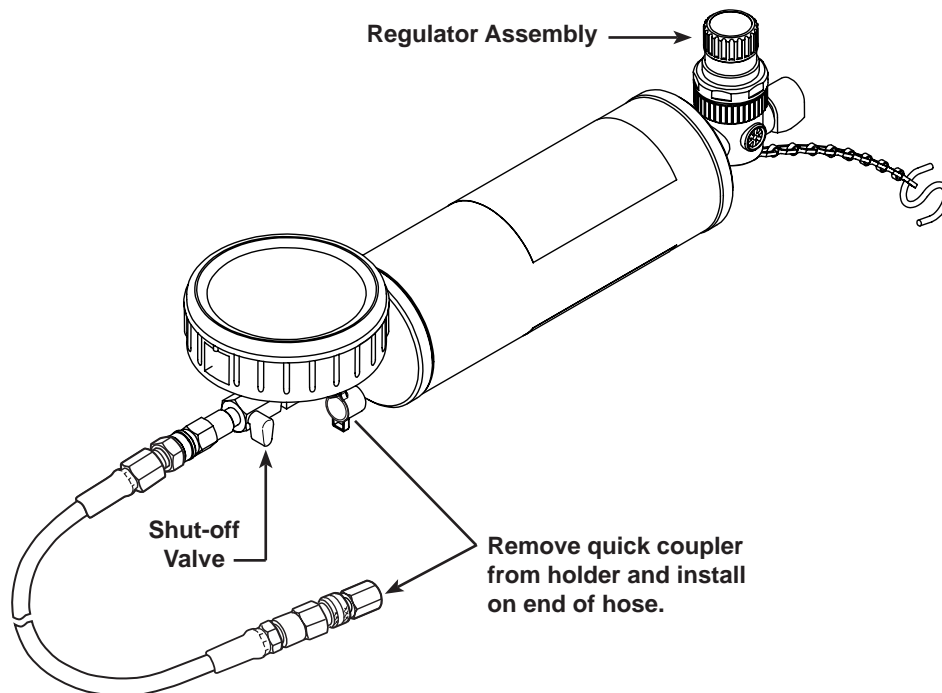

Figure 2