



GM 6-Cylinder Cam Tool Set

3.0L and 3.2L

Operating Instructions



Set Includes:

Camshaft Locking Tool	536594
Camshaft Locking Tool	536595
Crankshaft Holding Tool	536596
Camshaft Alignment Gauge	536608
Timing Belt Installation Tool	536611
Timing Belt Tensioner Wrench	536612
Crankshaft Socket	536613

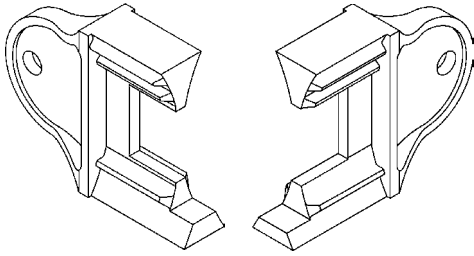

No. 536594 & 536595 Camshaft Locking Tools

Application : 2002–2003 3.2L VIN N used in Cadillac CTS
1997–2001 3.0L VIN R used in Cadillac Catera
2001–2007 3.0L VIN R used in Saturn L300 & LW300
1996–2003 3.0L used in Saab 9.5

NOTE: No. 536594 and No. 536595 are to be used together.

1. To ensure the valves will not hit the pistons, the crankshaft must **NOT** be at top dead center (TDC) at the start of this procedure.
2. Turn the camshaft and drive sprocket to align the timing mark on the sprocket with the timing mark on the timing cover.
3. Install the No. 536594 and No. 536595 locking tools to hold the camshafts in time.
4. Rotate the crankshaft to TDC #1.

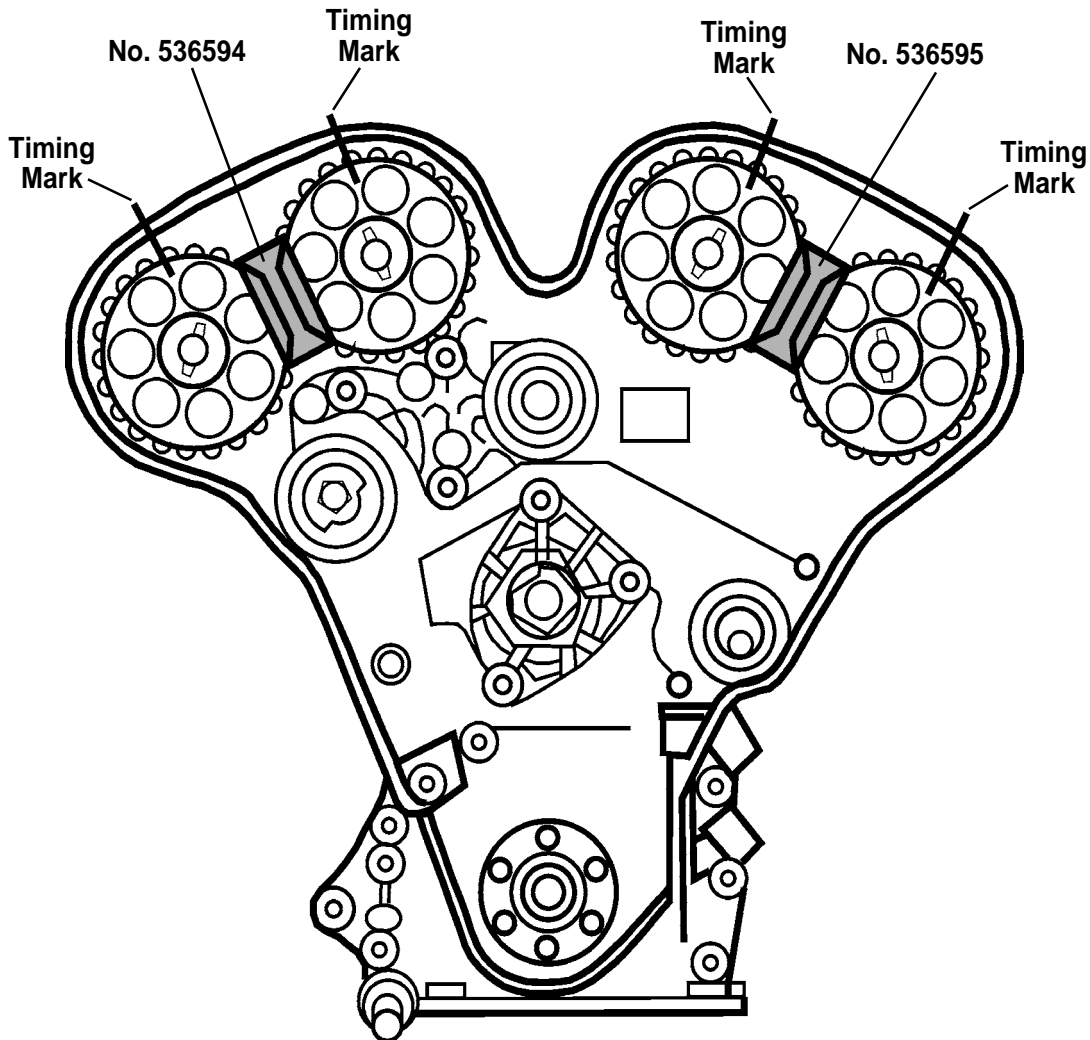

No. 536596 Crankshaft Holding Tool

Application : 2002–2003 3.2L VIN N used in Cadillac CTS
1997–2001 3.0L VIN R used in Cadillac Catera
2001–2007 3.0L VIN R used in Saturn L300 & LW300
1996–2003 3.0L used in Saab 9.5

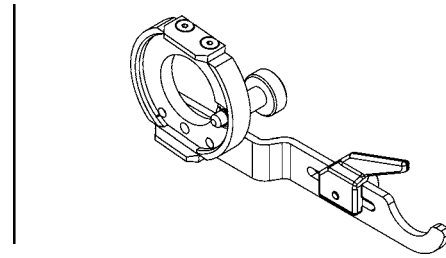

1. Use No. 536613 crankshaft socket to rotate the crankshaft to TDC #1 on the compression stroke. Rotate the crankshaft counterclockwise (CCW) until the timing mark on the crankshaft is at the 6:00 position.
2. Use No. 536613 crankshaft socket to rotate the crankshaft 60° counterclockwise (CCW). See Figure 1.

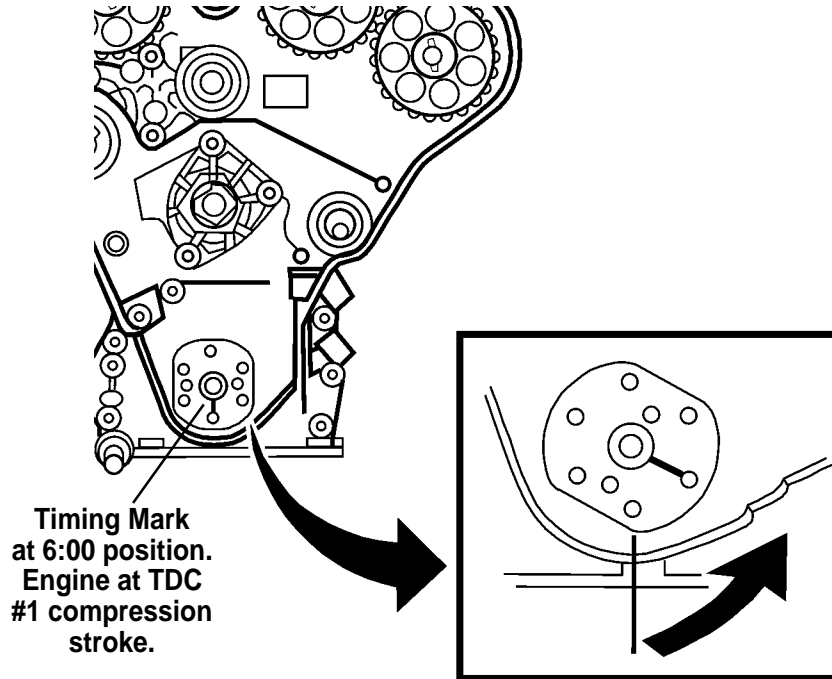

Figure 1

3. Install No. 536596 to the crankshaft sprocket with the knurled bolt. The moveable lever of No. 536596 must be in the bottom of the slot.
4. Rotate the crankshaft clockwise (CW) until the arm of No. 536596 contacts the water pump pulley flange. Secure the moveable lever of No. 536596 to the water pump pulley flange. The #1 cylinder is at TDC on the compression stroke. See Figure 2.

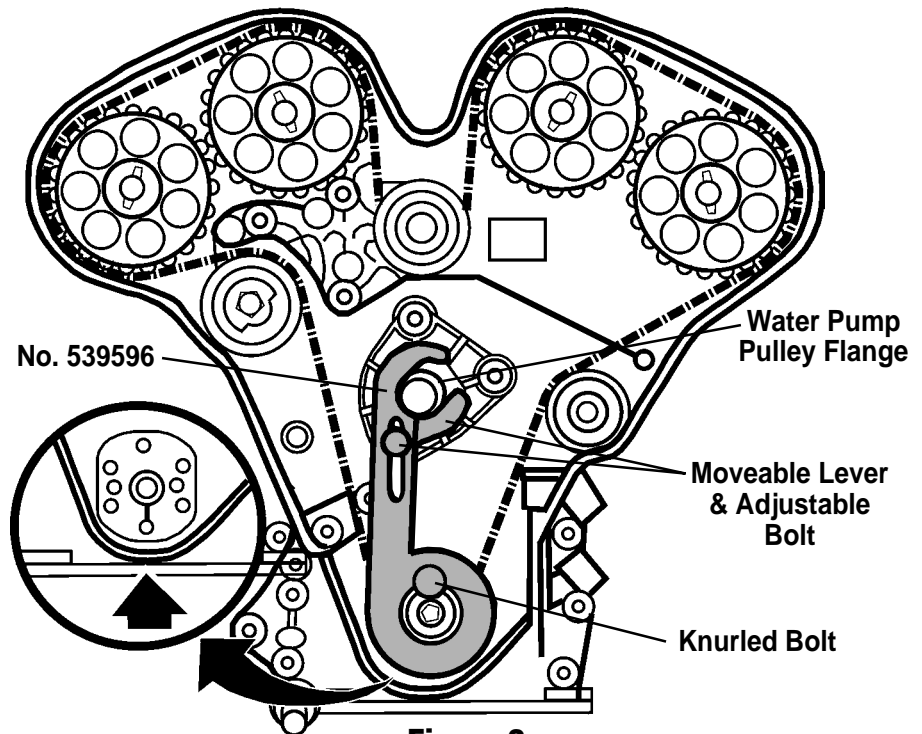

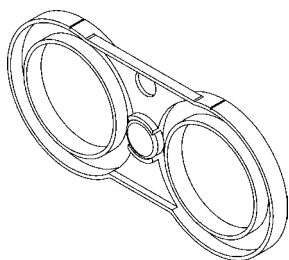

Figure 2

 CAUTION: To prevent personal injury, wear eye protection that meets ANSI Z87.1 and OSHA standards.



No. 536608 Camshaft Alignment Gauge

Application : 2002–2003 3.2L VIN N used in Cadillac CTS
1997–2001 3.0L VIN R used in Cadillac Catera
2001–2007 3.0L VIN R used in Saturn L300 & LW300
1996–2003 3.0L used in Saab 9.5

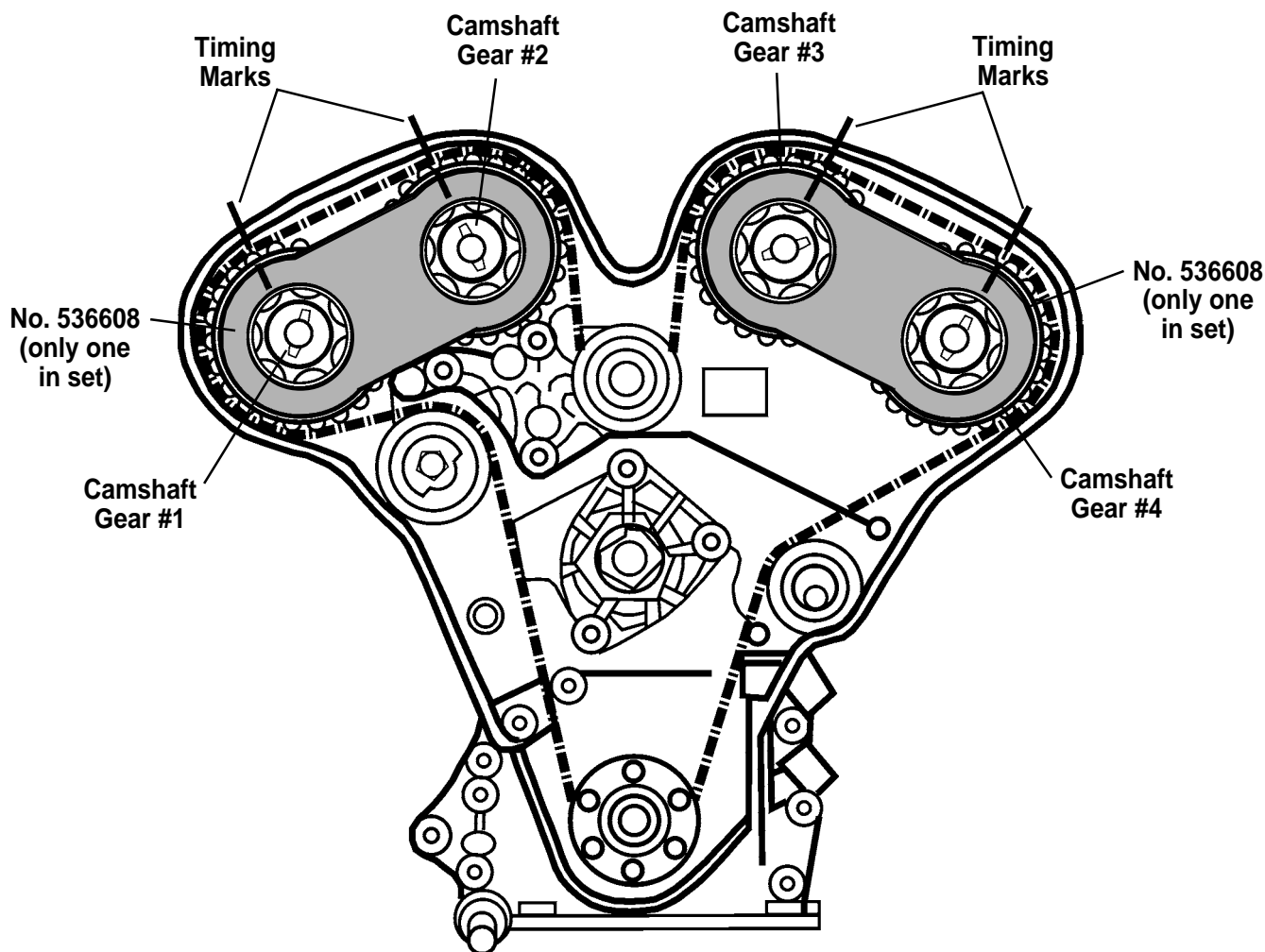

No. 536608 is used to check the camshaft gear alignment—with the timing belt on the engine and tightened to specifications.

1. Set the engine at TDC #1 compression stroke.
2. Assemble No. 536608 camshaft alignment gauge on timing gears #1 & #2 as shown.
3. The timing marks must line up exactly with the marks on the camshaft alignment gauge. If they are perfectly aligned, proceed to step 4. If they are not perfectly aligned, the timing belt will have to be removed, the engine put back in time, and the timing belt reinstalled.
4. Assemble No. 536608 camshaft alignment gauge on timing gears #3 & #4 as shown.
5. The timing marks must line up exactly with the marks on the camshaft alignment gauge. If they are perfectly aligned also, the cam timing is good. If they are not perfectly aligned, the timing belt will have to be removed, the engine put back in time, and the timing belt reinstalled.

 **CAUTION:** To prevent personal injury, wear eye protection that meets ANSI Z87.1 and OSHA standards.

No. 536611 Timing Belt Installation Tool

Application : 2002–2003 3.2L VIN N used in Cadillac CTS
1997–2001 3.0L VIN R used in Cadillac Catera
2001–2007 3.0L VIN R used in Saturn L300 & LW300
1996–2003 3.0L used in Saab 9.5

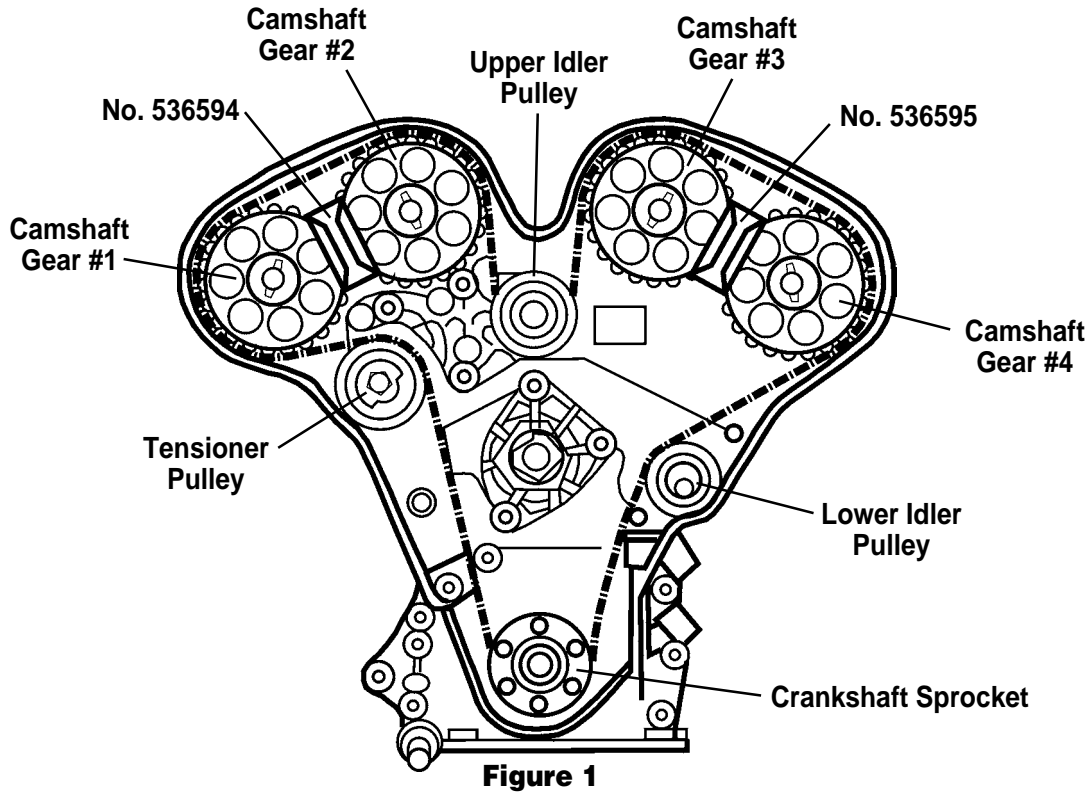
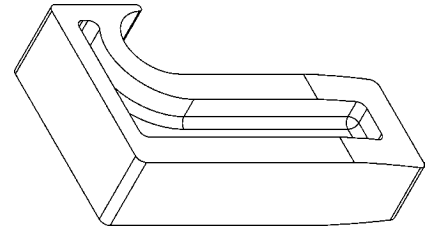

1. With the tensioner pulley loose and No. 536594 and No. 536595 camshaft locking tools in place, install the timing belt following these steps:

Step 1: Install the belt onto camshaft gears #1 & #2.

Step 2: Install the belt around the upper idler pulley.

Step 3: Install the belt onto camshaft gears #3 & #4.

Step 4: Install the belt on the lower idler pulley.

Step 5: Install the belt onto the crankshaft sprocket.

Note: The crankshaft sprocket timing mark must be at 6:00 TDC #1 compression stroke.

Step 6: Lock the timing belt onto the crankshaft sprocket using No. 536611 timing belt installation tool. See Figure 2.

Step 7: Install the belt onto the tensioner pulley.

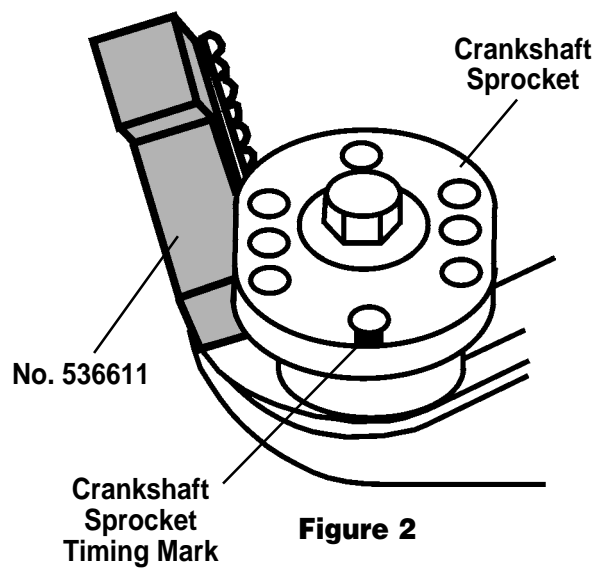

 **CAUTION:** To prevent personal injury, wear eye protection that meets ANSI Z87.1 and OSHA standards.

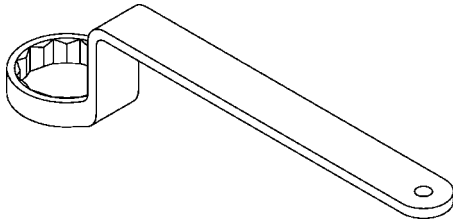

No. 536612 Timing Belt Tensioner Wrench

Application : 2002–2003 3.2L VIN N used in Cadillac CTS
1997–2001 3.0L VIN R used in Cadillac Catera
2001–2007 3.0L VIN R used in Saturn L300 & LW300
1996–2003 3.0L used in Saab 9.5

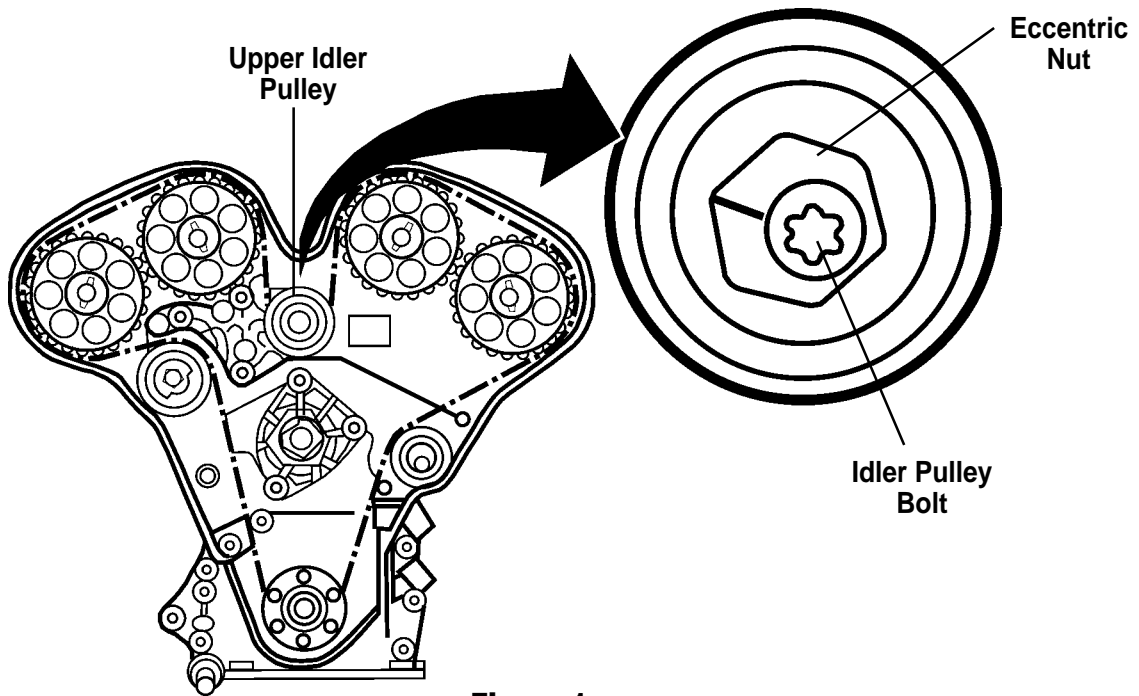

Figure 1

1. Use No. 536612 timing belt tensioner wrench to turn the eccentric nut on the upper idler pulley to set the belt tension. When the belt tension has been set to specification, torque the upper idler pulley bolt to 30 ft. lbs.



CAUTION: To prevent personal injury, wear eye protection that meets ANSI Z87.1 and OSHA standards.

No. 536613 Crankshaft Socket

Application : 2002–2003 3.2L VIN N used in Cadillac CTS
1997–2001 3.0L VIN R used in Cadillac Catera
2001–2007 3.0L VIN R used in Saturn L300 & LW300
1996–2003 3.0L used in Saab 9.5

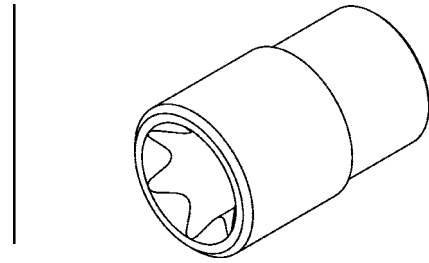

1. Use No. 536613 crankshaft sprocket to rotate the crankshaft as needed when performing the timing procedure.

