

# Company Profile



*People guided by total quality concepts*



Automotive Steering and Suspension Parts



# About OCAP



In 1975 Ivano Giordano created O.C.A.P. S.n.c., acronym of Officine Canavesane di Precisione (Precision Workshops of the Canavese area), specialized in the manufacturing of automotive steering and suspension parts for all vehicles with steering wheels.

OCAP started soon growing and expanding its activities, becoming more and more a point of reference in the field of automotive steering and suspension parts. The company enriched its product offer and market share also through some acquisitions and takeovers and strengthened its appeal on the market by adding many new applications for light commercial vehicles, trucks, construction machines and agricultural vehicles. At the beginning of the new millennium, OCAP reacted to the globalizing market changes and to the modified customer requirements with an ambitious strategic international investment plan.

In 2001 a new production plant was created in the Rajasthan State, in India: OCAP Chassis Parts Pvt. Ltd.

In 2004 a new plant was built in Oglianico near Turin, Italy, where O.C.A.P. International S.r.l. has its headquarter and where the aftermarket commercial and logistic activities are concentrated with a fully automated warehouse for the storage and distribution of all spare parts.

In 2007 OCAP expanded further with the foundation in China of OCAP Chassis Parts (Kunshan) Co. Ltd., in Jiangsu province, a plant dedicated mainly to highly technological components.

Today OCAP is a Group, managed by a holding company, O.C.A.P. S.p.A., with four operational plants.

A success story that continues its development worldwide in the OEM as well as in the IAM markets.



# R&D

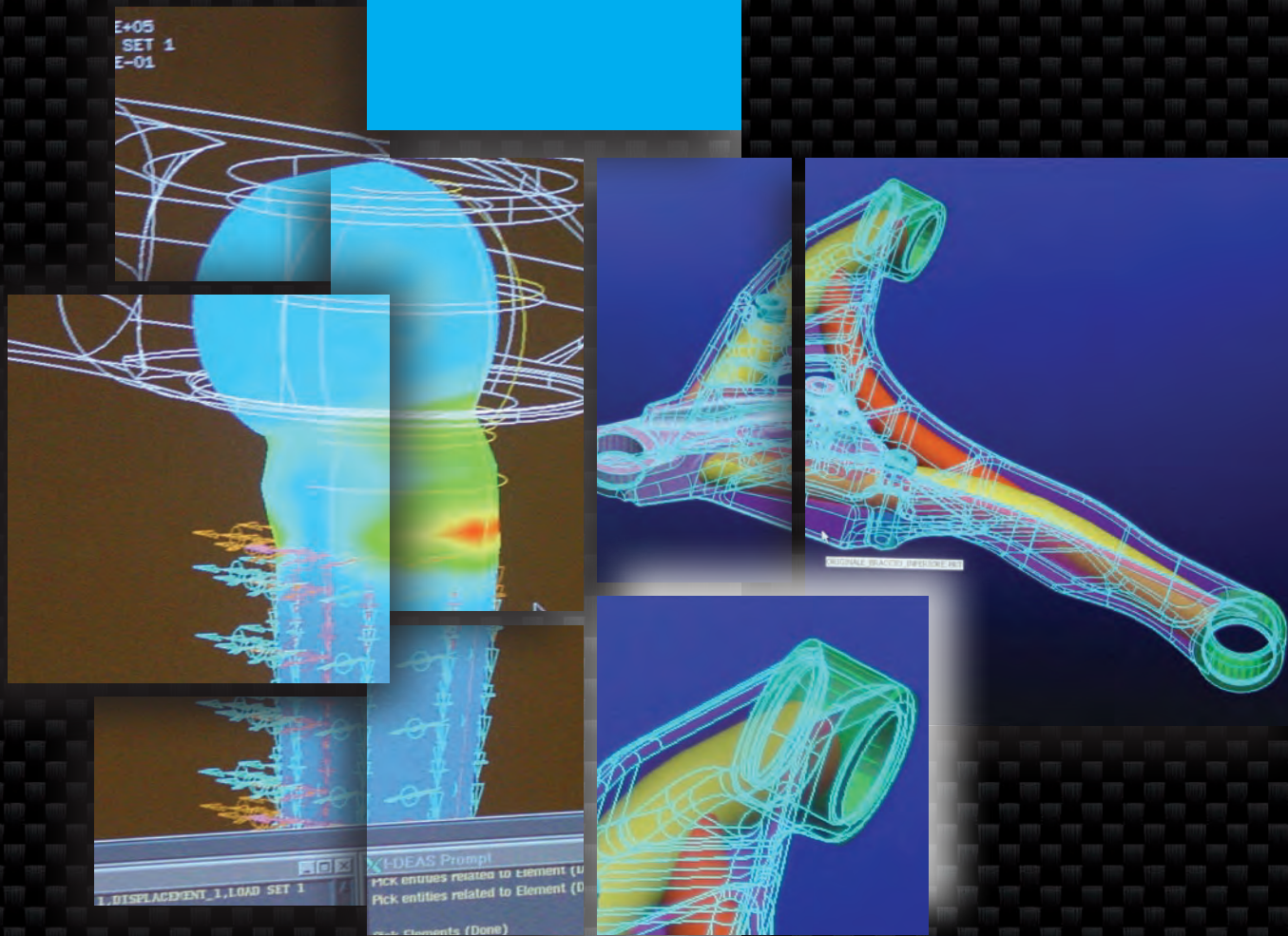

Permanent innovation is amongst the competitive advantages of OCAP. Its strong R&D department is continuously enforced with its own innovative technologies and this permits OCAP to be above all a reliable manufacturer of quality products with a high performing content. New concepts and intuitions have led to many successful applications and to a consistent richness of technical and technological know how. The development of a new component starts with a deep functional, qualitative and cost analysis. The different possible solutions are implemented with 3D CAD and checked with kinematic and structural simulations by FEM/FEA tooling. Every step of the product development is planned, performed and monitored according to the APQP methodology with an interdisciplinary approach involving various OCAP departments. Every new part is tested in the Valperga plant on advanced test benches able to analyze the most complex steering and suspension systems, simulating various road and environmental conditions. Sometimes additional field tests are carried out.

## Production and Products

In the last years, OCAP has deeply renewed its machinery in order to increase its manufacturing capacity and production quality analysis and to better monitor its complete production process. Many automations linked to the installation of more anthropomorphic robots have been introduced and a major versatility has been obtained through semiautomatic work areas. Particular efforts are made in the field of World Class Manufacturing with lean production and total quality principles. OCAP covers a wide range of applications: passenger cars, light commercial vehicles, trucks and buses, construction and agricultural machines. OCAP is also active developing products for special vehicles (race, mini and electric cars, quads, snowmobiles, military vehicles, trailers, motorcycles). OCAP covers the complete steering and suspension parts offer with tie rods, tie rod ends, axial joints, ball joints, track control arms, silentblocks, stabilizers, steering boot kits, repair kits, engine mounts, torque rods, V links and king pin sets.



# Quality & Logistics

## Quality

Indeed, quality is part of the DNA of the whole staff in all the various departments of the Company. The claim "People guided by total quality concepts" is a reality with its imprinting from product design to production and from order management to logistic performances. All are focused on the same target: the full customer satisfaction. The ISO/TS 16949 and ISO 9001 certifications bear amongst others witness of this commitment.

An eco-friendly development is evident and solid at OCAP and its environmental efforts are confirmed by the ISO 14001 certification.

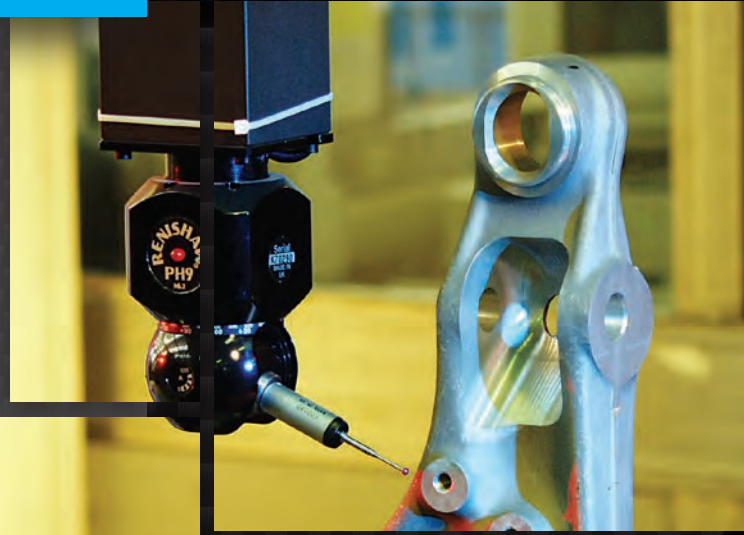

## Aftermarket logistics

OCAP International with its aftermarket headquarter in Oglianico has an impressive logistic centre. The various areas for product reception and warehouse allocation, order picking and shipment preparation are organized around the real heart of the centre, the vertical automated warehouse.

This structure, 27 meters high, 113 meters long and 22 meters wide, is equipped with 20.000 loading units moved by five S/R machines.

The ordered goods are prepared at four picking bays where they are packed and the parcels are strapped and wrapped. They are then transferred from there to one of the six shipment bays and loaded.



# OEM

Since its foundation, OCAP is an active supplier of steering and suspension parts to the vehicle manufacturers, first in Europe and now as well in America and in Asia.

OCAP supplies not only high volume parts but is particularly appreciated by its original equipment customers for the quick development, production and supply for smaller series vehicles with top performance needs.

OCAP is today one of the main OEM suppliers of chassis parts for luxury and upper class passenger cars.

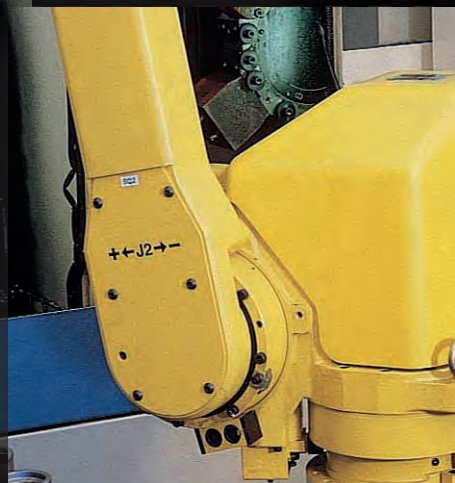
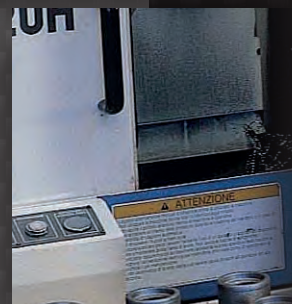
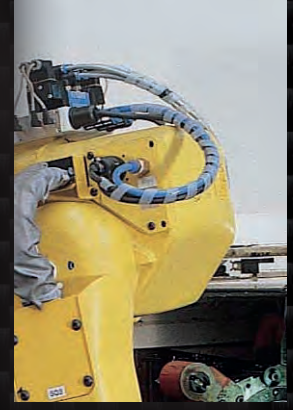
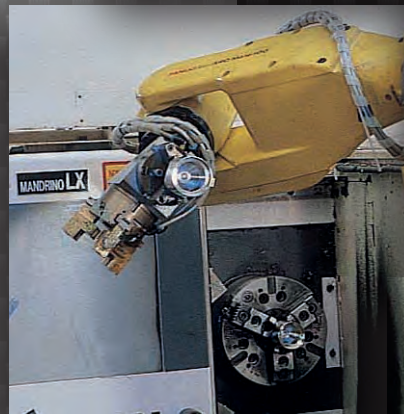

Amongst others, we can find OCAP parts on the vehicles of following manufacturers:

- *car OEM customers:* Fiat Chrysler Automobiles, KIA, Lamborghini, Lotus, Maserati, McLaren, Nissan, Pagani, Peugeot, PGO, Renault Sport;
- *truck OEM customers:* DAF, DANA, Iveco, Leyland Trucks, Piaggio, SNVI, Streparava;
- *agricultural vehicles OEM customers:* BCS, Carraro, Case, Caterpillar, Claas, Comer Industries, Dana, Deutz-Fahr, Fendt, Iseki, JCB, John Deere, Landini, Liebherr, Lovol, Mahindra Tractors, Manitou, Massey Ferguson, McCormick, Merlo, New Holland, Same, Steyr, Terex, Terradrive, Valmet, Valpadana, Valtra, Yanmar.



# IAM

OCAP is a leading supplier of premium quality steering and suspension components to the vehicle manufacturers as well as to the Independent Aftermarket. OCAP continues to acquire market share in the car and truck sector as well as in the field of agricultural vehicles and construction machines.

The organization and efficiency of its worldwide independent aftermarket distribution network in the five continents with various hundreds of customers in more than 70 countries guarantee to OCAP an increasing market presence. Moreover, OCAP products can be found in the boxes of various relevant IAM players.

Thanks to its dynamic marketing staff the Company extends its product range up to even more than 50 new part numbers each month and assures a competitive price positioning on the IAM market for its quality products. Its wide range of products with more than 10.000 part numbers are well illustrated with many details in the various catalogues and CD/DVD as well as in Tec Doc.







OCCAP | GROUP

Trucks and Buses

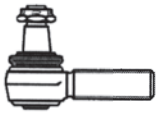
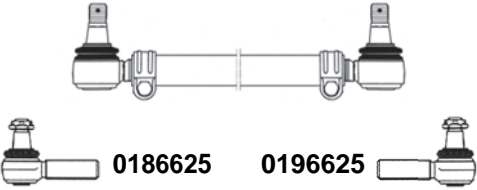

## HOW TO USE THE CATALOGUES

RIF. ORIG O.E. NUMBER	RIF. ORIG O.E. NUMBER	NOTE REMARKS	MODELLO MODEL
<b>0186622 [1]</b> 	<b>42493781</b> 2966688 <b>[2]</b>	M=30x1,5 RHT L= 115 m=20x1,5	EUROARGO: 120E15/E18/E23 130E15/E18/E23 150E15/E23/E27 R 260E23T-280E23T 320E27T
<b>0186622</b>  <b>[5]</b>	<b>98458724</b> 98427667	L=1636 <b>[3]</b>	EUROTECH: 180E24/27/30 190E24/27/30 400E30/34 <b>[4]</b>

	I	GB	D	F	E
<b>[1]</b>	Riferimento OCAP	OCAP References	OCAP Nummern	Références OCAP	Referencias OCAP
<b>[2]</b>	Riferimento originale	Original number	Originalnummern	Numero original	Numero original
<b>[3]</b>	Note	Remarks	Bemerkungen	Remarques	Observaciones
<b>[4]</b>	Modello	Model	Modell	Modell	Modelo
<b>[5]</b>	Teste di ricambio	Tie rod ends	Kugelgelenk	Rotules	Ròtulas

**ALL VEHICLE MANUFACTURES NAMES AND ORIGINAL PART NUMBER IN THIS CATALOG ARE FOR REFERENCE PURPOSES ONLY**

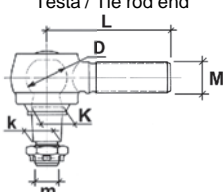
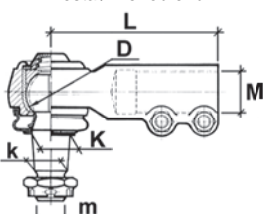
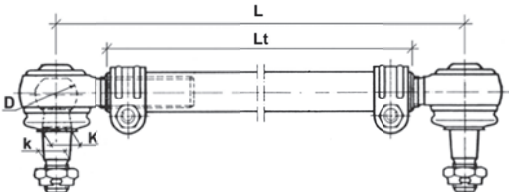
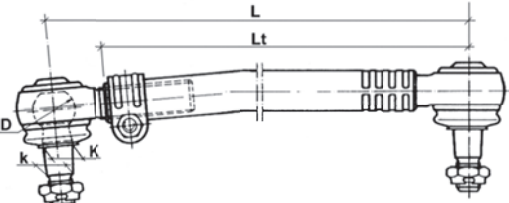
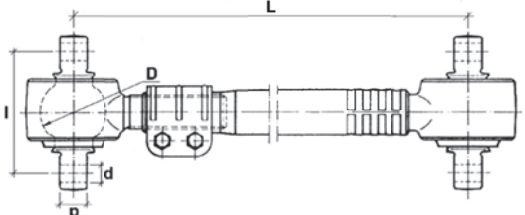
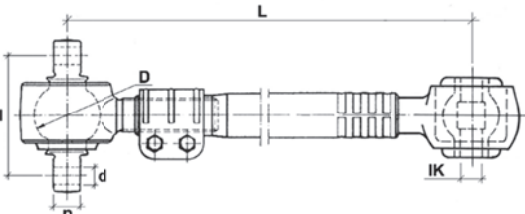
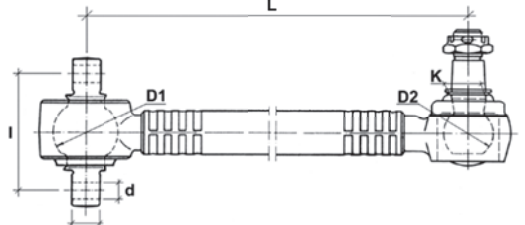

## ITEMMS DESCRIPTION

<p>Testa / Tie rod end</p> 	<p>M = Filetto gambo testa - Thread metrie m            = Filetto perno testa - Thread metrie pin            L = Lunghezza da centro testa a fine gambo - Center to end of shaft            D = Diametro sfera - Ball pin diameter            K = Diametro cono base perno - Taper diameter max. size            k = Diametro cono inizio perno - Taper diameter min. size</p>
<p>Testa / Tie rod end</p> 	<p>M = Filetto interno gambo testa - Internal thread metrie            m = Filetto perno testa - Thread metrie pin            L = Lunghezza da centro testa a fine gambo - Center to end of shaft            D = Diametro sfera - Ball pin diameter            K = Diametro cono base perno - Taper diameter max. size            k = Diametro cono inizio perno - Taper diameter min. size</p>
<p>Barra accoppiamento / Tie rod</p> 	<p>L = Lunghezza da centro testa a centro testa - Distance center to centre distance            Lt = Lunghezza tubo - Tube length            D = Diametro sfera - Ball pin diameter            K = Diametro cono base perno - Taper diameter max. size            k = Diametro cono inizio perno - Taper diameter min. size</p>
<p>Tirante longitudinale / Drag link</p> 	<p>L = Lunghezza da centro testa a centro testa - Distance center to centre distance            Lt = Lunghezza da centro testa a fine tubo - Distance centre fixed tie rod to end of tube            D = Diametro sfera - Ball pin diameter            K = Diametro cono base perno - Taper diameter max. size            k = Diametro cono inizio perno - Taper diameter min. size</p>
<p>Barra reazione / Torque rod</p> 	<p>L = Lunghezza da centro testa a centro testa - Distance center to centre distance            D = Diametro sfera - Ball pin diameter            d = Diametro foro perno - Hole pin diameter            p = S Hole spessore perno - Broad            I = Interasse fori perno - Hole pin distance</p>
<p>Barra reazione / Torque rod</p> 	<p>L = Lunghezza da centro testa a centro testa - Distance center to centre distance            D = Diametro sfera - Ball pin diameter            d = Diametro foro perno - Hole pin diameter            p = Spessore perno - Broad            I = Interasse fori perno - Hole pin distance            IK = Diametro foro sfera - Hole ball pin diameter</p>
<p>Barra reazione / Torque rod</p> 	<p>L = Lunghezza da centro testa a centro testa - Distance center to centre distance            D1 = Diametro sfera - Ball pin diameter            D2 = Diametro sfera - Ball pin diameter            K = Diametro cono base perno - Taper diameter max. size            d = Diametro foro perno - Hole pin diameter            p = Spessore perno - Broad            I = Interasse fori perno - Hole pin distance</p>

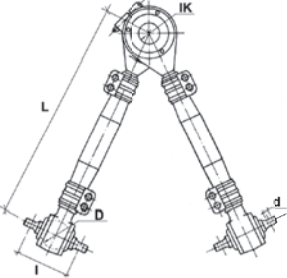
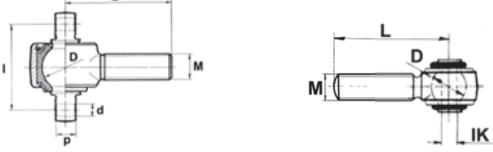
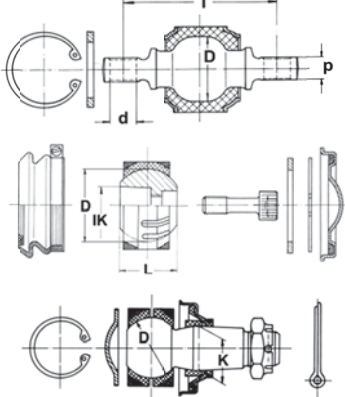
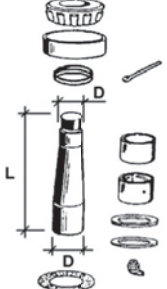

<p>Barra reazione triangolare/ Triangular torque rod</p> 	<p>L = Lunghezza da centro testa a centro testa - Distance center to centre distance  D = Diametro sfera - Ball pin diameter  d = Diametro foro perno - Hole pin diameter  p = Spessore perno - Broad  I = Interasse fori perno - Hole pin distance  IK = Diametro foro sfera - Hole ball diameter  T = Diametro tubo - Tube diameter</p>
<p>Testa barra / Ball joint</p> 	<p>M = Filetto gambo testa - Thread metric  L = Lunghezza da centro testa a fine gambo - Center to end of shaft  D = Diametro sfera - Ball pin diameter  d = Diametro foro perno - Hole pin diameter  p = Spessore perno - Broad  I = Interasse fori perno - Hole pin distance  IK = Diametro foro sfera - Hole ball diameter</p>
<p>Kit riparazione / Repair kit</p> 	<p>D = Diametro sfera - Ball pin diameter  d = Diametro foro perno - Hole pin diameter  p = Spessore perno - Broad  I = Interasse fori perno - Hole pin distance  K = Diametro cono base perno - Taper diameter max. size  IK = Diametro foro sfera - Hole ball pin diameter  L = Lunghezza sfera - Ball pin distance</p>
<p>Kit Perno Fuso / King Pin Set</p> 	<p>L = Lunghezza perno - Pin distance  D = Diametro perno - Pin diameter</p>









## REPLACED ITEMS

OCAP OLD	>	OCAP NEW	OCAP OLD	>	OCAP NEW	OCAP OLD	>	OCAP NEW	OCAP OLD	>	OCAP NEW
0180047	>	0180027	0187042	>	0186424	0196631	>	0196595	0400805	>	0400518
0180051	>	0180027	0187124	>	0186598	0196643	>	0196598	0402827	>	0401494
0181277	>	0186424	0187145	>	0186598	0196646	>	0196424	0404614	>	0401522
0181698	>	0180727	0187148	>	0186598	0196757	>	0196598	0404628	>	0404627
0182100	>	0180027	0187172	>	0186595	0196943	>	0196595	0406671	>	0400518
0182258	>	0182261	0187173	>	0186612	0196944	>	0196612	0503809	>	0503878
0186420	>	0186598	0187174	>	0186613	0196945	>	0196613	0504394	>	0503878
0186423	>	0186613	0187175	>	0186424	0196947	>	0196424	0505622	>	0507124
0186425	>	0186598	0187176	>	0186598	0197124	>	0196598	0506735	>	0506726
0186426	>	0186758	0187225	>	0187228	0197145	>	0196598	0506989	>	0506725
0186436	>	0186595	0187227	>	0187226	0197148	>	0196598	0507162	>	0506951
0186437	>	0186613	0187239	>	0187228	0197172	>	0196595	0581408	>	0581407
0186438	>	0186424	0187255	>	0187228	0197173	>	0196612	0582828	>	0583812
0186439	>	0186598	0187574	>	0187146	0197174	>	0196613	0591408	>	0591407
0186441	>	0186599	0187597	>	0186599	0197175	>	0196424	0592828	>	0593812
0186447	>	0180730	0187783	>	0186424	0197176	>	0196598	0601496	>	0603811
0186448	>	0186595	0190730	>	0190731	0197882	>	0196598	0602322	>	0604424
0186449	>	0186612	0191277	>	0196424	0198102	>	0196424	0602826	>	0603811
0186506	>	0186613	0192100	>	0190027	0280225	>	0280037	0603807	>	0604424
0186537	>	0186424	0196420	>	0196598	0280858	>	0280037	0782321	>	0783808
0186548	>	0187146	0196423	>	0196613	0280901	>	0280037	0792321	>	0793808
0186550	>	0186598	0196425	>	0196598	0280917	>	0280037	0901112	>	0901169
0186593	>	0186424	0196436	>	0196595	0281181	>	0280515	0901143	>	0900489
0186594	>	0186598	0196437	>	0196613	0282825	>	0281495	0904424	>	0903807
0186596	>	0186613	0196438	>	0196424	0283806	>	0283875	1211231	>	1211063
0186597	>	0186424	0196439	>	0196598	0283810	>	0281495	1211308	>	1211310
0186602	>	0186614	0196440	>	0197146	0284392	>	0283875	1215262	>	1215491
0186609	>	0186599	0196448	>	0196595	0286648	>	0186648	1215645	>	1215173
0186622	>	0186424	0196449	>	0196612	0286649	>	0186649	1215681	>	1215640
0186625	>	0186598	0196506	>	0196613	0286655	>	0186655	1215682	>	1215641
0186629	>	0186424	0196537	>	0196424	0287160	>	0187160	1215859	>	1215870
0186631	>	0186595	0196550	>	0196598	0292825	>	0291495	1225181	>	1225185
0186643	>	0186598	0196593	>	0196424	0293806	>	0293875			
0186646	>	0186424	0196594	>	0196598	0293810	>	0291495			
0186665	>	0286665	0196596	>	0196613	0294392	>	0293875			
0186689	>	0186758	0196597	>	0196424	0381323	>	0381184			
0186757	>	0186598	0196602	>	0196614	0382827	>	0381494			
0186943	>	0186595	0196609	>	0196599	0384628	>	0384627			
0186944	>	0186612	0196622	>	0196424	0391323	>	0391184			
0186945	>	0186613	0196625	>	0196598	0392827	>	0391494			
0186947	>	0186424	0196629	>	0196424	0394628	>	0394627			

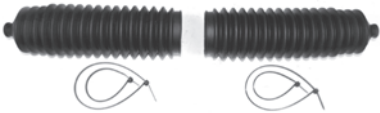







## CITROEN: JUMPER - C25 - 1994 &gt; 2006 -





RIF. OCAP OCAP REF.	RIF. ORIG O.E. NUMBER	NOTE REMARKS	MODELLO / DESCRIZIONE MODEL / DESCRIPTION
0281143 	1306716080 1471655080 4018A3 4018H4	M=16x1,5 RHT	TESTA STERZO - TIE ROD END > 12/2002
0282323 	77362278 4018E0	M=16x1,5 RHT	TESTA STERZO - TIE ROD END 01/2003 >
0601139 	1471654080 400624 4018A4 9945836	M=16x1,5 RHT	SNODO ASSIALE AXIAL JOINT
0900489 	9946982 400622 401815		KIT CUFFIA STERZO - STERZO MANUALE KIT STEERING BOOT - MANUAL STEERING
1211310 	9946982 4018A5		CUFFIA STERZO - SERVOSTERZO STEERING BOOT - POWER STEERING
0900449 	9945837 406635		KIT CUFFIE STERZO - SERVOSTERZO KIT STEERING BOOTS - POWER STEERING
0401137 	1302368080 3640.32 364032		SNODO SOSPENSIONE - BALL JOINT MOD. 1.0 - 1.4 t. > 01/2001
0381141 	1308601080 1317241080 1320787080 352165 3521.65		BRACCIO OSCILLANTE - TRACK CONTROL ARM MOD. 1.0 - 1.4 t. - > 01/2001



**CITROEN: JUMPER - C25 - 1994 > 2006 -**

RIF. OCAP OCAP REF.	RIF. ORIG O.E. NUMBER	NOTE REMARKS	MODELLO / DESCRIZIONE MODEL / DESCRIPTION
<b>0391141</b> 	<b>1308600080</b> 1317240080 1320786080 352095 3520.95		BRACCIO OSCILLANTE - TRACK CONTROL ARM MOD. 1.0 - 1.4 t. - > 01/2001
<b>0401446</b> 	<b>1331640080</b> 364055 3640.55		SNODO SOSPENSIONE - BALL JOINT MOD. 1.0 - 1.4 t. - 02/2001 >
<b>0381446</b> 	<b>1339467080</b> 1331940080 3521J3 3521.J3		BRACCIO OSCILLANTE - TRACK CONTROL ARM MOD. 1.0 - 1.4 t. - 02/2001 >
<b>0391446</b> 	<b>1339465080</b> 1331938080 3520N3 3520.N3		BRACCIO OSCILLANTE - TRACK CONTROL ARM MOD. 1.0 - 1.4 t. - 02/2001 >
<b>0401138</b> 	<b>1300473080</b> 364033 3640.33		SNODO SOSPENSIONE - BALL JOINT MOD. 1.8 t > 01/2001
<b>0381140</b> 	<b>1308760080</b> 1317239080 1320756080 352166 3521.66		BRACCIO OSCILLANTE - TRACK CONTROL ARM MOD. 1.8 t - > 01/2001

## CITROEN: JUMPER - C25 - 1994 &gt; 2006 -







RIF. OCAP OCAP REF.	RIF. ORIG O.E. NUMBER	NOTE REMARKS	MODELLO / DESCRIZIONE MODEL / DESCRIPTION
0391140 	1320755080 1317238080 1308759080 352096 3520.96		BRACCIO OSCILLANTE - TRACK CONTROL ARM MOD. 1.8 t - > 01/2001
0401451 	1331641080 364054 3640.54		SNODO SOSPENSIONE - BALL JOINT MOD. 1.8 t - 02/2001 >
0381451 	1339466080 1331939080 3521J4 3521.J4		BRACCIO OSCILLANTE - TRACK CONTROL ARM MOD. 1.8 t - 02/2001 >
0391451 	1339464080 1331937080 3520N4 3520.N4		BRACCIO OSCILLANTE - TRACK CONTROL ARM MOD. 1.8 t - 02/2001 >
1215176 	-		SILENBLOC CENTRALE CENTRAL BUSHING
1215177 	-		SILENBLOC ESTREMO OUTER BUSHING
0181602 	1300716080		PUNTONE BARRA STABILIZZATRICE STABILIZER LINK



**CITROEN: JUMPER - C25 - 1994 > 2006 -**

RIF. OCAP OCAP REF.	RIF. ORIG O.E. NUMBER	NOTE REMARKS	MODELLO / DESCRIZIONE MODEL / DESCRIPTION
<p><b>0181602-K</b></p> 	<p>1300716080 (1) 15503811 (2) 1300721080 (3) 1300720080 (4)</p>		<p>KIT PUNTONE BARRA STABILIZZATRICE STABILIZER LINK KIT</p>

## CITROEN: JUMPER - 2006 &gt; -









RIF. OCAP OCAP REF.	RIF. ORIG O.E. NUMBER	NOTE REMARKS	MODELLO / DESCRIZIONE MODEL / DESCRIPTION
0282637 	381770 77364009	M=16x1,5 RHT	TESTA STERZO TIE ROD END
0292637 	381777 77364253	M=16x1,5 RHT	TESTA STERZO TIE ROD END
0602637 	4000SF * 4000SG * 1341019080 * 1345854080 *	M=16x1,5 RHT	SNODO ASSIALE AXIAL JOINT
0902637 	406686 77364254		KIT CUFFIA STERZO STEERING BOOT KIT
0402638 	364067 50705629		SNODO SOSPENSIONE - ASSE ANTERIORE BALL JOINT - FRONT AXLE MOD. Q11-Q15-Q17L-Q17Q-Q20
0382638 	3521P1 1352225080		BRACCIO OSCILLANTE - ASSE ANTERIORE - INFERIORE TRACK CONTROL ARM FRONT AXLE - LOWER MOD. Q11-Q15-Q17L
0392638 	3520S0 1352227080		BRACCIO OSCILLANTE - ASSE ANTERIORE - INFERIORE TRACK CONTROL ARM FRONT AXLE - LOWER MOD. Q11-Q15-Q17L



**CITROEN: JUMPER - 2006 > -**

RIF. OCAP OCAP REF.	RIF. ORIG O.E. NUMBER	NOTE REMARKS	MODELLO / DESCRIZIONE MODEL / DESCRIPTION
<b>0382639</b> 	<b>3521P2</b> 1352226080		BRACCIO OSCILLANTE - ASSE ANTERIORE - INFERIORE TRACK CONTROL ARM FRONT AXLE - LOWER MOD. Q17H-Q20
<b>0392639</b> 	<b>3520S1</b> 1352228080		BRACCIO OSCILLANTE - ASSE ANTERIORE - INFERIORE TRACK CONTROL ARM FRONT AXLE - LOWER MOD. Q17H-Q20
<b>1215822</b> 	-		SILENTBLOC CENTRALE - CENTRAL BUSHING
<b>1215823</b> 	-		SILENTBLOC ESTREMO - OUTER BUSHING
<b>0182638</b> 	<b>1350658080 Z</b> 1357572080 Z 5081N9 Z		STABILIZZATORE - ASSE ANTERIORE - STABILIZER LINK - FRONT AXLE
<b>0503520</b> 	<b>1355449080 Z</b>		STABILIZZATORE - ASSE POSTERIORE - STABILIZER LINK - REAR AXLE

## CITROEN: JUMPY - 1995 &gt; 2006 -









RIF. OCAP OCAP REF.	RIF. ORIG O.E. NUMBER	NOTE REMARKS	MODELLO / DESCRIZIONE MODEL / DESCRIPTION
0280037 	405909 9404059080 1306003080 4322906 3265974	M=14x1,5 RHT	TESTA STERZO - TIE ROD END
0600918 	3812A4 9566950880	M=14x1,5 RHT	SNODO ASSIALE - AXIAL JOINT
0381184 	71737048 1313084080 1333755080 1322664080 1317390080 1316736080		BRACCIO OSCILLANTE - TRACK CONTROL ARM
0391184 	71737047 1313083080 1333754080 1322663080 1317389080 1316735080		BRACCIO OSCILLANTE - TRACK CONTROL ARM
1215173 	-		SILENTBLOCK CENTRALE - CENTRAL BUSHING
1215174 	-		SILENTBLOCK ESTREMO - DX OUTER BUSHING - RH
1215175 	-		SILENTBLOCK ESTREMO - SX OUTER BUSHING - LH
0181322-K 	1308664080 * 15503811 * 1311025080 * 1313056080 * 508735 *		KIT PUNTONE BARRA STABILIZZATRICE STABILIZER LINK KIT



## CITROEN: JUMPY - 1995 &gt; 2006 -

RIF. OCAP OCAP REF.	RIF. ORIG O.E. NUMBER	NOTE REMARKS	MODELLO / DESCRIZIONE MODEL / DESCRIPTION
<b>0181322</b> 	<b>508735</b>		PUNTONE BARRA STABILIZZATRICE STABILIZER LINK

## CITROEN: JUMPY - 2007 &gt; -

RIF. OCAP OCAP REF.	RIF. ORIG O.E. NUMBER	NOTE REMARKS	MODELLO / DESCRIZIONE MODEL / DESCRIPTION
<b>0282733</b> 	<b>381773</b> 9403817738	M=14x1,5 RHT	TESTA STERZO - TIE ROD END
<b>0602733</b> 	<b>3812F0</b> 1497552080 1401381380	M=14x1,5 RHT	SNODO ASSIALE STERZO AXIAL JOINT
<b>1211477</b> 	<b>406683 *</b> 9404066838 *		CUFFIA STERZO STEERING GAITER
<b>0902733</b> 	<b>406683</b> 9404066838		KIT CUFFIA STERZO STEERING GAITER KIT
<b>0382734</b> 	<b>3521N9</b> 1497407080		BRACCIO OSCILLANTE TRACK CONTROL ARM
<b>0392734</b> 	<b>3520R8</b> 1497408080		BRACCIO OSCILLANTE TRACK CONTROL ARM
<b>1215646</b> 			SILENTBLOCK ESTREMO - DX OUTER BUSHING - RH
<b>1215647</b> 			SILENTBLOCK ESTREMO - SX OUTER BUSHING - LH



**CITROEN: JUMPY - 2007 > -**

RIF. OCAP OCAP REF.	RIF. ORIG O.E. NUMBER	NOTE REMARKS	MODELLO / DESCRIZIONE MODEL / DESCRIPTION
<p><b>1215870</b></p> 			<p>SILENTBLOCK CENTRALE CENTRAL BUSHING</p>
<p><b>0502735</b></p> 	<p><b>508756</b> 1400099680</p>		<p>STABILIZZATORE - ASSE ANTERIORE STABILIZER LINK - FRONT AXLE</p>

## FIAT: DUCATO - TALENTO - &gt; 1994 -

RIF. OCAP OCAP REF.	RIF. ORIG O.E. NUMBER	NOTE REMARKS	MODELLO / DESCRIZIONE MODEL / DESCRIPTION
0501112 	9790002680		BARRA STERZO TIE ROD
0280513 	9750079980	M=16x1,5 RHT	TESTA STERZO TIE ROD END
0600514 	9750390080	M=16x1,5 RHT	SNODO ASSIALE AXIAL JOINT
1211063 	9750000380		CUFFIA STERZO SINGLE STEERING BOOT
1211064 	9750000280		CUFFIA STERZO SINGLE STEERING BOOT
0901169 	-		KIT CUFFIE STERZO KIT STEERING BOOTS
0400097 	4388159		SNODO SOSPENSIONE INFERIORE > 10/1985 SUSPENSIONE JOINT LOWER
0380405 	4391813		BRACCIO OSCILLANTE - TRACK CONTROL ARM > 09/1985



**FIAT: DUCATO - TALENTO - > 1994 -**







RIF. OCAP OCAP REF.	RIF. ORIG O.E. NUMBER	NOTE REMARKS	MODELLO / DESCRIZIONE MODEL / DESCRIPTION
<b>0390405</b> 	<b>4391814</b>		BRACCIO OSCILLANTE - TRACK CONTROL ARM > 09/1985
<b>0400096</b> 	<b>7567284</b>		SNODO SOSPENSIONE INFERIORE - 10/1985 > SUSPENSIONE JOINT LOWER
<b>0380406</b> 	<b>7695190</b>		BRACCIO OSCILLANTE - TRACK CONTROL ARM 10/1985 >
<b>0390406</b> 	<b>7695191</b>		BRACCIO OSCILLANTE - TRACK CONTROL ARM 10/1985 >
<b>0901527</b> 	-		KIT SILENTBLOC + TUBETTO BUSHING KIT
<b>0380565</b> 	<b>7695185</b>		BRACCIO OSCILLANTE - TRACK CONTROL ARM MOD.1.8 t - 10/1985 >
<b>0390565</b> 	<b>7695186</b>		BRACCIO OSCILLANTE - TRACK CONTROL ARM MOD.1.8 t - 10/1985 >
<b>0901528</b> 	-		KIT SILENTBLOC + TUBETTO - BUSHING KIT MOD. 1.8 t

## FIAT: DUCATO - TALENTO - &gt; 1994 -



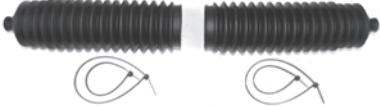



RIF. OCAP OCAP REF.	RIF. ORIG O.E. NUMBER	NOTE REMARKS	MODELLO / DESCRIZIONE MODEL / DESCRIPTION
1215388 	4339248		BOCCOLA BARRA STABILIZZATRICE RUBBER RING FOR STABILIZING BAR









**FIAT: DUCATO - 1994 > 2006 -**

RIF. OCAP OCAP REF.	RIF. ORIG O.E. NUMBER	NOTE REMARKS	MODELLO / DESCRIZIONE MODEL / DESCRIPTION
<b>0281143</b> 	<b>1306716080</b> 1471655080 4018A3 4018H4	M=16x1,5 RHT	TESTA STERZO - TIE ROD END > 12/2002
<b>0282323</b> 	<b>77362278</b> 4018E0	M=16x1,5 RHT	TESTA STERZO - TIE ROD END 01/2003 >
<b>0601139</b> 	<b>1471654080</b> 400624 4018A4 9945836	M=16x1,5 RHT	SNODO ASSIALE AXIAL JOINT
<b>0900489</b> 	<b>9946982</b> 400622 401815		KIT CUFFIA STERZO - STERZO MANUALE KIT STEERING BOOT - MANUAL STEERING
<b>1211310</b> 	<b>9946982</b> 4018A5		CUFFIA STERZO - SERVOSTERZO STEERING BOOT - POWER STEERING
<b>0900449</b> 	<b>9945837</b> 406635		KIT CUFFIE STERZO - SERVOSTERZO KIT STEERING BOOTS - POWER STEERING
<b>0401137</b> 	<b>1302368080</b> 3640.32 364032		SNODO SOSPENSIONE - BALL JOINT MOD. 1.0 - 1.4 t. > CH. 6086766
<b>0381141</b> 	<b>1308601080</b> 1317241080 1320787080 352165 3521.65		BRACCIO OSCILLANTE - TRACK CONTROL ARM MOD. 1.0 - 1.4 t. - > CH. 6086766

## FIAT: DUCATO - 1994 &gt; 2006 -



RIF. OCAP OCAP REF.	RIF. ORIG O.E. NUMBER	NOTE REMARKS	MODELLO / DESCRIZIONE MODEL / DESCRIPTION
0391141 	1308600080 1317240080 1320786080 352095 3520.95		BRACCIO OSCILLANTE - TRACK CONTROL ARM MOD. 1.0 - 1.4 t. -> CH. 6086766
0401446 	1331640080 364055 3640.55		SNODO SOSPENSIONE - BALL JOINT MOD. 1.0 - 1.4 t. - CH. 6086766 >
0381446 	1339467080 1331940080 3521J3 3521.J3		BRACCIO OSCILLANTE - TRACK CONTROL ARM MOD. 1.0 - 1.4 t. CH. 6086766 >
0391446 	1339465080 1331938080 3520N3 3520.N3		BRACCIO OSCILLANTE - TRACK CONTROL ARM MOD. 1.0 - 1.4 t. CH. 6086766 >
0401138 	1300473080 364033 3640.33		SNODO SOSPENSIONE - BALL JOINT MOD. 1.8 t -> CH. 6087206
0381140 	1308760080 1317239080 1320756080 352166 3521.66		BRACCIO OSCILLANTE - TRACK CONTROL ARM MOD. 1.8 t -> CH. 6087206

**FIAT: DUCATO - 1994 > 2006 -**







RIF. OCAP OCAP REF.	RIF. ORIG O.E. NUMBER	NOTE REMARKS	MODELLO / DESCRIZIONE MODEL / DESCRIPTION
<b>0391140</b> 	<b>1320755080</b> 1317238080 1308759080 352096 3520.96		BRACCIO OSCILLANTE - TRACK CONTROL ARM MOD. 1.8 t -> CH. 6087206
<b>0401451</b> 	<b>1331641080</b> 364054 3640.54		SNODO SOSPENSIONE - BALL JOINT MOD. 1.8 t - CH. 6087206 >
<b>0381451</b> 	<b>1339466080</b> 1331939080 3521J4 3521.J4		BRACCIO OSCILLANTE - TRACK CONTROL ARM MOD. 1.8 t - CH. 6087206 >
<b>0391451</b> 	<b>1339464080</b> 1331937080 3520N4 3520.N4		BRACCIO OSCILLANTE - TRACK CONTROL ARM MOD. 1.8 t - CH. 6087206 >
<b>1215176</b> 	-		SILENTBLOC CENTRALE CENTRAL BUSHING
<b>1215177</b> 	-		SILENTBLOC ESTREMO OUTER BUSHING
<b>0181602</b> 	<b>1300716080</b>		PUNTONE BARRA STABILIZZATRICE STABILIZER LINK



## FIAT: DUCATO - 1994 &gt; 2006 -

RIF. OCAP OCAP REF.	RIF. ORIG O.E. NUMBER	NOTE REMARKS	MODELLO / DESCRIZIONE MODEL / DESCRIPTION
<b>0181602-K</b> 	1300716080 (1) 15503811 (2) 1300721080 (3) 1300720080 (4)		KIT PUNTONE BARRA STABILIZZATRICE STABILIZER LINK KIT
<b>1215491</b> 	<b>1300720080</b>		GOMMINO PUNTONE BARRA STABILIZZATRICE RUBBER RING STABILIZER LINK

**FIAT: DUCATO - 2006 > -**









RIF. OCAP OCAP REF.	RIF. ORIG O.E. NUMBER	NOTE REMARKS	MODELLO / DESCRIZIONE MODEL / DESCRIPTION
<b>0282637</b> 	<b>381770</b> 77364009	M=16x1,5 RHT	TESTA STERZO TIE ROD END
<b>0292637</b> 	<b>381777</b> 77364253	M=16x1,5 RHT	TESTA STERZO TIE ROD END
<b>0602637</b> 	<b>4000SF *</b> 4000SG * 1341019080 * 1345854080 *	M=16x1,5 RHT	SNODO ASSIALE AXIAL JOINT
<b>0902637</b> 	<b>406686</b> 77364254		KIT CUFFIA STERZO STEERING BOOT KIT
<b>0402638</b> 	<b>364067</b> 50705629		SNODO SOSPENSIONE - ASSE ANTERIORE BALL JOINT - FRONT AXLE MOD. Q11-Q15-Q17L-Q17Q-Q20
<b>0382638</b> 	<b>3521P1</b> 1352225080		BRACCIO OSCILLANTE - ASSE ANTERIORE - INFERIORE TRACK CONTROL ARM FRONT AXLE - LOWER MOD. Q11-Q15-Q17L
<b>0392638</b> 	<b>3520S0</b> 1352227080		BRACCIO OSCILLANTE - ASSE ANTERIORE - INFERIORE TRACK CONTROL ARM FRONT AXLE - LOWER MOD. Q11-Q15-Q17L

## FIAT: DUCATO - 2006 &gt; -



RIF. OCAP OCAP REF.	RIF. ORIG O.E. NUMBER	NOTE REMARKS	MODELLO / DESCRIZIONE MODEL / DESCRIPTION
0382639 	3521P2 1352226080		BRACCIO OSCILLANTE - ASSE ANTERIORE - INFERIORE TRACK CONTROL ARM FRONT AXLE - LOWER MOD. Q17H-Q20
0392639 	3520S1 1352228080		BRACCIO OSCILLANTE - ASSE ANTERIORE - INFERIORE TRACK CONTROL ARM FRONT AXLE - LOWER MOD. Q17H-Q20
1215822 	-		SILENTBLOC CENTRALE - CENTRAL BUSHING
1215823 	-		SILENTBLOC ESTREMO - OUTER BUSHING
0182638 	1350658080 Z 1357572080 Z 5081N9 Z		STABILIZZATORE - ASSE ANTERIORE - STABILIZER LINK - FRONT AXLE
0503520 	1355449080 Z		STABILIZZATORE - ASSE POSTERIORE - STABILIZER LINK - REAR AXLE











**FIAT: SCUDO (220) - 1995 > 2006 -**

RIF. OCAP OCAP REF.	RIF. ORIG O.E. NUMBER	NOTE REMARKS	MODELLO / DESCRIZIONE MODEL / DESCRIPTION
<b>0280037</b> 	<b>405909</b> 9404059080 1306003080 4322906 3265974	M=14x1,5 RHT	TESTA STERZO - TIE ROD END
<b>0283815</b> 	<b>77362279</b>	M=14x1,5 RHT	TESTA STERZO - SERVOSTERZO 2004 > TIE ROD END - POWER STEERING - 2004 >
<b>0600918</b> 	<b>3812A4</b> 9566950880	M=14x1,5 RHT	SNODO ASSIALE - AXIAL JOINT
<b>0381184</b> 	<b>71737048</b> 1313084080 1333755080 1322664080 1317390080 1316736080		BRACCIO OSCILLANTE - TRACK CONTROL ARM
<b>0391184</b> 	<b>71737047</b> 1313083080 1333754080 1322663080 1317389080 1316735080		BRACCIO OSCILLANTE - TRACK CONTROL ARM
<b>1215173</b> 	-		SILENBLOCK CENTRALE - CENTRAL BUSHING
<b>1215174</b> 	-		SILENBLOCK ESTREMO - DX OUTER BUSHING - RH
<b>1215175</b> 	-		SILENBLOCK ESTREMO - SX OUTER BUSHING - LH

## FIAT: SCUDO (220) - 1995 &gt; 2006 -



RIF. OCAP OCAP REF.	RIF. ORIG O.E. NUMBER	NOTE REMARKS	MODELLO / DESCRIZIONE MODEL / DESCRIPTION
<b>0181322-K</b> 	<b>1308664080 *</b> 15503811 * 1311025080 * 1313056080 * 508735 *		KIT PUNTONE BARRA STABILIZZATRICE STABILIZER LINK KIT
<b>0181322</b> 	<b>508735</b>		PUNTONE BARRA STABILIZZATRICE STABILIZER LINK

**FIAT: SCUDO (270) - 2007 > -**

RIF. OCAP OCAP REF.	RIF. ORIG O.E. NUMBER	NOTE REMARKS	MODELLO / DESCRIZIONE MODEL / DESCRIPTION
<b>0282733</b> 	<b>381773</b> 9403817738	M=14x1,5 RHT	TESTA STERZO - TIE ROD END
<b>0602733</b> 	<b>3812F0</b> 1497552080 1401381380	M=14x1,5 RHT	SNODO ASSIALE STERZO AXIAL JOINT
<b>1211477</b> 	<b>406683 *</b> 9404066838 *		CUFFIA STERZO STEERING GAITER
<b>0902733</b> 	<b>406683</b> 9404066838		KIT CUFFIA STERZO STEERING GAITER KIT
<b>0382734</b> 	<b>3521N9</b> 1497407080		BRACCIO OSCILLANTE TRACK CONTROL ARM
<b>0392734</b> 	<b>3520R8</b> 1497408080		BRACCIO OSCILLANTE TRACK CONTROL ARM
<b>1215646</b> 			SILENTBLOCK ESTREMO - DX OUTER BUSHING - RH
<b>1215647</b> 			SILENTBLOCK ESTREMO - SX OUTER BUSHING - LH









## FIAT: SCUDO (270) - 2007 &gt; -

RIF. OCAP OCAP REF.	RIF. ORIG O.E. NUMBER	NOTE REMARKS	MODELLO / DESCRIZIONE MODEL / DESCRIPTION
<b>1215870</b> 			SILENTBLOCK CENTRALE CENTRAL BUSHING
<b>0502735</b> 	<b>508756</b> 1400099680		STABILIZZATORE - ASSE ANTERIORE STABILIZER LINK - FRONT AXLE

**FORD: TRANSIT - 1992 > 2000 -**







RIF. OCAP OCAP REF.	RIF. ORIG O.E. NUMBER	NOTE REMARKS	MODELLO / DESCRIZIONE MODEL / DESCRIPTION
<b>0281725</b> 	<b>10391031</b> 1047145 6517364 6687191	M=16X1,5 RHT	TESTA STERZO TIE ROD END
<b>0601726</b> 	<b>68699511</b>	M=16x1,5 RHT	SNODO ASSIALE AXIAL JOINT
<b>1211073</b> 	<b>61600701</b>		CUFFIA STERZO - STERZO MANUALE STEERING BOOT - MANUAL STEERING
<b>1211165</b> 	<b>6869950</b>		CUFFIA STERZO - SERVOSTERZO STEERING BOOT- POWER STEERING
<b>0401127</b> 	<b>1055194</b>		SNODO SOSPENSIONE - INFERIORE BALL JOINT - LOWER
<b>0401127-K</b> 	-		KIT SNODO SOSPENSIONE - INFERIORE BALL JOINT KIT - LOWER
<b>0782751</b> 	<b>6608830</b>		BRACCIO OSCILLANTE - ASSE ANTERIORE INFERIORE TRACK CONTROL ARM - FRONT AXLE LOWER

## FORD: TRANSIT - 1992 &gt; 2000 -

RIF. OCAP OCAP REF.	RIF. ORIG O.E. NUMBER	NOTE REMARKS	MODELLO / DESCRIZIONE MODEL / DESCRIPTION
0792751 	6608832		BRACCIO OSCILLANTE - ASSE ANTERIORE INFERIORE TRACK CONTROL ARM - FRONT AXLE LOWER
1215877 	6608818		SILENBLOC CENTRALE CENTRAL BUSHING
1215878 	6517356		SILENBLOC CENTRALE - ESTERNO CENTRAL - OUTER BUSHING
0101724-K 	- 6150970 (1) 6150971 (2) 1481465 (3) 1631619 (4) 1549071 (5)		KIT PUNTONE BARRA STABILIZZATRICE STABILIZER LINK KIT
0181724 	6150970		PUNTONE BARRA STABILIZZATRICE STABILIZER LINK
0191724 	6150971		PUNTONE BARRA STABILIZZATRICE STABILIZER LINK

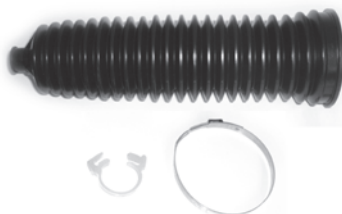





**FORD: TRANSIT - 2000 > 2013 -**

RIF. OCAP OCAP REF.	RIF. ORIG O.E. NUMBER	NOTE REMARKS	MODELLO / DESCRIZIONE MODEL / DESCRIPTION
<b>0283867</b> 	<b>1138275</b> 4047091	M=16x1,5 RHT	TESTA STERZO TIE ROD END
<b>0683868</b> 	<b>4059924</b>	M=16x1,5 RHT	SNODO ASSIALE AXIAL JOINT
<b>0693868</b> 	<b>4059923</b>	M=16x1,5 RHT	SNODO ASSIALE AXIAL JOINT
<b>0983868</b> 	<b>4059922</b>		KIT CUFFIA STERZO STEERING BOOT KIT
<b>0993868</b> 	<b>4059921</b>		KIT CUFFIA STERZO STEERING BOOT KIT
<b>0403869</b> 	<b>4381927</b> 4173761 4120734		SNODO SOSPENSIONE - ASSE ANTERIORE BALL JOINT - FRONT AXLE
<b>0403867</b> 	<b>1417351</b> 1451917 1763713 1817754 KT6C113K209AA		SNODO SOSPENSIONE ASSE ANTERIORE BALL JOINT - FRONT AXLE VEICOLI CARICO MAGGIORATO FOR VEHICLES WITH INCREASED AXLE LOAD

## FORD: TRANSIT - 2000 &gt; 2013 -

RIF. OCAP OCAP REF.	RIF. ORIG O.E. NUMBER	NOTE REMARKS	MODELLO / DESCRIZIONE MODEL / DESCRIPTION
<b>0783869</b> 	<b>4540774</b> 4372130 4164518 4140393 4042022		BRACCIO OSCILLANTE - ASSE ANTERIORE TRACK CONTROL ARM - FRONT AXLE
<b>0793869</b> 	<b>4540775</b> 4372131 4164522 4140394 4042023		BRACCIO OSCILLANTE - ASSE ANTERIORE TRACK CONTROL ARM - FRONT AXLE
<b>0783867</b> 	<b>1553239</b> 1371231 1438253 1495683 6C113A052BB		BRACCIO OSCILLANTE ASSE ANTERIORE TRACK CONTROL ARM - FRONT AXLE VEICOLI CARICO MAGGIORATO FOR VEHICLES WITH INCREASED AXLE LOAD
<b>0793867</b> 	<b>1553250</b> 1371228 1438254 1495684 6C113A053BB		BRACCIO OSCILLANTE ASSE ANTERIORE TRACK CONTROL ARM - FRONT AXLE VEICOLI CARICO MAGGIORATO FOR VEHICLES WITH INCREASED AXLE LOAD
<b>1215677</b> 	-		SILENBLOC CENTRALE CENTRAL BUSHING
<b>1215678</b> 	<b>4131788</b>		SILENBLOC ESTREMO OUTER BUSHING
<b>0903870</b> 	- 3736028 (1) 4041494 (2) 3933468 (3)		KIT STABILIZZATORE - ASSE ANTERIORE STABILIZER LINK KIT - FRONT AXLE SERIE - SERIES: 260/280/300

**FORD: TRANSIT - 2000 > 2013 -**

RIF. OCAP OCAP REF.	RIF. ORIG O.E. NUMBER	NOTE REMARKS	MODELLO / DESCRIZIONE MODEL / DESCRIPTION
<b>0503870</b>  	<b>3736028</b>		STABILIZZATORE - ASSE ANTERIORE STABILIZER LINK - FRONT AXLE SERIE - SERIES: 260/208/300
<b>0503254</b>  	<b>4519467</b> 1495685 1763714		STABILIZZATORE - ASSE ANTERIORE STABILIZER LINK - FRONT AXLE SERIE - SERIES: 330/350
<b>0503871</b>  	<b>4042068</b>		STABILIZZATORE - ASSE POSTERIORE SOLO MOD. RUOTE GEMELLATE > 08/2001 STABILIZER LINK - REAR AXLE ONLY MOD. TWIN WHEEL > 08/2001
<b>0503872</b>  	<b>4440885</b>		STABILIZZATORE - ASSE POSTERIORE SOLO MOD. RUOTE GEMELLATE 08/2001 > STABILIZER LINK - REAR AXLE ONLY MOD. TWIN WHEEL 08/2001 >

## FORD: TRANSIT - 08/2013 &gt; -









RIF. OCAP OCAP REF.	RIF. ORIG O.E. NUMBER	NOTE REMARKS	MODELLO / DESCRIZIONE MODEL / DESCRIPTION
0283867 	1138275 4047091	M=16x1,5 RHT	TESTA STERZO TIE ROD END
0603867 	1763991		SNODO ASSIALE STERZO AXIAL JOINT
0403869 	4381927 4173761 4120734		SNODO SOSPENSIONE - ASSE ANTERIORE BALL JOINT - FRONT AXLE
0783868 	1877332		BRACCIO OSCILLANTE - ASSE ANTERIORE TRACK CONTROL ARM - FRONT AXLE
0793868 	1877334		BRACCIO OSCILLANTE - ASSE ANTERIORE TRACK CONTROL ARM - FRONT AXLE
1216245 	BK213A262AC		SILENTBLOCK CENTRALE CENTRAL BUSHING
1216246 	BK213059A		SILENTBLOCK ESTREMO OUTER BUSHING



**FORD: TRANSIT - 08/2013 > -**

RIF. OCAP OCAP REF.	RIF. ORIG O.E. NUMBER	NOTE REMARKS	MODELLO / DESCRIZIONE MODEL / DESCRIPTION
<b>0403867</b> 	<b>1417351</b> 1451917 1763713 1817754 KT6C113K209AA		SNODO SOSPENSIONE ASSE ANTERIORE BALL JOINT - FRONT AXLE VEICOLI CARICO MAGGIORATO FOR VEHICLES WITH INCREASED AXLE LOAD
<b>0783870</b> 	<b>1903526</b>		BRACCIO OSCILLANTE ASSE ANTERIORE VEICOLI CARICO MAGGIORATO TRACK CONTROL ARM - FRONT AXLE FOR VEHICLES WITH INCREASED AXLE LOAD
<b>0793870</b> 	<b>1903527</b>		BRACCIO OSCILLANTE ASSE ANTERIORE VEICOLI CARICO MAGGIORATO TRACK CONTROL ARM - FRONT AXLE FOR VEHICLES WITH INCREASED AXLE LOAD
<b>1216245</b> 	<b>BK213A262AC</b>		SILENTBLOCK CENTRALE CENTRAL BUSHING
<b>1216246</b> 	<b>BK213059A</b>		SILENTBLOCK ESTREMO OUTER BUSHING
<b>0503254</b> 	<b>4519467</b> 1495685 1763714		STABILIZZATORE - ASSE ANTERIORE STABILIZER LINK - FRONT AXLE



## IVECO: DAILY 30.8 &gt; 59.12 -

RIF. OCAP OCAP REF.	RIF. ORIG O.E. NUMBER	NOTE REMARKS	MODELLO / DESCRIZIONE MODEL / DESCRIPTION
0280515 	1903652	L=80  M=16x1,5 RHT	TESTA STERZO TIE ROD END
0287552 	42534911	L=80  M=16x1,5 RHT	TESTA STERZO TIE ROD END 35S9/10/11/12/13/15 35C9/10/11/12/13/15 40C13-50C11/13/15 65C11/13/15-29L10/12
0600516 	9983325	L=310  M=16x1,5 RHT	SNODO ASSIALE AXIAL JOINT
0606927 	-	M=16x1,5 RHT	SNODO ASSIALE AXIAL JOINT
0280517 	93802209	L=72  M=20x1,5 RHT	TESTA BARRA SOSPENSIONE ASSE ANTERIORE SUSPENSION JOINT - FRONT AXLE
0286616 	500337201	L=80  M=20x1,5 RHT	TESTA BARRA SOSPENSIONE ASSE ANTERIORE SUSPENSION JOINT - FRONT AXLE MOD. RESTYLING - NEW DAILY TURBODAILY - DAILY CNG
0400518 	93802242	M=20x1,5 RHT	SNODO SOSPENSIONE ASSE ANTERIORE BALL JOINT FRONT AXLE ECCETTO EXCEPT MOD. 35S9/10/11/12/13/15 35C9/10/11/12/13/15 - 29L10/12
0407249 	-		SNODO SOSPENSIONE - BALL JOINT MOD. 35S9/10/11/12/13/15 35C9/10/11/12/13/15 29L10/12

**IVECO: DAILY 30.8 > 59.12 -**

RIF. OCAP OCAP REF.	RIF. ORIG O.E. NUMBER	NOTE REMARKS	MODELLO / DESCRIZIONE MODEL / DESCRIPTION
<b>0787249</b> 	<b>500379802</b> 42551297		BRACCIO OSCILLANTE ASSE ANTERIORE SUPERIORE - UPPER TRACK CONTROL ARM FRONT AXLE- MOD. 35S9 /10/11/12/13/15 35C9 /10/11/12/13/15 - 29L10 /12
<b>0797249</b> 	<b>500379801</b> 42551296		BRACCIO OSCILLANTE ASSE ANTERIORE SUPERIORE - UPPER TRACK CONTROL ARM FRONT AXLE- MOD. 35S9 /10/11/12/13/15 35C9 /10/11/12/13/15 - 29L10 /12
<b>0407250</b> 	-		SNODO SOSPENSIONE BRACCIO OSCILLANTE ANTERIORE INFERIORE TRACK CONTROL ARM BALL JOINT FRONT LOWER MOD.: 35S9 /10/11/12/13/15 35C9 /10/11/12/13/15 - 29L10 /12
<b>0787250</b> 	<b>500334716</b> 42551290		BRACCIO OSCILLANTE ASSE ANTERIORE INFERIORE - LOWER TRACK CONTROL ARM FRONT AXLE- MOD. 35S9 /10/11/12/13/15 35C9 /10/11/12/13/15 - 29L10 /12
<b>0797250</b> 	<b>500334717</b> 42551289		BRACCIO OSCILLANTE ASSE ANTERIORE SUPERIORE - UPPER TRACK CONTROL ARM FRONT AXLE- MOD. 35S9 /10/11/12/13/15 35C9 /10/11/12/13/15 - 29L10 /12
<b>1215953</b> 	<b>504039506</b>		SILENTBLOC BRACCI OSCILLANTI CONTROL ARMS BUSHING MOD: 35S9 /10/11/12/13/15 35C9/10/11/12/13/15 29L10 /12

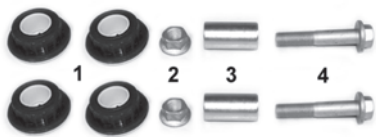
## IVECO: DAILY 30.8 &gt; 59.12 -







RIF. OCAP OCAP REF.	RIF. ORIG O.E. NUMBER	NOTE REMARKS	MODELLO / DESCRIZIONE MODEL / DESCRIPTION
<b>0903144</b> 	- 504039506 (1) 16750635 (2) 500339201 (3) 500317413 (4)		KIT RIPARAZIONE BRACCI OSCILLANTI IN LAMIERA TRACK CONTROL ARM SHEET METAL REPAIRING KIT MOD. : 35S9 /10/11/12/13/15 - 35C9 /10/11/12/13/15 - 29L10 /12
<b>1215269</b> 	<b>93807641</b>		SILENTBLOC BRACCIO OSCILLANTE SUPERIORE - ASSE ANTERIORE - UPPER CONTROL ARM BUSHING - FRONT AXLE - MOD. RESTYLING: 49-10 - NEW DAILY: 30-8 > 35-12 - TURBODAILY: 30-10 > 35-12 - DIAM. 32 mm.
<b>1215271</b> 	<b>93810239</b>		SILENTBLOC BRACCIO OSCILLANTE SUPERIORE - ASSE ANTERIORE - UPPER CONTROL ARM BUSHING - FRONT AXLE - MOD. RESTYLING: 49-10 - NEW DAILY: 30-8 > 35-12 - TURBODAILY: 30-10 > 35-12 - DIAM. 37 mm.
<b>1215270</b> 	<b>93807640</b>		SILENTBLOC BRACCIO OSCILLANTE INFERIORE - ASSE ANTERIORE - LOWER CONTROL ARM BUSHING - FRONT AXLE - MOD. RESTYLING: 49-10 - NEW DAILY: 30-8 > 35-12 - TURBODAILY: 30-10 > 35-12 - DIAM. 29 mm.
<b>0587871</b> 	<b>500383975</b>		STABILIZZATORE ASSE ANTERIORE STABILIZER LINK - FRONT AXLE MOD: 35S9/10/11/12/13/15 29L10
<b>0597871</b> 	<b>500383976</b>		STABILIZZATORE ASSE ANTERIORE STABILIZER LINK - FRONT AXLE MOD: 35S9/10/11/12/13/15 29L10









**IVECO: DAILY III - 05/2006 > -**

RIF. OCAP OCAP REF.	RIF. ORIG O.E. NUMBER	NOTE REMARKS	MODELLO / DESCRIZIONE MODEL / DESCRIPTION
<b>0287552</b> 	<b>42534911</b>	L=80  M=16x1,5 RHT	TESTA STERZO TIE ROD END
<b>0602749</b> 	<b>2992593</b>	M=16x1,5 RHT	SNODO ASSIALE AXIAL JOINT
<b>0607552</b> 	<b>42532977</b> 99463268	L=348 M=16x1,5 RHT	SNODO ASSIALE AXIAL JOINT
<b>0902749</b> 	<b>2992592</b>		KIT CUFFIA STERZO STEERING BOOT KIT
<b>1211482</b> 	-		CUFFIA STERZO STEERING BOOT
<b>0280517</b> 	<b>93802209</b>	L=72  M=20x1,5 RHT	TESTA BARRA SOSPENSIONE ASSE ANTERIORE SUSPENSION JOINT - FRONT AXLE
<b>0407893</b> 	<b>504212586</b>	M=18x1,5 RHT	SNODO SOSPENSIONE ASSE ANTERIORE BALL JOINT FRONT AXLE
<b>0407894</b> 	<b>5801378064</b>		SNODO SOSPENSIONE ASSE ANTERIORE MOD. 90 Q.li BALL JOINT FRONT AXLE mod. 9t





## LDV: MAXSUS - 2005 &gt; -

RIF. OCAP OCAP REF.	RIF. ORIG O.E. NUMBER	NOTE REMARKS	MODELLO / DESCRIZIONE MODEL / DESCRIPTION
0405069 	542410025 542410018		SNODO SOSPENSIONE ASSE ANTERIORE - INFERIORE BALL JOINT FRONT AXLE - LOWER
0385072 	542150012		BRACCIO OSCILLANTE ASSE ANTERIORE - INFERIORE TRACK CONTROL ARM FRONT AXLE LOWER
0395072 	542150011		BRACCIO OSCILLANTE ASSE ANTERIORE - INFERIORE TRACK CONTROL ARM FRONT AXLE LOWER
0585068 	542180024		STABILIZZATORE - ASSE ANTERIORE STABILIZER LINK - FRONT AXLE
0595068 	542180023		STABILIZZATORE - ASSE ANTERIORE STABILIZER LINK - FRONT AXLE
0858054 	542180020		BARRA STABILIZZATRICE - ASSE ANTERIORE STABILIZING BAR - FRONT AXLE

**MERCEDES: MB100 > MB180 - 1988 > -**

RIF. OCAP OCAP REF.	RIF. ORIG O.E. NUMBER	NOTE REMARKS	MODELLO / DESCRIZIONE MODEL / DESCRIPTION
<p><b>0502258</b></p>  <p><b>0182261</b> M=18x1,5 RHT <b>0192258</b> M=18x1,5 LHT</p>	<b>6313300303</b>	L=260	BARRA STERZO TIE ROD
<p><b>0182261</b></p> 	<b>6313380310</b> 0004606548	L=95  M=18x1,5 RHT	TESTA STERZO TIE ROD END
<p><b>0192258</b></p> 	<b>6313380410</b>	L=95  M=18x1,5 LHT	TESTA STERZO TIE ROD END
<p><b>0502259</b></p>  <p><b>0182259</b> M=24x1,5 RHT</p>	<b>6313300603</b>	L=653	BARRA STERZO TIE ROD
<p><b>0182259</b></p> 	<b>6313300535</b>	L=105  M=24x1,5 RHT	TESTA STERZO TIE ROD END
<p><b>0502260</b></p>  <p><b>0182260</b> M=20x1,5 RHT <b>0192260</b> M=20x1,5 LHT</p>	<b>6313300703</b> 6313300503	L=265	BARRA STERZO TIE ROD
<p><b>0182260</b></p> 	<b>0004607248</b> 0013304835 4603301235	L=95  M=20x1,5 RHT	TESTA STERZO TIE ROD END

## MERCEDES: MB100 &gt; MB180 - 1988 &gt; -



RIF. OCAP OCAP REF.	RIF. ORIG O.E. NUMBER	NOTE REMARKS	MODELLO / DESCRIZIONE MODEL / DESCRIPTION
<b>0192260</b> 	<b>6313300435</b>	L=100  M=20x1,5 LHT	TESTA STREZO TIE ROD END
<b>0502261</b>   <b>0182261</b> M=18x1,5 RHT	<b>6314600705</b>	L=1223	BARRA STERZO TIE ROD
<b>0182261</b> 	<b>6313380310</b> 0004606548	L=95  M=18x1,5 RHT	TESTA STERZO TIE ROD END
<b>0402159</b> 	<b>0003200028</b> 0003200128 6083200028 6083200128 6313200028 6313200228	M=16x1,5 RHT	SNODO SOSPENSIONE BALL JOINT









**MERCEDES: SPRINTER - 1995 > 05/2006 -**

RIF. OCAP OCAP REF.	RIF. ORIG O.E. NUMBER	NOTE REMARKS	MODELLO / DESCRIZIONE MODEL / DESCRIPTION
<b>0501503</b>   <b>0281503</b> M=16x1,5 RHT	<b>9014600205</b> 2D0422803		BARRA STERZO - SCATOLA GUIDA TIE ROD - STEERING BOX
<b>0281503</b> 	<b>9014600348</b> 9014600048 9014600148 2D0422811	L=76  M=16x1,5 RHT	TESTA STERZO - SCATOLA GUIDA TIE ROD END - STEERING BOX
<b>0601504</b> 	<b>9014600155</b> 9014600255 9014600455 2D0422803	M=16x1,5 RHT	SNODO ASSIALE - SCATOLA GUIDA AXIAL JOINT - STEERING BOX
<b>1211400</b> 	<b>2D0422831</b>		CUFFIA STERZO STEERING BOOT
<b>0901504</b> 	<b>9014605500</b> 2D0498831		KIT CUFFIA STERZO STEERING BOOT KIT
<b>0401505</b> 	<b>9013331227</b> 9013331127 9013331027 9013330727 9013330627 2D0407361A	M=20x1,5	SNODO SOSPENSIONE ASSE ANTERIORE BALL JOINT FRONT AXLE
<b>0781505</b> 	<b>9013302507</b> 9013301907 2D0407022B 2D0407022		BRACCIO OSCILLANTE - ANTERIORE TRACK CONTROL ARM - FRONT







## MERCEDES: SPRINTER - 1995 &gt; 05/2006 -

RIF. OCAP OCAP REF.	RIF. ORIG O.E. NUMBER	NOTE REMARKS	MODELLO / DESCRIZIONE MODEL / DESCRIPTION
0791505 	9013301807 2D0407021B 2D0407021		BRACCIO OSCILLANTE - ANTERIORE TRACK CONTROL ARM - FRONT
1215705 	9013330214 2D0407140		SILENTBLOC - BUSHING
0581514 	9013200389 2D0411052		STABILIZZATORE - ASSE ANTERIORE CON SILENTBLOC STABILIZER LINK- FRONT AXLE WITH BUSHING
0591514 	9013200289 2D0411051		STABILIZZATORE - ASSE ANTERIORE CON SILENTBLOC STABILIZER LINK - FRONT AXLE WITH BUSHING
0502368 	9013200689	L=300	STABILIZZATORE - ASSE POSTERIORE STABILIZER LINK - REAR AXLE
0502379 	9013200589	L=230	STABILIZZATORE - ASSE POSTERIORE STABILIZER LINK - REAR AXLE
0104151 	2D0511329 9013200089	L=95	STABILIZZATORE - ASSE POSTERIORE STABILIZER LINK - REAR AXLE

**MERCEDES: SPRINTER - 06/2006 > -**





RIF. OCAP OCAP REF.	RIF. ORIG O.E. NUMBER	NOTE REMARKS	MODELLO / DESCRIZIONE MODEL / DESCRIPTION
<b>0282717</b> 	<b>9064600048</b>	M=16x1,5 RHT	TESTA STERZO TIE ROD END
<b>0602741-K</b> 	<b>9064600055</b>		KIT SNODO ASSIALE AXIAL JOINT KIT
<b>0602741</b> 	-	M=16x1,5 RHT	SNODO ASSIALE AXIAL JOINT
<b>0902741</b> 	<b>9064600096</b>		KIT CUFFIA STERZO STEERING BOOT KIT
<b>1211481</b> 	-		CUFFIA STERZO STEERING BOOT KIT
<b>0402742</b> 	-		SNODO SOSPENSIONE - ASSE ANTERIORE BALL JOINT - FRONT AXLE
<b>0782742</b> 	<b>2E0407152M</b>		BRACCIO OSCILLANTE - ASSE ANTERIORE TRACK CONTROL ARM - FRONT AXLE

## MERCEDES: SPRINTER - 06/2006 &gt; -



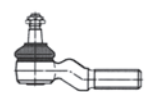
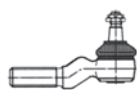



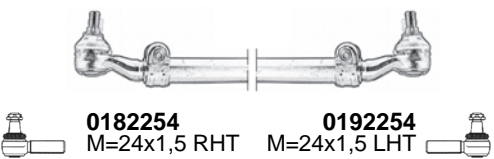

RIF. OCAP OCAP REF.	RIF. ORIG O.E. NUMBER	NOTE REMARKS	MODELLO / DESCRIZIONE MODEL / DESCRIPTION
0792742 	9063304007		BRACCIO OSCILLANTE - ASSE ANTERIORE TRACK CONTROL ARM - FRONT AXLE
1215874 	9063330014		SILENTBLOC - BUSHING
0582743 	9063201889		STABILIZZATORE - ASSE ANTERIORE STABILIZER LINK - FRONT AXLE
0592743 	9063201789		STABILIZZATORE - ASSE ANTERIORE STABILIZER LINK - FRONT AXLE
0502744 	6013201389		STABILIZZATORE - ASSE POSTERIORE STABILIZER LINK - REAR AXLE
1215817 	6013210350		SILENTBLOC STABILIZZATORE - ASSE POSTERIORE STABILIZER LINK BUSHING - REAR AXLE



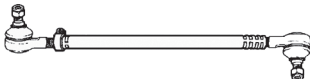
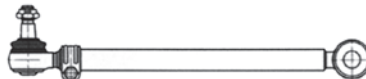

MERCEDES: T1 (601-602) - >1996 - T1/TN (407>410) - >1995

RIF. OCAP OCAP REF.	RIF. ORIG O.E. NUMBER	NOTE REMARKS	MODELLO / DESCRIZIONE MODEL / DESCRIPTION
<p><b>0502252</b></p>  <p><b>0182252</b> M=16x1,5 RHT    <b>0192252</b> M=16x1,5 LHT</p>	<b>6083300303</b>	L=510	BARRA STERZO TIE ROD MOD.: T1 207D
<p><b>0182252</b></p> 	<b>6083330027</b>	L=90  M=16x1,5 RHT	TESTA STERZO TIE ROD END MOD.: T1 207D
<p><b>0192252</b></p> 	<b>6083380110</b>	L=90  M=16x1,5 LHT	TESTA STERZO TIE ROD END MOD.: T1 207D
<p><b>0502253</b></p>  <p><b>0180727</b> M=20x1,5 RHT</p>	<b>6023300403</b> 6023300003 6023300103 6023300303	L=1335	BARRA STERZO TIE ROD
<p><b>0180727</b></p> 	<b>6013300435</b> 6013300635 6013305335	L=95  M=20x1,5 RHT	TESTA STERZO TIE ROD END
<p><b>0190727</b></p> 	<b>6013300535</b> 6013300735 6013305235	L=95  M=20x1,5 LHT	TESTA STERZO TIE ROD END
<p><b>0502254</b></p>  <p><b>0182254</b> M=24x1,5 RHT    <b>0192254</b> M=24x1,5 LHT</p>	<b>6023300903</b> 6023301003 6023305303 6023305403	L=1345	BARRA STERZO TIE ROD MOD.: T1







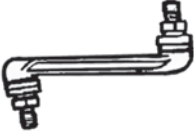

## MERCEDES: T1 (601-602) - &gt;1996 - T1/TN (407&gt;410) - &gt;1995

RIF. OCAP OCAP REF.	RIF. ORIG O.E. NUMBER	NOTE REMARKS	MODELLO / DESCRIZIONE MODEL / DESCRIPTION
<b>0182254</b> 	<b>6023300035</b> 6023305535 6023305835	L=115  M=24x1,5 RHT	TESTA STERZO TIE ROD END MOD.: T1
<b>0192254</b> 	<b>6023300135</b> 6023305435 6023305735 6083305535 6083305735	L=115  M=24x1,5 LHT	TESTA STERZO TIE ROD END MOD.: T1
<b>0502255</b> 	<b>6083300403</b> 5829067053	L=312	BARRA STERZO TIE ROD MOD.: T1 (601)
<b>0502256</b> 	<b>6084600105</b>	L=1135	BARRA STERZO TIE ROD MOD.: T1 (601)
<b>0500730</b>  <b>0180730</b> 	<b>3094600305</b> 3094602905 3094603005 3094603105 3094603205 6014600005 6014600105 6014600205 6014600305	L=470	BARRA STERZO TIE ROD MOD.: T1
<b>0502257</b>  <b>0180730</b>  M=22x1,5 RHT <b>0190731</b>  M=22x1,5 LHT	<b>6014600505</b> 6014600605 6014600705 6014600805 6014600905 6014601005 6014601105 6014601205 6014601305 6014601505	L=450	BARRA STERZO TIE ROD
<b>0180730</b> 	<b>0004604148</b> 0004608548 3103301335	L=95  M=22x1,5 RHT	TESTA STERZO TIE ROD END



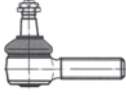
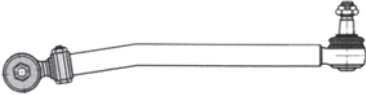

**MERCEDES: T1 (601-602) - >1996 - T1/TN (407>410) - >1995**

RIF. OCAP OCAP REF.	RIF. ORIG O.E. NUMBER	NOTE REMARKS	MODELLO / DESCRIZIONE MODEL / DESCRIPTION
<b>0190731</b>  	<b>0004608748</b> 0004608648 0004604648 0004604248	L=250  M=22x1,5 LHT	TESTA STERZO TIE ROD END
<b>0402159</b>  	<b>0003200028</b> 0003200128 6083200028 6083200128 6313200028 6313200228	M=16x1,5 RHT	SNODO SOSPENSIONE BALL JOINT MOD.: T1 (601) 207D
<b>0501347</b>  	<b>6014300535</b>		STABILIZZATORE STABILIZER LINK MOD. T1

## MERCEDES: T2/LN1 (507 &gt; 814) - 1986 &gt; - 1994

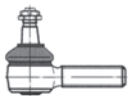
RIF. OCAP OCAP REF.	RIF. ORIG O.E. NUMBER	NOTE REMARKS	MODELLO / DESCRIZIONE MODEL / DESCRIPTION
<b>0507659</b>   <b>0186613</b>	<b>6704602605</b> 6704602705	L=495 T=32	BARRA STERZO TIE ROD MOD.: 809-811-814
<b>0186613</b> 	<b>0003309335</b> 0003301435 0003301535 0003307135 0003309535 0003382129	L=105  M=28x1,5 RHT	TESTA STERZO TIE ROD END MOD.: 809-811-814
<b>0507960</b>   <b>0187560</b> M=24x1,5 RHT	<b>6684602105</b> 6684602205	L=495 T=28	BARRA STERZO TIE ROD MOD.: 507-508-510-609-611-709-711-714
<b>0187560</b> 	<b>0013301435</b> 0003301035 0003381610 0013301235 0003301135 0003301635	L=95 M=24x1,5 RHT	TESTA STERZO TIE ROD END MOD.: 507-508-510-609-611-709-711-714
<b>0507624</b>   <b>0186613</b> M=28x1,5 RHT	<b>6704602805</b> 6704602905	L=495 T=32	BARRA STERZO TIE ROD MOD.: 709-711-714-809-811-814
<b>0186613</b> 	<b>0003309335</b> 0003301435 0003301535 0003307135 0003309535 0003382129	L=105  M=28x1,5 RHT	TESTA STERZO TIE ROD END MOD.: 709-711-714-809-811-814
<b>0507826</b>   <b>0187560</b> M=24x1,5 RHT	<b>6684602305</b> 6684602405	L=495 T=28	BARRA STERZO TIE ROD MOD.: 507-508-510-609-611-709-711-714

MERCEDES: T2/LN1 (507 > 814) - 1986 > - 1994

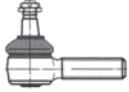
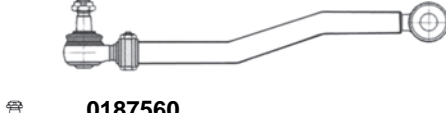
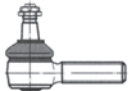

RIF. OCAP OCAP REF.	RIF. ORIG O.E. NUMBER	NOTE REMARKS	MODELLO / DESCRIZIONE MODEL / DESCRIPTION
<b>0187560</b> 	<b>0013301435</b> 0003301035 0003381610 0013301235 0003301135 0003301635	L=95 M=24x1,5 RHT	TESTA STERZO TIE ROD END MOD.: 507-508-510-609-611-709-711-714
<b>0507830</b>  <b>0186613</b> M=28x1,5 RHT	<b>6704600805</b> 6704601205 6704601605 6704602005	L=505 T=32	BARRA STERZO TIE ROD MOD.: 809-811-814
<b>0186613</b> 	<b>0003309335</b> 0003301435 0003301535 0003307135 0003309535 0003382129	L=105  M=28x1,5 RHT	TESTA STERZO TIE ROD END MOD.: 809-811-814
<b>0507660</b>  <b>0187560</b> M=24x1,5 RHT	<b>6684600905</b> 6684600505 6684600705 6684601105	L=505 T=28	BARRA STERZO TIE ROD MOD.: 507-508-510-609-611-709
<b>0187560</b> 	<b>0013301435</b> 0003301035 0003381610 0013301235 0003301135 0003301635	L=95 M=24x1,5 RHT	TESTA STERZO TIE ROD END MOD.: 507-508-510-609-611-709
<b>0507656</b>  <b>0187560</b> M=24x1,5 RHT	<b>6684601905</b> 6684601705 6684601505	L=505 T=28	BARRA STERZO TIE ROD MOD.: 609-611-668-669-709-711-714
<b>0187560</b> 	<b>0013301435</b> 0003301035 0003381610 0013301235 0003301135 0003301635	L=95 M=24x1,5 RHT	TESTA STERZO TIE ROD END MOD.: 609-611-668-669-709-711-714









## MERCEDES: T2/LN1 (507 &gt; 814) - 1986 &gt; - 1994

RIF. OCAP OCAP REF.	RIF. ORIG O.E. NUMBER	NOTE REMARKS	MODELLO / DESCRIZIONE MODEL / DESCRIPTION
<b>0507898</b>   <b>0186613</b> M=28x1,5 RHT	<b>6704600905</b> 6704601805 6704602205	L=505 T=32	BARRA STERZO TIE ROD MOD.: 507-508-510-709-711-714-809-811-814
<b>0186613</b> 	<b>0003309335</b> 0003301435 0003301535 0003307135 0003309535 0003382129	L=105  M=28x1,5 RHT	TESTA STERZO TIE ROD END MOD.: 507-508-510-709-711-714-809-811-814
<b>0507831</b>   <b>0180730</b> M=22x1,5 RHT	<b>6674600705</b> 6674601005	L=505 T=26	BARRA STERZO TIE ROD MOD.: 507-508-510
<b>0501499</b>   <b>0180727</b> M=20x1,5 RHT <b>0190727</b> M=20x1,5 LHT 	<b>6673300603</b> 6673300503 6673300303 6673300403	L=1.600	BARRA STERZO TIE ROD MOD.: 507-508-510
<b>0180727</b> 	<b>6013300435</b> 6013300635 6013305335	L=95  M=20x1,5 RHT	TESTA STERZO TIE ROD END MOD.: 507-508-510
<b>0190727</b> 	<b>6013300535</b> 6013300735 6013305235	L=95  M=20x1,5 LHT	TESTA STERZO TIE ROD END MOD.: 507-508-510
<b>0507653</b>   <b>0186612</b> M=24x1,5 RHT <b>0196612</b> M=24x1,5 LHT 	<b>6693300403</b> 6693300503 6703300003 6703300103 6703300203 6703300303 6883300003 6883300103	L=1594 T=35	BARRA STERZO TIE ROD MOD.: 507-508-510 609D-611D-709D-711D-714D-809D 811D-814D

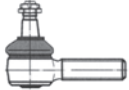

**MERCEDES: T2/LN1 (507 > 814) - 1986 > - 1994**

RIF. OCAP OCAP REF.	RIF. ORIG O.E. NUMBER	NOTE REMARKS	MODELLO / DESCRIZIONE MODEL / DESCRIPTION
<b>0186612</b>  	<b>0003301235</b> 0003307535 0003309735 0003309935 0003383429 0003383529 0023301335	L=106 M=24x1,5 RHT	TESTA STERZO TIE ROD END MOD.: 507-508-510 609D-611D-709D-711D-714D-809D 811D-814D
<b>0196612</b>  	<b>0003301335</b> 0003309835 0013300035 0083380029	L=106 M=24x1,5 LHT	TESTA STERZO TIE ROD END MOD.: 507-508-510 609D-611D-709D-711D-714D-809D 811D-814D







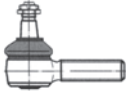
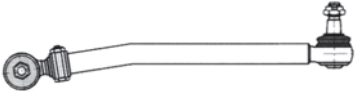
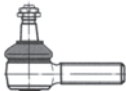

## MERCEDES: VARIO - 1996 &gt; -

RIF. OCAP OCAP REF.	RIF. ORIG O.E. NUMBER	NOTE REMARKS	MODELLO / DESCRIZIONE MODEL / DESCRIPTION
<b>0507960</b>  <b>0187560</b> M=24x1,5 RHT	<b>6684602105</b> 6684602205	L=495 T=28	BARRA STERZO TIE ROD MOD.: 512 D
<b>0187560</b> 	<b>0013301435</b> 0003301035 0003381610 0013301235 0003301135 0003301635	L=95 M=24x1,5 RHT	TESTA STERZO TIE ROD END MOD.: 512 D
<b>0507826</b>  <b>0187560</b> M=24x1,5 RHT	<b>6684602305</b> 6684602405	L=495 T=28	BARRA STERZO TIE ROD MOD.: 512 D
<b>0187560</b> 	<b>0013301435</b> 0003301035 0003381610 0013301235 0003301135 0003301635	L=95 M=24x1,5 RHT	TESTA STERZO TIE ROD END MOD.: 512 D
<b>0507608</b>  <b>0186613</b> M=28x1,5 RHT	<b>6674601605</b> 6674601805	L=504 T=34	BARRA STERZO TIE ROD MOD.: 512-612-613-615 MOD.: 810-812-813-814-815
<b>0186613</b> 	<b>0003309335</b> 0003301435 0003301535 0003307135 0003309535 0003382129	L=105  M=28x1,5 RHT	TESTA STERZO TIE ROD END MOD.: 809-811-814
<b>0507905</b>  <b>0186613</b> M=28x1,5 RHT	<b>6674601505</b> 6674601705	L=504 T=34	BARRA STERZO TIE ROD MOD.: 512-612-613-615-616 MOD.: 810-812-813-815

**MERCEDES: VARIO - 1996 > -**









RIF. OCAP OCAP REF.	RIF. ORIG O.E. NUMBER	NOTE REMARKS	MODELLO / DESCRIZIONE MODEL / DESCRIPTION
<b>0186613</b> 	<b>0003309335</b> 0003301435 0003301535 0003307135 0003309535 0003382129	L=105  M=28x1,5 RHT	TESTA STERZO TIE ROD END
<b>0507656</b>  <b>0187560</b> M=24x1,5 RHT	<b>6684601905</b> 6684601705 6684601505	L=505 T=28	BARRA STERZO TIE ROD MOD.: 512 D
<b>0187560</b> 	<b>0013301435</b> 0003301035 0003381610 0013301235 0003301135 0003301635	L=95 M=24x1,5 RHT	TESTA STERZO TIE ROD END MOD.: 512 D
<b>0507660</b>  <b>0187560</b> M=24x1,5 RHT	<b>6684600905</b> 6684600505 6684600705 6684601105	L=505 T=28	BARRA STERZO TIE ROD MOD.: 512 D
<b>0187560</b> 	<b>0013301435</b> 0003301035 0003381610 0013301235 0003301135 0003301635	L=95 M=24x1,5 RHT	TESTA STERZO TIE ROD END MOD.: 512 D

## MERCEDES: VITO - 1996 &gt; 2003 -







RIF. OCAP OCAP REF.	RIF. ORIG O.E. NUMBER	NOTE REMARKS	MODELLO / DESCRIZIONE MODEL / DESCRIPTION
<b>0501904</b>   <b>0281904</b> M=16x1,5 RHT	<b>6384600205</b>		BARRA STERZO TIE ROD
<b>0281904</b> 	<b>6384600048</b>	L=75  M=16x1,5 RHT	TESTA STERZO TIE ROD END
<b>0601905</b> 	<b>6384600255</b>	L=359  M=16x1,5 RHT	SNODO ASSIALE AXIAL JOINT
<b>1211400</b> 	<b>2D0422831</b>		CUFFIA STERZO STEERING BOOT
<b>0901504</b> 	<b>9014605500</b> 2D0498831		KIT CUFFIA STERZO STEERING BOOT KIT
<b>0401906</b> 	<b>6383330027</b>		SNODO SOSPENSIONE SUSPENSION JOIN
<b>0781906</b> 	<b>6383300110</b>		BRACCIO OSCILLANTE TRACK CONTROL ARM





**MERCEDES: VITO - 1996 > 2003 -**

RIF. OCAP OCAP REF.	RIF. ORIG O.E. NUMBER	NOTE REMARKS	MODELLO / DESCRIZIONE MODEL / DESCRIPTION
<b>0791906</b> 	<b>6383300010</b>		BRACCIO OSCILLANTE TRACK CONTROL ARM
<b>1215503</b> 	-		SILENTBLOCK CENTRALE CENTRAL BUSHING
<b>1215504</b> 	-		SILENTBLOCK ESTREMO OUTER BUSHING
<b>0581907</b> 	<b>6383230368</b>		STABILIZZATORE STABILIZER LINK
<b>0591907</b> 	<b>6383230268</b>		STABILIZZATORE STABILIZER LINK
<b>0584163</b> 	<b>6383230568</b>		STABILIZZATORE - ASSE ANTERIORE STABILIZER LINK - FRONT AXLE CH. 267541 >
<b>0594163</b> 	<b>6383230468</b>		STABILIZZATORE - ASSE ANTERIORE STABILIZER LINK - FRONT AXLE CH. 267541 >
<b>0504160</b> 	<b>6383260116</b>		STABILIZZATORE - ASSE POSTERIORE STABILIZER LINK - REAR AXLE







## MERCEDES: VITO - 2003 &gt; -

RIF. OCAP OCAP REF.	RIF. ORIG O.E. NUMBER	NOTE REMARKS	MODELLO / DESCRIZIONE MODEL / DESCRIPTION
0284249 	6384600048 6394600348 6394600548		TESTA STERZO - RHT M16x1,5 TIE ROD END - RHT M16x1,5
0294249 	6394600048		TESTA STERZO - RHT M16x1,5 TIE ROD END - RHT M16x1,5
0604250-K 	6394600055		KIT SNODO ASSIALE - RHT M16x1,5 AXIAL JOINT KIT - RHT M16x1,5
0604250 	-		SNODO ASSIALE - RHT M16x1,5 AXIAL JOINT - RHT M16x1,5
0404260 	-		SNODO SOSPENSIONE - ASSE ANTERIORE INFERIORE - CON KIT BALL JOINT - FRONT AXLE LOWER - WITH KIT
0784260 	6393300510		BRACCIO OSCILLANTE ASSE ANTERIORE - INFERIORE TRACK CONTROL ARM FONT AXLE - LOWER
0794260 	6393300410		BRACCIO OSCILLANTE ASSE ANTERIORE - INFERIORE TRACK CONTROL ARM FONT AXLE - LOWER





**MERCEDES: VITO - 2003 > -**

RIF. OCAP OCAP REF.	RIF. ORIG O.E. NUMBER	NOTE REMARKS	MODELLO / DESCRIZIONE MODEL / DESCRIPTION
<p><b>1215704</b></p> 	<b>6393330214</b>		SILENTBLOC - BUSHING
<p><b>0584262</b></p> 	<b>6393200189</b>		STABILIZZATORE - ASSE ANTERIORE STABILIZER LINK - FRONT AXLE
<p><b>0594262</b></p> 	<b>6393200089</b>		STABILIZZATORE - ASSE ANTERIORE STABILIZER LINK - FRONT AXLE

## NISSAN: INTERSTAR - 2002 &gt; -



RIF. OCAP OCAP REF.	RIF. ORIG O.E. NUMBER	NOTE REMARKS	MODELLO / DESCRIZIONE MODEL / DESCRIPTION
0281495 	7701470364 48520-00QAJ 4501263 9161563	L=222  M=16x1,5 RHT	TESTA STERZO TIE ROD END
0291495 	7701470363 48520-00QAH 4501262 9161562	L=222  M=16x1,5 RHT	TESTA STERZO TIE ROD END
0603811 	- 48521-00QAF	M=16x1,5 RHT	SNODO ASSIALE STERZO AXIAL JOINT
0401494 	7700312852 40160-00QAD 4500255 9160555		SNODO SOSPENSIONE - INFERIORE BALL JOINT - LOWER
0381494 	7700309190 54500-00QAC 4404048 54500-00QAD 4500093 54500-00QAE 9160393 4418213		BRACCIO OSCILLANTE - ASSE ANTERIORE INFERIORE TRACK CONTROL ARM - FRONT AXLE LOWER
0391494 	7700309189 54501-00QAC 4500092 54501-00QAD 9160392 54501-00QAE 4418212		BRACCIO OSCILLANTE - ASSE ANTERIORE INFERIORE TRACK CONTROL ARM - FRONT AXLE LOWER
0401522 	7700312851 40160-00QAB	M=14x1,5 RHT	SNODO SOSPENSIONE BRACCIO SUPERIORE LATO ESTERNO BALL JOINT UPPER CONTROL ARM OUTER SIDE

**NISSAN: INTERSTAR - 2002 > -**

RIF. OCAP OCAP REF.	RIF. ORIG O.E. NUMBER	NOTE REMARKS	MODELLO / DESCRIZIONE MODEL / DESCRIPTION
<b>1215609</b>  	<b>7700302122</b> 54570-00QAA 4500094 9160394		SILENBLOC CENTRALE CENTRAL BUSHING
<b>1215610</b>  	<b>7700302123</b> 54423-00QAA 4500095 9160395		SILENBLOC ESTREMO OUTER BUSHING
<b>0583812</b>  	<b>54618-00QAA</b> 7700309071 7700307343 4500199 9160499		STABILIZZATORE - ASSE ANTERIOREE STABILIZER LINK - FRONT AXLE
<b>0593812</b>  	<b>54618-00QAB</b> 7700309070 7700302165 4500198 9160498		STABILIZZATORE - ASSE ANTERIOREE STABILIZER LINK - FRONT AXLE







## OPEL: MOVANO - 1999 &gt; -

RIF. OCAP OCAP REF.	RIF. ORIG O.E. NUMBER	NOTE REMARKS	MODELLO / DESCRIZIONE MODEL / DESCRIPTION
<b>0281495</b> 	<b>7701470364</b> 48520-00QAJ 4501263 9161563	L=222  M=16x1,5 RHT	TESTA STERZO TIE ROD END
<b>0291495</b> 	<b>7701470363</b> 48520-00QAH 4501262 9161562	L=222  M=16x1,5 RHT	TESTA STERZO TIE ROD END
<b>0603811-K</b> 	<b>4501261</b> 9161561		KIT SNODO ASSIALE AXIAL JOINT KIT
<b>0603811</b> 	- 48521-00QAF	M=16x1,5 RHT	SNODO ASSIALE AXIAL JOINT
<b>0401494</b> 	<b>7700312852</b> 40160-00QAD 4500255 9160555		SNODO SOSPENSIONE BALL JOINT
<b>0381494</b> 	<b>7700309190</b> 54500-00QAC 4404048 54500-00QAD 4500093 54500-00QAE 9160393 4418213		BRACCIO OSCILLANTE TRACK CONTROL ARM
<b>0391494</b> 	<b>7700309189</b> 54501-00QAC 4500092 54501-00QAD 9160392 54501-00QAE 4418212		BRACCIO OSCILLANTE TRACK CONTROL ARM





**OPEL: MOVANO - 1999 > -**

RIF. OCAP OCAP REF.	RIF. ORIG O.E. NUMBER	NOTE REMARKS	MODELLO / DESCRIZIONE MODEL / DESCRIPTION
<b>1215609</b>  	<b>7700302122</b> 54570-00QAA 4500094 9160394		SILENBLOC CENTRALE CENTRAL BUSHING
<b>1215610</b>  	<b>7700302123</b> 54423-00QAA 4500095 9160395		SILENBLOC ESTREMO OUTER BUSHING
<b>0401522</b>  	<b>7700312851</b> 40160-00QAB	M=14x1,5 RHT	SNODO SOSPENSIONE BRACCIO SUPERIORE LATO ESTERNO BALL JOINT UPPER CONTROL ARM OUTER SIDE
<b>0401523</b>  	<b>4401910</b> 4500090		SNODO SOSPENSIONE BRACCIO SUPERIORE LATO INTERNO BALL JOINT UPPER CONTROL ARM INNER SIDE
<b>0583812</b>  	<b>54618-00QAA</b> 7700309071 7700307343 4500199 9160499		STABILIZZATORE - ASSE ANTERIORE STABILIZER LINK - FRONT AXLE
<b>0593812</b>  	<b>54618-00QAB</b> 7700309070 7700302165 4500198 9160498		STABILIZZATORE - ASSE ANTERIORE STABILIZER LINK - FRONT AXLE





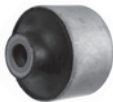



## OPEL: MOVANO B - 05/2010 &gt; -

RIF. OCAP OCAP REF.	RIF. ORIG O.E. NUMBER	NOTE REMARKS	MODELLO / DESCRIZIONE MODEL / DESCRIPTION
<b>0281536</b> 	<b>4420098</b> 93167689 485200780R	M=18x1,5 RHT	TESTA STERZO TIE ROD END
<b>0291536</b> 	<b>4420097</b> 93167688 485206730R	M=18x1,5 RHT	TESTA STERZO TIE ROD END
<b>0901536</b> 	<b>4420096</b> 93167687 485212373R	M=18x1,5 RHT	KIT SNODO ASSIALE AXIAL JOINT KIT
<b>0601536</b> 	<b>4420096 Z</b> 93167687 Z 485212373R	M=18x1,5 RHT	SNODO ASSIALE AXIAL JOINT
<b>0903811</b> 	<b>4501260</b> 9161560 6000025546 Z 6025370231 Z		KIT CUFFIA STERZO STEERING BOOT KIT
<b>1211392</b> 	<b>4501260 Z</b> 9161560 Z 6001547607 7701470361 6025370231		CUFFIA STERZO STEERING BOOT
<b>0401536</b> 	<b>4419219</b> 93197233 8200688877 401608374R	M=16x1,5 RHT	SNODO SOSPENSIONE - ASSE ANTERIORE - INFERIORE BALL JOINT - FRONT AXLE - LOWER
<b>0381536</b> 	<b>4419216</b> 93197215 8200688875		BRACCIO OSCILLANTE - ASSE ANTERIORE - INFERIORE TRACK CONTROL ARM - FRONT AXLE -LOWER

**OPEL: MOVANO B - 05/2010 > -**

RIF. OCAP OCAP REF.	RIF. ORIG O.E. NUMBER	NOTE REMARKS	MODELLO / DESCRIZIONE MODEL / DESCRIPTION
<b>0391536</b> 	<b>4419215</b> 93197214 8200688871		BRACCIO OSCILLANTE - ASSE ANTERIORE - INFERIORE TRACK CONTROL ARM - FRONT AXLE -LOWER
<b>1216016</b> 	<b>4419217 Z</b> 93197216 Z 8200688832 Z		SILENTBLOC CENTRALE CENTRAL BUSHING
<b>1216017</b> 	<b>4419218 Z</b> 93197232 Z 545601173R		SILENTBLOC ESTREMO OUTER BUSHING
<b>0501536</b> 	<b>4419291</b> 93197325 546180004R	M=10x1,5 RHT	STABILIZZATORE - ASSE ANTERIORE STABILIZER LINK - FRONT AXLE
<b>0501496</b> 	<b>4419304</b> 93197332 551100019R		STABILIZZATORE - ASSE POSTERIORE STABILIZER LINK - REAR AXLE

## OPEL: VIVARO - 2001 &gt; 2014 -



RIF. OCAP OCAP REF.	RIF. ORIG O.E. NUMBER	NOTE REMARKS	MODELLO / DESCRIZIONE MODEL / DESCRIPTION
0283875 	7701049283 4408511	L=209  M=14x1,5 RHT	TESTA STERZO TIE ROD END
0293875 	7701049282	L=209  M=14x1,5 RHT	TESTA STERZO TIE ROD END
0604424-K 	7701473333 4408474		KIT SNODO ASSIALE AXIAL JOINT KIT
0604424 	4408474 *	L=2631,5 RHT  M=14x1,5 RHT	SNODO ASSIALE AXIAL JOINT
0903807 	4408476 7701473334 91160038		KIT CUFFIA STERZO STEERING BOOT KIT
1211589 	4408476 * 7701473334 *		CUFFIA STERZO STEERING BOOT
0403808 	-		SNODO SOSPENSIONE - CON KIT SUSPENSION JOINT - WITH KIT
0783808 	8200247900 4408959 91166461		BRACCIO OSCILLANTE IN LAMIERA - ASSE ANTERIORE PRESSED STEEL ARM - FRONT AXLE >10/2006

**OPEL: VIVARO - 2001 > 2014 -**









RIF. OCAP OCAP REF.	RIF. ORIG O.E. NUMBER	NOTE REMARKS	MODELLO / DESCRIZIONE MODEL / DESCRIPTION
<b>0793808</b> 	<b>8200247898</b> 4408958 91166462		BRACCIO OSCILLANTE IN LAMIERA - ASSE ANTERIORE PRESSED STEEL ARM - FRONT AXLE >10/2006
<b>1215640</b> 	<b>8200002868</b>		SILENTBLOC CENTRALE CENTRAL BUSHING
<b>1215641</b> 	<b>8200002869</b>		SILENTBLOC ESTREMO OUTER BUSHING
<b>0404627</b> 	<b>7701477385</b> 4431869 93161884		SNODO SOSPENSIONE - CON KIT BALL JOINT - WITH KIT - 11/2006 >
<b>0384627</b> 	<b>8200876657</b> 8200626961 8200395034 4418226 4417178 4421646 93862135 93853465		BRACCIO OSCILLANTE - ASSE ANTERIORE TRACK CONTROL ARM - FRONT AXLE 11/2006 >
<b>0394627</b> 	<b>8200876659</b> 8200626959 8200395007 4418225 4417177 4421647 9386136		BRACCIO OSCILLANTE - ASSE ANTERIORE TRACK CONTROL ARM - FRONT AXLE 11/2006 >
<b>1215640</b> 	<b>8200002868</b>		SILENTBLOC CENTRALE CENTRAL BUSHING







## OPEL: VIVARO - 2001 &gt; 2014 -

RIF. OCAP OCAP REF.	RIF. ORIG O.E. NUMBER	NOTE REMARKS	MODELLO / DESCRIZIONE MODEL / DESCRIPTION
<b>1215641</b> 	<b>8200002869</b>		SILENTBLOC ESTREMO OUTER BUSHING
<b>0503878</b> 	<b>8200002870</b> 4408904		STABILIZZATORE - ASSE ANTERIORE STABILIZER LINK - FRONT AXLE







**OPEL: VIVARO - 06/2014 > -**

RIF. OCAP OCAP REF.	RIF. ORIG O.E. NUMBER	NOTE REMARKS	MODELLO / DESCRIZIONE MODEL / DESCRIPTION
<b>0283875</b> 	<b>7701049283</b> 4408511	L=209  M=14x1,5 RHT	TESTA STERZO TIE ROD END
<b>0293875</b> 	<b>7701049282</b>	L=209  M=14x1,5 RHT	TESTA STERZO TIE ROD END
<b>0604424-K</b> 	<b>7701473333</b> 4408474		KIT SNODO ASSIALE AXIAL JOINT KIT
<b>0604424</b> 	<b>4408474 *</b>	L=2631,5 RHT  M=14x1,5 RHT	SNODO ASSIALE AXIAL JOINT
<b>0903807</b> 	<b>4408476</b> 7701473334 91160038		KIT CUFFIA STERZO STEERING BOOT KIT
<b>1211589</b> 	<b>4408476 *</b> 7701473334 *		CUFFIA STERZO STEERING BOOT
<b>0403875</b> 	<b>4422270 *</b> 545006069R *		SNODO SOSPENSIONE - CON KIT SUSPENSION JOINT - WITH KIT
<b>0383875</b> 	<b>4422270</b> 545006069R		BRACCIO OSCILLANTE - ASSE ANTERIORE TRACK CONTROL ARM - FRONT AXLE



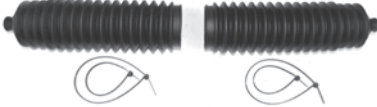



## OPEL: VIVARO - 06/2014 &gt; -

RIF. OCAP OCAP REF.	RIF. ORIG O.E. NUMBER	NOTE REMARKS	MODELLO / DESCRIZIONE MODEL / DESCRIPTION
<b>0393875</b> 	<b>4422269</b> 545019956R		BRACCIO OSCILLANTE - ASSE ANTERIORE TRACK CONTROL ARM - FRONT AXLE
<b>1215640</b> 	<b>8200002868</b>		SILENBLOC CENTRALE CENTRAL BUSHING
<b>1215641</b> 	<b>8200002869</b>		SILENBLOC ESTREMO OUTER BUSHING
<b>0503878</b> 	<b>8200002870</b> 4408904		STABILIZZATORE - ASSE ANTERIORE STABILIZER LINK - FRONT AXLE



**PEUGEOT: BOXER - 1994 > 2006 -**

RIF. OCAP OCAP REF.	RIF. ORIG O.E. NUMBER	NOTE REMARKS	MODELLO / DESCRIZIONE MODEL / DESCRIPTION
<b>0281143</b> 	<b>1306716080</b> 1471655080 4018A3 4018H4	M=16x1,5 RHT	TESTA STERZO - TIE ROD END > 12/2002
<b>0282323</b> 	<b>77362278</b> 4018E0	M=16x1,5 RHT	TESTA STERZO - TIE ROD END > 01/2003 >
<b>0601139</b> 	<b>1471654080</b> 400624 4018A4 9945836	M=16x1,5 RHT	SNODO ASSIALE AXIAL JOINT
<b>0900489</b> 	<b>9946982</b> 400622 401815		KIT CUFFIA STERZO - STERZO MANUALE KIT STEERING BOOT - MANUAL STEERING
<b>1211310</b> 	<b>9946982</b> 4018A5		CUFFIA STERZO - SERVOSTERZO STEERING BOOT - POWER STEERING
<b>0900449</b> 	<b>9945837</b> 406635		KIT CUFFIE STERZO - SERVOSTERZO KIT STEERING BOOTS - POWER STEERING
<b>0401137</b> 	<b>1302368080</b> 3640.32 364032		SNODO SOSPENSIONE - BALL JOINT MOD. 1.0 - 1.4 t. > 01/2001
<b>0381141</b> 	<b>1308601080</b> 1317241080 1320787080 352165 3521.65		BRACCIO OSCILLANTE - TRACK CONTROL ARM MOD. 1.0 - 1.4 t. - > 01/2001

## PEUGEOT: BOXER - 1994 &gt; 2006 -

RIF. OCAP OCAP REF.	RIF. ORIG O.E. NUMBER	NOTE REMARKS	MODELLO / DESCRIZIONE MODEL / DESCRIPTION
0391141 	1308600080 1317240080 1320786080 352095 3520.95		BRACCIO OSCILLANTE - TRACK CONTROL ARM MOD. 1.0 - 1.4 t. - > 01/2001
0401446 	1331640080 364055 3640.55		SNODO SOSPENSIONE - BALL JOINT MOD. 1.0 - 1.4 t. - 02/2001 >
0381446 	1339467080 1331940080 3521J3 3521.J3		BRACCIO OSCILLANTE - TRACK CONTROL ARM MOD. 1.0 - 1.4 t. - 02/2001 >
0391446 	1339465080 1331938080 3520N3 3520.N3		BRACCIO OSCILLANTE - TRACK CONTROL ARM MOD. 1.0 - 1.4 t. - 02/2001 >
0401138 	1300473080 364033 3640.33		SNODO SOSPENSIONE - BALL JOINT MOD. 1.8 t - > 01/2001
0381140 	1308760080 1317239080 1320756080 352166 3521.66		BRACCIO OSCILLANTE - TRACK CONTROL ARM MOD. 1.8 t - > 01/2001

**PEUGEOT: BOXER - 1994 > 2006 -**







RIF. OCAP OCAP REF.	RIF. ORIG O.E. NUMBER	NOTE REMARKS	MODELLO / DESCRIZIONE MODEL / DESCRIPTION
<b>0391140</b> 	<b>1320755080</b> 1317238080 1308759080 352096 3520.96		BRACCIO OSCILLANTE - TRACK CONTROL ARM MOD. 1.8 t - > 01/2001
<b>0401451</b> 	<b>1331641080</b> 364054 3640.54		SNODO SOSPENSIONE - BALL JOINT MOD. 1.8 t - 02/2001 >
<b>0381451</b> 	<b>1339466080</b> 1331939080 3521J4 3521.J4		BRACCIO OSCILLANTE - TRACK CONTROL ARM MOD. 1.8 t - 02/2001 >
<b>0391451</b> 	<b>1339464080</b> 1331937080 3520N4 3520.N4		BRACCIO OSCILLANTE - TRACK CONTROL ARM MOD. 1.8 t - 02/2001 >
<b>1215176</b> 	-		SILENBLOC CENTRALE CENTRAL BUSHING
<b>1215177</b> 	-		SILENBLOC ESTREMO OUTER BUSHING
<b>0181602</b> 	<b>1300716080</b>		PUNTONE BARRA STABILIZZATRICE STABILIZER LINK



## PEUGEOT: BOXER - 1994 &gt; 2006 -

RIF. OCAP OCAP REF.	RIF. ORIG O.E. NUMBER	NOTE REMARKS	MODELLO / DESCRIZIONE MODEL / DESCRIPTION
<b>0181602-K</b> 	1300716080 (1) 15503811 (2) 1300721080 (3) 1300720080 (4)		KIT PUNTONE BARRA STABILIZZATRICE STABILIZER LINK KIT









**PEUGEOT: BOXER - 2006 > -**

RIF. OCAP OCAP REF.	RIF. ORIG O.E. NUMBER	NOTE REMARKS	MODELLO / DESCRIZIONE MODEL / DESCRIPTION
<b>0282637</b> 	<b>381770</b> 77364009	M=16x1,5 RHT	TESTA STERZO TIE ROD END
<b>0292637</b> 	<b>381777</b> 77364253	M=16x1,5 RHT	TESTA STERZO TIE ROD END
<b>0602637</b> 	<b>4000SF *</b> 4000SG * 1341019080 * 1345854080 *	M=16x1,5 RHT	SNODO ASSIALE AXIAL JOINT
<b>0902637</b> 	<b>406686</b> 77364254		KIT CUFFIA STERZO STEERING BOOT KIT
<b>0402638</b> 	<b>364067</b> 50705629		SNODO SOSPENSIONE - ASSE ANTERIORE BALL JOINT - FRONT AXLE MOD. Q11-Q15-Q17L-Q17Q-Q20
<b>0382638</b> 	<b>3521P1</b> 1352225080		BRACCIO OSCILLANTE - ASSE ANTERIORE - INFERIORE TRACK CONTROL ARM FRONT AXLE - LOWER MOD. Q11-Q15-Q17L
<b>0392638</b> 	<b>3520S0</b> 1352227080		BRACCIO OSCILLANTE - ASSE ANTERIORE - INFERIORE TRACK CONTROL ARM FRONT AXLE - LOWER MOD. Q11-Q15-Q17L

## PEUGEOT: BOXER - 2006 &gt; -

RIF. OCAP OCAP REF.	RIF. ORIG O.E. NUMBER	NOTE REMARKS	MODELLO / DESCRIZIONE MODEL / DESCRIPTION
0382639 	3521P2 1352226080		BRACCIO OSCILLANTE - ASSE ANTERIORE - INFERIORE TRACK CONTROL ARM FRONT AXLE - LOWER MOD. Q17H-Q20
0392639 	3520S1 1352228080		BRACCIO OSCILLANTE - ASSE ANTERIORE - INFERIORE TRACK CONTROL ARM FRONT AXLE - LOWER MOD. Q17H-Q20
1215822 	-		SILENTBLOC CENTRALE - CENTRAL BUSHING
1215823 	-		SILENTBLOC ESTREMO - OUTER BUSHING
0182638 	1350658080 Z 1357572080 Z 5081N9 Z		STABILIZZATORE - ASSE ANTERIORE - STABILIZER LINK - FRONT AXLE
0503520 	1355449080 Z		STABILIZZATORE - ASSE POSTERIORE - STABILIZER LINK - REAR AXLE









**PEUGEOT: EXPERT - 1995 > 2006 -**

RIF. OCAP OCAP REF.	RIF. ORIG O.E. NUMBER	NOTE REMARKS	MODELLO / DESCRIZIONE MODEL / DESCRIPTION
<b>0280037</b> 	<b>405909</b> 9404059080 1306003080 4322906 3265974	M=14x1,5 RHT	TESTA STERZO - TIE ROD END
<b>0600918</b> 	<b>3812A4</b> 9566950880	M=14x1,5 RHT	SNODO ASSIALE - AXIAL JOINT
<b>0381184</b> 	<b>71737048</b> 1313084080 1333755080 1322664080 1317390080 1316736080		BRACCIO OSCILLANTE - TRACK CONTROL ARM
<b>0391184</b> 	<b>71737047</b> 1313083080 1333754080 1322663080 1317389080 1316735080		BRACCIO OSCILLANTE - TRACK CONTROL ARM
<b>1215173</b> 	-		SILENTBLOCK CENTRALE - CENTRAL BUSHING
<b>1215174</b> 	-		SILENTBLOCK ESTREMO - DX OUTER BUSHING - RH
<b>1215175</b> 	-		SILENTBLOCK ESTREMO - SX OUTER BUSHING - LH
<b>0181322-K</b> 	<b>1308664080 *</b> 15503811 * 1311025080 * 1313056080 * 508735 *		KIT PUNTONE BARRA STABILIZZATRICE STABILIZER LINK KIT

## PEUGEOT: EXPERT - 1995 &gt; 2006 -

RIF. OCAP OCAP REF.	RIF. ORIG O.E. NUMBER	NOTE REMARKS	MODELLO / DESCRIZIONE MODEL / DESCRIPTION
<b>0181322</b> 	<b>508735</b>		PUNTONE BARRA STABILIZZATRICE STABILIZER LINK

**PEUGEOT: EXPERT - 2007 > -**



RIF. OCAP OCAP REF.	RIF. ORIG O.E. NUMBER	NOTE REMARKS	MODELLO / DESCRIZIONE MODEL / DESCRIPTION
<b>0282733</b> 	<b>381773</b> 9403817738	M=14x1,5 RHT	TESTA STERZO - TIE ROD END
<b>0602733</b> 	<b>3812F0</b> 1497552080 1401381380	M=14x1,5 RHT	SNODO ASSIALE STERZO AXIAL JOINT
<b>1211477</b> 	<b>406683 *</b> 9404066838 *		CUFFIA STERZO STEERING GAITER
<b>0902733</b> 	<b>406683</b> 9404066838		KIT CUFFIA STERZO STEERING GAITER KIT
<b>0382734</b> 	<b>3521N9</b> 1497407080		BRACCIO OSCILLANTE TRACK CONTROL ARM
<b>0392734</b> 	<b>3520R8</b> 1497408080		BRACCIO OSCILLANTE TRACK CONTROL ARM
<b>1215646</b> 			SILENTBLOCK ESTREMO - DX OUTER BUSHING - RH
<b>1215647</b> 			SILENTBLOCK ESTREMO - SX OUTER BUSHING - LH



## PEUGEOT: EXPERT - 2007 &gt; -

RIF. OCAP OCAP REF.	RIF. ORIG O.E. NUMBER	NOTE REMARKS	MODELLO / DESCRIZIONE MODEL / DESCRIPTION
<b>1215870</b> 			SILENTBLOCK CENTRALE CENTRAL BUSHING
<b>0502735</b> 	<b>508756</b> 1400099680		STABILIZZATORE - ASSE ANTERIORE STABILIZER LINK - FRONT AXLE



**RENAULT: MASTER - 1981 > 1998 -**

RIF. OCAP OCAP REF.	RIF. ORIG O.E. NUMBER	NOTE REMARKS	MODELLO / DESCRIZIONE MODEL / DESCRIPTION
<b>0282240</b> 	<b>7701462427</b>	L=100  M=16x1,5 RHT	TESTA STERZO TIE ROD END
<b>0402241</b> 	<b>7701462692</b>	M=16x1,5 RHT	SNODO SOSPENSIONE SUPERIORE BALL JOINT UPPER
<b>0402242</b> 	<b>7701462693</b>	M=16x1,5 RHT	SNODO SOSPENSIONE INFERIORE BALL JOINT LOWER







## RENAULT: MASTER - 1998 &gt; -

RIF. OCAP OCAP REF.	RIF. ORIG O.E. NUMBER	NOTE REMARKS	MODELLO / DESCRIZIONE MODEL / DESCRIPTION
<b>0281495</b> 	<b>7701470364</b> 48520-00QAJ 4501263 9161563	L=222  M=16x1,5 RHT	TESTA STERZO TIE ROD END
<b>0291495</b> 	<b>7701470363</b> 48520-00QAH 4501262 9161562	L=222  M=16x1,5 RHT	TESTA STERZO TIE ROD END
<b>0603811</b> 	- 48521-00QAF	M=16x1,5 RHT	SNODO ASSIALE STERZO AXIAL JOINT
<b>0601496-K</b> 	<b>7701470362</b>		SNODO ASSIALE CON KIT AXIAL JOINT KIT
<b>1211392</b> 	<b>4501260 Z</b> 9161560 Z 6001547607 7701470361 6025370231		CUFFIA STERZO STEERING BOOT
<b>0401494</b> 	<b>7700312852</b> 40160-00QAD 4500255 9160555		SNODO SOSPENSIONE SUSPENSION JOINT
<b>0381494</b> 	<b>7700309190</b> 54500-00QAC 4404048 54500-00QAD 4500093 54500-00QAE 9160393 4418213		BRACCIO OSCILLANTE TRACK CONTROL ARM



**RENAULT: MASTER - 1998 > -**

RIF. OCAP OCAP REF.	RIF. ORIG O.E. NUMBER	NOTE REMARKS	MODELLO / DESCRIZIONE MODEL / DESCRIPTION
<b>0391494</b> 	<b>7700309189</b> 54501-00QAC 4500092 54501-00QAD 9160392 54501-00QAE 4418212		BRACCIO OSCILLANTE TRACK CONTROL ARM
<b>1215609</b> 	<b>7700302122</b> 54570-00QAA 4500094 9160394		SILENTBLOC CENTRALE CENTRAL BUSHING
<b>1215610</b> 	<b>7700302123</b> 54423-00QAA 4500095 9160395		SILENTBLOC ESTREMO OUTER BUSHING
<b>0401522</b> 	<b>7700312851</b> 40160-00QAB	M=14x1,5 RHT	SNODO SOSPENSIONE BRACCIO SUPERIORE LATO ESTERNO BALL JOINT UPPER CONTROL ARM OUTER SIDE
<b>0401523</b> 	<b>4401910</b> 4500090		SNODO SOSPENSIONE BRACCIO SUPERIORE LATO INTERNO BALL JOINT UPPER CONTROL ARM INNER SIDE
<b>0583812</b> 	<b>54618-00QAA</b> 7700309071 7700307343 4500199 9160499		STABILIZZATORE - ASSE ANTERIORE STABILIZER LINK - FRONT AXLE
<b>0593812</b> 	<b>54618-00QAB</b> 7700309070 7700302165 4500198 9160498		STABILIZZATORE - ASSE ANTERIORE STABILIZER LINK - FRONT AXLE

## RENAULT: MASTER III - 02/2010 &gt; -



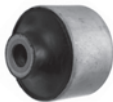

RIF. OCAP OCAP REF.	RIF. ORIG O.E. NUMBER	NOTE REMARKS	MODELLO / DESCRIZIONE MODEL / DESCRIPTION
<b>0281536</b> 	<b>4420098</b> 93167689 485200780R	M=18x1,5 RHT	TESTA STERZO TIE ROD END
<b>0291536</b> 	<b>4420097</b> 93167688 485206730R	M=18x1,5 RHT	TESTA STERZO TIE ROD END
<b>0901536</b> 	<b>4420096</b> 93167687 485212373R	M=18x1,5 RHT	KIT SNODO ASSIALE AXIAL JOINT KIT
<b>0601536</b> 	<b>4420096 Z</b> 93167687 Z 485212373R	M=18x1,5 RHT	SNODO ASSIALE AXIAL JOINT
<b>0903811</b> 	<b>4501260</b> 9161560 6000025546 Z 6025370231 Z		KIT CUFFIA STERZO STEERING BOOT KIT
<b>1211392</b> 	<b>4501260 Z</b> 9161560 Z 6001547607 7701470361 6025370231		CUFFIA STERZO STEERING BOOT
<b>0401536</b> 	<b>4419219</b> 93197233 8200688877 401608374R	M=16x1,5 RHT	SNODO SOSPENSIONE - ASSE ANTERIORE - INFERIORE BALL JOINT - FRONT AXLE - LOWER
<b>0381536</b> 	<b>4419216</b> 93197215 8200688875		BRACCIO OSCILLANTE - ASSE ANTERIORE - INFERIORE TRACK CONTROL ARM - FRONT AXLE -LOWER

**RENAULT: MASTER III - 02/2010 > -**

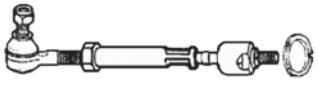

RIF. OCAP OCAP REF.	RIF. ORIG O.E. NUMBER	NOTE REMARKS	MODELLO / DESCRIZIONE MODEL / DESCRIPTION
<b>0391536</b> 	<b>4419215</b> 93197214 8200688871		BRACCIO OSCILLANTE - ASSE ANTERIORE - INFERIORE TRACK CONTROL ARM - FRONT AXLE -LOWER
<b>1216016</b> 	<b>4419217 Z</b> 93197216 Z 8200688832 Z		SILENTBLOC CENTRALE CENTRAL BUSHING
<b>1216017</b> 	<b>4419218 Z</b> 93197232 Z 545601173R		SILENTBLOC ESTREMO OUTER BUSHING
<b>0501536</b> 	<b>4419291</b> 93197325 546180004R	M=10x1,5 RHT	STABILIZZATORE - ASSE ANTERIORE STABILIZER LINK - FRONT AXLE
<b>0501496</b> 	<b>4419304</b> 93197332 551100019R		STABILIZZATORE - ASSE POSTERIORE STABILIZER LINK - REAR AXLE

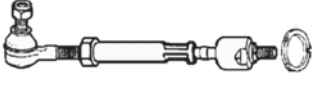

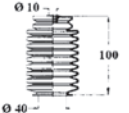
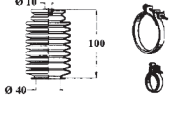
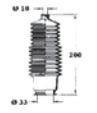



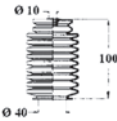
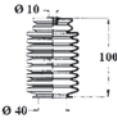

## RENAULT: TRAFIC I - 1980 &gt; 1998 -

RIF. OCAP OCAP REF.	RIF. ORIG O.E. NUMBER	NOTE REMARKS	MODELLO / DESCRIZIONE MODEL / DESCRIPTION
0502230 	7701463035		BARRA STERZO CON KIT - > 09/1981 TIE ROD WITH KIT ASSEMBLY - > 09/1981
0180947 	7701461770	M=14x1,5 RHT	TESTA STERZO TIE ROD END
0602230 	-	M=14x1,5 RHT	SNODO ASSIALE - CON KIT KIT AXIAL JOINT
0502231 	7701462987		BARRA STERZO CON KIT - 10/1981 TIE ROD WITH KIT ASSEMBLY - 10/1981
0180947 	7701461770	M=14x1,5 RHT	TESTA STERZO - RHT M14x1.5 TUTTI I MODELLI TIE ROD END - FOR ALL MODELS
0602231 	-	M=14x1,5 RHT	SNODO ASSIALE - CON KIT KIT AXIAL JOINT
1211267 	7700774566		CUFFIA STERZO - STERZO MANUALE > 1989 SINGLE STEERING BOOT - MANUAL STEERING- > 1989
0902231 	-		KIT CUFFIE STERZO - STERZO MANUALE > 1989 KIT STEERING BOOTS - MANUAL STEERING
1211128 	7700680852		CUFFIA STERZO - STERZO MANUALE - 1989 > SINGLE STEERING BOOT - MANUAL STEERING -1989 >

**RENAULT: TRAFIC I - 1980 > 1998 -**

RIF. OCAP OCAP REF.	RIF. ORIG O.E. NUMBER	NOTE REMARKS	MODELLO / DESCRIZIONE MODEL / DESCRIPTION
<b>1211267</b>  	<b>7700774566</b>		CUFFIA STERZO - STERZO MANUALE > 1989 SINGLE STEERING BOOT - MANUAL STEERING- > 1989
<b>0902230</b>  	-		KIT CUFFIE STERZO - STERZO MANUALE 1989 > KIT STEERING BOOTS - MANUAL STEERING -1989 >
<b>1211123</b>  	<b>7700706007</b>		CUFFIA STERZO - SERVOSTERZO SINGLE STEERING BOOT - POWER STEERING
<b>0402235</b>  	<b>7701461667</b>	M=16x1,5 RHT	SNODO SOSPENSIONE INFERIORE SUSPENSION JOINT LOWER



## RENAULT: TRAFIC II - 03/2001 &gt; -

RIF. OCAP OCAP REF.	RIF. ORIG O.E. NUMBER	NOTE REMARKS	MODELLO / DESCRIZIONE MODEL / DESCRIPTION
0283875 	7701049283 4408511	L=209  M=14x1,5 RHT	TESTA STERZO TIE ROD END
0293875 	7701049282	L=209  M=14x1,5 RHT	TESTA STERZO TIE ROD END
0604424-K 	7701473333 4408474		KIT SNODO ASSIALE AXIAL JOINT KIT
0604424 	4408474 *	L=2631,5 RHT  M=14x1,5 RHT	SNODO ASSIALE AXIAL JOINT
0903807 	4408476 7701473334 91160038		KIT CUFFIA STERZO STEERING BOOT KIT
0403808 	-		SNODO SOSPENSIONE - CON KIT SUSPENSION JOINT - WITH KIT
0783808 	8200247900 4408959 91166461		BRACCIO OSCILLANTE IN LAMIERA - ASSE ANTERIORE PRESSED STEEL ARM - FRONT AXLE >10/2006







**RENAULT: TRAFIC II - 03/2001 > -**

RIF. OCAP OCAP REF.	RIF. ORIG O.E. NUMBER	NOTE REMARKS	MODELLO / DESCRIZIONE MODEL / DESCRIPTION
<b>0793808</b> 	<b>8200247898</b> 4408958 91166462		BRACCIO OSCILLANTE IN LAMIERA - ASSE ANTERIORE PRESSED STEEL ARM - FRONT AXLE >10/2006
<b>1215640</b> 	<b>8200002868</b>		SILENTBLOC CENTRALE CENTRAL BUSHING
<b>1215641</b> 	<b>8200002869</b>		SILENTBLOC ESTREMO OUTER BUSHING
<b>0404627</b> 	<b>7701477385</b> 4431869 93161884		SNODO SOSPENSIONE - CON KIT BALL JOINT - WITH KIT - 11/2006 >
<b>0384627</b> 	<b>8200876657</b> 8200626961 8200395034 4418226 4417178 4421646 93862135 93853465		BRACCIO OSCILLANTE - ASSE ANTERIORE TRACK CONTROL ARM - FRONT AXLE 11/2006 >
<b>0394627</b> 	<b>8200876659</b> 8200626959 8200395007 4418225 4417177 4421647 9386136		BRACCIO OSCILLANTE - ASSE ANTERIORE TRACK CONTROL ARM - FRONT AXLE 11/2006 >
<b>1215641</b> 	<b>8200002869</b>		SILENTBLOC ESTREMO OUTER BUSHING





## RENAULT: TRAFIC II - 03/2001 &gt; -

RIF. OCAP OCAP REF.	RIF. ORIG O.E. NUMBER	NOTE REMARKS	MODELLO / DESCRIZIONE MODEL / DESCRIPTION
<b>1215640</b> 	<b>8200002868</b>		SILENTBLOC CENTRALE CENTRAL BUSHING
<b>0503878</b> 	<b>8200002870</b> 4408904		STABILIZZATORE - ASSE ANTERIORE STABILIZER LINK - FRONT AXLE

**RENAULT: TRAFIC III - 05/2014 > -**

RIF. OCAP OCAP REF.	RIF. ORIG O.E. NUMBER	NOTE REMARKS	MODELLO / DESCRIZIONE MODEL / DESCRIPTION
<b>0283875</b> 	<b>7701049283</b> 4408511	L=209  M=14x1,5 RHT	TESTA STERZO TIE ROD END
<b>0293875</b> 	<b>7701049282</b>	L=209  M=14x1,5 RHT	TESTA STERZO TIE ROD END
<b>0604424-K</b> 	<b>7701473333</b> 4408474		KIT SNODO ASSIALE AXIAL JOINT KIT
<b>0604424</b> 	<b>4408474 *</b>	L=2631,5 RHT  M=14x1,5 RHT	SNODO ASSIALE AXIAL JOINT
<b>0903807</b> 	<b>4408476</b> 7701473334 91160038		KIT CUFFIA STERZO STEERING BOOT KIT
<b>1211589</b> 	<b>4408476 *</b> 7701473334 *		CUFFIA STERZO STEERING BOOT
<b>0403875</b> 	<b>4422270 *</b> 545006069R *		SNODO SOSPENSIONE - CON KIT SUSPENSION JOINT - WITH KIT
<b>0383875</b> 	<b>4422270</b> 545006069R		BRACCIO OSCILLANTE - ASSE ANTERIORE TRACK CONTROL ARM - FRONT AXLE

## RENAULT: TRAFIC III - 05/2014 &gt; -







RIF. OCAP OCAP REF.	RIF. ORIG O.E. NUMBER	NOTE REMARKS	MODELLO / DESCRIZIONE MODEL / DESCRIPTION
<b>0393875</b> 	<b>4422269</b> 545019956R		BRACCIO OSCILLANTE - ASSE ANTERIORE TRACK CONTROL ARM - FRONT AXLE
<b>1215640</b> 	<b>8200002868</b>		SILENBLOC CENTRALE CENTRAL BUSHING
<b>1215641</b> 	<b>8200002869</b>		SILENBLOC ESTREMO OUTER BUSHING
<b>0503878</b> 	<b>8200002870</b> 4408904		STABILIZZATORE - ASSE ANTERIORE STABILIZER LINK - FRONT AXLE









**RENAULT: SG2 - SG4 -**

RIF. OCAP OCAP REF.	RIF. ORIG O.E. NUMBER	NOTE REMARKS	MODELLO / DESCRIZIONE MODEL / DESCRIPTION
<b>0181401</b> 	<b>7701013272</b>	M=16x1,5 RHT	TESTA STERZO TIE ROD END
<b>0191401</b> 	<b>7701013276</b>	M=16x1,5 LHT	TESTA STERZO TIE ROD END
<b>0400951</b> 	<b>5000246731</b>	M=18x1,5 RHT	SNODO SOSPENSIONE - SUPERIORE UPPER BALL JOINT MOD. SG2
<b>0400952</b> 	<b>5000246732</b>	M=20x1,5 RHT	SNODO SOSPENSIONE - INFERIORE LOWER BALL JOINT MOD. SG2
<b>0401398</b> 	<b>5000246729</b>	M=20x1,5 RHT	SNODO SOSPENSIONE - SUPERIORE UPPER BALL JOINT MOD. SG4
<b>0401399</b> 	<b>5000246730</b>	M=24x1,5 RHT	SNODO SOSPENSIONE - INFERIORE LOWER BALL JOINT MOD. SG2

## VOLKSWAGEN: CRAFTER - 2006 &gt; -

RIF. OCAP OCAP REF.	RIF. ORIG O.E. NUMBER	NOTE REMARKS	MODELLO / DESCRIZIONE MODEL / DESCRIPTION
0282717 	9064600048	M=16x1,5 RHT	TESTA STERZO TIE ROD END
0602741-K 	9064600055		KIT SNODO ASSIALE AXIAL JOINT KIT
0602741 	-	M=16x1,5 RHT	SNODO ASSIALE AXIAL JOINT
0902741 	9064600096		KIT CUFFIA STERZO STEERING BOOT KIT
1211481 	-		CUFFIA STERZO STEERING BOOT KIT
0402742 	-		SNODO SOSPENSIONE - ASSE ANTERIORE BALL JOINT - FRONT AXLE
0782742 	2E0407152M		BRACCIO OSCILLANTE - ASSE ANTERIORE TRACK CONTROL ARM - FRONT AXLE

**VOLKSWAGEN: CRAFTER - 2006 > -**

RIF. OCAP OCAP REF.	RIF. ORIG O.E. NUMBER	NOTE REMARKS	MODELLO / DESCRIZIONE MODEL / DESCRIPTION
<b>0792742</b> 	<b>9063304007</b>		BRACCIO OSCILLANTE - ASSE ANTERIORE TRACK CONTROL ARM - FRONT AXLE
<b>1215874</b> 	<b>9063330014</b>		SILENTBLOC - BUSHING
<b>0582743</b> 	<b>9063201889</b>		STABILIZZATORE - ASSE ANTERIORE STABILIZER LINK - FRONT AXLE
<b>0592743</b> 	<b>9063201789</b>		STABILIZZATORE - ASSE ANTERIORE STABILIZER LINK - FRONT AXLE
<b>0502744</b> 	<b>6013201389</b>		STABILIZZATORE - ASSE POSTERIORE STABILIZER LINK - REAR AXLE
<b>1215817</b> 	<b>6013210350</b>		SILENTBLOC STABILIZZATORE - ASSE POSTERIORE STABILIZER LINK BUSHING - REAR AXLE









## VOLKSWAGEN: LT 28-35-46 - 1996 &gt; -

RIF. OCAP OCAP REF.	RIF. ORIG O.E. NUMBER	NOTE REMARKS	MODELLO / DESCRIZIONE MODEL / DESCRIPTION
<b>0501503</b>  <b>0281503</b> M=16x1,5 RHT	<b>9014600205</b> 2D0422803		BARRA STERZO - SCATOLA GUIDA TIE ROD - STEERING BOX
<b>0281503</b> 	<b>9014600348</b> 9014600048 9014600148 2D0422811	L=76  M=16x1,5 RHT	TESTA STERZO - SCATOLA GUIDA TIE ROD END - STEERING BOX
<b>0601504</b> 	<b>9014600155</b> 9014600255 9014600455 2D0422803	M=16x1,5 RHT	SNODO ASSIALE - SCATOLA GUIDA AXIAL JOINT - STEERING BOX
<b>1211400</b> 	<b>2D0422831</b>		CUFFIA STERZO STEERING BOOT
<b>0901504</b> 	<b>9014605500</b> 2D0498831		KIT CUFFIA STERZO STEERING BOOT KIT
<b>0401505</b> 	<b>9013331227</b> 9013331127 9013331027 9013330727 9013330627 2D0407361A	M=20x1,5	SNODO SOSPENSIONE ASSE ANTERIORE BALL JOINT FRONT AXLE
<b>0781505</b> 	<b>9013302507</b> 9013301907 2D0407022B 2D0407022		BRACCIO OSCILLANTE - ANTERIORE TRACK CONTROL ARM - FRONT

**VOLKSWAGEN: LT 28-35-46 - 1996 > -**

RIF. OCAP OCAP REF.	RIF. ORIG O.E. NUMBER	NOTE REMARKS	MODELLO / DESCRIZIONE MODEL / DESCRIPTION
<b>0791505</b> 	<b>9013301807</b> 2D0407021B 2D0407021		BRACCIO OSCILLANTE - ANTERIORE TRACK CONTROL ARM - FRONT
<b>1215705</b> 	<b>9013330214</b> 2D0407140		SILENTBLOC - BUSHING
<b>0581514</b> 	<b>9013200389</b> 2D0411052		STABILIZZATORE - ASSE ANTERIORE CON SILENTBLOC STABILIZER LINK- FRONT AXLE WITH BUSHING
<b>0591514</b> 	<b>9013200289</b> 2D0411051		STABILIZZATORE - ASSE ANTERIORE CON SILENTBLOC STABILIZER LINK - FRONT AXLE WITH BUSHING
<b>0104151</b> 	<b>2D0511329</b> 9013200089	L=95	STABILIZZATORE - ASSE POSTERIORE STABILIZER LINK - REAR AXLE

## VOLKSWAGEN: TRANSPORTER T3 - 1979 &gt; -









RIF. OCAP OCAP REF.	RIF. ORIG O.E. NUMBER	NOTE REMARKS	MODELLO / DESCRIZIONE MODEL / DESCRIPTION
0501501 	251419803 251419803A		BARRA STERZO TIE ROD
0280886 	251419811 171419811		TESTA STERZO TIE RODEND - RHT M14x1,5
0600887 	-		SNODO ASSIALE AXIAL JOINT - RHT M14x1,5
1211142 	251419831A		CUFFIA STERZO - STEERING BOOT
0902079 	-		KIT CUFFIA STERZO - STEERING BOOT KIT
0400888 	251407361		SNODO SOSPENSIONE - ASSE ANTERIORE - SUPERIORE BALL JOINT - FRONT AXLE - UPPER
0400889 	251407187A		SNODO SOSPENSIONE - ASSE ANTERIORE - INFERIORE BALL JOINT - FRONT AXLE - LOWER -PRIMO MONTAGGIO - EARLY - 48.3 mm.
0404001 	251407187C		SNODO SOSPENSIONE - ASSE ANTERIORE - INFERIORE BALL JOINT - FRONT AXLE - LOWER -RICAMBIO - LATE - 48.6 mm.
1214127 	251411041C		SILENTBLOC - BARRA STABILIZZATRICE - ASSE ANTERIORE - STABILIZING BAR BUSHING - FRONT AXLE - DIAM. 20 mm.

**VOLKSWAGEN: TRANSPORTER T3 - 1979 > -**









RIF. OCAP OCAP REF.	RIF. ORIG O.E. NUMBER	NOTE REMARKS	MODELLO / DESCRIZIONE MODEL / DESCRIPTION
<p><b>1215659</b></p> 	<p><b>701407087</b></p>		<p>SILENTBLOC - ASSE POSTERIORE - SUPERIORE - BUSHING - REAR AXLE - UPPER</p>











## VOLKSWAGEN: TRANSPORTER T4 - 1990 &gt; -

RIF. OCAP OCAP REF.	RIF. ORIG O.E. NUMBER	NOTE REMARKS	MODELLO / DESCRIZIONE MODEL / DESCRIPTION
0581405 	701419804C		L H D - BARRA STERZO - TIE ROD > CH. 70-T-199 999
0591405 	701419803C		L H D - BARRA STERZO - TIE ROD > CH. 70-T-199 999
0581406 	702419804A		R H D - BARRA STERZO - TIE ROD > CH. 70-M-096448
0591406 	702419803A		R H D - BARRA STERZO - TIE ROD > CH. 70-M-096448
0281405 	701419812		TESTA STERZO - TIE ROD END > CH. 70-M-096448
0291405 	701419811A		TESTA STERZO - TIE ROD END > CH. 70-M-096448
0581407 	701419804D 702419804B		L H D - BARRA STERZO - TIE ROD CH. 70-M-096 449 > 70-S-002 791
0591407 	701419803D 702419803B		L H D - BARRA STERZO - TIE ROD CH. 70-M-096 449 > 70-S-002 791
0581407 	701419804D 702419804B		R H D - BARRA STERZO - TIE ROD CH. 70-M-096 449 > 70-S-002 791









**VOLKSWAGEN: TRANSPORTER T4 - 1990 > -**

RIF. OCAP OCAP REF.	RIF. ORIG O.E. NUMBER	NOTE REMARKS	MODELLO / DESCRIZIONE MODEL / DESCRIPTION
<b>0591407</b> 	<b>701419803D</b> 702419803B		R H D - BARRA STERZO - TIE ROD CH. 70-M-096 449 > 70-S-002 791
<b>0281407</b> 	<b>701419812A</b>		TESTA STERZO - TIE ROD END CH. 70-M-096 449 > 70-S-002 791
<b>0291407</b> 	<b>701419811B</b>		TESTA STERZO - TIE ROD END CH. 70-M-096 449 > 70-S-002 791
<b>0601412</b> 	-		SNODO ASSIALE - AXIAL JOINT
<b>0601406</b> 	-		SNODO ASSIALE - AXIAL JOINT
<b>0401409</b> 	<b>701407187B</b> 701407187A		SNODO SOSPENSIONE - SUPERIORE - BALL JOINT - UPPER
<b>0401410</b> 	<b>701407361B</b>		SNODO SOSPENSIONE - INFERIORE - BALL JOINT - LOWER
<b>1215660</b> 	<b>701407077A</b>		SILENTBLOC SOSPENSIONE ANTERIORE - SUPERIORE FRONT SUSPENSION BUSHING - UPPER
<b>1215661</b> 	<b>7D0407183</b> 701407183C		SILENTBLOC SOSPENSIONE ANTERIORE - INFERIORE FRONT SUSPENSION BUSHING - LOWER







## VOLKSWAGEN: TRANSPORTER T4 - 1990 &gt; -

RIF. OCAP OCAP REF.	RIF. ORIG O.E. NUMBER	NOTE REMARKS	MODELLO / DESCRIZIONE MODEL / DESCRIPTION
0501443 	7D0411049 701411049		STABILIZZATORE - ASSE ANTERIORE - STABILIZER LINK - FRONT AXLE BARRE - BAR DIAM.23 mm.
0503864 	701411049B		STABILIZZATORE - ASSE ANTERIORE - STABILIZER LINK - FRONT AXLE BARRE - BAR DIAM.27 mm.
1215671 	-		SILENTBLOC STABILIZZATORE - STABILIZER LINK BUSHING
1214105 	701411041		SILENTBLOC BARRA STABILIZZATRICE - STABILIZING BAR BUSHING DIAM. 23 mm.
1214109 	7D0411045		SILENTBLOC BARRA STABILIZZATRICE - STABILIZING BAR BUSHING DIAM. 28,5 mm.
1214270 	701411041D		SILENTBLOC BARRA STABILIZZATRICE - STABILIZING BAR BUSHING DIAM. 27 mm.
1214276 	7D1411041		SILENTBLOC BARRA STABILIZZATRICE - STABILIZING BAR BUSHING DIAM. 23 mm.
1215662 	701501131		SILENTBLOC ASSE POSTERIORE - ESTERNO REAR SUSPENSION BUSHING - OUTER
1215663 	7D0407140A 7D0407140 701407140C 701407140B		SILENTBLOC ASSE POSTERIORE - INFERIORE REAR SUSPENSION BUSHING - LOWER









**VOLKSWAGEN: TRANSPORTER T4 - 1990 > - - CH. 70-S-002 792 >**

RIF. OCAP OCAP REF.	RIF. ORIG O.E. NUMBER	NOTE REMARKS	MODELLO / DESCRIZIONE MODEL / DESCRIPTION
0581411 	701419804E		L H D - BARRA STERZO - TIE ROD > CH. 70-T-199 999
0591411 	701419803E		L H D - BARRA STERZO - TIE ROD > CH. 70-T-199 999
0581412 	702419804C		R H D - BARRA STERZO - TIE ROD > CH. 70-T-199 999
0591412 	702419803C		R H D - BARRA STERZO - TIE ROD > CH. 70-T-199 999
0281411 	701419812B		TESTA STERZO - TIE ROD END > CH. 70-T-199 999
0291411 	701419811C		TESTA STERZO - TIE ROD END > CH. 70-T-199 999
0601412 	-		SNODO ASSIALE - AXIAL JOINT
0601406 	-		SNODO ASSIALE - AXIAL JOINT > CH. 70-T-199 999
0581413 	701419804F		BARRA STERZO - TIE ROD CH. 70-T-200 000 >

## VOLKSWAGEN: TRANSPORTER T4 - 1990 &gt; - - CH. 70-S-002 792 &gt;

RIF. OCAP OCAP REF.	RIF. ORIG O.E. NUMBER	NOTE REMARKS	MODELLO / DESCRIZIONE MODEL / DESCRIPTION
0591413 	702419803D		BARRA STERZO - TIE ROD CH. 70-T-200 000 >
0281413 	701419812D		TESTA STERZO - TIE ROD END CH. 70-T-200 000 >
0291413 	701419811E		TESTA STERZO - TIE ROD END CH. 70-T-200 000 >
0601412 	-		SNODO ASSIALE - AXIAL JOINT
0401409 	701407187B 701407187A		SNODO SOSPENSIONE - SUPERIORE - BALL JOINT - UPPER
0401410 	701407361B		SNODO SOSPENSIONE - INFERIORE - BALL JOINT - LOWER CH. > 70-T-199 999
0401425 	7D0407361		SNODO SOSPENSIONE - INFERIORE - BALL JOINT - LOWER CH. 70-T-200 000 >
1215660 	701407077A		SILENTBLOC SOSPENSIONE ANTERIORE - SUPERIORE FRONT SUSPENSION BUSHING - UPPER
1215661 	7D0407183 701407183C		SILENTBLOC SOSPENSIONE ANTERIORE - INFERIORE FRONT SUSPENSION BUSHING - LOWER

**VOLKSWAGEN: TRANSPORTER T4 - 1990 > - - CH. 70-S-002 792 >**





RIF. OCAP OCAP REF.	RIF. ORIG O.E. NUMBER	NOTE REMARKS	MODELLO / DESCRIZIONE MODEL / DESCRIPTION
0501443 	7D0411049 701411049		STABILIZZATORE - ASSE ANTERIORE - STABILIZER LINK - FRONT AXLE BARRE - BAR DIAM.23 mm.
0503864 	701411049B		STABILIZZATORE - ASSE ANTERIORE - STABILIZER LINK - FRONT AXLE BARRE - BAR DIAM.27 mm.
1215671 	-		SILENTBLOC STABILIZZATORE - STABILIZER LINK BUSHING
1214105 	701411041		SILENTBLOC BARRA STABILIZZATRICE - STABILIZING BAR BUSHING DIAM. 23 mm.
1214109 	7D0411045		SILENTBLOC BARRA STABILIZZATRICE - STABILIZING BAR BUSHING DIAM. 28,5 mm.
1214270 	701411041D		SILENTBLOC BARRA STABILIZZATRICE - STABILIZING BAR BUSHING DIAM. 27 mm.
1214276 	7D1411041		SILENTBLOC BARRA STABILIZZATRICE - STABILIZING BAR BUSHING DIAM. 23 mm.
1215662 	701501131		SILENTBLOC ASSE POSTERIORE - ESTERNO REAR SUSPENSION BUSHING - OUTER
1215663 	7D0407140A 7D0407140 701407140C 701407140B		SILENTBLOC ASSE POSTERIORE - INFERIORE REAR SUSPENSION BUSHING - LOWER

## VOLKSWAGEN: TRANSPORTER T5 - 2003 &gt; -



RIF. OCAP OCAP REF.	RIF. ORIG O.E. NUMBER	NOTE REMARKS	MODELLO / DESCRIZIONE MODEL / DESCRIPTION
0584333 	7H0419804D 7H0419804E		BARRA STERZO - TIE ROD
0594333 	7H0419803D 7H0419803E		BARRA STERZO - TIE ROD
0284333 	7H0422818D 7H0422818C 7H0422818B 7H0422818A		TESTA STERZO - TIE ROD END RHT M16x1,5
0294333 	7H0422817D 7H0422817C 7H0422817B 7H0422817A		TESTA STERZO - TIE ROD END RHT M16x1,5
0604334 	-		SNODO ASSIALE - AXIAL JOINT RHT M16x1,5
1211430 	7H0422831		CUFFIA STERZO - STEERING BOOT
0404336 	7H0407361		SNODO SOSPENSIONE - BALL JOINT MOD: (FURGONATI - VAN) 2,6-3,0 T MOD: (PIANALE PIATTO - CHASSIS CAB) 2,6-2,85 T
0404335 	7H8407361A 7H8407361		SNODO SOSPENSIONE - BALL JOINT MOD: (FURGONATI - VAN) 3,2 T MOD: (PIANALE PIATTO- CHASSIS CAB) 3,0-3,2 T







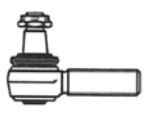
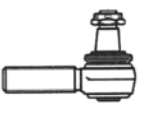
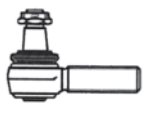
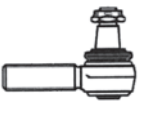

**VOLKSWAGEN: TRANSPORTER T5 - 2003 > -**

RIF. OCAP OCAP REF.	RIF. ORIG O.E. NUMBER	NOTE REMARKS	MODELLO / DESCRIZIONE MODEL / DESCRIPTION
<b>0382723</b> 	<b>7H0407152F</b> 7H0407152G 7H0407152E		BRACCIO OSCILLANTE - ASSE ANTERIORE INFERIORE TRACK CONTROL ARM - FRONT AXLE LOWER
<b>0392723</b> 	<b>7H0407151F</b> 7H0407151G 7H0407151E		BRACCIO OSCILLANTE - ASSE ANTERIORE INFERIORE TRACK CONTROL ARM - FRONT AXLE LOWER
<b>1215873</b> 	<b>7H0407183</b>		SILENTBLOC CENTRALE - CENTRAL BUSHING
<b>1215872</b> 	<b>7H0407182A</b>		SILENTBLOC ESTREMO - OUTER BUSHING
<b>0504337</b> 	<b>7H5411317A</b> 7H5411317		STABILIZZATORE - ASSE ANTERIORE STABILIZER LINK - FRONT AXLE

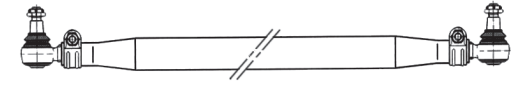

## TESTE STERZO - TIE RODS END

RIF. OCAP OCAP REF.	RIF. ORIG O.E. NUMBER	NOTE REMARKS	MODELLO / DESCRIZIONE MODEL / DESCRIPTION
<b>0186598</b>  	<b>101694</b> 113254	L= 120  M= 30x1,5 RHT	ASTRA BM
<b>0196598</b>  	<b>101695</b> 113253	L= 120  M= 30x1,5 LHT	ASTRA BM
<b>0186421</b>  	<b>10229</b>	L= 125  M= 38x1,5 RHT	ASTRA BM
<b>0196421</b>  	<b>30042</b>	L= 125  M= 38x1,5 LHT	ASTRA BM
<b>0186422</b>  	<b>101347</b> 113251	L= 135  M= 38x1,5 RHT	ASTRA BM 304-305 F
<b>0196422</b>  	<b>101348</b> 113252	L= 135  M= 38x1,5 LHT	ASTRA BM 304-305 F







**BARRE ACCOPPIAMENTO - TIE RODS**

RIF. OCAP OCAP REF.	RIF. ORIG O.E. NUMBER	NOTE REMARKS	MODELLO / DESCRIZIONE MODEL / DESCRIPTION
<p><b>0507942</b></p>  <p><b>0187843</b> M=30x1,5 RHT</p>	<p><b>1297572</b> 1361155</p>	<p>L=1522 T=52</p>	<p>95 XF - CF 75 - CF 85 - XF 105 - XF 95</p>
<p><b>0506167</b></p>  <p><b>0186424</b> M=28x1,5 RHT      <b>0196424</b> M=28x1,5 LHT</p>	<p><b>1408040</b> HJK3892</p>	<p>L=1635</p>	<p>55 LF</p>
<p><b>0506168</b></p>  <p><b>0186168</b> RHT M28x1,5      <b>0196168</b> LHT M28x1,5</p>	<p><b>1407963</b></p>	<p>L=1640</p>	<p>45 LF</p>
<p><b>0507800</b></p>  <p><b>0186598</b> M=30x1,5 RHT</p>	<p><b>1286342</b> 0275962</p>	<p>L=1686</p>	<p>75 CF - 85 CF - F 75 - F 85 - F 95 75 XF - 85 XF - 95 XF</p>
<p><b>0507949</b></p>  <p><b>0186598</b> M=30x1,5 RHT      <b>0196598</b> M=30x1,5 LHT</p>	<p><b>1700000</b></p>	<p>L=1690 T=40</p>	<p>CF 65 - CF 75 - CF 85 - XF 105</p>
<p><b>0506432</b></p>  <p><b>0186424</b> M=30x1,5 RHT</p>	<p><b>1286343</b> 1353396</p>	<p>L=1698 T=52</p>	<p>75 CF - 85 CF - F 65 - F 75 - F 85 - F 95 75 XF - 85 XF - 95 XF CF 75 - CF 85 XF95 - XF 105</p>





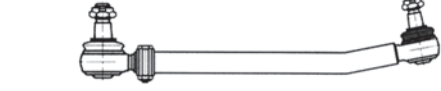

**BARRE ACCOPPIAMENTO - TIE RODS**

RIF. OCAP OCAP REF.	RIF. ORIG O.E. NUMBER	NOTE REMARKS	MODELLO / DESCRIZIONE MODEL / DESCRIPTION
<p><b>0507933</b></p>  <p><b>0186424</b>      <b>0196424</b> M=30x1,5 RHT   M=30x1,5 LHT</p>	<p><b>1270853</b> 1353391</p>	<p>L=1698 T=40</p>	<p>95 XF - CF 65 - CF 75 - CF 85 LF 55 - XF 95 - XF 105</p>
<p><b>0507931</b></p>  <p><b>0187843</b>      <b>0187843</b> M=30x1,5 RHT   M=30x1,5 RHT</p>	<p><b>1361157</b> 1353400 1295415</p>	<p>L=1733 T=52</p>	<p>85 CF - F 2100</p>
<p><b>0507934</b></p>  <p><b>0186424</b>      <b>0196424</b> M=30x1,5 RHT   M=30x1,5 LHT</p>	<p><b>1337644</b> 0288281 288281 1270854</p>	<p>L=1734 T=40</p>	<p>75 CF-FA - 85 CF-FA - 95 XF - CF 75-85 LF 45-55 - XF 95-105</p>







TIRANTI LONGITUDINALI - DRAG LINKS

RIF. OCAP OCAP REF.	RIF. ORIG O.E. NUMBER	NOTE REMARKS	MODELLO / DESCRIZIONE MODEL / DESCRIPTION
<p><b>0507939</b></p>  <p><b>0186424</b> M=30x1,5 RHT</p>	<p><b>1385488</b> 1351730 0593883 1351745</p>	<p>L=622 T=42</p>	<p>75 CF - 85CF - 85 FT</p>
<p><b>0507930</b></p>  <p><b>0187723</b> M=30x1,5 RHT</p>	<p><b>1143319</b> 1144018</p>	<p>L=708 T=42</p>	
<p><b>0507798</b></p>  <p><b>0186598</b> M=30x1,5 RHT</p>	<p><b>0890991</b></p>	<p>L=715</p>	<p>F 1700 - F 1900</p>
<p><b>0507924</b></p>  <p><b>0186598</b> M30x1,5 RHT</p>	<p><b>S009593</b> 0087932 389870</p>	<p>L=716 T=50</p>	
<p><b>0506431</b></p>  <p><b>0186758</b> M=30x1,5 RHT</p>	<p><b>0094016</b> 0171215</p>	<p>L=744</p>	<p>F 95 - F 2100-F 2300-F 2500-F 2700</p>
<p><b>0507944</b></p>  <p><b>0186424</b> M=30x1,5 RHT      <b>0196424</b> M=30x1,5 LHT</p>	<p><b>1385490</b> 1351732 1257992</p>	<p>L=831 T=36</p>	<p>85 FAD</p>

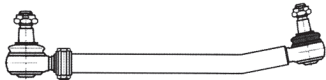
TIRANTI LONGITUDINALI - DRAG LINKS





RIF. OCAP OCAP REF.	RIF. ORIG O.E. NUMBER	NOTE REMARKS	MODELLO / DESCRIZIONE MODEL / DESCRIPTION
<p><b>0506434</b></p>  <p><b>0186424</b> M=30x1,5 RHT</p>	<p><b>1283212</b> 1247957 1385492</p>	<p>L=848 T=52</p>	<p>F 75 - 65 CF - 75 CF - 85 CF - 75 XF CF 75 - CF 85</p>
<p><b>0507935</b></p>  <p><b>0186598</b> M=30x1,5 RHT</p>	<p><b>1363858</b> 1602820 1448062</p>		<p>CF 65 - CF 75 - CF 85</p>
<p><b>0507784</b></p>  <p><b>0186424</b> M=30x1,5 RHT</p>	<p><b>1257991</b> 1351718 1385493</p>	<p>L=860 T=36</p>	<p>75 CF - 85 CF-430 FAD</p>
<p><b>0507937</b></p>  <p><b>0186598</b> M=30x1,5 RHT    <b>0196598</b> M=30x1,5 LHT</p>	<p><b>1451118</b></p>	<p>L=860 T=38</p>	<p>CF 75 - CF 85 - XF 95</p>
<p><b>0507938</b></p>  <p><b>0186598</b> M=30x1,5 RHT</p>	<p><b>1451129</b> 1380417</p>	<p>L=860 T=36</p>	<p>CF 75 - CF 85</p>
<p><b>0507948</b></p>  <p><b>0186598</b> M=30x1,5 RHT</p>	<p><b>1602821</b> 1448063 1363859</p>	<p>L=867 T=50</p>	<p>CF 65 - CF 75 - CF 85</p>

TIRANTI LONGITUDINALI - DRAG LINKS



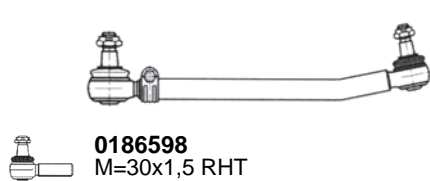

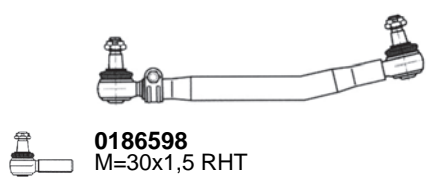
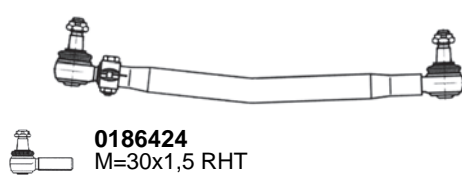
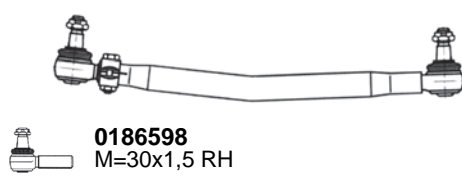
RIF. OCAP OCAP REF.	RIF. ORIG O.E. NUMBER	NOTE REMARKS	MODELLO / DESCRIZIONE MODEL / DESCRIPTION
<p><b>0506429</b></p>  <p><b>0186758</b> M=30x1,5 RHT</p>	<p><b>0094029</b> 0117343</p>	<p>L=872</p>	<p>F 95 - F 2300-F 2800 F 3300-F 3600</p>
<p><b>0506435</b></p>  <p><b>0186424</b> M=30x1,5 RHT</p>	<p><b>1283211</b> 1247956 1385497 1351714</p>	<p>L=876 T=52</p>	<p>CF 75 - CF 85 - F 75- F 85 65 CF - 75 CF - 85 CF 75 XF- 85 XF</p>
<p><b>0507943</b></p>  <p><b>0187943</b> M=30x1,5 RHT</p>	<p><b>1143322</b> 1193034</p>	<p>L=882 T=52</p>	
<p><b>0507928</b></p>  <p><b>0197928</b> M=30x1,5 LHT</p>	<p><b>1405655</b> 1406025 1700912 1407144 1401940</p>	<p>L=900 T=38</p>	<p>LF 45 FA</p>
<p><b>0507947</b></p>  <p><b>0186598</b> M=30x1,5 RHT</p>	<p><b>1395994</b></p>	<p>L=991 T=50</p>	<p>XF 95 - XF 105</p>
<p><b>0506430</b></p>  <p><b>0186598</b> M=30x1,5 RHT</p>	<p><b>0094038</b> 0554765 094038 554765 94038 525443</p>	<p>L=995 T=52</p>	<p>F 85 - F 95- XF 95 - 95 XF</p>









**TIRANTI LONGITUDINALI - DRAG LINKS**

RIF. OCAP OCAP REF.	RIF. ORIG O.E. NUMBER	NOTE REMARKS	MODELLO / DESCRIZIONE MODEL / DESCRIPTION
<p><b>0507492</b></p>  <p><b>0186598</b> M=30x1,5 RHT</p>	<p><b>0094037</b></p>	<p>L=998</p>	<p>85 CF</p>
<p><b>0507932</b></p>  <p><b>0186424</b></p>	<p><b>1385498</b> 1311048 1351737</p>	<p>L=998 T=36</p>	<p>95 XF - XF 95</p>
<p><b>0507495</b></p>  <p><b>0186598</b> M=30x1,5 RHT</p>	<p><b>0098726</b></p>	<p>L=999</p>	
<p><b>0506433</b></p>  <p><b>0186424</b> M=30x1,5 RHT</p>	<p><b>1291060</b> 1385499 1351734</p>	<p>L=1005 T=52</p>	<p>F 95- XF 95 75 CF - 85 CF - 95 XF U.S.</p>
<p><b>0507799</b></p>  <p><b>0186598</b> M=30x1,5 RH</p>	<p><b>0094613</b> 94613 0362413</p>	<p>L=1008</p>	<p>F 95 - 95 XF</p>
<p><b>0507945</b></p>  <p><b>0186598</b> M=30x1,5 RH</p>	<p><b>0094044</b> 0274878 1152427</p>	<p>L=1130 T=40</p>	





TIRANTI LONGITUDINALI - DRAG LINKS

RIF. OCAP OCAP REF.	RIF. ORIG O.E. NUMBER	NOTE REMARKS	MODELLO / DESCRIZIONE MODEL / DESCRIPTION
<p><b>0507946</b></p>  <p><b>0186424</b> M=30x1,5 RH</p>	<p><b>1143324</b> 1191900</p>	<p>L=1197 T=40</p>	
<p><b>0507494</b></p>  <p><b>0186598</b> M=30x1,5 RHT</p>	<p><b>0094053</b></p>	<p>L=1544</p>	
<p><b>0507940</b></p> 	<p><b>1315530</b> 1351731 1385506</p>	<p>L=1658 T=52</p>	
<p><b>0507941</b></p> 	<p><b>1346489</b> 1351720 1385513</p>	<p>L=1818 T=42</p>	
<p><b>0507936</b></p> 	<p><b>1451122</b> 1392640</p>	<p>L=1977 T=52</p>	<p>CF 75 - CF 85</p>



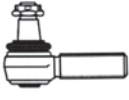

**TESTE STERZO - TIE RODS END**

RIF. OCAP OCAP REF.	RIF. ORIG O.E. NUMBER	NOTE REMARKS	MODELLO / DESCRIZIONE MODEL / DESCRIPTION
<b>0289923</b> 	<b>1271126</b> 42538048 82953016019 81953016268 82953016018 3099128 3090291	L=90 M=36x1,5 RHT	
<b>0287503</b> 	<b>0273203</b> 1399724	L=95  M=22x1,5 RHT	CF75-XF95-XF105
<b>0186595</b> 	<b>0608530</b>	L=95  M=24x1,5 RH	Serie 400 95 - 95 XF
<b>0287291</b> 	<b>0817824</b>	L=95  M=24x1,5 RHT	LF 55
<b>0186613</b> 	<b>0607451</b> 1373135 0607453 0110197 1228114 ACU9242	L=105  M=28x1,5 RHT	XF-F
<b>0196613</b> 	<b>0607452</b> 0110196 1373137 ACU9241	L=105  M=28x1,5 LHT	XF-F
<b>0186608</b> 	<b>1689604</b> 1923963		LF 45 FA
<b>0196608</b> 	<b>1689605</b> 1923962 8123326	L=115  M=28x1,5 RHT	LF 45 FA

**TESTE STERZO - TIE RODS END**

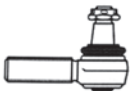
RIF. OCAP OCAP REF.	RIF. ORIG O.E. NUMBER	NOTE REMARKS	MODELLO / DESCRIZIONE MODEL / DESCRIPTION
<b>0186424</b> 	<b>0586753</b> 1320855 1229944 1342026 0607999 0694298 0694360 0698609 586753 698609 1326896 MAK1296	L=115  M=30x1,5 RHT	65/75/85 CF - 95 XF CF 75/85 F 65/75/85/95/1200/1300/1400/ 1500/1600/1700/1900 LF 55
<b>0196424</b> 	<b>1319838</b> 0311300 0607998 1315447 1338714 MAK1295 1407394	L=115  M=30x1,5 LHT	CF 65 - CF 75 - CF 85 - 45 - F 1100 - F 1200-F 1300
<b>0289927</b> 	<b>1344684</b>	L=115  M=24X1,5 RHT	75CF-85CF-95XF-XF95
<b>0189926</b> 	<b>1401944</b>	L=120  M=30 x1,5 RHT	LF 45 FA
<b>0187146</b> 	<b>0069867</b> 0161376 0608000	L=120  M=30x1,5 RHT	F 1600FA/FGG/FT/FAV F 1800
<b>0187785</b> 	<b>NAK3395</b>	L=120  M=30X1,5 RHT	LEYLAND DAF: CONSTRUCTOR (8x2, 8x4) (6x2, 6x4) FA 50 (17&18 tons) FA 60-FA 80 FREIGHTER (15,16 & 17 tons) LYNX OLYMPIAN ROADRUNNER ROADTRAIN T 45, TIGER

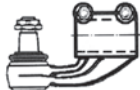
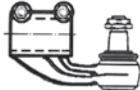
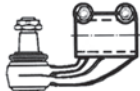
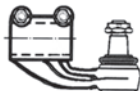

**TESTE STERZO - TIE RODS END**

RIF. OCAP OCAP REF.	RIF. ORIG O.E. NUMBER	NOTE REMARKS	MODELLO / DESCRIZIONE MODEL / DESCRIPTION
<b>0197785</b>  	<b>NAK3394</b>	L=120  M=30X1,5 LHT	LEYLAND DAF: CONSTRUCTOR (8x2, 8x4) (6x2, 6x4) CF 75 - CF 85 F 500 - F 600 - F800 - F 900 FA 50 (17&18 tons) - FA 60-FA 80 FREIGHTER (15,16 & 17 tons) LYNXOLYMPIAN - ROADRUNNER ROADTRAIN T 45, TIGER
<b>0186598</b>  	<b>1257890</b> 0607981 0698450 0696226 1603789 1149907 1152350 1618048	L=120  M=30x1,5 RH	F1000 > F2300 - F500 > F900 F2500 - F2700 65 - 75 - 85 CF CF75 - 85 - F75 - 89 -95 95XF - XF 95 - XF 105
<b>0196598</b>  	<b>1228115</b> 0607053 1329134 0696225	L=120  M=30x1,5 LHT	F1000 > F2300 - F500 > F900 F2500 - F2700 65 - 75 - 85 CF CF75 - 85 - F75 - 89 -95 95XF - XF 95 - XF 105
<b>0197928</b>  	<b>1401942</b> AFRA635	L=120  M=30x1,5 LHT	LF 45 FA
<b>0286427</b>  	<b>0606923</b> 606923	L=130  M=46x1,5 RH	95 XF F 95/1600/1700/1900 F 2000/2100/2105/2200 F 2300/ 2305/2500/2505/2600 F 2700/2800/2900 F 3200/3300/3305/3600 TT 2100
<b>0296427</b>  	<b>0606922</b> 606922	L=130  M=46x1,5 LHT	95 XF F 95/1600/1700/1900 F 2000/2100/2105/2200 F 2300/ 2305/2500/2505/2600 F 2700/2800/2900 F 3200/3300/3305/3600 TT 2100
<b>0286428</b>  	<b>0067389</b> 67389	L=130  M=48x1,5 RHT	65-75 (4x2) 85 (4x2-6x2-6x4-8x2-8x4) 95 (4x2-6x2-6x2 T.Unit Twinteer) 65/75/85 CF - 95 XF CF 65/75/85 F 65/75/85/95 - FT 95
<b>0296428</b>  	<b>0067303</b> 67303	L=130  M=48x1,5 LHT	65-75 (4x2) 85 (4x2-6x2-6x4-8x2-8x4) 95 (4x2-6x2-6x2 T.Unit Twinteer) 65/75/85 CF - 95 XF CF 65/75/85 F 65/75/85/95 - FT 95

**TESTE STERZO - TIE RODS END**

RIF. OCAP OCAP REF.	RIF. ORIG O.E. NUMBER	NOTE REMARKS	MODELLO / DESCRIZIONE MODEL / DESCRIPTION
<b>0297796</b> 	<b>1205248</b>	L=133  M=52x1,5 RHT	75- 85- 95 XF 75 - 85 CF F 75 - 85 - 95
<b>0287724</b> 	<b>1235514</b>	L=133  M=52x1,5 RHT	75- 85- 95 XF 75/85 CF - F 75/85/95
<b>0297724</b> 	<b>1235515</b>	L=133  M=52x1,5 LHT	75- 85- 95 XF 75/85 CF - F 75/85/95
<b>0186758</b> 	<b>0609643</b> 0122810 0586714 0607073 0609634 0696226	L=135  M=30x1,5 RHT	F 95/1600 F 2000/2100/2200/2300/2500/2700/2800 F 3300/3600
<b>0187463</b> 	<b>0697221</b>	L=135  M=38x1,5 RHT	
<b>0199928</b> 	<b>1310760</b> 1603418	L=141  M=30x1,5 LHT	85 - 85CF
<b>0187843</b> 	<b>1389190</b>	L=141  M=30x1,5 RHT	85CF - CF75 - CF95 95XF - XF95 - XF105
<b>0187894</b> 	<b>1785340</b>	L=145  M=30x1,5 RH	CF75 - CF85 - XF105

**TESTE STERZO - TIE RODS END**





RIF. OCAP OCAP REF.	RIF. ORIG O.E. NUMBER	NOTE REMARKS	MODELLO / DESCRIZIONE MODEL / DESCRIPTION
<b>0187929</b> 	<b>1604248</b> 1705907 1902997 1703472	L=148  M=28x1,5 RHT	LF 45 FA
<b>0197929</b> 	<b>1703473</b> 1705908 1902996 1604247	L=148  M=28x1,5 LHT	LF 45 FA
<b>0187723</b> 	<b>1603883</b>	L=150  M=30x1,5 RHT	
<b>0187530</b> 	<b>0698586</b>	L=150  M=38x1,5 RHT	
<b>0289929</b> 	<b>6K13312</b> EAX1458 PAX1459	L=155  M=W1"11/16x1 2 RHT	BMC: FATIH-BISON-BUFFALO-CLYDESDALE-CR UISER CONSTRUCTOR-REIVER-BOZER BX1425/1600-MASTIFF-ROADTRAIN
<b>0299929</b> 	<b>PAX1458</b> 6K13313 EAX1459	L=155  M=W1"11/16x1 2 LHT	BMC: FATIH-BISON-BUFFALO-CLYDESDALE-CR UISER CONSTRUCTOR-REIVER-BOZER BX1425/1600-MASTIFF-ROADTRAIN
<b>0197523</b> 	<b>0638680</b>	L=160  M=38x1,5 LHT	
<b>0287519</b> 	<b>0608122</b> 608122	L=174  M=45x1,5 RHT	F1700/1900/2000/2100/2200/ 2300/2500/2700/2800 TT 2100

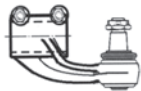
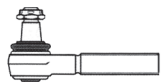
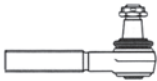



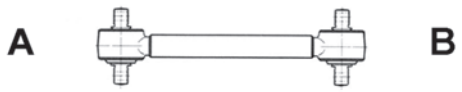
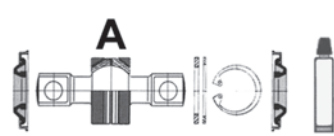

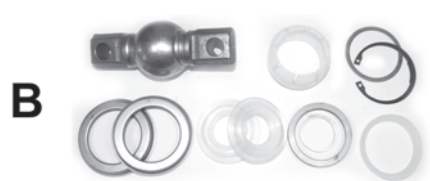
**TESTE STERZO - TIE RODS END**

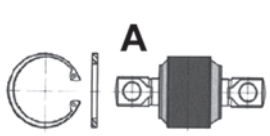
RIF. OCAP OCAP REF.	RIF. ORIG O.E. NUMBER	NOTE REMARKS	MODELLO / DESCRIZIONE MODEL / DESCRIPTION
<b>0297519</b>  	<b>0608123</b> 608123	L=174  M=45x1,5 LHT	F1700/1900/2000/2100/2200/ 2300/2500/2700/2800 TT 2100
<b>0187803</b>  	<b>ACU9240</b> AFRA888	L=180  M=28x1,5 RHT	45: FA 45.120/45.130/150/160/180/210 FA 1900
<b>0197803</b>  	<b>ACU9239</b>	L=180  M=28x1,5 LHT	45: FA 45.120/45.130/150/160/180/210 FA 1900



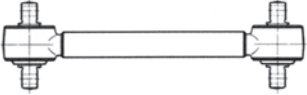
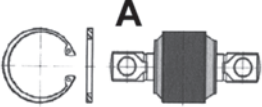

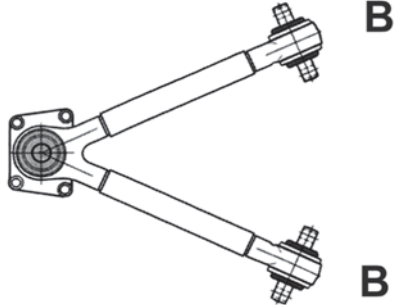
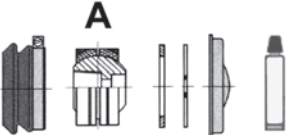

**BARRE DI REAZIONE - TORQUE RODS**

RIF. OCAP OCAP REF.	RIF. ORIG O.E. NUMBER	NOTE REMARKS	MODELLO / DESCRIZIONE MODEL / DESCRIPTION
<p><b>0807555</b></p> 	<b>1261101</b>	<p>L=390 T=50</p> <p>d1=21 - d2=19</p>	<p>SERIE 95 75 CF - 95 XF CF 85 - F 95 - XF 95 - XF 105</p>
<p><b>0907556</b></p> 	<b>0693778</b>	<p>l=152 p=24 D=65 d=21</p>	
<p><b>0907586</b></p> 	<b>0005861533</b>	D=65	senza perno (without pin)
<p><b>0907258</b></p> 	<p><b>1271124</b> 2980884 81432206132 81432206108</p>	<p>l=130 p=30 D=65 d=19</p>	
<p><b>0907757</b></p> 	-	D=65	senza perno (without pin)
<p><b>0807797</b></p> 	<p><b>1284860</b> 0655695 0655697 0646373 1620438</p>	<p>L=600</p> <p>d=21</p>	<p>FT - FTG - FTR - FTS - FTT - XT XF FT - XF FTG - XF FTR - XF FTS XF TT - F2800 -F3300</p>
<p><b>0907359</b></p> 	<p><b>0691709</b> 0513757</p>	<p>l=130 p=30 D=70 d=21</p>	

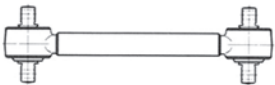
**BARRE DI REAZIONE - TORQUE RODS**

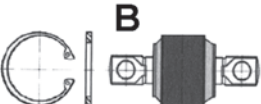
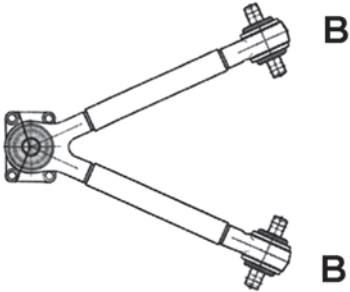

RIF. OCAP OCAP REF.	RIF. ORIG O.E. NUMBER	NOTE REMARKS	MODELLO / DESCRIZIONE MODEL / DESCRIPTION
<p><b>0807501</b></p>  <p><b>0907359</b></p> 	<p><b>0267743</b> 1361650</p> <p><b>0691709</b> 0513757</p>	<p>L=605 T=48  d=21</p> <p>I=130 p=30 D=70 d=21</p>	<p>65/75/85/95 CF - 95 XF CF 380 1999 &gt;.... F 65/75/85/95 XF 95</p>
<p><b>0807927</b></p>  <p><b>0907927</b></p> 	<p><b>1294251</b></p> <p><b>1321936</b></p>	<p>L=606</p> <p>p=24 D=67 d=19</p>	<p>75CF-85FTG-CF75-CF85</p>
<p><b>0807489</b></p>  <p><b>0907487</b></p>  <p><b>0907489</b></p> 	<p><b>0080521</b> 16170096 1368270 1361651 1390932</p> <p><b>0069600</b> 0691704</p> <p><b>0698724</b></p>	<p>L=608 T=48  d=23</p> <p>IK=38  D=65</p> <p>L=152 d=23 p=24 D=70</p>	<p>CF - FT - FTG - FTT - FTS - FTR XF - CF</p>

BARRE DI REAZIONE - TORQUE RODS







RIF. OCAP OCAP REF.	RIF. ORIG O.E. NUMBER	NOTE REMARKS	MODELLO / DESCRIZIONE MODEL / DESCRIPTION
<p><b>0807507</b></p> <p><b>A</b>  <b>A</b></p>	<p><b>0296110</b> 296110 X50561</p>	<p>L=680</p> <p>d=19</p>	
<p><b>0907259</b></p> <p><b>A</b>  <b>A</b></p>	<p><b>0689749</b></p>	<p>l=130 p=30 D=70 d=19</p>	
<p><b>0807513</b></p> <p><b>A</b>  <b>B</b></p> <p> <b>0187530</b> M=38x1,5 RHT</p>	<p><b>0392418</b></p>	<p>L=862</p> <p>d=19</p>	<p>MBG 200/230 SB 230/270/300/2300/2700/3000 SR 300/301</p>
<p><b>0907508</b></p> <p><b>A</b>  <b>A</b></p>	<p><b>1208073</b></p>	<p>D=55</p> <p>K=38</p>	
<p><b>0907327</b></p> <p><b>B</b>  <b>B</b></p>	<p><b>0067354</b></p>	<p>l=130 p=24 D=62 d=19</p>	
<p><b>0807528</b></p> <p><b>A</b>  <b>B</b></p>	<p><b>0658102</b></p>	<p>L=870</p> <p>d=17</p>	<p>75/85 CF - 95 XF CF 75/85 - XF 95</p>
<p><b>0907531</b></p> <p><b>A</b>  <b>A</b></p>	<p><b>0689747</b></p>	<p>D=70</p> <p>K=45</p>	





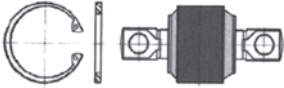

**BARRE DI REAZIONE - TORQUE RODS**

RIF. OCAP OCAP REF.	RIF. ORIG O.E. NUMBER	NOTE REMARKS	MODELLO / DESCRIZIONE MODEL / DESCRIPTION
<p><b>0807930</b></p> 	<p><b>1793876</b> 1620436 1361652</p>	<p>L=608,2 T=48  d=23</p>	<p>75 CF - CF 75 - CF 85</p>
<p><b>0907525</b></p> 	<p><b>0696320</b></p>	<p>L=61  IK=56 D=80</p>	
<p><b>0907489</b></p> 	<p><b>0698724</b></p>	<p>L=152 d=23 p=24 D=70</p>	

**KIT DI SOSPENSIONE - SUSPENSION KITS**

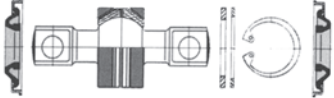

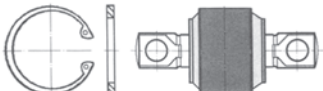
RIF. OCAP OCAP REF.	RIF. ORIG O.E. NUMBER	NOTE REMARKS	MODELLO / DESCRIZIONE MODEL / DESCRIPTION
<b>0907525</b> 	<b>0696320</b>	L=61  IK=56 D=80	95 F 2100-2300-2500-2700 75CF-CF75-CF85
<b>0907489</b> 	<b>0698724</b>	L=152 d=23 p=24 D=70	75 CF - CF 75 - CF 85
<b>0907508</b> 	<b>1208073</b>	D=55  K=38	MBG 200/230 SB 230/270/300/2300/2700/3000 SR 300/30175/85 CF F17/19/21/23/25/75/85/95 TT2100
<b>0907327</b> 	<b>0067354</b>	l=130 p=24 D=62 d=19	MBG 200/230 SB 230/270/300/2300/2700/3000 SR 300/30175/85 CF F17/19/21/23/25/75/85/95 TT2100
<b>0907528</b> 	<b>0689748</b>	l=115 p=24 D=62 d=17	75 - 85 CF - CF 75 - 85 95 XF - XF 95
<b>0907925</b> 	<b>1445656</b>		65 CF-75 CF-CF 65-CF 75-CF 85-LF 45-LF 55
<b>0907926</b> 	<b>1398368</b>		65 CF-75 CF-85 CF-85 FT-95 FA-95 FT 95 XF-CF 85-F 2300-LF 45
<b>0907927</b> 	<b>1321936</b>	p=24 D=67 d=19	75 CF-75 FA-85 CF-85 FA-85 FT

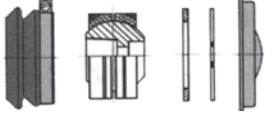
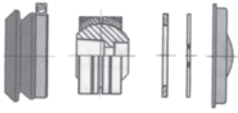
**KIT DI SOSPENSIONE - SUSPENSION KITS**



RIF. OCAP OCAP REF.	RIF. ORIG O.E. NUMBER	NOTE REMARKS	MODELLO / DESCRIZIONE MODEL / DESCRIPTION
<b>0907997</b> 	<b>1243618</b>	l=115 p=24 D=67 d=17	CF 75-85 - XF 95-105
<b>0907556</b> 	<b>0693778</b>	l=152 p=24 D=65 d=21	95 FA/FAD/FAG/FAK/FAR /FAT/FT/FTG/FTT 95 XF FA/FAC/FAD/FAR/FAS /FAT/FT/FTG/FTR/FTS/FTT F 2800- F 3300
<b>0907531</b> 	<b>0689747</b>	D=70  K=45	
<b>0907259</b> 	<b>0689749</b>	l=130 p=30 D=70 d=19	
<b>0907359</b> 	<b>0691709</b> 0513757	l=130 p=30 D=70 d=21	FT - FTG - FTR - FTS - FTT - XT XF FT - XF FTG - XF FTR - XF FTS XF TT - F2800 -F3300 65/75/85 CF - 95 XF CF 65/75/85 F 95 - XF 95
<b>0907529</b> 	<b>0696321</b>	l=152 p=35 D=80 d=23	65-75-85-95 F2000-2100-2200-2300-2500 2600-2700-2800-2900-3200 3300-3600
<b>0907257</b> 	<b>0691704</b>	L=50 IK=38  D=65	75 - 85 CF F75 - 85 - 95 95XF F1900 - 2300 - 2700
<b>0907297</b> 	<b>1376730</b>	IK=38  D=65	65 - 75 - 85 CF 95XF F2700





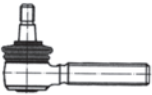

**KIT DI SOSPENSIONE - SUSPENSION KITS**

RIF. OCAP OCAP REF.	RIF. ORIG O.E. NUMBER	NOTE REMARKS	MODELLO / DESCRIZIONE MODEL / DESCRIPTION
<p><b>0907304</b></p> 	<p><b>0691703</b></p>	<p>l=152 p=24 D=70 d=21</p>	<p>F2100 - F2300 - F2500 - F2800 F2900 - F3200 - F3300 - F3600</p>
<p><b>0907686</b></p> 	<p><b>696321</b> 0696321</p>	<p>l=152 p=24 D=80 d=23</p>	<p>F2100 - F2300 - F2500 - F2800 F2900 - F3200 - F3300 - F3600 65 - 75 - 85 CF F75 - 85 - 95 - 95XF</p>

**TESTE COMANDO CAMBIO - GEAR BOX CONTROL BALL JOINTS**

RIF. OCAP OCAP REF.	RIF. ORIG O.E. NUMBER	NOTE REMARKS	MODELLO / DESCRIZIONE MODEL / DESCRIPTION
<b>0287229</b>  	<b>589333</b> 656085 1249129	L=55  M=12x1,75 RH	65/75/85 CF - 95 XF F
<b>0297229</b>  	<b>1249088</b> 0592106 0656084	L=55  M=12x1,75 LH	65/75/85 CF - 95 XF F
<b>0187228</b>  	<b>386930</b> 0386930	L=85  M=14 x 1,5 RH	95 XF - F

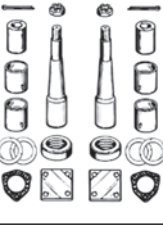
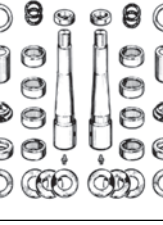

**KIT PERNO FUSO - KING PIN SET**

RIF. OCAP OCAP REF.	RIF. ORIG O.E. NUMBER	NOTE REMARKS	MODELLO / DESCRIZIONE MODEL / DESCRIPTION
<b>0927398</b>  	<b>0206137</b> 206137	L=247  D=33/41	1958 > 71 - F2900-F2000-F2003 1958 > 71 - A2004 1963 > 71 - AE2300-AE2600 1968 > 71 - F1600-FA2500-FT2500-FA2000-FT2000 1975 > - F2100-F2105 1978 > - SB2000-SB2005
<b>0927399</b>  	<b>0100873</b> 100873	L=245  D=30/41	1971 > - FA1400-FT1400 1968 > - FA1600-FT1600-FAS1600 1975 > - F1300-F1500
<b>0927400</b>  	<b>0548588</b> 548588	L=265  D=31/41	1958 > 71 - 1900-2000-2003-A2004 1963 > 71 - AE2300-AE2600 1968 > - FAT/FM/FAS2000 - FM/FAS/FAT2005 1968 > - FA/FT/FAS/FAT2200 1968 > - FA/FT/FAS/FAT2205 1968 > 1974 - FT2600 1968 > 1974 - FA/FT/FAS/FAT/FTT2605 1974 > - AT2400/ATE2400/FAZ2205 1975 > - F2800/F2805 - MB200
<b>0927401</b>  	<b>0118086</b> 118086	L=275  D=31,5/50	1974 > - FA/FAS/FAT/FFT/FAR/FTS/FT2800 1974 > - N2800 1974 > - FA/FAS/FAT/FTT/FAR/FT2805 1975 > - F/FAS/FAT/FM200 1975 > - F/FAS/FAT/FM2005 1975 > - F2100-F2105-F2200-F2205-F2300-F2305 1975 > - MB200 - F3300 - F3305
<b>0927402</b>  	<b>0681621</b> 681621 0680374 680374	L=270  D=31,5/50	1980 > - F1600-F2100-F2105-F2300-F2305 1980 > - F2500-F2505-F2800-F3300-F3305 1980 > - SB2300-SB2305-SB3000 F2800-F2805-MBG 1981 > - MB200-MB230-SB201-SB210 1986 > - TB2100-F3600-N3300
<b>0927403</b>  	<b>0681706</b> 681706	L=270  D=31,5/50	65/75/85 CF - 95 XF XF 95

**KIT PERNO FUSO - KING PIN SET**

RIF. OCAP OCAP REF.	RIF. ORIG O.E. NUMBER	NOTE REMARKS	MODELLO / DESCRIZIONE MODEL / DESCRIPTION
<p><b>0927404</b></p> 	<p><b>0681511</b> 681511</p>	<p>L=265</p> <p>D=31,5/45</p>	<p>85 CF 1986 &gt; F 95/1100/1300/1700/1900</p>

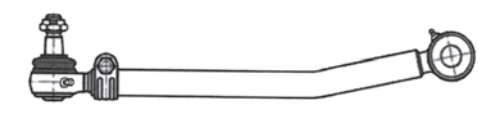
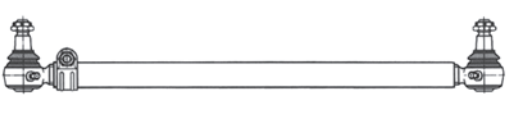
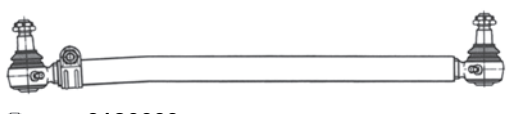
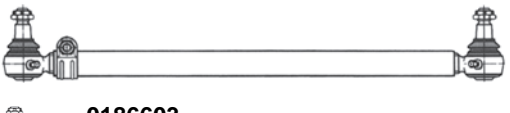

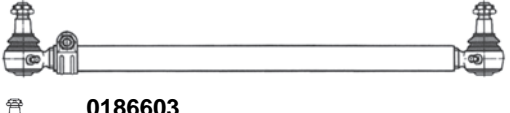

**TIRANTI LONGITUDINALI - DRAG LINKS**

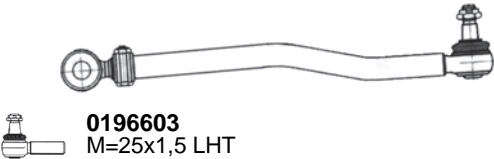
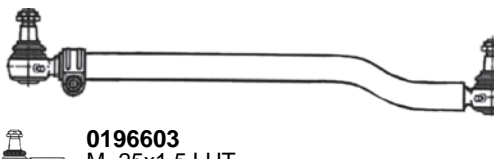
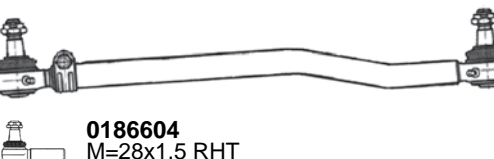
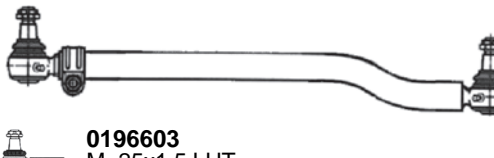
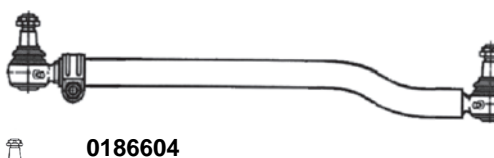
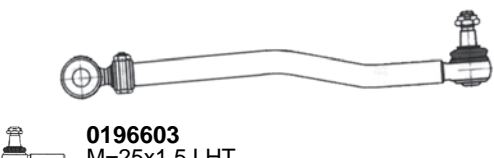
RIF. OCAP OCAP REF.	RIF. ORIG O.E. NUMBER	NOTE REMARKS	MODELLO / DESCRIZIONE MODEL / DESCRIPTION
<p><b>0506712</b></p>  <p><b>0186605</b> M=38x1,5 RHT</p>	<p><b>4520694</b> 4669091</p>	<p>L=462</p>	<p>180NC/NT/NTS 690N1//N2/N3/N4/T2 691N/T/TS</p>
<p><b>0506733</b></p>  <p><b>0196603</b> M=25x1,5 LHT</p>	<p><b>8526148</b> 8558647</p>	<p>Lt=590</p>	<p>OM: LEONCINO LUPETTO CERBIATTO</p>
<p><b>0506991</b></p>  <p><b>0186603</b> M=25x1,5 RHT</p>	<p><b>8535664</b> 8558651</p>	<p>Lt=590</p>	<p>OM: LUPETTO 2 serie Q.li</p>
<p><b>0507171</b></p>  <p><b>0186603</b> M=25x1,5 RHT</p>	<p><b>8533963</b></p>	<p>Lt=615</p>	<p>OM: DAINO TIGROTTO MA TIGROTTO 50-55Q.li</p>
<p><b>0506753</b></p> 	<p><b>4520698</b> 4669094</p>	<p>L=857</p>	<p>180NC/NT/NTS 690N1//N2/N3/N4/T2 691N/T/TS</p>
<p><b>0506993</b></p>  <p><b>0186603</b> M=25x1,5 RHT</p>	<p><b>8525704</b></p>	<p>Lt=640</p>	<p>OM: TIGROTTO M3</p>

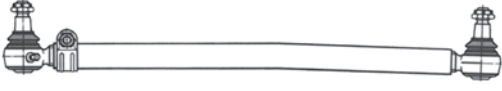
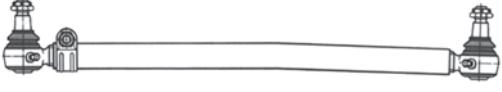

**TIRANTI LONGITUDINALI - DRAG LINKS**

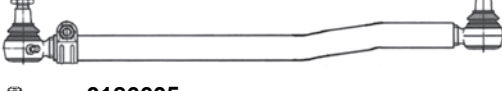
RIF. OCAP OCAP REF.	RIF. ORIG O.E. NUMBER	NOTE REMARKS	MODELLO / DESCRIZIONE MODEL / DESCRIPTION
<p><b>0506977</b></p>  <p><b>0196603</b> M=25x1,5 LHT</p>	<b>4568702</b>	Lt=705	650 E - 662 N
<p><b>0506976</b></p>  <p><b>0196603</b> M=25x1,5 LHT</p>	<b>4588688</b>	Lt=707	645N1 650N1 662N1
<p><b>0506711</b></p>  <p><b>0186604</b> M=28x1,5 RHT</p>	<b>4665501</b>	Lt=732	673N/T 130NC/NR/NT veicolo a cabina fissa (vehicle with fixed compartment)
<p><b>0506710</b></p>  <p><b>0196603</b> M=25x1,5 LHT</p>	<b>4665209</b>	Lt=745	100NC-110NC 662N3/T-672N veicoli con servosterzo (vehicles with power steering)
<p><b>0506714</b></p>  <p><b>0186604</b> M=28x1,5 RHT</p>	<b>4692686</b>	Lt=770	110NC v.837TILT.CAB 130NC
<p><b>0506709</b></p>  <p><b>0196603</b> M=25x1,5 LHT</p>	<b>4665085</b> 4626917	Lt=775	100NC-110NC e deriv. 645N2/N3 650N2/N3 655N/N1 662N2/N3/T-672N

**TIRANTI LONGITUDINALI - DRAG LINKS**

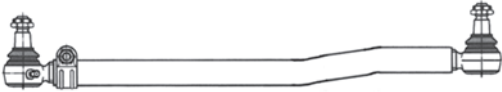
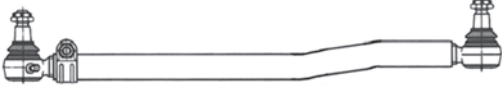
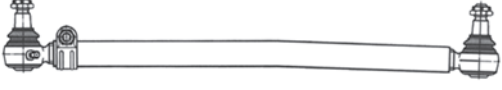
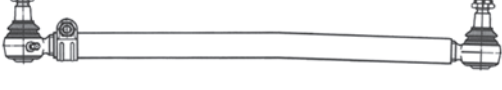

RIF. OCAP OCAP REF.	RIF. ORIG O.E. NUMBER	NOTE REMARKS	MODELLO / DESCRIZIONE MODEL / DESCRIPTION
<p><b>0507153</b></p>  <p><b>0186604</b> M=28x1,5 RHT</p>	<b>8558653</b>	Lt=775	OM 120
 <p><b>0186603</b> M=25x1,5 RHT</p>	<b>8788387</b>	Lt=825	100.13-100.F13 100EC-OMN100/10
 <p><b>0196603</b> M=25x1,5 LHT</p>	<b>8788641</b>	Lt=825	100F13 OM 120-OMN 100
 <p><b>0186604</b> M=28x1,5 RHT</p>	<b>4546822</b> 4573092	Lt=830	643N/N1
 <p><b>0186605</b> M=38x1,5 RHT</p>	<b>4574457</b>	Lt=845	683N-619N
 <p><b>0186605</b> M=38x1,5 RHT</p>	<b>4545422</b>	Lt=855	693N1/T1

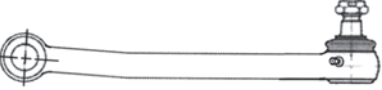
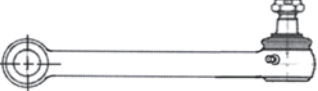
TIRANTI LONGITUDINALI - DRAG LINKS



RIF. OCAP OCAP REF.	RIF. ORIG O.E. NUMBER	NOTE REMARKS	MODELLO / DESCRIZIONE MODEL / DESCRIPTION
<p><b>0506720</b></p>  <p><b>0186605</b> M=38x1,5 RHT</p>	<p><b>4624032</b> 4732546 4666954</p>	<p>Lt=855</p>	<p>300PC/PT 619NI/NIP/TI/TIP 697N/NP/T/TP</p>
<p><b>0506721</b></p>  <p><b>0186605</b> M=38x1,5 RHT</p>	<p><b>4667156</b> 4732549 4624116</p>	<p>Lt=855</p>	<p>300PC/PT 619NI/NIP/TI/TIP 697N/NP/T/TP</p>
<p><b>0506750</b></p>  <p><b>0186605</b> M=38x1,5 RHT</p>	<p><b>4666991</b> 4733704</p>	<p>Lt=857</p>	<p>160NC/R 684N/NP/T/TP OM 160/T</p>
<p><b>0506723</b></p>  <p><b>0186605</b> M=38x1,5 RHT</p>	<p><b>4666933</b> 4733752</p>	<p>Lt=857</p>	<p>160NC/R 684N/NP/T/TP</p>
<p><b>0507155</b></p>  <p><b>0186605</b> M=38x1,5 RHT</p>	<p><b>7136367</b></p>	<p>Lt=860</p>	<p>150N</p>
<p><b>0506971</b></p> 	<p><b>4668258</b></p>		<p>180NC/NT/NTS 691N/T/TS</p>
<p><b>0506984</b></p> 	<p><b>4520744</b> 4668402</p>	<p>L=865</p>	<p>690N1/N2/N3/N4</p>

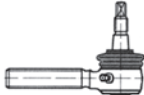
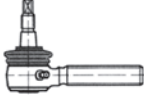
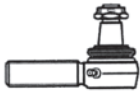

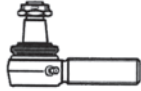
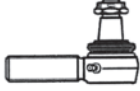
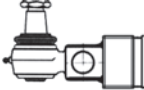
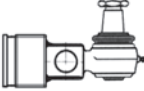

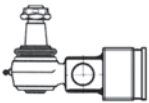
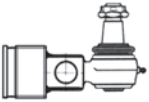

**TESTE STERZO - TIE RODS END**

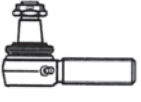
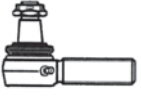
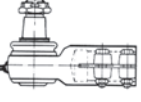
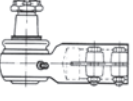
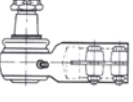
RIF. OCAP OCAP REF.	RIF. ORIG O.E. NUMBER	NOTE REMARKS	MODELLO / DESCRIZIONE MODEL / DESCRIPTION
<b>0286659</b>  	<b>4536229</b> 4668368	L=82  m=24x1,5	180NC/NT/NTS 690N1/N2/N3/N4 691N/T/TS  Servosterzo (Power steering)
<b>0186601</b>  	<b>814304</b>	L=83  M=16x1 RHT	616 N1/N2/N3/N4 OM 616
<b>0196601</b>  	<b>814305</b>	L=83  M=16x1 LHT	616 N1/N2/N3/N4 OM 616
<b>0186603</b>  	<b>4018036</b> 4663787	L=115  M=25x1,5 RHT	100.13/F13-100.14 110NC-100EC-100NC-314/3 OMN 100/10 LUPETTO-LEONCINO CERBIATTO-DAINO TIGROTTO
<b>0196603</b>  	<b>4018037</b> 4663791	L=115  M=25x1,5 LHT	100.13/F13-100.14 110NC-100EC-100NC-314/3 OMN 100/10 LUPETTO-LEONCINO CERBIATTO-DAINO TIGROTTO
<b>0186604</b>  	<b>4028250</b> 4663972	L=117  M=28x1,5 RHT	110 NC var 837 TILT 643N/N1 673N-130NC 130NR-130NT
<b>0196604</b>  	<b>4028251</b> 4663974	L=117  M=28x1,5 LHT	110 NC var 837 TILT 643N/N1 673N-130NC 130NR-130N
<b>0186653</b>  	<b>4664343</b> 4544893	L=118  M=64x1,5 RHT	160NC/NT-300PC 619N1/N1P-697N/NP 684N/NP/T/TP  Servosterzo (Power steering)
<b>0186651</b>  	<b>4664345</b> 4562450	L=118  M=64x1,5 RHT	160NC/NT-300PC 619N1/N1P-697N/NP 684N/NP/T/TP  Servosterzo (Power steering)

**TESTE STERZO - TIE RODS END**

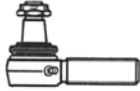
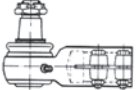
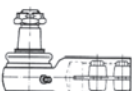
RIF. OCAP OCAP REF.	RIF. ORIG O.E. NUMBER	NOTE REMARKS	MODELLO / DESCRIZIONE MODEL / DESCRIPTION
<b>0186649</b> 	<b>4665005</b>	L=120  M=64x1,5 RHT	100 F13/-NC-110NC-130NC/NR/NT 645N/N1-650E-650N/N1/N2/N3 655N/N1-662N/N2/N3-673N  Servosterzo (Power steering)
<b>0186648</b> 	<b>4665007</b>	L=120  M=64x1,5 RHT	100 F13/-NC-110NC-130NC/NR/NT 645N/N1-650E-650N/N1/N2/N3 655N/N1-662N/N2/N3-673N  Servosterzo (Power steering)
<b>0186605</b> 	<b>4664297</b> 4510019 4664292 4510620	L=130  M=38x1,5 RHT	180NC/NT/NTS 682N2/N3/N4 682T2/T3/T4 683/619N 690N1/N2/N3/N4 691N/T/TS-693N/N1
<b>0196605</b> 	<b>4523292</b> 4664295	L=130  M=38x1,5 LHT	682N2/N3/N4 682T2/T3/T4-683N 619N-693N/N1
<b>0186657</b> 	<b>4520697</b> 4664586	L=130  M=38x1,5 RHT	180NC-180NT-180NTS 690N1/N2/N3/N4-691N1/TS
<b>0186684</b> 	<b>4580778</b>	L=130  M=38x1,5 RHT	682N2/N3/N4 682T2/T3/T4  Servosterzo (Power steering)
<b>0286647</b> 	<b>4665009</b>	L=130  M=30x1,5 RHT	100 F13/-NC-110NC-130NC/NR/NT 645N/N1-650E-650N/N1/N2/N3 655N/N1-662N/N2/N3-673N  Servosterzo (Power steering)
<b>0287150</b> 	<b>4664090</b>	L=130  M=30x1,5 RHT	643N/N1 Servosterzo (Power Steering)
<b>0287151</b> 	<b>4664092</b> 4664088	L=130  M=30x1,5 RHT	643N/N1  Servosterzo (Power steering)



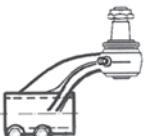



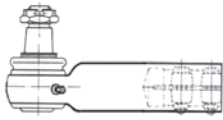



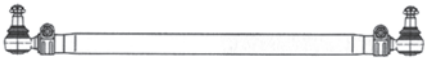





**TESTE STERZO - TIE RODS END**

RIF. OCAP OCAP REF.	RIF. ORIG O.E. NUMBER	NOTE REMARKS	MODELLO / DESCRIZIONE MODEL / DESCRIPTION
<b>0187152</b>  	<b>4580782</b>	L=130  M=38x1,5 RHT	682N2/N3/N4 682T2/T3/T4  Servosterzo (Power steering)
<b>0286652</b>  	<b>4582159</b> 4664462	L=138  M=30x1,5 RHT	160NC/NT/-300PC/PT 619N1/N1P-697NP-684N/NP/T/TP  Servosterzo (Power steering)
<b>0286650</b>  	<b>4514245</b> 4664460	L=138  M=30x1,5 RHT	160NC/NT-300PC 684AN/NP/T/TP-690N1/N2/N3/N4 619N1/N1P-697N/NP TESTA ANT.LHD TIEROD END FRONT LHD Servosterzo (Power steering)
<b>0286665</b>  	<b>4025438</b>	L=138  M=30x1,5 RHT	682N2/N3/N4 682T2/T3/T4  Servosterzo (Power Steering)
<b>0286666</b>  	<b>4533777</b>	L=138  M=30x1,5 RHT	682N2/N3/N4 682T2/T3/T4  Servosterzo (Power Steering)
<b>0286606</b>  	<b>4510017</b> 4664349	L=175  M=45x1,5 RHT	180NC/NT/NTS 682N2/N3/N4 682T2/T3/T4 690N1/N2/N3/N4 691N/TS
<b>0296606</b>  	<b>4510018</b> 4664347	L=175  M=45x1,5 LHT	180NC/NT/NTS 682N2/N3/N4 682T2/T3/T4 690N1/N2/N3/N4 691N/TS
<b>0286610</b>  	<b>4664353</b> 4732041 4514235	L=190  M=52x1,5 RHT	160NC/NT/R 300PC/PT 619NI/NIP/TI/TIP 684N/NP/T/TP 697N/NP/T/TP





**TESTE STERZO - TIE RODS END**

RIF. OCAP OCAP REF.	RIF. ORIG O.E. NUMBER	NOTE REMARKS	MODELLO / DESCRIZIONE MODEL / DESCRIPTION
<b>0296610</b>  	<b>4664351</b> 4732042 4514236	L=190  M=52x1,5 LHT	160NC/NT/R 300PC/PT 619NI/NIP/TI/TIP 684N/NP/T/TP 697N/NP/T/TP
<b>0286658</b>  	<b>4665422</b> 4668206	L=200  M=30x1,5 RHT	180NC/NT/NTS 691N/T-691TS  Servosterzo (Power Steering)





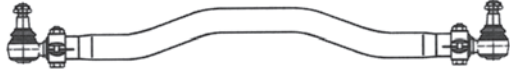
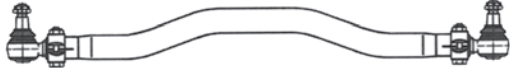

## BARRE ACCOPPIAMENTO - TIE RODS

RIF. OCAP OCAP REF.	RIF. ORIG O.E. NUMBER	NOTE REMARKS	MODELLO / DESCRIZIONE MODEL / DESCRIPTION
<b>0506613</b>   <b>0186613</b> M=28x1,5 RHT <b>0196613</b> M=28x1,5 LHT 	<b>60103171</b>	L=1346	90-17WM 75-13 AWM
<b>0507290</b>   <b>0186613</b> M=28x1,5 RHT <b>0196613</b> M=28x1,5 LHT 	<b>8582320</b> 8564386	L=1348	ZETA: 50-9H/V 60.11/V 65.9 65.12/H/V 79.12/H/V 79.14/H/V A 60.9
<b>0506904</b>   <b>0186613</b> M=28x1,5 RHT <b>0196613</b> M=28x1,5 LHT 	<b>86012923</b> 42037386 7166166	L=1404	80.13 - 80.16 - 90.13
<b>0507323</b>   <b>0186595</b> M=24x1,5 RHT <b>0196595</b> M=24x1,5 LHT 	<b>86012924</b>	L=1424	MK: 75-9A/H 80-9A/AH
<b>0506542</b>   <b>0186608</b> M=28x1,5 RHT <b>0196608</b> M=28x1,5 LHT 	<b>7166384</b>	L=1455	115.14/.17 135.14/.17 145.17
<b>0506955</b>   <b>0186598</b> M=30x1,5 RHT	<b>42118693</b> 42117267 42118781	L=1458	EUROCARGO: 95E15/E21 135E18/E23 TECTOR: 150E24 EUROFIRE TECTOR: 140E28

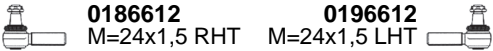

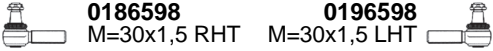
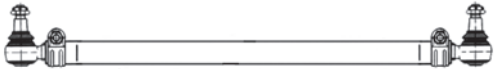
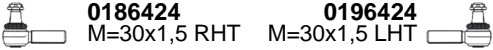
**BARRE ACCOPPIAMENTO - TIE RODS**

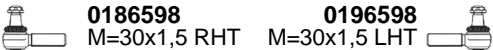
RIF. OCAP OCAP REF.	RIF. ORIG O.E. NUMBER	NOTE REMARKS	MODELLO / DESCRIZIONE MODEL / DESCRIPTION
<p><b>0507366</b></p>  <p><b>0186598</b>      <b>0196598</b> M=30x1,5 RHT    M=30x1,5 LHT</p>	<p><b>41032608</b> 41033237</p>	<p>L=1477 T=48</p>	<p>EUROSTAR LD 240 - EUROTECH MP 240 - STRALIS AD 260-AS 260</p>
<p><b>0506950</b></p>  <p><b>0186424</b>      <b>0196424</b> M=30x1,5 RHT    M=30x1,5 LHT</p>	<p><b>98402553</b> 500307556</p>	<p>L=1490</p>	<p>EUROCARGO - TECTOR - TECTOR RETYLING</p>
<p><b>0506827</b></p>  <p><b>0186424</b>      <b>0196424</b> M=30x1,5 RHT    M=30x1,5 LHT</p>	<p><b>86011651</b> 42037384 86018015 42064639</p>	<p>L=1506</p>	<p>110-13A/AH 110-16A/AH/AT 130-13A/AH 130-16A/AH 130M11FL</p>
<p><b>0506818</b></p>  <p><b>0186598</b>      <b>0196598</b> M=30x1,5 RHT    M=30x1,5 LHT</p>	<p><b>42100262</b> 2478910 42037040 42037041 42100263 42100703</p>	<p>L=1524 T=60</p>	<p>170.23 AHW 160.23/.60 AHW 170 190.25AN 190.26 260.25/34 300.26/30/36</p>
<p><b>0507312</b></p>  <p><b>0186598</b>      <b>0186598</b> M=30x1,5 RHT    M=30x1,5 RHT</p>	<p><b>42102633</b></p>	<p>L=1524</p>	<p>190-30H 260-34AH 330-30AN/H/N</p>
<p><b>0507302</b></p>  <p><b>0186613</b> M=28x1,5 RHT</p>	<p><b>42037032</b> 42037033</p>	<p>L=1535</p>	<p>80-16 AW 120-13/16/17 ANW</p>

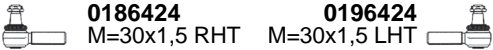
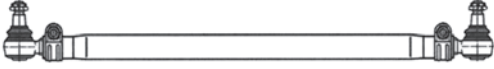
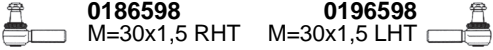
## BARRE ACCOPPIAMENTO - TIE RODS



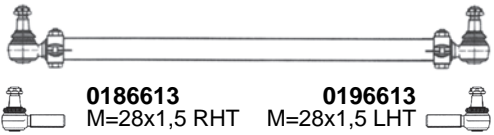
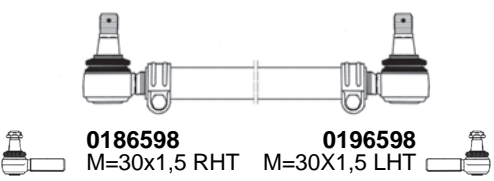
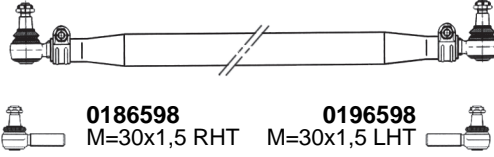

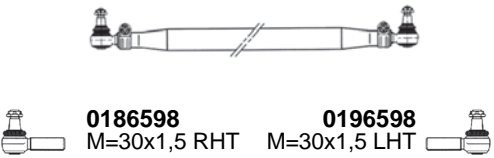
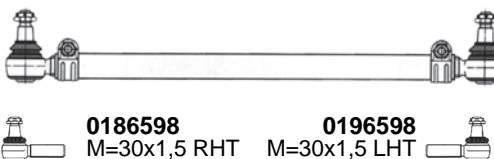







RIF. OCAP OCAP REF.	RIF. ORIG O.E. NUMBER	NOTE REMARKS	MODELLO / DESCRIZIONE MODEL / DESCRIPTION
<b>0506881</b>     <b>0186612</b> <b>0196612</b> M=24x1,5 RHT    M=24x1,5 LHT	<b>2443499</b>	L=1544	256 M 19 FK
<b>0506553</b>     <b>0186598</b> <b>0196598</b> M=30x1,5 RHT    M=30x1,5 LHT	<b>4835068</b>	L=1565	160.26-170NC35 170/190/F26/F35/F35H 180.24/.26-190.126/135 190.30/.38-190.33/.36/.42.48 220.36PT/.38PT 240.26/.30P/.36/.38P/.48 260.36/.38/.48
<b>0506953</b>     <b>0186424</b> <b>0196424</b> M=30x1,5 RHT    M=30x1,5 LHT	<b>4854871</b>	L=1584	EUROCARGO - EUROFIRE - EUROFIRE TECTOR MIDIRIDER - TECTOR - TECTOR RESTYLING
<b>0506994</b>     <b>0186598</b> <b>0196598</b> M=30x1,5 RHT    M=30x1,5 LHT	<b>98470968</b> 4844041	L=1590	EUROCARGO: 170E15/E18/E23/E27 260E27KE TECTOR: 180E21/E24/E28 EUROPOLIS: 200E.9.15-200E.10.2
<b>0506788</b>     <b>0186424</b> <b>0196424</b> M=30x1,5 RHT    M=30x1,5 LHT	<b>42026853</b> 2476050	L=1603	130-13 AH 130-16 AH 150-16 AN
<b>0506794</b>     <b>0186598</b> <b>0196598</b> M=30x1,5 RHT    M=30x1,5 LHT	<b>42037655</b> 2475843 42014656 42014657 42026837 42026840 42037657	L=1606	190-30 H 240-34 AH 260-25 AH - 260-25 AHB 330-30 H

**BARRE ACCOPPIAMENTO - TIE RODS**

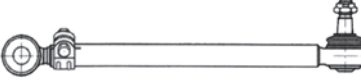











RIF. OCAP OCAP REF.	RIF. ORIG O.E. NUMBER	NOTE REMARKS	MODELLO / DESCRIZIONE MODEL / DESCRIPTION
<p><b>0506755</b></p>  <p><b>0186613</b> M=28x1,5 RHT    <b>0196613</b> M=28x1,5 LHT</p>	<p><b>42102058</b> 2476066</p>	<p>L=1630</p>	<p>160-23 AH 190-30 HT</p>
<p><b>0506817</b></p>  <p><b>0186598</b> M=30x1,5 RHT    <b>0196598</b> M=30x1,5 LHT</p>	<p><b>98458724</b> 98427667</p>	<p>L=1636</p>	<p>EUROTECH: 180E24/27/30 190E24/27/30 400E30/34</p>
<p><b>0506847</b></p>  <p><b>0186598</b> M=30x1,5 RHT    <b>0196598</b> M=30x1,5 LHT</p>	<p><b>42003432</b></p>	<p>L=1640</p>	<p>190-26H/26N 260-26H/26N/35H 330F26/F35 330-26H/26N/30H/35H TURBOSTAR - TURBOTECH</p>
<p><b>0506932</b></p>  <p><b>0186598</b> M=30x1,5 RHT    <b>0196598</b> M=30x1,5 LHT</p>	<p><b>41005450</b> 8163773 41005451 41036944 8138182</p>	<p>L=1641</p>	<p>EUROMOVER - EUROSTAR - EUROSTAR CURSOR EUROTECH - EUROTECH CURSOR EUROTRAKKER - EUROTRAKKER CURSOR STRALIS</p>
<p><b>0507860</b></p>  <p><b>0186598</b> M=30x1,5 RHT    <b>0196598</b> M=30x1,5 LHT</p>	<p><b>8137594</b></p>	<p>L=1385</p>	<p>EUROSTAR - EUROSTAR CURSOR STRALIS - EUROTECH - EUROTECH CURSOR</p>
<p><b>0507288</b></p>  <p><b>0186598</b> M=30x1,5 RHT    <b>0196598</b> M=30x1,5 LHT</p>	<p><b>8165309</b> 41005460 41005309</p>	<p>L=1560</p>	<p>EUROCARGO: 150 EUROTRAKKER: 190-260 340-410 E.TRAK CURSOR:190-340-380 410-720 E.TRAK: 380</p>















## TIRANTI LONGITUDINALI - DRAG LINKS

RIF. OCAP OCAP REF.	RIF. ORIG O.E. NUMBER	NOTE REMARKS	MODELLO / DESCRIZIONE MODEL / DESCRIPTION
<b>0506725</b>   <b>0186614</b> M=18x1,5 RHT	<b>8557536</b> 9009500	Lt=663	35 NC-40/45 NC 49 NC-OM 35-OM 40 OM 45-OM 50 U.T.
<b>0506887</b>   <b>0186424</b> M=30x1,5 RHT	<b>8590435</b>	Lt=665	95.14-95.14Z 109.14 2 serie 190.14Z UNIC - ZETA
<b>0506851</b>   <b>0186424</b> M=30x1,5 RHT	<b>2454629</b>	L=689	120-13ANW 120-17ANW 130-13AH/AN 150-16 ANW 160-17AN-ANW
<b>0506927</b>   <b>0186598</b> M=30x1,5 RHT	<b>41016964</b> 8136061 41005456 41005466	L=698	EUROTRAKKER: 340E34/37/42 410E37/E42
<b>0507164</b>   <b>0186424</b> M=30x1,5 RHT	<b>8573757</b>	Lt=702	100.13/F13 2 serie con servosterzo e cabina ribaltabile (with power steering and tilting cab)
<b>0506812</b>   <b>0186424</b> M=30x1,5 RHT	<b>8570528</b>	L=708	con s/sterzo e cab.ribalt. (with power steering and tilting cab) ZETA: 50.9Z-65.9-79.14 TURBO ZETA: 60.11-65.12/H-79.12 60F10-60.10 79F10-79F13-79.10-79.13-79.14 90.13/F13



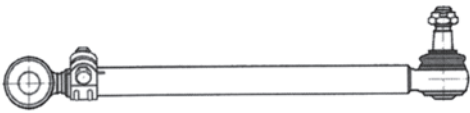



**TIRANTI LONGITUDINALI - DRAG LINKS**

RIF. OCAP OCAP REF.	RIF. ORIG O.E. NUMBER	NOTE REMARKS	MODELLO / DESCRIZIONE MODEL / DESCRIPTION
<b>0507306</b>   <b>0186598</b> M=30x1,5 RHT	<b>42043295</b> 42043909 42043910	L=744	190.25 AN/ANT/ANW 190.30 N 260.25 AN 330.30 AN/ANW/N/NW MAGIRUS
<b>0506736</b>   <b>0186608</b> M=28x1,5 RHT	<b>8567618</b> 8582350 8567619	L=755	con s/sterzo e cabina fissa (with power steering and fixed cab) 50.8-50.10/F10 60.10/F10-65.10/F10 65.9Z-79.10-79.13-79.14 90.13/F13 ZETA
<b>0506858</b>   <b>0186598</b> M=30x1,5 RHT	<b>2519077</b>	L=764	190.26NT
<b>0506737</b>   <b>0186612</b> M=24x1,5 RHT	<b>8591219</b> 8564248	L=766	con s/sterzo e cab.ribalt. (with power steering and tilting cab) 60.10/F10-75.10/F10 79.10/F10-79.13/F13 90.13/F13 senza s/sterzo e cab. ribalt. (without powersteering and tilting cab) 50.9Z-60.11 5.12-79.12 T.ZETA
<b>0506728</b>   <b>0186613</b> M=28X1,5 RHT	<b>8558540</b> 8558541	Lt=778	65/70/75/80/90NC OM65/70/75/80/90 (*): (giuda DX- RH drive 75NC-OM75)
<b>0507859</b>   <b>0186424</b> M=30x1,5 RHT	<b>500324282</b>	L=785	TECTOR: 120E17/E21 EUROCARGO: 120EL15/EL18/EL21

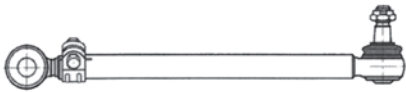









## TIRANTI LONGITUDINALI - DRAG LINKS

RIF. OCAP OCAP REF.	RIF. ORIG O.E. NUMBER	NOTE REMARKS	MODELLO / DESCRIZIONE MODEL / DESCRIPTION
<b>0506856</b>   <b>0186598</b> M=30x1,5 RHT	<b>42043293</b> 42043908	L=796	160.23ANW 170.23AHW 190.25AN/ANT MAGIRUS
<b>0506854</b>   <b>0186598</b> M=30x1,5 RHT	<b>2461519</b>	L=810	190.19ANW 190.26NT
<b>0506814</b>   <b>0186424</b> M=30X1,5 RHT	<b>2458534</b>	L=816	256M26K
<b>0506951</b>   <b>0186424</b> M=30x1,5 RHT	<b>98402544</b> 98467459	L=822	EUROCARGO: 60E10/E12/E14 - 65E10/E12/E14 75E10/E12/E14/E15 80E15/E18/E21 - 100E15/E18/E21 120E15/18/23 - 130E15/18/23 150E18/E23/E27 - 180E21 260E23 - 280E23 -320E27
<b>0507287</b>   <b>0186598</b> M=30x1,5 RHT	<b>41016961</b> 8135492 41005469 41011476 41016960	L=824	EUROSTAR: 400 EUROSTAR CURSOR: 400 EUROTECH: 400 E34/38/42 E.TECH CURSOR: 440 STRALIS: 440 S40/43/48/54
<b>0506726</b>   <b>0186612</b> M=24x1,5 RHT	<b>8591222</b> 8558522 8559559	L=830	50/55 NC-50.8/F8 50.9/F9-50.10/F10 50.9Z-55.8/F8-55.9/F9 55.10/F10 60.8/F8-60.10/F10 60.11 TURBO ZETA-65.10/F10 70.10/F10-75.10-79.10 79.13/14-80.13-90.12 83.10/F13-90.13/F13 OM 50-OM 55





TIRANTI LONGITUDINALI - DRAG LINKS

RIF. OCAP OCAP REF.	RIF. ORIG O.E. NUMBER	NOTE REMARKS	MODELLO / DESCRIZIONE MODEL / DESCRIPTION
<p><b>0506897</b></p>  <p><b>0186598</b> M=30x1,5 RHT</p>	<p><b>41016958</b> 8135446 41005472</p>	<p>L=832</p>	<p>EUROSTAR: 400E38/42/47 E.STAR CURSOR: 440E39/43 EUROTECH: 400E34/38 STRALIS: 440s40/43/44/48/54</p>
<p><b>0506860</b></p>  <p><b>0186598</b> M=30x1,5 RHT</p>	<p><b>2444423</b></p>	<p>L=852</p>	<p>220-32AHT</p>
<p><b>0507347</b></p>  <p><b>0186424</b> M=30x1,5 RHT</p>	<p><b>42023779</b> 42023778</p>	<p>L=872</p>	<p>120-17</p>
<p><b>0506928</b></p>  <p><b>0186613</b> M=28x1,5 RHT</p>	<p><b>42211148</b> 42211146 42200700 42204475</p>	<p>L=874</p>	<p>80-13A2/A3/AW 80 16A4 80-13ABP 90-13A</p>
<p><b>0507321</b></p>  <p><b>0186613</b> M=28x1,5 RHT</p>	<p><b>80003410</b></p>	<p>L=874</p>	<p>75-9A</p>
<p><b>0506956</b></p>  <p><b>0186598</b> M=30x1,5 RHT</p>	<p><b>98469650</b> 98449025</p>	<p>L=878</p>	<p>EUROCARGO: 170E15/E18/E23 TECTOR: 180E21/E24/E28 260E23/27/28KE TECTOR RESTYLING</p>







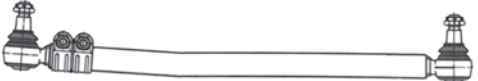





## TIRANTI LONGITUDINALI - DRAG LINKS

RIF. OCAP OCAP REF.	RIF. ORIG O.E. NUMBER	NOTE REMARKS	MODELLO / DESCRIZIONE MODEL / DESCRIPTION
<b>0507367</b>   <b>0187364</b> M=30x1,5 RHT	<b>500336085</b> 500308895 99455009	L=883 T=52	
<b>0507851</b> 	<b>98493054</b>	L=887	EUROCARGO: 150E15/E18/E21
<b>0507904</b>   <b>0186598</b> M=30x1,5 RHT	<b>41028269</b> 41298449	L=887	EUROTRAKKER MP 340 - MP 410 - 1993 > 11/2004
<b>0506855</b>   <b>0186598</b> M=30x1,5 RHT	<b>42001326</b> 42001325 42086458	L=890	160-23AH/AHW - 160-30AHW 170-23 AH/AHB - 190-26H/HW 200-32AHW 260-30AH/AHT/AHW 300-25AHB-330.26/F26 330-30/30H 2^serie 330-35/F35 - 330.36 - 260-34AH (rinforzato-stiffened) MAGIRUS
<b>0507301</b>   <b>0186424</b> M=30x1,5 RHT	<b>42035419</b> 42035418	L=895	75-13 AWM
<b>0506952</b>   <b>0186424</b> M=30x1,5 RHT	<b>4854874</b>	L=897	EUROCARGO: 120E15/E18/E23 130E15/E18/E23 140E15/E18/E23 150E18/E23/E27R 260E23T-280E23T 320E27T EUROFIRE



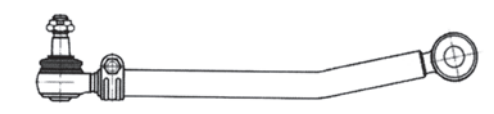

TIRANTI LONGITUDINALI - DRAG LINKS

RIF. OCAP OCAP REF.	RIF. ORIG O.E. NUMBER	NOTE REMARKS	MODELLO / DESCRIZIONE MODEL / DESCRIPTION
<p><b>0507368</b></p>  <p><b>0186598</b> M=30x1,5 RHT</p>	<p><b>504049893</b></p>	<p>L=897 T=42</p>	<p>EUROCARGO: 120-130-140-150-160</p>
<p><b>0506893</b></p>  <p><b>0186595</b> M=24x1,5 RHT</p>	<p><b>80003408</b> 42204473 80003406</p>	<p>L=898</p>	<p>75-9AH 80-9A - 80-9AH 70M6FL 90M6FL/FK</p>
<p><b>0506894</b></p>  <p><b>0186598</b> M=30x1,5 RHT</p>	<p><b>98446354</b></p>	<p>L=901</p>	<p>EUROTECH: 180E24/27/30/34 190E24/27/30 325E27 400E30/34</p>
<p><b>0506828</b></p>  <p><b>0186424</b> M=30x1,5 RHT    <b>0186424</b> M=30x1,5 RHT</p>	<p><b>42202358</b> 42203459</p>	<p>L=904</p>	<p>110-13A/16A 130M11FL 160M11FS/FK/FL</p>
<p><b>0506848</b></p>  <p><b>0186598</b> M=30x1,5 RHT</p>	<p><b>42042950</b> 42043912</p>	<p>L=910</p>	<p>190-26H/.30H 260-26H/30H/35H 330-26H/35H - 330-30H (1^ serie) 330-36 (1^ serie) (rinforzato-stiffened)</p>
<p><b>0506717</b></p>  <p><b>0186599</b> M=38x1,5 RHT</p>	<p><b>4699305</b></p>	<p>Lt=920</p>	<p>170NC26-170NC33 170NT26-170NT33 170NC35-170NT35 190NC26-190NC33 190NT26-190NT33 190NC35-190NT35 guida DX (RH drive)</p>

## TIRANTI LONGITUDINALI - DRAG LINKS





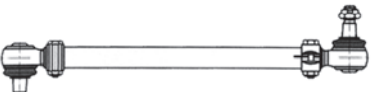







RIF. OCAP OCAP REF.	RIF. ORIG O.E. NUMBER	NOTE REMARKS	MODELLO / DESCRIZIONE MODEL / DESCRIPTION
<b>0506839</b>   <b>0186599</b> M=38x1,5 RHT	<b>4715615</b>	Lt=920	160-26/26T 170.20 - 170-26/F26/F26T - 170-35 190.20 - 190-26/F26/F26T 190-35 - 190-38 240-26 - 240-35 TURBOTECH
<b>0506745</b>   <b>0186424</b> M=30x1,5 RHT	<b>61595371</b>	Lt=930	150NC 17 150NC 20
<b>0506915</b>   <b>0186424</b> M=30x1,5 RHT	<b>4815933</b>	Lt=930	145.17 EUROSTAR EUROSTAR CURSOR
<b>0506741</b>   <b>0186424</b> M=30x1,5 RHT	<b>61590910</b>	Lt=935	150NC17/20
<b>0506743</b>   <b>0186599</b> M=38x1,5 RHT	<b>61593332</b>	Lt=937	159NC LHD 159NC 20
<b>0507293</b>   <b>0186598</b> M=30x1,5 RHT	<b>41005475</b> 41006093	L=952	EUROTRAKKER: 180-190-260 330-400-410 E. TRAK CURSOR: 180-190-380

**TIRANTI LONGITUDINALI - DRAG LINKS**







RIF. OCAP OCAP REF.	RIF. ORIG O.E. NUMBER	NOTE REMARKS	MODELLO / DESCRIZIONE MODEL / DESCRIPTION
<p><b>0506931</b></p>  <p><b>0186598</b> M=30x1,5 RHT</p>	<p><b>41005463</b> 8131582 8132397 41042919</p>	<p>L=953</p>	<p>EUROSTAR - EUROSTAR CURSOR EUROTECH - EUROTECH CURSOR EUOTRAKKER - EUROTRAKKER CURSOR STRALIS</p>
<p><b>0507365</b></p> 	<p><b>5801282537</b> 5801282538</p>	<p>L=953 T=50</p>	<p>EUROSTAR - EUROTECH - EUOTRAKKER - STRALIS - TRAKKER</p>
<p><b>0507370</b></p>  <p><b>0186598</b> M=30x1,5 RHT</p>	<p><b>41215165</b> 41226580</p>	<p>L=959 T=52</p>	<p>EUOTRAKKER - TRAKKER</p>
<p><b>0507369</b></p>  <p><b>0186598</b> M=30x1,5 RHT</p>	<p><b>500397738</b></p>	<p>L=959 T=36</p>	<p>EUROSTAR - EUROTECH - STRALIS</p>
<p><b>0507850</b></p>  <p><b>0186598</b> M=30x1,5 RHT</p>	<p><b>98473328</b></p>	<p>L=966</p>	<p>EUROCARGO: 95E15-95E21-135E18-135E23 EUROFIRE: 95E18-135E22-135E24-140E24-140E28 TECTOR: 100E18-100E21-150E18-150E24</p>
<p><b>0506810</b></p>  <p><b>0186599</b> M=38x1,5 RHT    <b>0196599</b> M=38x1,5 LHT</p>	<p><b>4704183</b></p>	<p>L=970</p>	<p>370S12/S24/S35 260R106/R119</p>











## TIRANTI LONGITUDINALI - DRAG LINKS

RIF. OCAP OCAP REF.	RIF. ORIG O.E. NUMBER	NOTE REMARKS	MODELLO / DESCRIZIONE MODEL / DESCRIPTION
<b>0507163</b>   <b>0187158</b> M=25x1,5 RHT	<b>6159597</b> 61591070	Lt=973	100NC-110PC OM110-OM110 OM110P guida SX (LH drive) cabina ribaltabile (tilting cab)
<b>0507310</b>   <b>0186598</b> M=30x1,5 RHT	<b>42087848</b> 42078019	L=974	TURBOTECH: 220-36 PT
<b>0507309</b>   <b>0186598</b> M=30x1,5 RHT	<b>42087846</b>	L=974	TURBOTECH: 220-36 PT
<b>0507161</b>   <b>0186599</b> M=38x1,5 RHT	<b>4722108</b>	Lt=975	220 F 38 TURBO
<b>0506826</b>   <b>0186599</b> M=38x1,5 RHT	<b>4793166</b> 4834041	Lt=975	165.24 175.17 175.24
<b>0506716</b>   <b>0186599</b> M=38x1,5 RHT	<b>4699246</b>	L=976	170NC26-170NC33 170NT26-170NT33 170NC35-170NT35 190NC26-190NC33 190NT26-190NT33 190NC35-190NT35









**TIRANTI LONGITUDINALI - DRAG LINKS**

RIF. OCAP OCAP REF.	RIF. ORIG O.E. NUMBER	NOTE REMARKS	MODELLO / DESCRIZIONE MODEL / DESCRIPTION
<p><b>0506820</b></p>  <p><b>0186608</b> M=28x1,5 RHT</p>	<p><b>4834037</b> 4773359</p>	<p>L=979</p>	<p>115-14 - 115-17 135-14 - 135-17 145-17 150 - 159-17</p>
<p><b>0506746</b></p> 	<p><b>61595960</b> 61590824</p>	<p>Lt=982</p>	<p>veicoli con cabina ribaltabile (vehicles with tilting cab) 130NC-NR-NT OM130/R/T</p>
<p><b>0506840</b></p>  <p><b>0186598</b> M=30x1,5 RHT</p>	<p><b>42087842</b> 4747690 4747961 42087841 4207841 4747960</p>	<p>L=982</p>	<p>190 - TURBOSTAR - TURBOTECH</p>
<p><b>0507303</b></p>  <p><b>0186598</b> M=30x1,5 RHT</p>	<p><b>42039631</b></p>	<p>L=993</p>	<p>280M26FS</p>
<p><b>0507853</b></p>  <p><b>0186424</b> M=30x1,5 RHT</p>	<p><b>500363545</b></p>	<p>L=1114</p>	<p>EUROCARGO TECTOR 120E118</p>
<p><b>0507852</b></p>  <p><b>0186424</b> M=30x1,5 RHT</p>	<p><b>500362533</b></p>	<p>L=1190</p>	<p>EUROCARGO TECTOR 130E24</p>



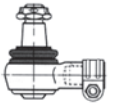



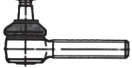

## TIRANTI LONGITUDINALI - DRAG LINKS

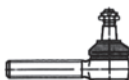
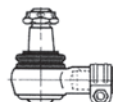
RIF. OCAP OCAP REF.	RIF. ORIG O.E. NUMBER	NOTE REMARKS	MODELLO / DESCRIZIONE MODEL / DESCRIPTION
<b>0507314</b>   <b>0187314</b> M=30x1,5 RHT	<b>42118694</b> 42115532	L=1485	EUROTRAKKER: 190E31 E.TRAKKER CURSOR: 180E24/27 190E231/35/38/44 260E35/38/44 380E35/38/44 410E44 720E44
<b>0507371</b> 	<b>8166702</b>	L=1540 T=48	EUROTRAKKER MP 340-410
<b>0507866</b>   <b>0186598</b> M=30x1,5 RHT <b>0196598</b> M=30x1,5 LHT 	<b>504034521</b>	L=1570	TECTOR: 180E21-180E24-180E28 260E28KE
<b>0507284</b> 	<b>42088124</b> 4720262	L=2421	TURBOTECH: 220-36 PT
<b>0506764</b>   <b>0186598</b> M=30x1,5 RHT	<b>4765442</b>	L=2460	470.20-471.20 U.EFFEUNO 570.20-571.20-670.20 260SH110-260SH170

**TESTE STERZO - TIE RODS END**

RIF. OCAP OCAP REF.	RIF. ORIG O.E. NUMBER	NOTE REMARKS	MODELLO / DESCRIZIONE MODEL / DESCRIPTION
<b>0287361</b> 	<b>42533073</b>	L=75  M=26x1,5 RHT	EUROSTAR - STRALIS
<b>0280513</b> 	<b>9750079980</b> 4336779	L=80  M=16x1,5 RHT	FIAT DUCATO TALENTO
<b>0280515</b> 	<b>93800662</b> 93804059 1903652	L=80  M=16x1,5 RHT	OM GRINTA FIAT 28.8-30.8 30.9-32.8/9/10 40.8-45.10-49.10
<b>0287906</b> 	<b>42533102</b> 1394446	L=80  M=26x1,5 RHT	EUROSTAR - EUROTECH - STRALIS
<b>0287313</b> 	<b>42105474</b> 42532294	L=85  M=26x1,5 RHT	EUROTRAKKER: 340E34/37/42 410E37/42 E. TRAKKER CURSOR: 340E35 410E35
<b>0287320</b> 	<b>42530316</b> 42538047 93157156	L=86  M=30x1,5 RHT	320-32AHB EUROTRAKKER: 340E34/37/42 410E37/42 E. TRAK CURSOR: 340E35 410E35
<b>0287360</b> 	<b>42533101</b>	L=90  M26x1,5	EUROSTAR - STRALIS
<b>0289923</b> 	<b>1271126</b> 42538048 82953016019 81953016268 82953016018 3099128 3090291	L=90  M=36x1,5	
<b>0186614</b> 	<b>4579231</b> 9009501	L=98  M=18x1,5 RHT	35 NC-40/45 NC OM 40 U.T. 625N1/N2/N3





## TESTE STERZO - TIE RODS END

RIF. OCAP OCAP REF.	RIF. ORIG O.E. NUMBER	NOTE REMARKS	MODELLO / DESCRIZIONE MODEL / DESCRIPTION
<b>0196614</b> 	<b>4579232</b> 9009503	L=98  M=18x1,5 LHT	35 NC-40/45 NC OM 40 U.T. 625N1/N2/N3
<b>0287291</b> 	<b>9281792</b>	L=95  M=24x1,5 RHT	
<b>0186595</b> 	<b>42491937</b> 42480024	L=95  M=24x1,5 RHT	70M6FL 75.9A - 80.9 90M6FL/FK
<b>0196595</b> 	<b>42480023</b> 8193649	L=95  M=24x1,5 LHT	70M6FL 75.9A - 80.9 90M6FL/FK
<b>0187158</b> 	<b>61595957</b> 61591070	L=105  M=25x1,5 RHT	100NC 110PC-OM110 OM110P cabina ribaltabile (tilting cab)
<b>0186613</b> 	<b>42484886</b> 4833825 8193645 8558533 8582322 2966321 2966635	L=105  M=28x1,5 RHT	50-60.8/9/10 - 65-79.10 GAMMA ZETA 80-90.13-79.12/13/14 - 80-90 NC-109.14 OM 65-OM 70-OM 75 ZETA - TURBOZETA
<b>0196613</b> 	<b>42484887</b> 4833826 8123394 8193646 8558536 2969507	L=105  M=28x1,5 LHT	50-60.8/9/10 - 65-79.10 GAMMA ZETA 80-90.13-79.12/13/14 - 80-90 NC-109.14 OM 65-OM 70-OM 75 ZETA - TURBOZETA
<b>0186612</b> 	<b>8558527</b> 42487165 93194626	L=105  M=24x1,5RHT	50 NC-55 NC OM 50-OM 55 ZETA TURBOZETA
<b>0196612</b> 	<b>8558524</b> 7984276 93194627	L=105  M=24x1,5LHT	50 NC-55 NC OM 50-OM 55 ZETA TURBOZETA



**TESTE STERZO - TIE RODS END**

RIF. OCAP OCAP REF.	RIF. ORIG O.E. NUMBER	NOTE REMARKS	MODELLO / DESCRIZIONE MODEL / DESCRIPTION
<b>0187278</b>  	<b>2981461</b>	L=115  M=28x1,5 RHT	
<b>0186608</b>  	<b>4688941</b> 8582332 7167757 8565366	L=115  M=28x1,5 RHT	50.8-60.10-65.10-65.9 ZETA-79.10-79.12 79.13-79.14-90.13-109.14-115.14 100.13-109.14-115.14 135.14-130NR20-140.14-145.17-150.14 TURBOZETA
<b>0196608</b>  	<b>4688942</b> 8582333	L=115  M=28x1,5 LHT	50.8-60.10-65.10-65.9 ZETA-79.10-79.12 79.13-79.14-90.13-109.14-115.14 100.13-109.14-115.14 135.14-130NR20-140.14-145.17-150.14 TURBOZETA
<b>0186424</b>  	<b>2966688</b> 2980323 3096213 42483520 42485718 42493781 4833820 4833827 8122754	L=115  M=30x1,5 RHT	ZETA - EUROCARGO - MK - PEGASO
<b>0196424</b>  	<b>2980129</b> 2984511 42493782 4833821 4833828 8122755	L=115  M=30x1,5 LH	ZETA - EUROCARGO - MK - PEGASO
<b>0281143</b>  	<b>1306716080</b>	L=118  M=16x1,5 RHT	FIAT DUCATO TALENTO
<b>0186598</b>  	<b>4833829</b> 42537936 42488269 42483386 4802443 2969808 42489594	L=120  M=30x1,5 RHT	EUROCARGO - EUROSTAR - EUROTECH - STRALIS
<b>0196598</b>  	<b>4833830</b> 42491957 4802444 2984061 8190225 42489395		EUROCARGO - EUROSTAR - EUROTECH - STRALIS

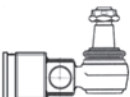
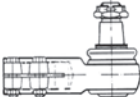
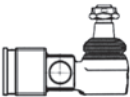
## TESTE STERZO - TIE RODS END



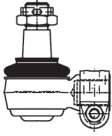

RIF. OCAP OCAP REF.	RIF. ORIG O.E. NUMBER	NOTE REMARKS	MODELLO / DESCRIZIONE MODEL / DESCRIPTION
0187146 	2980875	L=120  M=30x1,5 RHT	
0186599 	4688948	L=120  M=38x1,5 RHT	165.24-170.26-170.35-175.24 170.17-180.24 TURBOTECH - TURBOSTAR
0196599 	4688949	L=120  M=38x1,5 LHT	165.24-170.26-170.35-175.24 170.17-180.24 TURBOTECH - TURBOSTAR
0187364 	500309296	L=139  M=30x1,5 RHT	EUROSTAR LD - EUROTECH MH-MP - STRALIS AD-AS
0186656 	4688951	M=64x1,5 RHT  RHD	170NC26/NC33/NC35 170NT26/NT33/NT35 190NC26/NC 33/NC35 190NT26/NT33/NT35  Servosterzo (Power steering axle)
0186655 	4688952	M=64x1,5 RHT  LHD	170NC26/NC33/NC35 170NT26/NT33/NT35 190NC26/NC 33/NC35 190NT26/NT33/NT 35  Servosterzo (Power steering axle)
0287159 	4688946	M=30x1,5 RHT	60.10/.F10-60.11 T. ZETA 65.9/.12-65.10/.F10 T.ZETA 79.10/.F10/.12 T.ZETA 90.13/.F13 100.13/.F13-109.14 ZETA 115.14-115.17-135.14/.14H-135.17 e deriv. 145.17-150.14/.17 150.NC17/20/NR20/NT20  Servosterzo (Power steering axle)
0187160 	4688944	M=64x1,5 RHT	60.10/.F10 - 60.11 T. ZETA 65.9/.12-65.10/.F10 T.ZETA 79.10/.F10/.12 T.ZETA 90.13/.F13 100.13/.F13-109.14 ZETA 115.14 - 115.17-135.14/.14H 135.17 e deriv.-145.17 - 150.14/.17 150.NC17/NC20/NR20/NT20  Servosterzo (Power steering axle)

**TESTE STERZO - TIE RODS END**





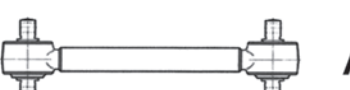
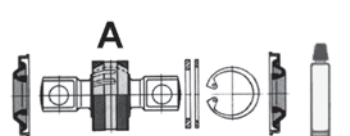
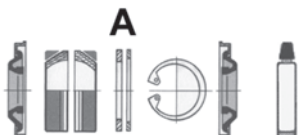

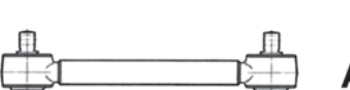
RIF. OCAP OCAP REF.	RIF. ORIG O.E. NUMBER	NOTE REMARKS	MODELLO / DESCRIZIONE MODEL / DESCRIPTION
<b>0288003</b>  	-	L=76  M=26x1,5 RH	Testa per servosterzo terzo asse (Tie rod end for power steering axle)
<b>0287238</b>  	<b>93192809</b>	L=91  M=30x1,5 RH	E. TRAKKER: 190E30/42 - 380E42 EUROSTAR: 240E38/42/47/52 EUROTECH: 240E25/30/38/42  Testa per servosterzo terzo asse (Tie rod end for power steering axle)





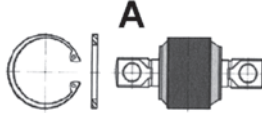

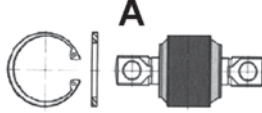
## BARRE DI REAZIONE - TORQUE RODS

RIF. OCAP OCAP REF.	RIF. ORIG O.E. NUMBER	NOTE REMARKS	MODELLO / DESCRIZIONE MODEL / DESCRIPTION
<b>0807363</b> 	<b>41218021</b>	L=582 T=60	TRAKKER AD - AT
<b>0907330</b> 	<b>93192619</b> 42493431	l=152 p=24 D=80 d=21	
<b>0807209</b> 	<b>42125057</b> 98488010 4714134	L=582  d=19	190.30-240.30 TURBOSTAR: 190.36/42/48 TURBOTECH: 190.32/36-220.32/36
<b>0907578</b> 	<b>93161371</b>	l=130  D=65 d=19	
<b>0907586</b> 	<b>0005861533</b> 093161371	D=65	senza perno (without pin)
<b>0807213</b> 	<b>98488010</b>	L=583  d=19	TURBOSTAR: 190.30/.36/.42/.48 240.30 TURBOTECH: 190
<b>0907259</b> 	<b>42488722</b> 2969844	l=130 p=30 D=70 d=19	
<b>0807207</b> 	<b>4714134</b>	L=583  d=19	175.24-190.30-240.30 EUROCLASS TURBOSTAR: 190.33/.36/.42/.48 TURBOTECH: 190.32/.32GV/.36/.36GV 220.32/.36/.38 -240.32/.32GV/.36



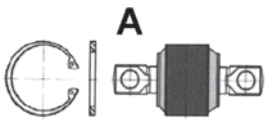

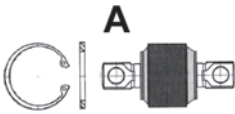
**BARRE DI REAZIONE - TORQUE RODS**

RIF. OCAP OCAP REF.	RIF. ORIG O.E. NUMBER	NOTE REMARKS	MODELLO / DESCRIZIONE MODEL / DESCRIPTION
<b>0907258</b> 	<b>2980884</b> 81432206132	l=130 p=30 D=65 d=19	
<b>0907757</b> 	-	D=65	SENZA PERNO (without pin)
<b>0807358</b> 	<b>41035951</b> 41009661 8137027 98472466	L=590  d=19	EUROCARGO - EUROMOVER - EUROSTAR EUROSTAR CURSOR - EUROTECH EUROTRAKKER CURSOR TECTOR - TECTOR RESTYLING STRALIS
<b>0907327</b> 	<b>93192361</b>	l=130 p=24 D=62 d=19	
<b>0807292</b> 	<b>500340452</b> 41003268	L=594  d=19,5	EUROMOVER: 260 EUROSTAR:240 400 E.STAR CURSOR:260 EUROTECH:2402 260 440 EURO TECH CNG:240 E.TECH CURSOR:260 STRALIS:260
<b>0907327</b> 	<b>93192361</b>	l=130 p=24 D=62 d=19	
<b>0807336</b> 	<b>98472871</b>	L=594  d=19	EUROTECH: 180E24/E27/E30/E34 190E24/E27/E30 400E30/E34

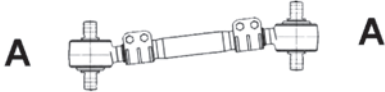
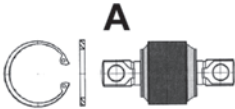

## BARRE DI REAZIONE - TORQUE RODS

RIF. OCAP OCAP REF.	RIF. ORIG O.E. NUMBER	NOTE REMARKS	MODELLO / DESCRIZIONE MODEL / DESCRIPTION
<b>0907327</b> 	<b>93192361</b>	l=130 p=24 D=62 d=19	
<b>0507192</b> 	<b>4626261</b> 4670853	L=610	FIAT: 300 PC- 697 N- 697 NP
<b>0807262</b> 	<b>42034054</b> 42000481	L=610  d=21	330.26 330.30 Turbo 330.35-330.36 TURBOTECH
<b>0907262</b> 	<b>2983125</b>	l=152 p=35 D=80 d=21	
<b>0807295</b> 	<b>42065332</b> 41011006	L=610  d=21	330.26H 330.30AN/H/N/NW 330.36H EUROTRAKKER: 330E34/E37 - 340E42 380/E31/E34/E37/E42 410E37/E42 720E31/E37/E42 E.TRAKKER CURSOR: 380E42/44 -720E42/E44 TRAKKER:AD/AT
<b>0907330</b> 	<b>93192619</b> 42493431	l=152 p=24 D=80 d=21	



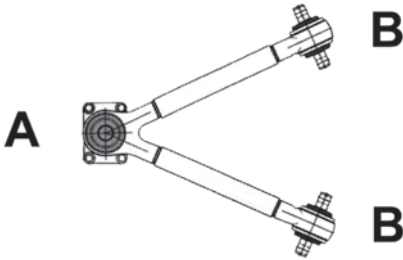
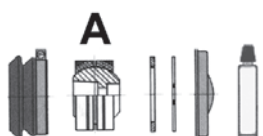

**BARRE DI REAZIONE - TORQUE RODS**

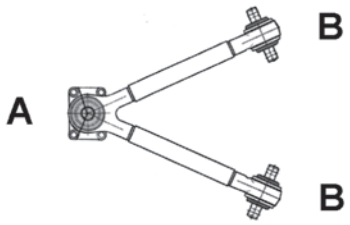
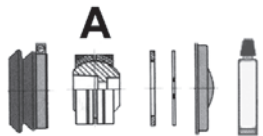
RIF. OCAP OCAP REF.	RIF. ORIG O.E. NUMBER	NOTE REMARKS	MODELLO / DESCRIZIONE MODEL / DESCRIPTION
<p><b>0807579</b></p> 	<b>42041107</b>	<p>L=610</p> <p>d=21</p>	<p>EUROCARGO - EUROSTAR EUROTECH - EUROTECH CURSOR EUROTRAKKER - EUROTRAKKER CURSOR STRALIS AD/AT</p>
<p><b>0907304</b></p> 	<b>93192618</b>	<p>l=152</p> <p>p=24</p> <p>D=70</p> <p>d=21</p>	
<p><b>0807298</b></p> 	<p><b>42034051</b> 42000486</p>	<p>L=630</p> <p>d=21</p>	<p>330 F26/.26H- 330F35/.35H 330F35T/.35HT- 330.30H/.30HT 330.36H</p>
<p><b>0907262</b></p> 	<b>2983125</b>	<p>l=152</p> <p>p=35</p> <p>D=80</p> <p>d=21</p>	
<p><b>0807326</b></p> 	<p><b>97104296</b> 93165049</p>	<p>L=640</p> <p>d=15</p>	<p>490 590E22 590E2</p>
<p><b>0807374</b></p> 	<p><b>41296730</b> 41296731</p>	<p>L=665</p> <p>T=48</p> <p>l=152</p> <p>d=25</p>	<p>STRALIS AD - AS</p>

## BARRE DI REAZIONE - TORQUE RODS

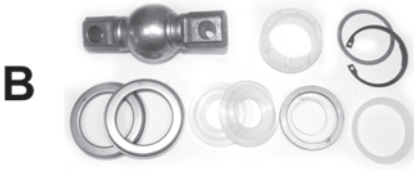
RIF. OCAP OCAP REF.	RIF. ORIG O.E. NUMBER	NOTE REMARKS	MODELLO / DESCRIZIONE MODEL / DESCRIPTION
0907774 	41272706 Z 0003502405 81432706110	L=152 p=24 D=80 d=25	
0807282 	4463926	L=647  d=19	TURBOTECH: 190-26T/32T/36 T 220-32/36 - 240-32/36 TURBOSTAR: 190-33P-190-33T/36T/42T/48T
0907257 	2968454	L=50 IK=38 D=65	
0907258 	2980884 81432206132	L=130 p=30 D=65 d=19	
0907757 	-	D=65	SENZA PERNO (without pin)
0807208 	4716271	L=647  d=19	190.30-190.38 220.38(1985)-240.30 TURBOSTAR: 190.36/42/48 TURBOTECH: 190.32/36 220.32/36 240.32/.36
0907257 	2968454	L=50 IK=38 D=65	

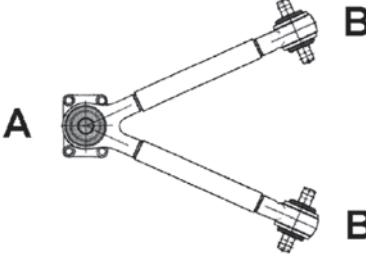
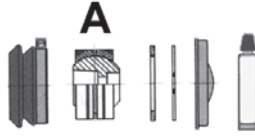
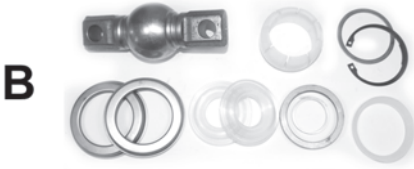

**BARRE DI REAZIONE - TORQUE RODS**

RIF. OCAP OCAP REF.	RIF. ORIG O.E. NUMBER	NOTE REMARKS	MODELLO / DESCRIZIONE MODEL / DESCRIPTION
<b>0907258</b> 	<b>2980884</b> 81432206132	l=130 p=30 D=65 d=19	
<b>0907757</b> 	-	D=65	SENZA PERNO (without pin)
<b>0807257</b> 	<b>4716799</b>	L=647 d=19	190.38 (1 Serie-Chassis) 220.38 (1983) -240.30 TURBOSTAR: 190-33 P-190-33 T 19 0-42 T TURBOTECH: 190-26 T-190-32 T 190-36 T-240.32-240.36
<b>0907257</b> 	<b>2968454</b>	L=50 IK=38 D=65	
<b>0907258</b> 	<b>2980884</b> 81432206132	l=130 p=30 D=65 d=19	
<b>0907757</b> 	-	D=65	SENZA PERNO (without pin)

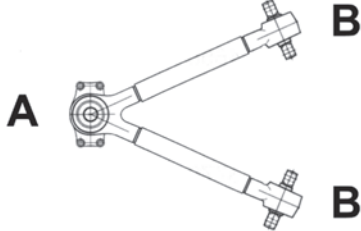
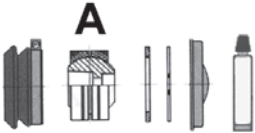
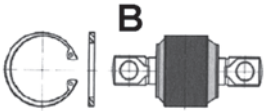
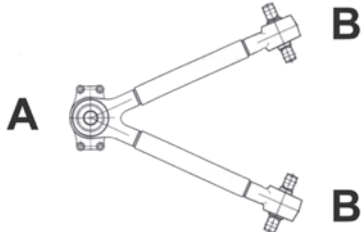
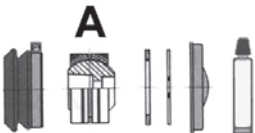
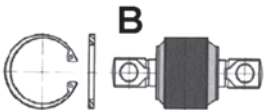
## BARRE DI REAZIONE - TORQUE RODS



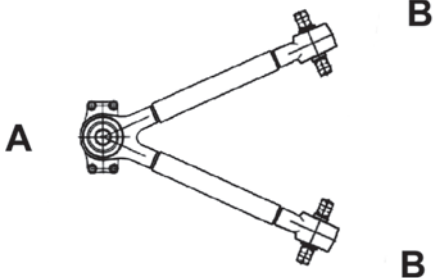
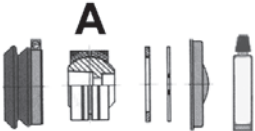
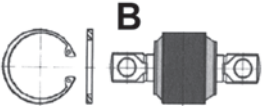

RIF. OCAP OCAP REF.	RIF. ORIG O.E. NUMBER	NOTE REMARKS	MODELLO / DESCRIZIONE MODEL / DESCRIPTION
<b>0807589</b>  	<b>98472468</b> 41042092 41028599	L=659  d=19	EUROCARGO: 120E15/E18/E23-130E15/18/E23 150E15/E18/E23/E27-170E18/E23/E27 260E23-280E23-320E27 EUROTECH: 180E24/E27/E30/E34-190E24/E27/E30 325E27 400E30/E34 EUROSTAR STRALIS
<b>0907297</b>  	<b>93161958</b> 93162239	D=65  IK=38	
<b>0907327</b>  	<b>93192361</b>	l=130 p=24 D=62 d=19	
<b>0807296</b>  	<b>41028599</b> 41042092 41022092 98472468	L=665  d=21	EUROCARGO: 120E15/E18/E23 130E15/18/E23/E24 150E15/E18/E23/E27 170E18/E23/E27 260E23-280E23-320E27 EUROTECH: 180E24/E27/E30/E34 190E24/E27/E30 325E27 400E24/E30 TECTOR: 130E28-150E18/E24 150E24-180E21/E24/E28 320E28T
<b>0907297</b>  	<b>93161958</b> 93162239	D=65  IK=38	
<b>0907327</b>  	<b>93192361</b>	l=130 p=24 D=62 d=19	

BARRE DI REAZIONE - TORQUE RODS



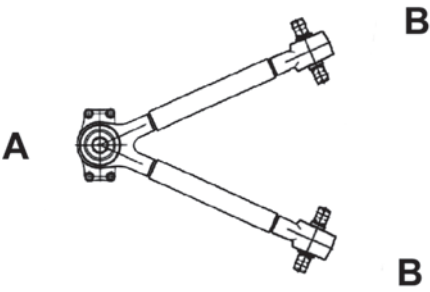
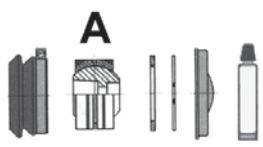
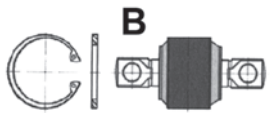

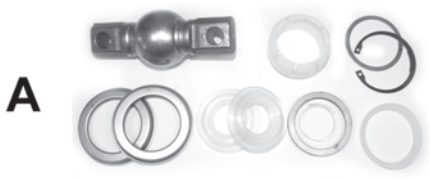
RIF. OCAP OCAP REF.	RIF. ORIG O.E. NUMBER	NOTE REMARKS	MODELLO / DESCRIZIONE MODEL / DESCRIPTION
<p><b>0807372</b></p> 	<b>41218621</b>	L=665 T=48 l=152/130 d=25/21	STRALIS AD - AS
<p><b>0807373</b></p>  <p><b>0907774</b></p> 	<p><b>41272706</b></p> <p><b>41272706 Z</b> 0003502405 81432706110</p>	L=665 T=48 l=152 d=25  l=152 p=24 D=80 d=25	STRALIS AD - AS
<p><b>0807211</b></p>  <p><b>0907297</b></p>  <p><b>0907296</b></p> 	<p><b>41042050</b> 41028598 41002770 8137026 41009665 41028600 41029665 41033479 41035950 41034479 225.027 (4)</p> <p><b>93161958</b> 93162239</p> <p><b>93161960</b> 93162361</p>	L=665  d=21  D=65  IK=38  l=130 p=24 D=62 d=21	<p>EUROCARGO EUROMOVER:190E24-260E24 EUROSTAR:180E38/E42 190E38/E42/E47/52 240E38/E42/E47/E52 400E38/E42/E47E52 440E38/E42/E47 E.STAR CURSOR:190E39/E43 440E39 EUROTECH:180E34/E38 400E34/E38 - CNG E.TRAK CURSOR:260E31/E35 340E38/E35 STRALIS:260S40/S43 - AD - AT TECTOR</p>

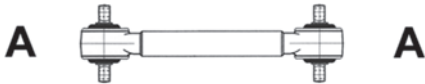

BARRE DI REAZIONE - TORQUE RODS

RIF. OCAP OCAP REF.	RIF. ORIG O.E. NUMBER	NOTE REMARKS	MODELLO / DESCRIZIONE MODEL / DESCRIPTION
<p><b>0807299</b></p> 	<p><b>41042093</b> 500340451</p>	<p>L=665</p> <p>d=21</p>	<p>E. STAR CURSOR: 190/E39/E43 E. TECH CURSOR: 190/E31/E35/E43 STRALIS: 190S40/S43/S48 260E40/E43/E54 EURTRAKKER CURSOR</p>
<p><b>0907299</b></p> 	<p><b>93161631</b> 93161638</p>	<p>L=46</p> <p>IK=38</p> <p>D=65</p>	
<p><b>0907296</b></p> 	<p><b>93161960</b> 93162361</p>	<p>l=130</p> <p>p=24</p> <p>D=62</p> <p>d=21</p>	
<p><b>0807308</b></p> 	<p><b>42086282</b></p>	<p>L=665</p> <p>d= 19</p>	<p>TURBOTECH: 220-32/36 TURBOSTAR</p>
<p><b>0907258</b></p> 	<p><b>2980884</b> 81432206132</p>	<p>l=130</p> <p>p=30</p> <p>D=65</p> <p>d=19</p>	
<p><b>0907757</b></p> 	-	D=65	SENZA PERNO (without pin)

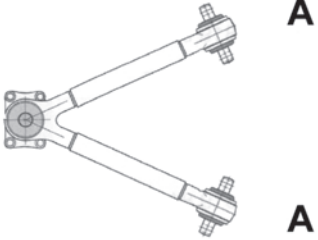

**BARRE DI REAZIONE - TORQUE RODS**

RIF. OCAP OCAP REF.	RIF. ORIG O.E. NUMBER	NOTE REMARKS	MODELLO / DESCRIZIONE MODEL / DESCRIPTION
<p><b>0807283</b></p>  <p><b>0907258</b></p>  <p><b>0907757</b></p> 	<p><b>4719609</b></p> <p><b>2980884</b> 81432206132</p> <p>-</p>	<p>L=677</p> <p>d=19</p> <p>I=130 p=30 D=65 d=19</p> <p>D=65</p>	<p>TURBOTECH: 220.38</p>  <p>SENZA PERNO (without pin)</p>
<p><b>0807286</b></p>  <p><b>0907258</b></p>  <p><b>0907757</b></p> 	<p><b>4855237</b></p> <p><b>2980884</b> 81432206132</p> <p>-</p>	<p>L=678</p> <p>d=19</p> <p>I=130 p=30 D=65 d=19</p> <p>D=65</p>	<p>175.24</p>  <p>SENZA PERNO (without pin)</p>

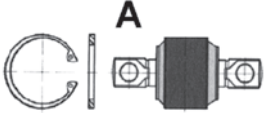



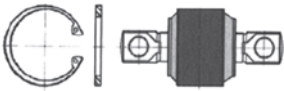
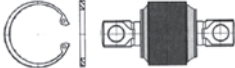
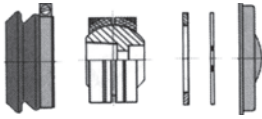

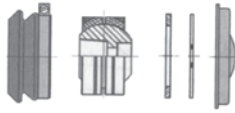
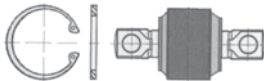
## BARRE DI REAZIONE - TORQUE RODS

RIF. OCAP OCAP REF.	RIF. ORIG O.E. NUMBER	NOTE REMARKS	MODELLO / DESCRIZIONE MODEL / DESCRIPTION
<b>0807328</b> 	<b>97104299</b>	L=803  d=19	490 490.12.22 490.18.29 500E2/E22
<b>0907327</b> 	<b>93192361</b>	l=130 p=24 D=62 d=19	

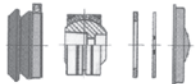
**KIT DI SOSPENSIONE - SUSPENSION KITS**

RIF. OCAP OCAP REF.	RIF. ORIG O.E. NUMBER	NOTE REMARKS	MODELLO / DESCRIZIONE MODEL / DESCRIPTION
<b>0907757</b> 	-	D=65	TURBOTECH - SENZA PERNO (without pin)
<b>0907327</b> 	<b>93192361</b>	l=130 p=24 D=62 d=19	EUROCARGO
<b>0907262</b> 	<b>2983125</b>	l=152 p=35 D=80 d=21	
<b>0907257</b> 	<b>2968454</b>	L=50 IK=38 D=65	TURBOSTAR - TURBOTECH
<b>0907258</b> 	<b>2980884</b> 81432206132	l=130 p=30 D=65 d=19	TURBOSTAR - TURBOTECH
<b>0907774</b> 	<b>41272706 Z</b> 0003502405 81432706110	l=152 p=24 D=80 d=25	STRALIS AD - AS
<b>0907297</b> 	<b>93161958</b> 93162239	D=65  IK=38	EUROCARGO
<b>0907296</b> 	<b>93161960</b> 93162361	l=130 p=24 D=62 d=21	EUROCARGO

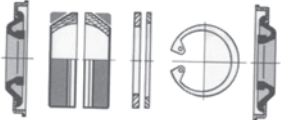
## KIT DI SOSPENSIONE - SUSPENSION KITS

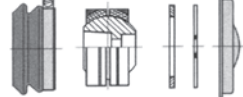
RIF. OCAP OCAP REF.	RIF. ORIG O.E. NUMBER	NOTE REMARKS	MODELLO / DESCRIZIONE MODEL / DESCRIPTION
0907407 	500333284	l=130  D=74,9 d=19	EUROSTAR - EUROTECH MP - STRALIS
0907299 	93161631 93161638	L=46  IK=38 D=65	E. STAR CURSOR: 190/E39/E43 E. TECH CURSOR: 190/E31/E35/E43 STRALIS: 190S40/S43/S48 260E40/E43/E54 EURTRAKKER CURSOR
0907927 	93163617 093163617	p=24 D=67 d=19	EUROCARGO
0907330 	93192619 42493431	l=152 p=24 D=80 d=21	EUROTRAKKE MP - TRAKKER AD
0907304 	93192618	l=152 p=24 D=70 d=21	EUROCARGO - EUROSTAR EUROTECH - EUROTECH CURSOR EUROTRAKKER - EUROTRAKKER CU RSOR STRALIS AD/AT
0907586 	0005861533 093161371	D=65	190.30-240.30 TURBOSTAR: 190.36/42/48 TURBOTECH: 190.32/36-220.32/36
0907259 	42488722 2969844	l=130 p=30 D=70 d=19	TURBOSTAR: 190.30/.36/.42/.48 - 240.30 TURBOTECH: 190
0907487 	2968454	IK=38  D=65	TURBOSTAR - TURBOTECH

**SNODI SOSPENSIONI - SUSPENSION JOINTS**

RIF. OCAP OCAP REF.	RIF. ORIG O.E. NUMBER	NOTE REMARKS	MODELLO / DESCRIZIONE MODEL / DESCRIPTION
<b>0280517</b> 	<b>93802209</b> 93804060 500310933	L=72  M=20x1,5 RHT	OM GRINTA FIAT 28.8-30.8/.9 32.8/.9/.10 40.8-45.10 49.10
<b>0187157</b> 	<b>2460515</b>	L=95	330.26/.30/.35H 330.30/.35HT
<b>0400097</b> 	<b>4388159</b>	m=14x1,5	FIAT DUCATO TALENTO
<b>0400096</b> 	<b>7567284</b>	m=16x1,5	FIAT DUCATO TALENTO
<b>0401137</b> 	<b>1302368080</b>	m=16x1,5	FIAT DUCATO TALENTO
<b>0401138</b> 	<b>1300473080</b>	m=18x1,5	FIAT DUCATO TALENTO
<b>0401451</b> 	<b>1331641080</b>	m=16x1,5	FIAT DUCATO MOD. 1.8 t - CH. 6087206 >
<b>0401446</b> 	<b>1331640080</b> 364055 3640.55	m=18x1,5	FIAT DUCATO MOD. 1.0 - 1.4 t. - CH. 6086766 >

## SNODI SOSPENSIONI - SUSPENSION JOINTS

RIF. OCAP OCAP REF.	RIF. ORIG O.E. NUMBER	NOTE REMARKS	MODELLO / DESCRIZIONE MODEL / DESCRIPTION
0400518 	93807545 93802242	m=18x1,5	OM GRINTA FIAT 28.8-30.8/.9 32.8/.9/.10-40.8 45.10-49.10
0187156 	2463583	M=20x1,5	330.35
0407249 	500379801 500334713 500344888 500379802 500334714 500344887		MOD: 35S9/10/11/12/13/15 35C9/10/11/12/13/15 - 29L10/12 (I RIF. ORIGINALI CORRISPONDONO AL BRACCIO COMPLETO) (O.E. NUMBER REFERS TO THE COMPLETE CONTROL ARM)
0407250 	500334716 500334717		MOD: 35S9/10/11/12/13/15 35C9/10/11/12/13/15 - 29L10/12 (I RIF. ORIGINALI CORRISPONDONO AL BRACCIO COMPLETO) (O.E. NUMBER REFERS TO THE COMPLETE CONTROL ARM)

**STABILIZZATORI - STABILIZERS**

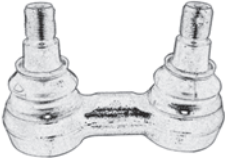
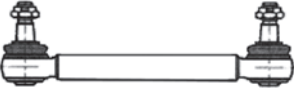
RIF. OCAP OCAP REF.	RIF. ORIG O.E. NUMBER	NOTE REMARKS	MODELLO / DESCRIZIONE MODEL / DESCRIPTION
<b>0507335</b>  	<b>98484091</b> 98488013	L=100	490.18.29E2 CITYCLASS: 25-29-35 491.22/.24/.27 591.22/.27
<b>0507165</b>  	<b>4741171</b>	L=355	175.24 TURBOSTAR: 130.30/33/36/42/48 190.36/42/48 TURBOTECH: 190.32/36-220.32/36-240.36/48



## TESTE COMANDO CAMBIO - GEAR BOX CONTROL BALL JOINTS

RIF. OCAP OCAP REF.	RIF. ORIG O.E. NUMBER	NOTE REMARKS	MODELLO / DESCRIZIONE MODEL / DESCRIPTION
0287294 	42071290	L=35  M=10x1	EUROCARGO - TECTOR - EUROTRAKKER EUROTRAKKER CURSER - EUROSTAR EUROTECH - EUROMOVER
0287319 	42485639	L=55  M=10	175.24 EUROCLASS:.29/.35/.HD EURORIDER:.29/.35/.38 TURBOSTAR:190.36/42/48 250.36/48-260.36/48 TURBOTECH:190.30-220.36 240.36/48-260.36
0287229 	8198187	L=55  M=12x1,75 RH	175.24-175.24 RSU 370.24/.30/.35 EUROCARGO:95E21-135E23 EUROCLASS-EURORIDER TURBOSTAR:190.24/.42/.48 240.36/.48-260.48 TURBOTECH:190.26-260.36
0297229 	8198188 42485638	L=55  M=12x1,75 LH	175.24-175.24 RSU 370.24/.30/.35 EUROCARGO:95E21-135E23 EUROCLASS-EURORIDER TURBOSTAR:190.24/.42/.48 240.36/.48-260.48 TURBOTECH:190.26-260.36
0281786 	42041327 41002118 42079853 41203863	L=55  M=10x1,5 RH	190 - 260 - 300 - 320 - 330 EUROCARGO - EUROFIRE EUROSTAR - E.TECH CURSOR EUROTRAKKER - TURBOTECH STRALIS
0291786 	42041328 41002119 42079850 42079852 41203864	L=55  M=10x1,5 LH	190 - 260 - 300 - 320 - 330 EUROCARGO - EUROFIRE EUROSTAR - E.TECH CURSOR EUROTRAKKER - TURBOTECH STRALIS
0186949 	41005523	L=75  M=16x1,5 RH	EUROTRAKKER EUROTECH: 190E34/38
0187228 	8550139	L=85  M=14 x 1,5 RH	50-75 115.15/17 135.14/17

**TESTE COMANDO CAMBIO - GEAR BOX CONTROL BALL JOINTS**

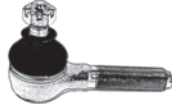
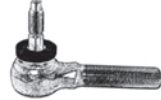
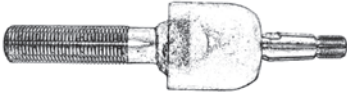
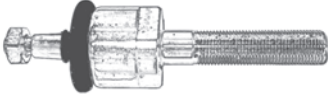
RIF. OCAP OCAP REF.	RIF. ORIG O.E. NUMBER	NOTE REMARKS	MODELLO / DESCRIZIONE MODEL / DESCRIPTION
<b>0187226</b> 	<b>8578493</b> 8582313	L=85  M=14 x 1,5 RH	50.9-60.11- 65.9/.12 79.12-79.14 Posteriore - Rear
<b>0181785</b> 	<b>42042912</b> 3435788 41218482	L=90  M=16x1,5 RH	EUROCARGO - EUROFIRE EUROTECH - EUROTECH CURSOR EUROTRAKKER - EUROTRAKKER CURSOR EUROSTAR - EUROSTAR CURSOR 19026H >330 - 30 AN TECTOR RESTYLING -TURBOTECH
<b>0187234</b> 	<b>8578492</b>	L=90  M=16 x 1,5 RH	50.9-60.11-65.9/.12 79.12-79.14 anteriore-front
<b>0607254</b> 	<b>42072495</b>	L=90  M=16 x 1,5 RH	190-26H > 330-36H EHRENREICH
<b>0607191</b> 	<b>41210795</b>	L=100  M=16 x 1,5 RH	E. TRAKKER CURSOR: 190E35 > 410E35 EUROSTAR CURSOR: 260E43 EUROTECH CURSOR: 4 40E39 > 440E43

## KIT PERNO FUSO - KING PIN SET

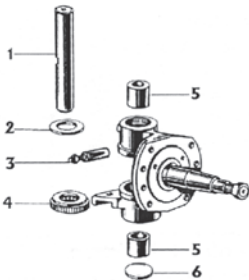
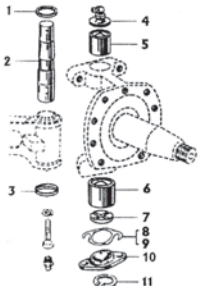
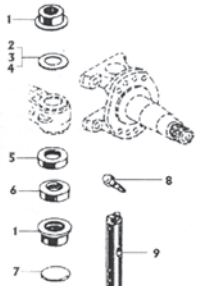
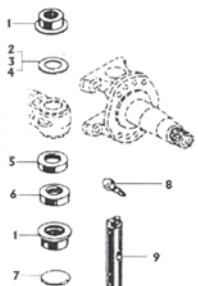
RIF. OCAP OCAP REF.	RIF. ORIG O.E. NUMBER	NOTE REMARKS	MODELLO / DESCRIZIONE MODEL / DESCRIPTION
<p><b>0927364</b></p> 	<p>8555441 (1) 8548473 (2) 540695 (3) 8557555 (4) 8555442 (5) 8563087 (6)</p>	<p>L=187</p> <p>D=28,8</p>	<p>(KIT COMPLETO PER Nr. 2 RUOTE) (KIT SUITABLE FOR Nr. 2 WHEELS)</p> <p>50-60-65-70-75 NC OM 50-55-65-70-75</p>
<p><b>0927365</b></p> 	<p>7163000 (1) 7162998 (2) 7162882 (3) 7164257 (4) 7162624 (5) 7162462 (6) 4676168 (7) 7173083 (8) 7173081 (9) 4676170 (10) 11059375 (11)</p>	<p>L=173</p> <p>D=27/34</p>	<p>(KIT COMPLETO PER Nr. 2 RUOTE) (KIT SUITABLE FOR Nr. 2 WHEELS)</p> <p>50/55.8/F8.9/F9.10/F10 60.8/F8 - 60/65/70.10/F10 75/79.10/F10 - 79/80/90.13/F13 60.11 TURBO Z 50/65.9Z - 65.12 TURBO Z</p>
<p><b>0927378</b></p> 	<p>608911 (1) 608898 (2) 608901 (3) 608903 (4) 608917 (5) 608916 (6) 10160801 (7) 4520406 (8) 4722939 (9)</p>	<p>L=220</p> <p>D=40</p>	<p>(KIT COMPLETO PER Nr. 2 RUOTE) (KIT SUITABLE FOR Nr. 2 WHEELS)</p> <p>682-690-691-180</p>
<p><b>0927379</b></p> 	<p>608911 (1) 608898 (2) 608901 (3) 608903 (4) 608917 (5) 608916 (6) 10160801 (7) 4520406 (8) 4722943 (9)</p>	<p>L=220</p> <p>D=40,1</p>	<p>(KIT COMPLETO PER Nr. 2 RUOTE) (KIT SUITABLE FOR Nr. 2 WHEELS)</p> <p>682-690-691-180</p>

**KIT PERNO FUSO - KING PIN SET**

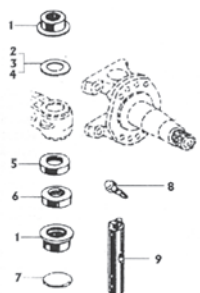
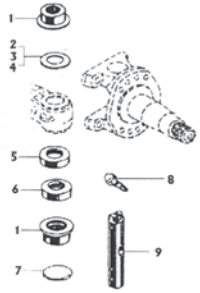
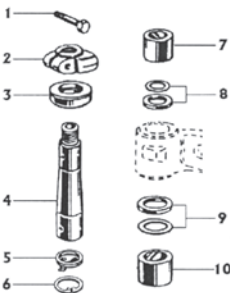
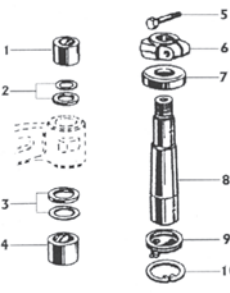
RIF. OCAP OCAP REF.	RIF. ORIG O.E. NUMBER	NOTE REMARKS	MODELLO / DESCRIZIONE MODEL / DESCRIPTION
<b>0927380</b>  	608911 (1) 608898 (2) 608901 (3) 608903 (4) 608917 (5) 608916 (6) 10160801 (7) 4520406 (8) 4722944 (9)	L=220  D=40,3	(KIT COMPLETO PER Nr. 2 RUOTE) (KIT SUITABLE FOR Nr. 2 WHEELS)  682-690-691-180
<b>0927381</b>  	608911 (1) 608898 (2) 608901 (3) 608903 (4) 608917 (5) 608916 (6) 10160801 (7) 4520406 (8) 4722945 (9)	L=220  D=40,5	(KIT COMPLETO PER Nr. 2 RUOTE) (KIT SUITABLE FOR Nr. 2 WHEELS)  682-690-691-180
<b>0927382</b>  	15540921 (1) 4540023 (2) 4578656 (3) 4597296 (4) 7164263 (5) 11060976 (6) 4608394 (7) 4596822 (8) 4596824 (9) 4608393 (10)	L=262  D=41/49,6	(KIT COMPLETO PER Nr. 2 RUOTE) (KIT SUITABLE FOR Nr. 2 WHEELS)  160NC - 619N - 683N 684N/NP - 693 N1
<b>0927383</b>  	7160200 (1) 4596822 (2) 4596824 (3) 4608393 (4) 15540921 (5) 4540023 (6) 4613620 (7) 4596193 (8) 7164263 (9) 11060976 (10)	L=266,5  D=41,2/50,8	(KIT COMPLETO PER Nr. 2 RUOTE) (KIT SUITABLE FOR Nr. 2 WHEELS)  693N1 U.T. 619N1/N1P 697N/NP 300PC/PT



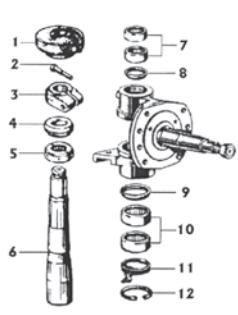
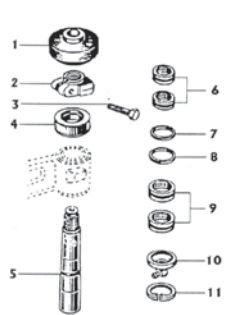
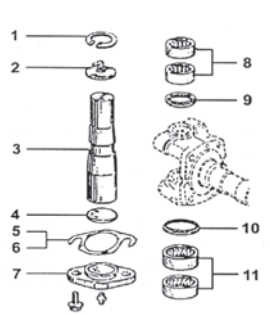
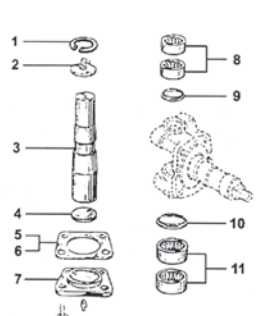

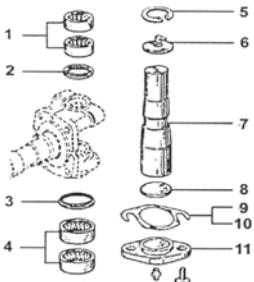

## KIT PERNO FUSO - KING PIN SET

RIF. OCAP OCAP REF.	RIF. ORIG O.E. NUMBER	NOTE REMARKS	MODELLO / DESCRIZIONE MODEL / DESCRIPTION
<b>0927387</b>  	4691212 (1) 15540921 (2) 4540023 (3) 7162586 (4) 4691211 (5) 7161882 (6) 7161012 (7) 7162447 (8) 7162448 (9) 716013 (10) 7164263 (11) 11060976 (12)	L=277,5  D=41,2/50,8	(KIT COMPLETO PER Nr. 2 RUOTE) (KIT SUITABLE FOR Nr. 2 WHEELS)  180.24/.24T/.26 190i26/i26T/i35/i35T 190.30/.30P/.30T/.30PT/.38/.38P/.38T/.38PT 190.33/.36/.42/.48 TURBOSTAR 220.38T/.38PT - 220F35T - 220.36PT 240.30/.30P - 240.38/.38P - 240.36P 159/175.17 - 165/175.24R/.24T
<b>0927388</b>  	4691212 (1) 4540023 (2) 15540921 (3) 7162586 (4) 7161882 (5) 7161012 (6) 7162447 (7) 7162448 (8) 716013 (9) 7164263 (10) 11060976 (11)	L=277,5  D=41,2/50,8	(KIT COMPLETO PER Nr. 2 RUOTE) (KIT SUITABLE FOR Nr. 2 WHEELS)  330.26H/.26HT/.26N 330.30H/.30HT 330.35H/.35HT
<b>0927391</b>  	11060076 (1) 7173052 (2) 7173087 (3) 7173077 (4) 7173083 (5) 7173081 (6) 7173086 (7) 7173061 (8) 40101041 (9) 40101051 (10) 7172870 (11)	L=178  D=28/35	(KIT COMPLETO PER Nr. 2 RUOTE) (KIT SUITABLE FOR Nr. 2 WHEELS)  EUROCARGO: 60/65E10/E12/E14 75E12/E14/E15 95E18 80/100E15/E18/E21 180E21
<b>0927392</b>  	16873476 (1) 7172857 (2) 7172939 (3) 7172939 (4) 7173021 (5) 7173309 (6) 7172938 (7) 7172874 (8) 40101061 (9) 40101031 (10) 7172971 (11)	L=227  D=43/53	(KIT COMPLETO PER Nr. 2 RUOTE) (KIT SUITABLE FOR Nr. 2 WHEELS)  EUROCARGO: 150E15H/E18H 170E15/E18/E23/E27 260E23KE/E27KE EUROTECH EUROSTAR EUROTRAKKER





**KIT PERNO FUSO - KING PIN SET**

RIF. OCAP OCAP REF.	RIF. ORIG O.E. NUMBER	NOTE REMARKS	MODELLO / DESCRIZIONE MODEL / DESCRIPTION
<p><b>0927393</b></p> 	<p>7172870 (1) 40101051 (2) 40401061 (3) 7172874 (4) 16873476 (5) 7172857 (6) 7172846 (7) 7172860 (8) 7172852 (9) 7172854 (10) 7172847 (11)</p>	<p>L=199</p> <p>D=35/43</p>	<p>(KIT COMPLETO PER Nr. 2 RUOTE) (KIT SUITABLE FOR Nr. 2 WHEELS)</p> <p>EUROCARGO: 120/130E15/E18/E23 150E15/E18/E23/E27 260E23 - 280E23 - 320E27</p>

**BARRE ACCOPPIAMENTO - TIE RODS**





RIF. OCAP OCAP REF.	RIF. ORIG O.E. NUMBER	NOTE REMARKS	MODELLO / DESCRIZIONE MODEL / DESCRIPTION
<p><b>0507819</b></p>  <p><b>0186424</b> M=30x1,5 RHT</p>	<p><b>81467106435</b> 81467106434</p>	<p>L=904</p>	<p>M 90</p>
<p><b>0507845</b></p>  <p><b>0186424</b> M=30x1,5 RHT</p>	<p><b>81467106438</b> 81467106439</p>	<p>L=1000</p>	<p>M 90: 17.192-17.232-17.272-18.192 18.222-18.232-18.262-18.272</p>
<p><b>0507846</b></p>  <p><b>0186598</b> M=30x1,5 RHT</p>	<p><b>81467106442</b> 81467106443 81467106460</p>	<p>L=1005</p>	<p>M 90: 17.192-17.232-17.272-18.192 18.222-18.232-18.262-18.272 24.192-24.222-24.232-24.262 24.272</p>
<p><b>0507816</b></p>  <p><b>0186613</b> M=28x1,5 RHT    <b>0196613</b> M=28x1,5 LHT</p>	<p><b>81467106409</b> 81467106238 81467106410 81467106240 81467106242 81467106411</p>	<p>L=1430</p>	<p>G 90 L 2000</p>
<p><b>0507405</b></p>  <p><b>0186424</b> M=30x1,5 RHT</p>	<p><b>81467106926</b> 81467116743 81467116744 81467116810 81467116884 81467116885</p>	<p>L=1450 T=50</p>	<p>L 2000-M 2000 L-M 2000 M-M 90-TGM</p>
<p><b>0507832</b></p>  <p><b>0186613</b> M=28x1,5 RHT</p>	<p><b>81467106325</b> 81467106086 81467107001</p>	<p>L=1525</p>	<p>520 H</p>

**BARRE ACCOPPIAMENTO - TIE RODS**

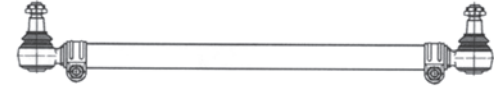

RIF. OCAP OCAP REF.	RIF. ORIG O.E. NUMBER	NOTE REMARKS	MODELLO / DESCRIZIONE MODEL / DESCRIPTION
<p><b>0507848</b></p>  <p><b>0186598</b> M=30x1,5 RHT    <b>0196598</b> M=30x1,5 LHT</p>	<p><b>81466106579</b> 81466106580 81466106583 81466106624 81466106640 81467116720</p>	<p>L=1530</p>	<p>F 90-F 2000 M 2000 - TGA TGS - TGX</p>
<p><b>0507534</b></p>  <p><b>0186424</b> M=30x1,5 RHT    <b>0196424</b> M=30x1,5 LHT</p>	<p><b>81467106316</b> 81467106314 81467106315</p>	<p>L=1545 T=38</p>	<p>M 90 - M 2000 L</p>
<p><b>0507833</b></p>  <p><b>0186599</b> M=38x1,5 RHT</p>	<p><b>81467106937</b> 81467106118 81467106162 81467106164 81467106189 81467106368 81467106369 81467106394 81467106833 82467106016</p>	<p>L=1585</p>	<p>F 90: 35.302-35.322</p>
<p><b>0507847</b></p>  <p><b>0186424</b> M=30x1,5 RHT    <b>0196424</b> M=30x1,5 LHT</p>	<p><b>81467106393</b> 81467106388 81467106390 81467106189 81467106164 81467106394 81467106369 81467106368 814671406367 81467106118</p>	<p>L=1585</p>	<p>M 90: 17.192-17.232-17.272-18.192 18.222-18.232-18.262-18.272 24.192-24.222-24.232-24.262 24.272</p>
<p><b>0507817</b></p>  <p><b>0186598</b> M=30x1,5 RHT</p>	<p><b>81467106912</b> 81467106122 81467106194 81467106195 81467106836 81467106378 81467106379 81467106380 81467106830</p>	<p>L=1588</p>	<p>F 7-F 8 F 90-F 2000 M 90- M 2000 TGA - TGM - TGS</p>

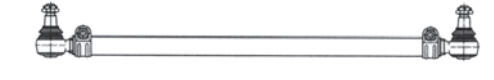



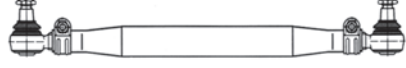

**BARRE ACCOPPIAMENTO - TIE RODS**

RIF. OCAP OCAP REF.	RIF. ORIG O.E. NUMBER	NOTE REMARKS	MODELLO / DESCRIZIONE MODEL / DESCRIPTION
<p><b>0507840</b></p>  <p><b>0186613</b> M=28x1,5 RHT    <b>0196613</b> M=28x1,5 LHT</p>	<p><b>81467106852</b> 81467106851 81467106395 81467116719</p>	L=1620	L 2000-M 2000
<p><b>0507808</b></p>  <p><b>0186598</b> M=30x1,5 RHT</p>	<p><b>81467106904</b> 81467106816 81467106359 81467106360 81467106362 81467106265 81467106396 81467106397 81467106266 81467116724 81467106131</p>	L=1628	F 90 UNTERFLUR F 2000 - M 2000 - E 2000 M 90 - UL
<p><b>0507814</b></p>  <p><b>0186613</b> M=28x1,5 RHT    <b>0196613</b> M=28x1,5 LHT</p>	<p><b>81467116803</b> 81467116893 81467116894 81467116896</p>	L=1632 T=36	L 2000 - M 2000 - TGL - TGM
<p><b>0507841</b></p>  <p><b>0186595</b> M=24x1,5 RHT    <b>0196595</b> M=24x1,5 LHT</p>	<p><b>81467106866</b> 81467106865 81467116717 81467116728</p>	L=1645	L 2000: 8.103-8.113-8.153-8.163 8.223-8.224-9.153-9.163 9.223-9.224 TGA
<p><b>0507843</b></p>  <p><b>0187843</b> M=30x1,5</p>	<p><b>81467116711</b> 81467106934 81467106933</p>	L=1650	M 2000: 14.163-14.224-14.264-14.284 15.163-15.224-15.264-25.284



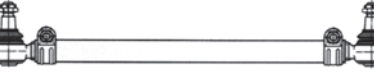



**BARRE ACCOPPIAMENTO - TIE RODS**

RIF. OCAP OCAP REF.	RIF. ORIG O.E. NUMBER	NOTE REMARKS	MODELLO / DESCRIZIONE MODEL / DESCRIPTION
<p><b>0507807</b></p>  <p><b>0186598</b> M=30x1,5 RHT    <b>0196598</b> M=30x1,5 LHT</p>	<p><b>81467106353</b>              81467106112              81467106354              81467106165              81467106163              81467106167              81467106198              81467106361              81467116725              81467106849              81467116820              81767106879</p>	<p>L=1652</p>	<p>F7/F8 - F 90 - F 2000              M 90 - M 2000              TGA - UNTERFLUR              TGS - TGX</p>
<p><b>0507581</b></p>  <p><b>0186598</b> M=30x1,5 RHT</p>	<p><b>81467116726</b>              81467106994</p>	<p>L=1664              T=50</p>	<p>E 2000 - F 2000</p>
<p><b>0507915</b></p>  <p><b>0187894</b> M=30x1,5 RHT</p>	<p><b>81467116773</b>              81467116858              81467116859              81467116860              81467116861              81467116863              81467116883              81467116921              81467116862              81467116920              81467116848              81467116888              81467116930              81467116882</p>	<p>L=1679</p>	<p>TGA - TGX</p>
<p><b>0507835</b></p>  <p><b>0186598</b> M=30x1,5 RHT    <b>0196598</b> M=30x1,5 LHT</p>	<p><b>81467106355</b>              81467106356              81467106373              81467106236              81467106267              81467106268              81467116723</p>	<p>L=1692</p>	<p>22.190</p>







**TIRANTI LONGITUDINALI - DRAG LINKS**

RIF. OCAP OCAP REF.	RIF. ORIG O.E. NUMBER	NOTE REMARKS	MODELLO / DESCRIZIONE MODEL / DESCRIPTION
<p><b>0507958</b></p>  <p><b>0186598</b> M=30x1,5 RHT    <b>0196598</b> M=30x1,5 LHT</p>	<p><b>81466106159</b> 81466106200 81466106275 81466106317 81466116064 81467106319 81467106280 81467106313</p>	<p>L=710 T=40</p>	<p>F 2000 - F 90</p>
<p><b>0507823</b></p>  <p><b>0186598</b> M=30x1,5 RHT    <b>0196598</b> M=30x1,5 LHT</p>	<p><b>81466106798</b> 81466106578 81466106598 81466106876</p>	<p>L=755</p>	<p>F 90 - F 2000</p>
<p><b>0507818</b></p>  <p><b>0186613</b> M=28x1,5 RHT</p>	<p><b>81466106305</b> 81466106301 81466106328</p>	<p>L=785</p>	<p>G 90</p>
<p><b>0506436</b></p>  <p><b>0186595</b> M=24X1,5 RHT</p>	<p><b>81466106304</b> 81466106327 81466106329 81466106281 81466106300 81466106303</p>	<p>L=785 T=30</p>	<p>G 90</p>
<p><b>0507217</b></p>  <p><b>0186424</b> M=30x1,5 RHT</p>	<p><b>85461106141</b> 85466106105 85466106141 85466106205 85466106231 85466106005</p>	<p>L=795 T=38</p>	<p>M 2000 L - TGL</p>
<p><b>0506445</b></p>  <p><b>0186598</b> M=30X1,5 RHT</p>	<p><b>81466106288</b> 81466106088</p>	<p>L=800</p>	<p>423-532</p>

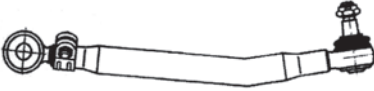



**TIRANTI LONGITUDINALI - DRAG LINKS**

RIF. OCAP OCAP REF.	RIF. ORIG O.E. NUMBER	NOTE REMARKS	MODELLO / DESCRIZIONE MODEL / DESCRIPTION
<p><b>0507844</b></p>  <p><b>0186598</b> M=30x1,5 RHT</p>	<b>81466106167</b>	L=805	16.28HA-16321HA (4x4) 1928HA-1932HA (4x4)
<p><b>0506444</b></p>  <p><b>0186598</b> M=30x1,5 RHT</p>	<b>81466106280</b>	L=815	16.280-19.240-19.280 20.281-22.280-26.280 32.280
<p><b>0507839</b></p>  <p><b>0186613</b> M=28x1,5 RHT</p>	<p><b>81466106754</b> 81466106753 85466106104 81466106006 81466106004 85466106031 85466106230</p>	L=825	L 2000: 8.103-8.113-8.153 8.163-8.223-8.224 9.183-9.163-9.223 9.224
<p><b>0506446</b></p>  <p><b>0186595</b> M=24x1,5 RHT</p>	<p><b>81466106725</b> 85466106201 85466106030 81466106001 81466106724 85466106102</p>	L=826	L 2000
<p><b>0507842</b></p>  <p><b>0186424</b> M=30x1,5 RHT</p>	<p><b>85466106012</b> 85466106142 85466106212 85466106112</p>	L=840	M 2000: 14.163-14.224-14.264-14.284 15.163-15.224-15.264-25.284
<p><b>0507533</b></p>  <p><b>0186613</b> M=28x1,5 RHT</p>	<p><b>85466106140</b> 85466106021 85466106121</p>	L=840 T=38	L 200 - M 2000 L - TGL





**TIRANTI LONGITUDINALI - DRAG LINKS**

RIF. OCAP OCAP REF.	RIF. ORIG O.E. NUMBER	NOTE REMARKS	MODELLO / DESCRIZIONE MODEL / DESCRIPTION
<p><b>0507821</b></p>  <p><b>0186598</b> M=30x1,5 RHT</p>	<b>81466106160</b>	L=848	33.320 (6x4)
<p><b>0507813</b></p>  <p><b>0186613</b> M=28x1,5 RHT</p>	<b>85466106247</b>	L=853 T=38	TGL 8T
<p><b>0507559</b></p>  <p><b>0186598</b> M=30x1,5 RHT</p>	<b>85466106143</b> 85466106107 85466106007	L=860 T=42	M 2000 L
<p><b>0507812</b></p>  <p><b>0186613</b> M=28x1,5 RHT</p>	<b>85466106246</b> 85466106160	L=864 T=38	TGL
<p><b>0507537</b></p>  <p><b>0186598</b> M=30x1,5 RHT</p>	<b>85466106144</b> 85466106108 85466106208	L=896 T=38	M 2000 L
<p><b>0507215</b></p>  <p><b>0186424</b> M=30x1,5 RHT</p>	<b>85466106019</b> 85466106119 85466106150 85466106219	L=910 T=40	M 2000 M





**TIRANTI LONGITUDINALI - DRAG LINKS**

RIF. OCAP OCAP REF.	RIF. ORIG O.E. NUMBER	NOTE REMARKS	MODELLO / DESCRIZIONE MODEL / DESCRIPTION
<p><b>0507214</b></p>  <p><b>0186424</b> M=30x1,5 RHT</p>	<p><b>81466106241</b> 81466106414</p>	<p>L=940 T=40</p>	<p>14.170/192</p>
<p><b>0507216</b></p>  <p><b>0186424</b> M=30x1,5 RHT</p>	<p><b>81467106436</b> 81467106437 81467106455</p>	<p>L=955 T=40</p>	<p>M 90</p>
<p><b>0507815</b></p>  <p><b>0186424</b> M=30x1,5 RHT</p>	<p><b>81466106692</b> 81466106693 81466106695 85466106020 85466106151</p>	<p>L=960 T=42</p>	<p>M 2000 M - M 90</p>
<p><b>0507408</b></p>  <p><b>0186598</b> M=30x1,5 RHT</p>	<p><b>81466106809</b> 81466106810 81466106823 81466106838 81466106839 81466116104 81466116105 81466116107 81466116134 81466116135 81466116137 81466116199 81466116200 81466116206</p>	<p>L=967 T=52</p>	<p>TGA-TGS-TGX</p>
<p><b>0507956</b></p>  <p><b>0186598</b> M=30x1,5 RHT</p>	<p><b>85466106018</b> 85466106118 85466106152 85466106218 85466106235</p>	<p>L=980 T=42</p>	<p>M 2000 M</p>

TIRANTI LONGITUDINALI - DRAG LINKS







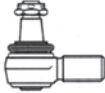

RIF. OCAP OCAP REF.	RIF. ORIG O.E. NUMBER	NOTE REMARKS	MODELLO / DESCRIZIONE MODEL / DESCRIPTION
<p><b>0507917</b></p>  <p><b>0186758</b> M30x1,5 RHT</p>	<p><b>81466106836</b> 81466116133 81466116197 81466116198 81466116132 81466116097 81466116096 81466106808 81466106807 81466116099 81466116136 81466116205</p>	L=993	TGA - TGS - TGX
<p><b>0507953</b></p>  <p><b>0186598</b> M30x1,5 RHT</p>	<p><b>85466106153</b> 85466106126 85466106226 85466106026</p>	L=1000 T=42	M 2000 M
<p><b>0507951</b></p>  <p><b>0186598</b> M30x1,5 RHT      <b>0186758</b> M30x1,5 RHT</p>	<p><b>81466106840</b> 81466116201 81466116202 81466116138 81466116139 81998051662 81466116145 81466116203 81466106811 81466106812</p>	L=1021 T=52	TGA - TGS
<p><b>0506443</b></p>  <p><b>0186442</b> M=30x1,5 RHT</p>	<p><b>81466106721</b> 81466106333 81466106334 81466106354 81466106355 81466106360 81466106361 81466106722 81466106723</p>	L=1040	F 7/8 - F 90 - UNTERFLUR - F2000
<p><b>0507955</b></p>  <p><b>0186598</b> M30x1,5 RHT      <b>0196598</b> M30x1,5 LHT</p>	<p><b>81466106374</b> 81466116019 82466106080 82466106189 82466106190</p>	L=1050 T=42	E 2000 - F 2000

**TIRANTI LONGITUDINALI - DRAG LINKS**





RIF. OCAP OCAP REF.	RIF. ORIG O.E. NUMBER	NOTE REMARKS	MODELLO / DESCRIZIONE MODEL / DESCRIPTION
<p><b>0507822</b></p>  <p><b>0186442</b> M=30x1,5 RHT</p>	<p><b>81466106779</b> 81466106780 81466106782</p>	<p>L=1060</p>	<p>F 2000</p>
<p><b>0507409</b></p>  <p><b>0186598</b> M=30x1,5 RHT</p>	<p><b>81466116004</b> 81466116003 81466116005</p>	<p>L=1063 T=42</p>	<p>F 2000 - E 2000</p>
<p><b>0507406</b></p>  <p><b>0186598</b> M=30x1,5 RHT</p>	<p><b>81466116006</b> 81466106669 81466106659 81466106656</p>	<p>L=1070 T=48</p>	<p>F 2000 - F 90</p>
<p><b>0507810</b></p>  <p><b>0186598</b> M=30x1,5 RHT</p>	<p><b>81466106603</b></p>	<p>L=1735 T=50</p>	<p>F 90</p>
<p><b>0507820</b></p> 	<p><b>81466106790</b> 81466106791 8246610691 82466106191</p>	<p>L=1749</p>	<p>F 2000</p>









**TESTE STERZO - TIE RODS END**

RIF. OCAP OCAP REF.	RIF. ORIG O.E. NUMBER	NOTE REMARKS	MODELLO / DESCRIZIONE MODEL / DESCRIPTION
0187838 	81953016096	L=75  M=26x1,5 RHT	
0287361 	81953016280 82953010010	L=75  M=26x1,5 RHT	F 2000 - TGA
0287906 	42533102 81953016219 81953016225 81953016226 81953016267 81953016291	L=80  M=26x1,5 RHT	F 90 - F 2000 - E 2000
0287360 	82953016016 81953016337 81953016281	L=90  M=26x1,5 RHT	F 2000
0289923 	1271126 42538048 82953016019 81953016268 82953016018 3099128 3090291	L=90 M=36x1,5 RHT	E 2000 - TGA - TGS - TGX
0186595 	81953016142 81953016134 81953016303 81953010077	L=95  M=24X1,5 RHT	G 90: 6.100-8.100 L 2000: 8.103-8.113-8.153-8.163 8.223-8.224-9.153-9.163 9.223-9.224 TGL - TGA
0196595 	81953016141 81953016304 81953010078	L=95  M=24X1,5 LHT	G 90: 6.100-8.100 L 2000: 8.103-8.113-8.153-8.163 8.223-8.224-9.153-9.163 9.223-9.224 TGL
0287684 	81953016106 81953016095 81953016071	L=95  M=26x1,5 RHT	15T GL - 27 T - 30T
0186613 	81953016060 81953016135 81953016140 81953016249	L=105  M=28x1,5 RHT	G 90 - L 2000 - M 2000 - TGL - TGM



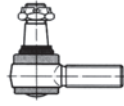

**TESTE STERZO - TIE RODS END**

RIF. OCAP OCAP REF.	RIF. ORIG O.E. NUMBER	NOTE REMARKS	MODELLO / DESCRIZIONE MODEL / DESCRIPTION
<b>0196613</b> 	<b>81953010079</b> 81953016139 81953016222	L=105  M=28x1,5 LHT	G 90 - L 2000 - M 2000 - TGL - TGM
<b>0186424</b> 	<b>81953016239</b> 81953016250 81953010064 81953016162 81953010014 81953010067 81953016067 90804153111 81953016246	L=115  M=30x1,5 RHT	F7-F8 - F 90 - F 2000 G 90 - M 90 - TGM - TGL L 2000-M 2000-F 2000
<b>0196424</b> 	<b>81953010074</b> 81953010013 81953016163 81953016068 90804153107 90804153113 81953010082	L=115  M=30x1,5 LHT	F7-F8 - F 90 - F 2000 G 90 - M 90 - TGM - TGL
<b>0186598</b> 	<b>81953016234</b> 81953016278 81953016242 81953016108 81953016112 81953010016 81953016048 81953016049 81953016053 81953016126 81953016090 81953016143 81953016149 81953016154 81953016156 81953016194 81953016274 81953016178 81953016224 81953010084	L=120  M=30x1,5 RH	F90-M90-L90 F2000-M2000-L2000 TGA-TGS-TGX F8-F9







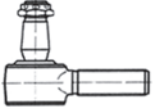
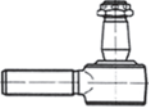

**TESTE STERZO - TIE RODS END**

RIF. OCAP OCAP REF.	RIF. ORIG O.E. NUMBER	NOTE REMARKS	MODELLO / DESCRIZIONE MODEL / DESCRIPTION
<b>0196598</b> 	<b>81953016237</b> 81953016279 81953010015 81953010087 81953016030 81953016043 81953016050 81953016054 81953016087 81953016125 81953016091 81953016107 81953016120 81953016152 81953016155 81953016157 81953016168 81953016179 81953016275 81953016223	L=120  M=30x1,5 LH	F90-M90-L90 F2000-M2000-L2000 TGA-TGS-TGX F8-F9
<b>0187146</b> 	<b>90804154117</b> 81953010025	L=120  M=30x1,5 RHT	F 7-F 8
<b>0197146</b> 	<b>81953016261</b> 81953016070	L=120  M=30x1,5 LHT	
<b>0186599</b> 	<b>81953016184</b> 81953016276	L=120  M=38x1,5 RHT	F 90: 35.302-35.322
<b>0187463</b> 	<b>81953010091</b>	L=135  M= 38x1,5 RHT	
<b>0186758</b> 	<b>81953010022</b> 0696226 0609643 0586714 0609634 0607073 1337367	L=135  M=30x1,5 RHT	F 90 - F 2000 - UNTERFLUR

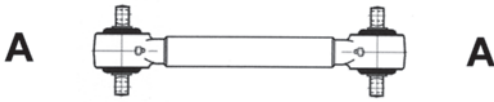





**TESTE STERZO - TIE RODS END**

RIF. OCAP OCAP REF.	RIF. ORIG O.E. NUMBER	NOTE REMARKS	MODELLO / DESCRIZIONE MODEL / DESCRIPTION
<b>0187843</b> 	<b>81953016270</b>	L=141  M=30x1,5 RHT	M 2000: 14.163-14.224-14.264-14.284 15.163-15.224-15.264 TGM
<b>0187894</b> 	<b>81953016271</b> 81953016325	L=145  M=30x1,5 RHT	TGA - TGX
<b>0187723</b> 	<b>81.95301.6288</b> 81953016288	L=150  M=30x1,5 RHT	M 2000 - TGA - TGS - TGX
<b>0186442</b> 	<b>81953016263</b>	L=155  M=30x1,5 RH	F 90 - F 2000 - M 90 - UNTERFLUR
<b>0187349</b> 	<b>81953016092</b>	L=160  M=38x1,5 RHT	
<b>0197523</b> 	<b>81953016093</b>	L=160  M=38x1,5 LHT	

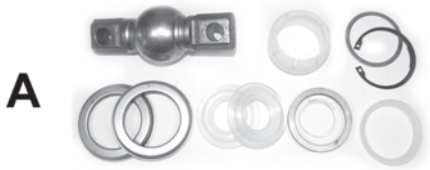



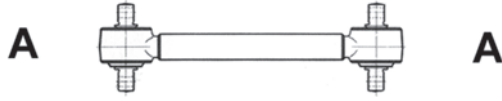

**BARRE DI REAZIONE - TORQUE RODS**

RIF. OCAP OCAP REF.	RIF. ORIG O.E. NUMBER	NOTE REMARKS	MODELLO / DESCRIZIONE MODEL / DESCRIPTION
<p><b>0807820</b></p>  <p><b>0907820</b></p> 	<p><b>81432206247</b> 81432206341 81432206342</p> <p><b>81432206322</b></p>	<p>L=414 T=50 l=130 d=23</p> <p>l=130 p=30 D=72 d=23</p>	TGA - TGS - TGX
<p><b>0807216</b></p>  <p><b>0907216</b></p> 	<p><b>81432306037</b> 81432309037</p> <p><b>81432306043</b></p>	<p>L=500 d=19</p> <p>l=130 p=30 D=65 d=19</p>	F7 - F8 - F 90 - F 2000
<p><b>0807821</b></p>  <p><b>0907259</b></p> 	<p><b>81432206161</b> 81432206190</p> <p><b>81432206055</b> 81432206073 81432206107 81432206104</p>	<p>L=531 T=50 l=130 d=19</p> <p>l=130 p=30 D=70 d=19</p>	TGA - TGS - TGX
<p><b>0807214</b></p>  <p><b>0907259</b></p> 	<p><b>81432206052</b> 81432206010 81432206012 81432206013 81432206020 81432206035 81432206040 81432206041 81432206056 81432306018 81432306028</p> <p><b>81432206055</b> 81432206073 81432206107 81432206104</p>	<p>L=565 d=19</p> <p>l=130 p=30 D=70 d=19</p>	F7 - F8 - F90

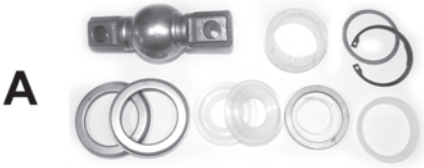





**BARRE DI REAZIONE - TORQUE RODS**

RIF. OCAP OCAP REF.	RIF. ORIG O.E. NUMBER	NOTE REMARKS	MODELLO / DESCRIZIONE MODEL / DESCRIPTION
<p><b>0807559</b></p> 	<p><b>81432206129</b> 81432206097 81432206098 81432209129 81432306014 81432306030 81432206096 81432206137</p>	<p>L=571  d=19</p>	<p>M 90 - M 2000 - F 90</p>
<p><b>0907258</b></p> 	<p><b>81432206108</b> 81432206132</p>	<p>l=130 p=30 D=65 d=19</p>	
<p><b>0907757</b></p> 	-	D=65	senza perno (without pin)
<p><b>0807407</b></p> 	<p><b>81432206382</b> 81432206272 81432206305 81432209267 81432206267 81432206401 81432206236 81432209236 81432206304 81432209272</p>	<p>L=572 T=48 l=130 d=19</p>	H - TGA - TGS - TGX
<p><b>0907407</b></p> 	<p><b>85.43220.6002</b> 85432206002</p>	<p>l=130  D=74,9 d=19</p>	
<p><b>0807811</b></p> 	<p><b>81432206067</b> 81432206068 81432206090 81432206092 81432209092</p>	<p>L=590  d=19</p>	F 90 - F 2000 - TGA
<p><b>0907259</b></p> 	<p><b>81432206055</b> 81432206073 81432206107 81432206104</p>	<p>l=130 p=30 D=70 d=19</p>	

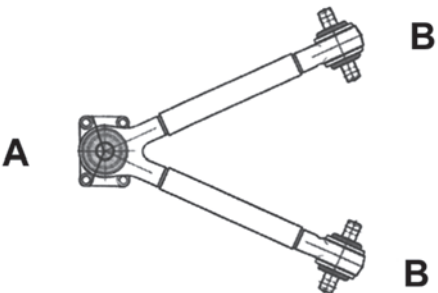
**BARRE DI REAZIONE - TORQUE RODS**

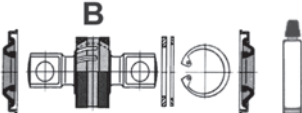
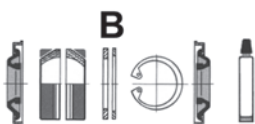





RIF. OCAP OCAP REF.	RIF. ORIG O.E. NUMBER	NOTE REMARKS	MODELLO / DESCRIZIONE MODEL / DESCRIPTION
<p><b>0807824</b></p> 	<p><b>81432206140</b> 81432209140</p>	<p>L=596  d2=18,5 d1=19</p>	<p>M 90: 12.152-12.192-12.222-12.232 12.262-12.272-14.152-14.162 14.192-14.222-14.232-14.262 14.272 M 2000: 14.163-14.224-14.264-14.284 15.163-15.224-15.264-15.284</p>
<p><b>0907258</b></p> 	<p><b>81432206108</b> 81432206132</p>	<p>l=130 p=30 D=65 d=19</p>	
<p><b>0907757</b></p> 	-	D=65	senza perno (without pin)
<p><b>0807906</b></p> 	<p><b>81432206196</b> 81432206232</p>	<p>L=596  d=19</p>	TGA - TGS - TGX - F 2000
<p><b>0907906</b></p> 	<p><b>81432206250</b></p>	<p>l=130  d=19</p>	
<p><b>0807833</b></p> 	<p><b>81432206070</b> 81432206071 81432206072 81432206091 81432206093</p>	<p>L=620 T=58 l=130 d=19</p>	F 90 - F 2000 - TGA - TGS - TGX
<p><b>0907919</b></p> 	<p><b>81432706119</b> 81432206241</p>	D=75	

**BARRE DI REAZIONE - TORQUE RODS**



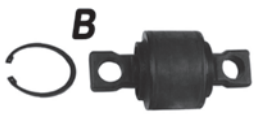



RIF. OCAP OCAP REF.	RIF. ORIG O.E. NUMBER	NOTE REMARKS	MODELLO / DESCRIZIONE MODEL / DESCRIPTION
<p><b>0807533</b></p> 	<p><b>81432706078</b> 81432706030 81432706034 81432706054 81432706055 81432706057 81432706074 81432706076 81432709054 81432709078</p>	<p>L=621  d=23</p>	<p>F 7 - F 8 - F 90 - F 2000 M 90 - M 2000 Unterflur</p>
<p><b>0907533</b></p> 	<p><b>81953016132</b></p>	<p>L=61  IK=46 D=80</p>	
<p><b>0907534</b></p> 	<p><b>81953016133</b></p>	<p>l=152 p=35 D=80 d=23</p>	
<p><b>0907722</b></p> 		<p>D=80</p>	<p>senza perno (without pin)</p>
<p><b>0807907</b></p> 	<p><b>81432706117</b></p>	<p>L=627  d=19</p>	<p>TGA - TGX</p>
<p><b>0907533</b></p> 	<p><b>81953016132</b></p>	<p>L=61  IK=46 D=80</p>	
<p><b>0907907</b></p> 	<p><b>81432706105</b></p>	<p>l=130  p=24,3 d=25</p>	



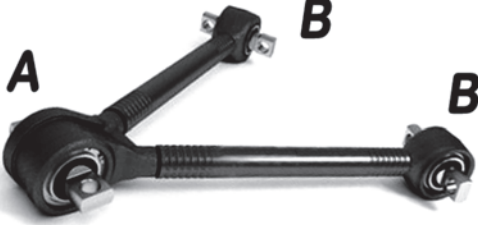





**BARRE DI REAZIONE - TORQUE RODS**

RIF. OCAP OCAP REF.	RIF. ORIG O.E. NUMBER	NOTE REMARKS	MODELLO / DESCRIZIONE MODEL / DESCRIPTION
<p><b>0807839</b></p> 	<p><b>81432706087</b> 81432706094 81432706088 81432706095</p>	<p>L=627 T=48</p>	<p>F 2000 - TGA - TGS - TGX</p>
<p><b>0907774</b></p> 	<p><b>81432706110</b> 0003502405 41272706 Z</p>	<p>l=152 p=24 D=80 d=25</p>	
<p><b>0907907</b></p> 	<p><b>81432706105</b></p>	<p>l=130 p=24,3 d=25</p>	
<p><b>0807840</b></p> 	<p><b>81432206221</b> 81432706096 81432706114 81432706121</p>	<p>L=627 T=48</p>	<p>TGA - TGS - TGX</p>
<p><b>0907533</b></p> 	<p><b>81953016132</b></p>	<p>L=61 IK=46 D=80</p>	
<p><b>0907840</b></p> 	<p><b>81432706126</b> 81432706123 81432706118</p>	<p>l=130 p=30 D=85 d=23</p>	







**BARRE DI REAZIONE - TORQUE RODS**

RIF. OCAP OCAP REF.	RIF. ORIG O.E. NUMBER	NOTE REMARKS	MODELLO / DESCRIZIONE MODEL / DESCRIPTION
<p><b>0807841</b></p> 	<p><b>81432706137</b> 81432706116 81432706150 81432706151</p>	<p>L=627 T=48</p>	<p>F 2000 - TGA - TGS - TGX</p>
<p><b>0907774</b></p> 	<p><b>81432706110</b> 0003502405 41272706 Z</p>	<p>l=152 p=24 D=80 d=25</p>	
<p><b>0907907</b></p> 	<p><b>81432706105</b></p>	<p>l=130  p=24,3 d=25</p>	
<p><b>0807842</b></p> 	<p><b>81432706097</b> 81432706113 81432706135 81432706160 81432706161</p>	<p>L=627 T=46</p>	<p>F 2000 - TGA - TGS - TGX</p>
<p><b>0807807</b></p> 	<p><b>81432206174</b></p>	<p>L=644 T=50</p>	<p>M 2000 L - M 2000 M</p>
<p><b>0907258</b></p> 	<p><b>81432206108</b> 81432206132</p>	<p>l=130 p=30 D=65 d=19</p>	







**BARRE DI REAZIONE - TORQUE RODS**

RIF. OCAP OCAP REF.	RIF. ORIG O.E. NUMBER	NOTE REMARKS	MODELLO / DESCRIZIONE MODEL / DESCRIPTION
<p><b>0807847</b></p> 	<p><b>81432706055</b> 81432706056 81432706075 81432706077 81432709056 81432706067 81432706068 81432706081</p>	<p>L=627 T=58</p>	<p>F 2000 - F 90</p>
<p><b>0907533</b></p> 	<p><b>81953016132</b></p>	<p>L=61 IK=46 D=80</p>	
<p><b>0907686</b></p> 	<p><b>81432706079</b> 276192</p>	<p>I=152 p=24 D=80 d=23</p>	
<p><b>0807801</b></p> 	<p><b>81432206213</b></p>	<p>L=660 T=38</p>	<p>M 2000 L - M 2000 M</p>
<p><b>0907339</b></p> 	<p><b>81432206213</b></p>	<p>I=100 p=24 D=67 d=15</p>	
<p><b>0807846</b></p> 	<p><b>81432706053</b> 81432709053</p>	<p>L=693 T=46</p>	<p>M 2000 M - M 90</p>
<p><b>0907406</b></p> 	<p><b>81.43270.6065</b> 81432706065</p>	<p>D=65</p>	



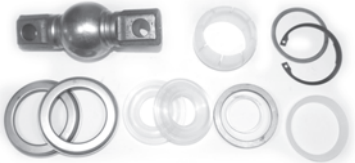



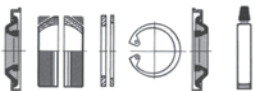

**BARRE DI REAZIONE - TORQUE RODS**

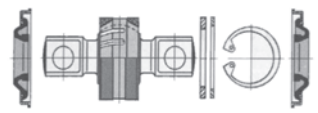
RIF. OCAP OCAP REF.	RIF. ORIG O.E. NUMBER	NOTE REMARKS	MODELLO / DESCRIZIONE MODEL / DESCRIPTION
<p><b>0907846</b></p> <p><b>B</b> </p>	<p><b>81432706091</b> 1498132</p>	<p>l=115 p=24 D=75 d=19</p>	
<p><b>0807810</b></p> <p><b>A</b>  <b>A</b></p> <p><b>0907216</b></p> <p><b>A</b> </p>	<p><b>81432306039</b> 81432306038 81432309039 81991648156</p> <p><b>81432306043</b></p>	<p>L=755  d=19</p> <p>l=130 p=30 D=65 d=19</p>	
<p><b>0807818</b></p> <p><b>A</b>  <b>A</b></p> <p><b>0907528</b></p> <p><b>A</b> </p>	<p><b>81432206082</b> 81432206083 81432206084 81432206106 81432206147 81432306049</p> <p><b>81432306051</b> 81432306068</p>	<p>L=777 T=60 l=115 d=17</p> <p>l=115 p=24 D=62 d=17</p>	F 2000 - F 90 - M 2000 L - M 2000 M - M 90
<p><b>0807817</b></p> <p><b>A</b>  <b>A</b></p> <p><b>0907528</b></p> <p><b>A</b> </p>	<p><b>81432206222</b> 81432206260 81432206283 81432206284</p> <p><b>81432306051</b> 81432306068</p>	<p>L=941 T=48 l=115 d=17</p> <p>l=115 p=24 D=62 d=17</p>	TGA - TGS - TGX





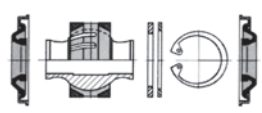

**KIT DI SOSPENSIONE - SUSPENSION KITS**

RIF. OCAP OCAP REF.	RIF. ORIG O.E. NUMBER	NOTE REMARKS	MODELLO / DESCRIZIONE MODEL / DESCRIPTION
<b>0907919</b> 	<b>81432706119</b> 81432206241	D=75	E 2000 - F 2000 - F90 TGA - TGS - TGX
<b>0907757</b> 	-	D=65	M 90 - M 2000 - F 90
<b>0907906</b> 	<b>81432206250</b>	l=130  d=19	TGA - TGS - TGX - F 2000
<b>0907258</b> 	<b>81432206108</b> 81432206132	l=130 p=30 D=65 d=19	F 90 - M 90 - M 2000 L - M 2000 M
<b>0907216</b> 	<b>81432306043</b>	l=130 p=30 D=65 d=19	F 7-F 8 F 90-M 90-TGA-TGS-TGX
<b>0907533</b> 	<b>81953016132</b>	L=61  IK=46 D=80	TGA - TGS - TGX - F 2000 - F 90
<b>0907259</b> 	<b>81432206055</b> 81432206073 81432206107 81432206104	l=130 p=30 D=70 d=19	F7 - F8 - F90 - TGA - TGX
<b>0907722</b> 		D=80	F 7 - F 8 - F 90 - F 2000 - M 90 - M 2000 - senza perno (without pin)

**KIT DI SOSPENSIONE - SUSPENSION KITS**

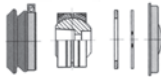
RIF. OCAP OCAP REF.	RIF. ORIG O.E. NUMBER	NOTE REMARKS	MODELLO / DESCRIZIONE MODEL / DESCRIPTION
<b>0907330</b> 	<b>81432706045</b> 81432706040	l=152 p=24 D=80 d=21	Bus
<b>0907534</b> 	<b>81953016133</b>	l=152 p=35 D=80 d=23	F 7 - F 8 - F 90 - F 2000 M 90 - M 2000 Unterflur
<b>0907339</b> 	<b>81432206213</b>	l=100 p=24 D=67 d=15	M 2000L - M 2000 L
<b>0907405</b> 	<b>81432206202</b>	l=100  D=67 d=17	L 2000 - M 2000 L
<b>0907406</b> 	<b>81.43270.6065</b> 81432706065	D=65	F 90 - M 2000 L - M 2000 M
<b>0907407</b> 	<b>85.43220.6002</b> 85432206002	l=130  D=74,9 d=19	TGA-TGS-TGX
<b>0907907</b> 	<b>81432706105</b>	l=130  p=24,3 d=25	F 2000 - TGA - TGS - TGX
<b>0907770</b> 	<b>81432506009</b>	L=60  D=40 d=20	G 90 - L 2000 - TGL
<b>0907528</b> 	<b>81432306051</b> 81432306068	l=115 p=24 D=62 d=17	F 90-F 2000 M 90-M 2000

**KIT DI SOSPENSIONE - SUSPENSION KITS**

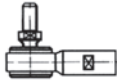
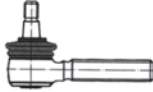
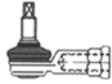
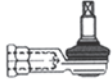

RIF. OCAP OCAP REF.	RIF. ORIG O.E. NUMBER	NOTE REMARKS	MODELLO / DESCRIZIONE MODEL / DESCRIPTION
<b>0907846</b> 	<b>81432706091</b> 1498132	l=115 p=24 D=75 d=19	F 90 - M 2000 M - M 2000 F - M 90
<b>0907686</b> 	<b>81432706079</b> 276192	l=152 p=24 D=80 d=23	F90 - F2000 - TGA
<b>0907683</b> 	<b>81432706080</b>	D=80  IK=46	F90 - F2000 - TGA
<b>0907820</b> 	<b>81432206322</b>	l=130 p=30 D=72 d=23	TGA - TGS - TGX
<b>0907774</b> 	<b>81432706110</b> 0003502405 41272706 Z	l=152 p=24 D=80 d=25	F 2000 - TGA - TGS - TGX
<b>0907840</b> 	<b>81432706126</b> 81432706123 81432706118	l=130 p=30 D=85 d=23	TGA - TGS - TGX

**TESTE COMANDO CAMBIO - GEAR BOX CONTROL BALL JOINTS**

RIF. OCAP OCAP REF.	RIF. ORIG O.E. NUMBER	NOTE REMARKS	MODELLO / DESCRIZIONE MODEL / DESCRIPTION
<p><b>0287294</b></p> 	<p><b>90804105207</b></p>	<p>L=35</p> <p>M=10x1</p>	<p>TGS - TGX</p>
<p><b>0187228</b></p> 	<p><b>81953010038</b> 81953010045 81953016016 81953016169 81953016172 81953016176 81953016266 81953016235 81953016302</p>	<p>L=85</p> <p>M=14 x 1,5 RH</p>	<p>F 90 - M 90 - M 2000 Unterflur</p>
<p><b>0287229</b></p> 	<p><b>81953016064</b> 81953016130 81953016170 81953016173</p>	<p>L=55</p> <p>M=12x1,75 RH</p>	<p>F 90 - F 2000 - G 90 L 2000 - M 90 - M 2000 TGA</p>
<p><b>0297229</b></p> 	<p><b>81953016063</b> 81953016131 81953016171 81953016174</p>	<p>L=55</p> <p>M=12x1,75 LH</p>	<p>F 90 - F 2000 - G 90 L 2000 - M 90 - M 2000 TGA</p>





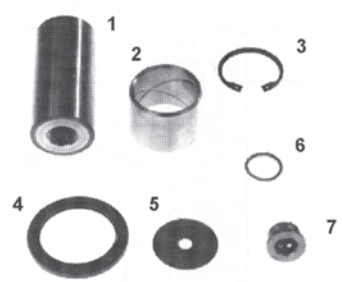

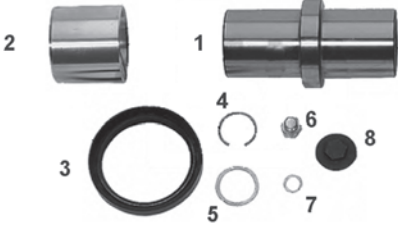

**KIT PERNO FUSO - KING PIN SET**

RIF. OCAP OCAP REF.	RIF. ORIG O.E. NUMBER	NOTE REMARKS	MODELLO / DESCRIZIONE MODEL / DESCRIPTION
<p><b>0927742</b></p> 	<p><b>81.44205.6016</b>                      81442050048 (1)                      81907120067 (2)                      81907120068 (3)                      81907120069 (4)                      81907120070 (5)                      81907120071 (6)                      81907120072 (7)                      06290200127 (8)                      81930210139 (9)                      06327190034 (10)                      06290200127 (11)                      06562790291 (12)                      06380702202 (13)</p>	<p>L=174  D=34,5/35</p>	<p>G90</p>
<p><b>0927406</b></p> 	<p><b>81.44205.6009</b>                      81442050041 (1)                      81930200708 (2)                      81930200707 (3)                      06328190016 (4)                      - (5)                      06290200130 (6)                      06563414505 (7)                      06562790278 (8)                      81907110940 (9)                      06380702202 (10)</p>	<p>L=213  D=44,5/45</p>	<p>M90</p>
<p><b>0927408</b></p> 	<p><b>81.44205.6013</b></p>	<p>L=223  D=49,5/50</p>	<p>F 2000 F 90 - F 90 UNTERFLUR M 2000 M 90</p>
<p><b>0927409</b></p> 	<p>-                      81.363050015 (1)                      81.930200482 (2)                      06.290200130 (3)                      06.562790025 (4)                      - (5)                      81.364060016 (6)                      81.903100234 (7)</p>	<p>L=109  D=50</p>	<p>F 90 - F 2000 - L 2000 - M 2000 - TGA E 2000</p>















**KIT PERNO FUSO - KING PIN SET**

RIF. OCAP OCAP REF.	RIF. ORIG O.E. NUMBER	NOTE REMARKS	MODELLO / DESCRIZIONE MODEL / DESCRIPTION
<p><b>0927410</b></p> 	<p>- 81.363050016 (1) 81.930200460 (2) 06.562790181 (3) - (4) 06.281600319 (5) 06.080922142 (6) 06.561800715 (7) 81.903100198 (8)</p>	<p>L=119  D=50/64</p>	<p>F 2000 F 90 ASSE/AXLE: V7 - 90L - VA7 - VAD7 - VA9 E 2000 - L2000 - M2000 TGA</p>

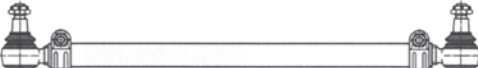





**BARRE ACCOPPIAMENTO - TIE RODS**

RIF. OCAP OCAP REF.	RIF. ORIG O.E. NUMBER	NOTE REMARKS	MODELLO / DESCRIZIONE MODEL / DESCRIPTION
<p><b>0507618</b></p>  <p><b>0186424</b> M=30x1,5 RHT</p>	<p><b>4243300303</b> 4243300503</p>	<p>L=1170 T=46</p>	<p>UNIMOG: U 1000-U 1200-U 1250- U 1400 U 1450-U 1550</p>
<p><b>0507610</b></p>  <p><b>0186424</b>      <b>0196424</b> M=30x1,5 RHT    M=30x1,5 LHT</p>	<p><b>3913300603</b> 3913300803 3913301003 3913301203</p>	<p>L=1190 T=40</p>	<p>NG - SK - MK</p>
<p><b>0507636</b></p>  <p><b>0186424</b> M=30x1,5 RHT</p>	<p><b>4253300003</b> 4373300003 4373300403</p>	<p>L=1315 T=50</p>	<p>UNIMOG: U 1300-U 1500-U 1700-U 1750 U 1800-U 1850-U 2100-U 2150 U 2400-U 2450-U 5000</p>
<p><b>0507786</b></p>  <p><b>0186595</b>      <b>0196595</b> M=24x1,5 RHT    M=24x1,5 LHT</p>	<p><b>3163300603</b> 3163300203 3163300503 3163300703</p>	<p>L=1454</p>	<p>LP LP: 608-709-809-811-813-913 LPL: 608-709-809-813-913 LP LPK: 608-709-808-809-813-913 LP LPKF: 608-709-808 LP LPS: 608-709-811-813-913 LPLS: 608-709-813</p>
<p><b>0507651</b></p>  <p><b>0186551</b>      <b>0196961</b> M=30x1,5 RHT    M=30x1,5 LHT</p>	<p><b>9453300503</b> 9453300203 9453300303</p>	<p>L=1465</p>	<p>ACTROS - ACTROS MP2 - MP3 ATEGO - ATEGO II AXOR - AXOR 2 - ECONIC</p>
<p><b>0507792</b></p>  <p><b>0186424</b>      <b>0196424</b> M=30x1,5 RHT    M=30x1,5 LHT</p>	<p><b>6763300803</b> 6763301003 6763300503 6763300303</p>	<p>L=1546</p>	<p>LK/LN2: 814F/L/S-817/F/LS/S-914/K/KO-917/K/KO 1114/K/L/S-1117/K/LS/S-1120/F/L/LS/S 1124/F-1317/K/LS</p>





**BARRE ACCOPPIAMENTO - TIE RODS**

RIF. OCAP OCAP REF.	RIF. ORIG O.E. NUMBER	NOTE REMARKS	MODELLO / DESCRIZIONE MODEL / DESCRIPTION
<b>0507647</b>   <b>0186598</b> M=30x1,5 RHT <b>0196598</b> M=30x1,5 LHT 	<b>3433300303</b> 3433300403 3433300103	L=1550	ATEGO I/II 2628 - ECONIC 2628 L/LS/LK: 1621-1924 LK/LS: 2624 (6x4)-LA: 2624 (6x6) L/LK: 2628 (6x4) - MK: 1824 - 1827 NG: 1626-1632-1622-1628-1719-1919 1926-1932-2026-2032-2226-2232-2626 2632
<b>0507790</b>   <b>0186613</b> M=28x1,5 RHT <b>0196613</b> M=28x1,5 LHT 	<b>6763300703</b> 6763300203 6763300403 6763300603 6763300903	L=1550	ATEGO I: 817 LK/LN2: 709/K-711-809/K-811/K-814/F/K/L/S 817/F/K/L/LS/S-914/K/KO-917/K 1117/L-1317/K
<b>0507788</b>   <b>0186424</b> M=30x1,5 RHT	<b>6763301103</b> 6763300103 6763301203	L=1555	709/K-809/K-814/F/L/K/S 817F/L/S-914AK/K-917AF 1114-1117A-1120
<b>0506586</b>   <b>0186424</b> M=30x1,5 RHT <b>0196424</b> M=30x1,5 LHT 	<b>6773300303</b> 6773300403	L=1562	LK/LN2: 817/L/LO-1114/K 1117/L/LO/K/S-1120/F 1124/F-1314/K/KO-1317/K/KO/LS 1320/L-1324/L-1514/K
<b>0507910</b>   <b>0187467</b> M=38x1,5 RHT	<b>6253301203</b> 6253300903 9443300203	L=1588 T=60	ACTROS 1996 > - ACTROS MP2 / MP3-MP3 AXOR 2 - NG - SK
<b>0507969</b>   <b>0186599</b> M=30x1,5 RHT	<b>9443300503</b> 9443301303	L=1588 T=60	ACTROS - ACTROS MP2/MP3 - ATEGO AXOR 2 - SK





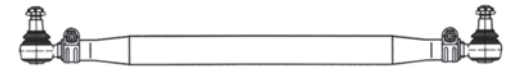

**BARRE ACCOPPIAMENTO - TIE RODS**

RIF. OCAP OCAP REF.	RIF. ORIG O.E. NUMBER	NOTE REMARKS	MODELLO / DESCRIZIONE MODEL / DESCRIPTION
<p><b>0507669</b></p>  <p><b>0186599</b> M=30x1,5 RHT</p>	<p><b>3463303903</b> 3463304903 6253303203 9443301703</p>	<p>L=1588 T=58</p>	<p>ACTROS - ACTROS MP2/MP3 - ATEGO AXOR 2 - NG - SK</p>
<p><b>0507437</b></p>  <p><b>0186598</b> M=30x1,5 RHT</p>	<p><b>6253303203</b> 9443301703 3463303903 3463304903</p>	<p>L=1588 T=58</p>	<p>ACTROS - ACTROS MP2 / MP3 - ATEGO - AXOR 2</p>
<p><b>0507653</b></p>  <p><b>0186612</b> M=24x1,5 RHT    <b>0196612</b> M=24x1,5 LHT</p>	<p><b>6703300203</b> 6703300303 6703300103 6703300003 6703300403 6703300503</p>	<p>L=1594</p>	<p>T2/LN1 (507 D &gt; 510) VARIO: 512 D &gt; 818 D (667 - 668 - 670)</p>
<p><b>0507436</b></p>  <p><b>0186551</b> M=30x1,5 RHT    <b>0196961</b> M=30x1,5 LHT</p>	<p><b>9493301003</b> 9493301103 9493301703</p>	<p>L=1596 T=50</p>	<p>ACTROS - ACTROS MP2 / MP3 - AXOR</p>
<p><b>0501499</b></p>  <p><b>0180727</b> M=20x1,5 RHT    <b>0190727</b> M=20x1,5 LHT</p>	<p><b>6673300603</b></p>	<p>L=1600</p>	<p>T2/LN1 (507 D &gt; 510) VARIO: 512 D &gt; 818 D (667 - 668 - 670)</p>
<p><b>0507975</b></p>  <p><b>0186598</b> M=30x1,5 RHT    <b>0196598</b> M=30x1,5 LHT</p>	<p><b>9753300203</b> 9753300303 9753300803 9753301703 9753302503</p>	<p>L=1607 T=40</p>	<p>ATEGO - ATEGO 2</p>





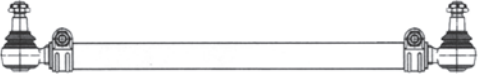









**BARRE ACCOPPIAMENTO - TIE RODS**

RIF. OCAP OCAP REF.	RIF. ORIG O.E. NUMBER	NOTE REMARKS	MODELLO / DESCRIZIONE MODEL / DESCRIPTION
<p><b>0507657</b></p>  <p><b>0186424</b>      <b>0196424</b> M=30x1,5 RHT    M=30x1,5 LHT</p>	<p><b>3853301403</b> 3853300503 3853301503 3853301103 3853300603</p>	L=1611	<p>380-381 383/385 617/651 MK - NG</p>
<p><b>0507795</b></p>  <p><b>0186598</b>      <b>0196598</b> M=30x1,5 RHT    M=30x1,5 LHT</p>	<p><b>6173300203</b> 6173300303</p>	L=1611	<p>LK/LN2:1520/L-1524/L MK:1417/K-1420/L/LS-1422/F/LS/S 1424L-1426LS/S-1717K/L-1720/L/S 1722/K/L/S-1820/L-2433/L-2534/L NG:1414/K-1417/C/CK-1419/C/CL 1420/L/LS-1422/L/LS/S-1425/LS/S 1614K-1617/C/CK/CL/CS-1619/C/CC 1622/K/L/S</p>
<p><b>0507591</b></p>  <p><b>0186551</b>      <b>0196961</b> M=30x1,5 RHT    M=30x1,5 LHT</p>	<p><b>6253302403</b> 6253302503 6253301503 6253301603 9493300903 9493300203 9423300803 9493300303</p>	L=1615	<p>ACTROS:3231B-3235B-3240B-3243B ACTROS MP2 - MP3 ATEGO II - AXOR II MK NG SK</p>
<p><b>0507658</b></p>  <p><b>0186598</b>      <b>0196598</b> M=30x1,5 RHT    M=30x1,5 LHT</p>	<p><b>3933300303</b> 3933300003 3933300403 3933300203 3503307203</p>	L=1620	<p>371/385-387/389 393/397-398/616 617/619-620/621 623/624-645-659 - 1922 - 2044 MK - NG: 1626-1632-1935 SK: 1935 LK - LN2 - SK ACTROS - UNIMOG U52</p>
<p><b>0507655</b></p>  <p><b>0186613</b> M=28x1,5 RHT</p>	<p><b>3523302303</b> 3523301903 3523302003 3523302403 3523301603</p>	L=1626	<p>352/353-358/360 387/389-395-621/624 649/655-656/659 SK: 2629-3553</p>

**BARRE ACCOPPIAMENTO - TIE RODS**

RIF. OCAP OCAP REF.	RIF. ORIG O.E. NUMBER	NOTE REMARKS	MODELLO / DESCRIZIONE MODEL / DESCRIPTION
<p><b>0507793</b></p>  <p><b>0186424</b> M=30x1,5 RHT</p>	<p><b>3853301603</b> 3853300803 3853301803 3853300203</p>	<p>L=1635</p>	<p>LK/LN2: 917/AK MK:1222/AF-1224/AF NG:1013/A/AF-1017/A/AF/AK/AK/AS 1019AF-1213A/AK/AKO/AS-1217A/AK/AS 1219/A/AF/AK-1222/A/AF-1225/AF 1413/A/AK/AKO-1417/A/AKO/CA/CAK 1419/AK/AS-1617AK/CAK-1619/AK 1622/AK-1625/AK-1628/L</p>
<p><b>0506167</b></p>  <p><b>0186424</b> M=28x1,5 RHT    <b>0196424</b> M=28x1,5 LHT</p>	<p><b>9703300003</b> 9703300103 9703300203 9703300303 9703300403</p>	<p>L=1635</p>	<p>ATEGO I - II</p>
<p><b>0507218</b></p>  <p><b>0186598</b> M=30x1,5 RHT</p>	<p><b>3853301303</b> 3853302103 3853302203 3853302403</p>	<p>L=1635 T=60</p>	<p>NG - LK/LN2 - MK</p>
<p><b>0507605</b></p>  <p><b>0186613</b> M=28x1,5 RHT    <b>0196613</b> M=28x1,5 LHT</p>	<p><b>3813300503</b> 3813300603 3813300303 3813300703 3583300103 3583300503</p>	<p>L=1638 T=46</p>	<p>LK/LN2 - LP - NG</p>
<p><b>0507620</b></p>  <p><b>0186612</b> M=24x1,5 RHT    <b>0196612</b> M=24x1,5 LHT</p>	<p><b>3583300703</b> 3273300103 3273300303 3273300403 3273300803</p>	<p>L=1648</p>	<p>L/LS: 1113-1116 LK/LP/LPK/LPS: 321 LP: 911 LPO: 344/1113</p>
<p><b>0507979</b></p>  <p><b>0186551</b> M=30x1,5 RHT    <b>0196961</b> M=30x1,5 LHT</p>	<p><b>9423300403</b> 9423301603 9423302403</p>	<p>L=1664 T=50</p>	<p>ACTROS - ACTROS MP2/MP3 - ATEGO - AXOR 2</p>

**BARRE ACCOPPIAMENTO - TIE RODS**





RIF. OCAP OCAP REF.	RIF. ORIG O.E. NUMBER	NOTE REMARKS	MODELLO / DESCRIZIONE MODEL / DESCRIPTION
<b>0507886</b>   <b>0186551</b> M=30x1,5 RHT <b>0196961</b> M=30x1,5 LHT 	<b>9423300303</b> 9423300403 9423301603	L=1664 T=50	ACTROS - ACTROS MP2/MP3 - ATEGO - AXOR 2
<b>0507593</b>   <b>0186598</b> M=30x1,5 RHT <b>0196598</b> M=30x1,5 LHT 	<b>6203300503</b> 6203300603 6203300003	L=1665	MK:1422F-1717L-1720/L-1722/L-1726/L-1733L-1820/L-1827/L-1831/L-1834/L-2024L-2420-2422/L-2433/L-2527L-2531L-2534/L NG:1422/L-1617C/CL-1619C/CL-1620/L-1622/L-1625L-1628/L-1633/L-1635/L-1636L-1644-1928L-2219C/CL-2220/L-2222L-2228L-2233/L-2235L-2244/L SK:1729/K/L-1735/5L-1748/8L/LS/S-1831/LS/S-1834L/LS-1838L/LS/S-1840/LS
<b>0507603</b>   <b>0186551</b> M=30x1,5 RHT	<b>9493300603</b> 9493300703 9493301503 9493301603 9493302003 9493302403	L=1687 T=52	ACTROS - ACTROS MP2 / MP3 - ATEGO - AXOR 2
<b>0507604</b>   <b>0186551</b> M=30x1,5 RHT	<b>9493300403</b> 9493300503 9493300803 9493301403 9493301903 9493302303	L=1700 T=52	ACTROS - ACTROS MP2 / MP3 - ATEGO - AXOR 2
<b>0507643</b>   <b>0186551</b> M=30x1,5 RHT <b>0196961</b> M=30x1,5 LHT 	<b>9413300103</b> 9413300203 9413300303 9413300503	L=1735 T=50	ACTROS - ACTROS MP2/MP3 - ATEGO - AXOR - AXOR 2
<b>0507916</b>   <b>0187916</b> M30x1,5 RHT	<b>9453300003</b> 9453300103 9453300403 9453300603	L=1735 T=62	ACTROS - ACTROS MP2 - MP3





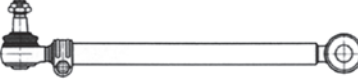

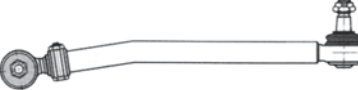
**BARRE ACCOPPIAMENTO - TIE RODS**

RIF. OCAP OCAP REF.	RIF. ORIG O.E. NUMBER	NOTE REMARKS	MODELLO / DESCRIZIONE MODEL / DESCRIPTION
<p><b>0507633</b></p>  <p><b>0186551</b> M=30x1,5 RHT</p>	<p><b>9423300203</b> 0014600005 0014600105 9423300003 9423300103 9423300703 9423302303 9423301103 9423301803 9423302003</p>	<p>L=1735</p>	<p>ACTROS - ACTROS MP2 - MP3 ATEGO AXOR I - AXOR II ECONIC: 1823-2628-1828 SK</p>





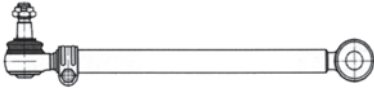

TIRANTI LONGITUDINALI - DRAG LINKS

RIF. OCAP OCAP REF.	RIF. ORIG O.E. NUMBER	NOTE REMARKS	MODELLO / DESCRIZIONE MODEL / DESCRIPTION
<p><b>0502257</b></p>  <p><b>0180730</b> M=22x1,5 RHT</p> <p><b>0190731</b> M=22x1,5 LHT</p>	<p><b>6014601505</b> 6014600505 6014600605 6014600705 6014600805 6014600905 6014601005 6014601105 6014601205 6014601305</p>	<p>L = 450</p>	<p>T1: 207D-208-209D-210 307D-308-309D-310 601-602 T1/TN: 408-409-410</p>
<p><b>0500730</b></p>  <p><b>0180730</b> M=22x1,5 RHT</p>	<p><b>6014600305</b> 3094600305 3094602905 3094603005 3094603105 3094603205 6014600005 6014600105 6014600205</p>	<p>L=486</p>	<p>T1: 207-210-307 T2/L: 207-208-210-307-310 406-407-408-409-410 508-608</p>
<p><b>0507659</b></p>  <p><b>0186613</b> M=28x1,5 RHT</p>	<p><b>6704602605</b> 6704602705</p>	<p>L=495</p>	<p>T2/LN1</p>
<p><b>0507624</b></p>  <p><b>0186613</b> M=28x1,5 RHT</p>	<p><b>6704602805</b> 6704602905</p>	<p>L=495 T=32</p>	<p>T2/LN1: 709-711-714-809-811-814</p>
<p><b>0507826</b></p>  <p><b>0187560</b> M=24x1,5 RHT</p>	<p><b>6684602305</b> 6684602405</p>	<p>L=495 T=28</p>	<p>T2/LN1 - VARIO</p>







TIRANTI LONGITUDINALI - DRAG LINKS

RIF. OCAP OCAP REF.	RIF. ORIG O.E. NUMBER	NOTE REMARKS	MODELLO / DESCRIZIONE MODEL / DESCRIPTION
<p><b>0507960</b></p>  <p><b>0187560</b> M=24x1,5 RHT</p>	<p><b>6684602105</b> 6684602205</p>	<p>L=495 T=28</p>	<p>T2/LN1 - VARIO</p>
<p><b>0507608</b></p>  <p><b>0186613</b> M=28x1,5 RHT</p>	<p><b>6674601605</b> 6674601805</p>	<p>L=504 T=34</p>	<p>VARIO</p>
<p><b>0507660</b></p>  <p><b>0187560</b> M=24x1,5 RHT</p>	<p><b>6684600905</b> 6684600505 6684600705 6684601105</p>	<p>L=505</p>	<p>T2/LN1: 609/611/711/709</p>
<p><b>0507656</b></p>  <p><b>0187560</b> M=24x1,5 RHT</p>	<p><b>6684601705</b> 6684601905</p>	<p>L=505</p>	<p>T2/LN1 MOD.: 609-611-668-669 709-711-714 VARIO MOD.: 512 D</p>
<p><b>0507898</b></p>  <p><b>0186613</b> M=28x1,5 RHT</p>	<p><b>6704602205</b> 6704601805 6704600905</p>	<p>L=505 T=32</p>	<p>T2/LN1: 507 D - 507 DK - 508 D - 510 709 D - 709 DK - 711 D - 714 D 809 D - 809DK - 811 D - 811 DK - 814 D</p>
<p><b>0507625</b></p>  <p><b>0186547</b> M=30x1,5 RHT</p>	<p><b>3164600805</b> 3164600605 3164600705 3164600905 3164800806</p>	<p>L=530</p>	<p>LK/LN2: 709-809-811 LP LP:811-813 LP LPK:813 LP LPS 811-813 LPLS: 813 LPL:813 NG: 1013</p>



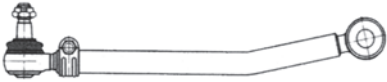

TIRANTI LONGITUDINALI - DRAG LINKS

RIF. OCAP OCAP REF.	RIF. ORIG O.E. NUMBER	NOTE REMARKS	MODELLO / DESCRIZIONE MODEL / DESCRIPTION
<b>0507621</b> 	<b>3524606705</b> 3524602305 3524602405 3524606805	L=610	LA/LAS/LAK: 1313-1314-1317
<b>0507607</b> 	<b>3524607105</b> 3524603705 3524606605	L=655 T=36	-
<b>0507662</b> 	<b>3524605505</b> 3524602905 3524604605 3524602105	L=668	352-353 358-360
<b>0507663</b> 	<b>3524605805</b> 3524603005 3524604705	L=668	352-353 358-360
<b>0507971</b>  <b>0187971</b> M=30x1,5 RHT <b>0197971</b> M=30x1,5 LHT	<b>0004606005</b> 0004606305	L=685 T=40	MK - NG - SK
<b>0507661</b>  <b>0186424</b> M=30x1,5 RHT	<b>3734600905</b> 3024600505 3024600605 3024603905 3024604005 3734600605	L=687	373 O 302
<b>0507698</b>  <b>0186598</b> M=30x1,5 RHT <b>0196598</b> M=30x1,5 LHT	<b>6224600905</b> 6224601005 6224600205 6224600305	L=700	MK - NG

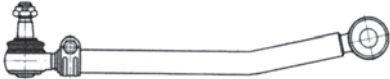
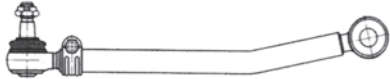

TIRANTI LONGITUDINALI - DRAG LINKS

RIF. OCAP OCAP REF.	RIF. ORIG O.E. NUMBER	NOTE REMARKS	MODELLO / DESCRIZIONE MODEL / DESCRIPTION
<p><b>0507440</b></p> 	<p><b>0014605305</b> 0024600605</p>	<p>L=708 T=40</p>	<p>ACTROS - ACTROS MP2 / MP3</p>
<p><b>0507961</b></p> 	<p><b>0014601105</b> 0024600405 0034603105</p>	<p>L=711 T=42</p>	<p>ACTROS - ACTROS MP2/MP3 - ATEGO - AXOR - AXOR 2 - ECONIC</p>
<p><b>0506583</b></p>  <p><b>0186547</b> M=30x1,5 RHT</p>	<p><b>6734600605</b> 6734600205 6734600405 6734600805</p>	<p>L=725</p>	<p>LK/LN2:709-709K-711 809-809K-811-811K 814/F/L/LO/O/S 817/F/K/L/LO/LS/O/S 914/K/O-917/K-1317K/S</p>
<p><b>0507828</b></p>  <p><b>0186547</b> M=30x1,5 RHT</p>	<p><b>6734600305</b> 6734600505 6734600705 6734600905</p>	<p>L=725 T=36</p>	<p>LK/LN2</p>
<p><b>0506581</b></p>  <p><b>0187146</b> M=30x1,5 RHT</p>	<p><b>6754602405</b> 6754601205 6754601805 6754603005 6754603305</p>	<p>L=727</p>	<p>914 ATEGO I: 917 - 1217 LK/LN2:817LO/S-917KO 1114L/K/LO/O/S 1117/L/LO/LS/K/O 1120/L/LO/LS/O/S-1217KO NG: 1217</p>
<p><b>0507587</b></p>  <p><b>0186551</b>      <b>0196961</b> M=30x1,5 RHT    M=30x1,5 LHT</p>	<p><b>0014601505</b> 0014607305 0034603305 3754601605</p>	<p>L=733 T=36</p>	<p>ACTROS - ACTROS MP2/MP3 - AXOR 2</p>
<p><b>0507617</b></p>  <p><b>0187959</b> M=30x1,5 RHT</p>	<p><b>4054600005</b> 4054600305 4054600605</p>	<p>L=753 T=42</p>	<p>UNIMOG U 300 - U 400</p>





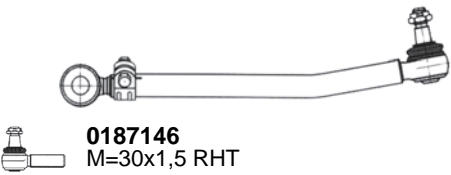
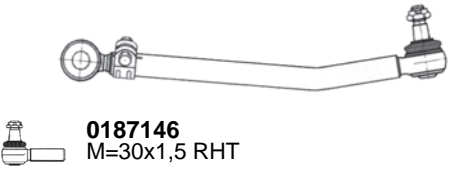
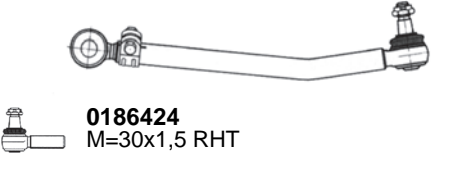
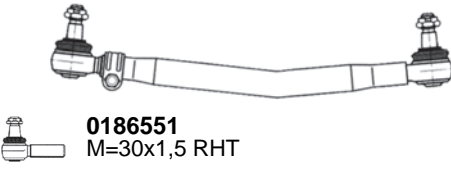

TIRANTI LONGITUDINALI - DRAG LINKS

RIF. OCAP OCAP REF.	RIF. ORIG O.E. NUMBER	NOTE REMARKS	MODELLO / DESCRIZIONE MODEL / DESCRIPTION
<p><b>0507664</b></p>  <p><b>0186598</b> M=30x1,5 RHT</p>	<p><b>3434601405</b> 3434601205 3434601505 3434601005 3434600405 3434600805</p>	L=760	<p>MK: 2422/2522/2524/2527/L ATEGO I: 2628 - ATEGO II: 2628 ECONIC: 1624-1928-2628</p>
<p><b>0507665</b></p>  <p><b>0187146</b> M=30x1,5 RHT</p>	<p><b>3464600005</b> 3464600105 3464605005 3354600005</p>	L=770	LK/LN2 - NG
<p><b>0507966</b></p>  <p><b>0186551</b> M=30x1,5 RHT    <b>0196961</b> M=30x1,5 LHT</p>	<p><b>0034603505</b> 0014605705</p>	L=773 T=36	ACTROS - ACTROS MP2/MP3
<p><b>0507787</b></p>  <p><b>0187146</b> M=30x1,5 RHT</p>	<p><b>6754602605</b> 6754601405 6754602005 6754603205</p>	L=777	LK/LN2: 914-917-1114-1117-1120-1124
<p><b>0506576</b></p>  <p><b>0187146</b> M=30x1,5 RHT</p>	<p><b>6754602205</b> 6754601005 6754601605 6754602805</p>	L=780	ATEGO: 1317 - 1514 LK/LN2: 914-1114-1114K-1117K/L/LO/LS/S 1120-1120F/L/LS/S-1124F-1314-1314K 1317-1317L/LS/S-1320-1320L/LS/S
<p><b>0506577</b></p>  <p><b>0187146</b> M=30x1,5 RHT</p>	<p><b>6764601105</b> 6764600105 6764600605 6764601505</p>	L=780	LK/LN2: 1114K/L/S 1117-1117K/L 1120-1120F-1124F 1314-1314K/KO 1317-1317K/L/LS/S 1320-1320K/L/LS/S/ UT 1324-1324L/LS/S-1620

TIRANTI LONGITUDINALI - DRAG LINKS







RIF. OCAP OCAP REF.	RIF. ORIG O.E. NUMBER	NOTE REMARKS	MODELLO / DESCRIZIONE MODEL / DESCRIPTION
<p><b>0507701</b></p>  <p><b>0187146</b> M=30x1,5 RHT</p>	<p><b>6764601205</b> 6764600205 6764600705 6764601605</p>	<p>L=780</p>	<p>LK/LN2: 1120/F-1124/F 1314/K/KO-1317/K/L/LS/S 1320/L/LS/S-1324/L/LS/S</p>
<p><b>0507639</b></p>  <p><b>0187146</b> M=30x1,5 RHT</p>	<p><b>6764601905</b> 6764602105</p>	<p>L=783</p>	<p>LK/LN2: 1314KO-1514/K/L 1517/K/L-1520/L-1524/L</p>
<p><b>0507794</b></p>  <p><b>0186424</b> M=30x1,5 RHT</p>	<p><b>6764603105</b></p>	<p>L=783</p>	<p>LK/LN2: 1117-1314K/KO-1317K/KO/L/LS/S 1320L/LS/S-1324L/LS/S-1514K/L 1517K/L-1520/L-1524/L</p>
<p><b>0507594</b></p>  <p><b>0186551</b> M=30x1,5 RHT</p>	<p><b>0014600305</b> 0014600405</p>	<p>L=795</p>	<p>MK: 1424/L/LS/S-1427F-1720/L 1733/L/LS/S-1820/L-1824/K/L 1827/L/LS/S-1831/L/LS/S-1834/L/LS/S 2433/L-2524/L-2531/L-2534/L SK:1722/1734/1735/1834/L</p>
<p><b>0507970</b></p>  <p><b>0186598</b> M=30x1,5 RHT</p>	<p><b>0004601005</b> 0004601105</p>	<p>L=825 T=50</p>	<p>MK</p>
<p><b>0507978</b></p>  <p><b>0186551</b> M=30x1,5 RHT    <b>0196961</b> M=30x1,5 LHT</p>	<p><b>0034603805</b> 0014606505</p>	<p>L=827 T=36</p>	<p>ACTROS - ACTROS MP2/MP3</p>

TIRANTI LONGITUDINALI - DRAG LINKS

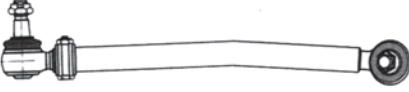



RIF. OCAP OCAP REF.	RIF. ORIG O.E. NUMBER	NOTE REMARKS	MODELLO / DESCRIZIONE MODEL / DESCRIPTION
<p><b>0507439</b></p>  <p><b>0186424</b> M=30x1,5 RHT</p>	<p><b>9724601405</b> 9724601605</p>	<p>L=837 T=40</p>	<p>ATEGO - ATEGO 2</p>
<p><b>0506582</b></p>  <p><b>0186551</b> M=30x1,5 RHT</p>	<p><b>0014602905</b> 0014603005</p>	<p>L=840</p>	<p>MK - SK</p>
<p><b>0507613</b></p>  <p><b>0186424</b> M=30x1,5 RHT</p>	<p><b>9704600905</b> 9704600705</p>	<p>L=846 T=42</p>	<p>ATEGO - ATEGO 2</p>
<p><b>0507614</b></p>  <p><b>0187959</b> M=30x1,5 RHT</p>	<p><b>0034605705</b> 0024609605 0024609705</p>	<p>L=858 T=40</p>	<p>ACTROS - ACTROS MP2 / MP3 - AXOR 2</p>
<p><b>0507695</b></p>  <p><b>0186551</b> M=30x1,5 RHT</p>	<p><b>0014602105</b> 0004602705 0014602205</p>	<p>L=860</p>	<p>MK: 2433-2534</p>
<p><b>0507972</b></p>  <p><b>0186551</b> M=30x1,5 RHT</p>	<p><b>9574600505</b> 9574600705</p>	<p>L=860 T=50</p>	<p>ECONIC</p>







TIRANTI LONGITUDINALI - DRAG LINKS

RIF. OCAP OCAP REF.	RIF. ORIG O.E. NUMBER	NOTE REMARKS	MODELLO / DESCRIZIONE MODEL / DESCRIPTION
<p><b>0506578</b></p>  <p><b>0186598</b> M=30x1,5 RHT</p>	<p><b>6194605205</b> 6194602505 6194602905</p>	L=860	<p>ACTROS: 1831 1520-1625-1625S-1625L/LS-1628L 2219C/CL(6x2)-1826-2220C-2220L 2222(6x2)6x4)-2225-2425-2828-3025 3025K-3028-3228-1831</p>
<p><b>0507804</b></p>  <p><b>0186598</b> M=30x1,5 RHT</p>	<p><b>6194605305</b> 6194602705 6194603105 0014609705 6194601205</p>	L=860	<p>MK: 1424L/LS/S-1417F-1717K/L/S 1720L-1722K/L/S-1726K/L/LS/S 1733L/LS-1820K/L-1824K/L-1827LS/L/S 1831L/LS/S-1834LS/S-2420L-2422B/K/L 2426B-2433K/L-2524K/L-2527B/K/L 2531L-2534K/L NG:1614K-1617C/CK/CL/CS-1619C/CL 1620L-1622K/L/S-1625K/L/LS/S-1628L 2219C/CL-2220L-2222K/L-2225B-2228L</p>
<p><b>0507592</b></p>  <p><b>0186598</b> M=30x1,5 RHT</p>	<p><b>6174603405</b> 6174602405 6174602005</p>	L=863	<p>MK: 1222A/AF/AK-1226AF-1227A 1234AF-1417A/AK-1717/AK 1722AK-1726AK-1820AK 1824AK-2433-2433L 2524-224L-2531L-2534-2534L NG:1222A-1222AF-1417CA/CAK 1617CAK-1622AK-1625AK</p>
<p><b>0506580</b></p>  <p><b>0187146</b> M=30x1,5 RHT</p>	<p><b>3874604405</b> 3874600605 3874604505</p>	L=865	<p>NG: 1626/LS/S-1632/LS/S-1719/S 1919S-1926S-1932S-2026(6x2) (6x4) 2032(6x2)(6x4)-2226L/S(6x2)-2232LS(6x4) 2626S/K(6x4)2632/S(6x4)-3332</p>
<p><b>0506962</b></p>  <p><b>0186598</b> M=30x1,5 RHT</p>	<p><b>6474600005</b> 3874600705 6474600105 3874603305 3874601405 3874603205</p>	L=865	ACTROS
<p><b>0507671</b></p>  <p><b>0186598</b> M=30x1,5 RHT</p>	<p><b>3874601505</b> 3874603505 3874603605 6474600205 6474600305</p>	L=865 T=42	MK - NG - SK





**TIRANTI LONGITUDINALI - DRAG LINKS**

RIF. OCAP OCAP REF.	RIF. ORIG O.E. NUMBER	NOTE REMARKS	MODELLO / DESCRIZIONE MODEL / DESCRIPTION
<p><b>0507590</b></p>  <p><b>0186598</b> M=30x1,5 RHT</p>	<p><b>6204602905</b> 6204603005</p>	<p>L=865</p>	<p>ACTROS - ATEGO I/II - ECONIC - MK - NG AK - AS</p>
<p><b>0507632</b></p>  <p><b>0186598</b> M=30x1,5 RHT</p>	<p><b>0024606405</b> 0014609805 0014609905</p>	<p>L=866</p>	<p>ACTROS - ACTROS MP2 - MP3 ATEGO - AXOR ECONIC: 2628</p>
<p><b>0507825</b></p>  <p><b>0187146</b> M=30x1,5 RHT</p>	<p><b>6174600105</b> 6174600305 6174602905</p>	<p>L=870 T=42</p>	<p>NG</p>
<p><b>0507626</b></p>  <p><b>0187146</b> M=30x1,5 RHT</p>	<p><b>6174602805</b> 6174600005 6174600205</p>	<p>L=870</p>	<p>16.12-16.17-16.19-16.20-16.22 MK: 1417-1420-1422 NG: 1222-1417-1419-1420-1422-1425 1612-1919-1922</p>
<p><b>0507666</b></p>  <p><b>0186598</b> M=30x1,5 RHT</p>	<p><b>6174603505</b> 6174603605</p>	<p>L=870</p>	<p>MK: 1420/LS-1722/AK/K/L/S NG: 1614/K-1617/CK/CS-1622/AK/K 1625/AK/K/L/LS/S</p>







TIRANTI LONGITUDINALI - DRAG LINKS

RIF. OCAP OCAP REF.	RIF. ORIG O.E. NUMBER	NOTE REMARKS	MODELLO / DESCRIZIONE MODEL / DESCRIPTION
<p><b>0507640</b></p>  <p><b>0186598</b> M=30x1,5 RHT</p>	<p><b>6254602505</b></p>	<p>L=870</p>	<p>NG: 1622/L-2222/L-2235/L-26287A-2635/A 2636/AK-2644/S-3028/B/K-3336/AK/K 3328/B/K-3535AK/K SK: 1729/K/L/LS-1735/K/L/LS-1748/L/LS/S 1831/K/L/LS/S-1834/L/LS-1838/AK/K/L/LS 1840/LS-1844/L/LS-1850/L/LS/S 1853/AK/L/LS-1922/K/S-1929/A/AS/K/L/S 1935/K/S-1948-2024/K-2031/K/S-2038/S 2044/S-2050/S-2429/K/L/LS/S</p>
<p><b>0507629</b></p>  <p><b>0186598</b> M=30x1,5 RHT</p>	<p><b>0004609305</b> 0004609205 0014606905</p>	<p>L=873</p>	<p>ACTROS - ACTROS MP2 - MP3 ATEGO AXOR I/II:2535-2540-2543 ECON IC: 1823-2628-1828 MK-NG-SK</p>
<p><b>0507631</b></p>  <p><b>0180730</b> M=22x1,5 RHT</p>	<p><b>0024604805</b> 0024604705 0034604905</p>	<p>L=876</p>	<p>ACTROS - MP2 - MP3 ATEGO AXOR: 2535-2540-2543 - AXOR 2 ECONIC: 2628 MK-N-G-SK</p>
<p><b>0507611</b></p>  <p><b>0186424</b> M=30x1,5 RHT</p>	<p><b>4244600305</b> 4274600005 4274600105 4274600305 4274600405</p>	<p>L=877 T=38</p>	<p>UNIMOG U 1000-U 1200-U 1250-U 1400 U 1450-U 1550-U 1600-U 1650</p>
<p><b>0506585</b></p>  <p><b>0186598</b> M=30x1,5 RHT</p>	<p><b>0004607105</b> 0004607205 0014606705 0074607205</p>	<p>L=879</p>	<p>ACTROS - MP2 - MP3 ATEGO I-II AXOR I-II ECONIC</p>







**TIRANTI LONGITUDINALI - DRAG LINKS**

RIF. OCAP OCAP REF.	RIF. ORIG O.E. NUMBER	NOTE REMARKS	MODELLO / DESCRIZIONE MODEL / DESCRIPTION
<p><b>0507630</b></p>  <p><b>0187789</b> M=28x1,5 RHT</p>	<p><b>0024604405</b> 0024604305 0034604805</p>	L=879	ACTROS - ACTROS MP2 - MP3 ATEGO AXOR - AXOR II
<p><b>0506579</b></p>  <p><b>0187146</b> M=30x1,5 RHT</p>	<p><b>3874604805</b> 3874600005 3874604905</p>	L=880	NG:1626S-1632S-1719S-1919S-1926S 1932S-2626S (6x4)-1935-2226-2232 2626K (6x4)-2632-3332
<p><b>0506575</b></p>  <p><b>0186598</b> M=30x1,5 RHT</p>	<p><b>6204602805</b> 6204600005 6204602005 6204603705 3933200632 3874600405 3874605005</p>	L=885	ACTROS-ATEGO I-ATEGO II ECONIC-NG-MK-SK
<p><b>0507912</b></p>  <p><b>0186551</b> M=30x1,5 RHT</p>	<p><b>0024605205</b> 0024605105 0034604005</p>	L=885	ACTROS 1996 > - ACTROS MP2-MP3 AXOR 2
<p><b>0507805</b></p>  <p><b>0186598</b> M=30x1,5 RHT</p>	<p><b>6204603805</b> 6204600105 6204602105 6204603905</p>	L=885	NG - SK - UNIMOG







TIRANTI LONGITUDINALI - DRAG LINKS

RIF. OCAP OCAP REF.	RIF. ORIG O.E. NUMBER	NOTE REMARKS	MODELLO / DESCRIZIONE MODEL / DESCRIPTION
<p><b>0507973</b></p>  <p><b>0186598</b> M=30x1,5 RHT</p>	<p><b>0024601705</b> 0024607505 0024607605 0034604405 3754601705</p>	<p>L=886 T=38</p>	<p>ATEGO - AXOR 2</p>
<p><b>0507642</b></p>  <p><b>0187959</b> M=30x1,5 RHT</p>	<p><b>0034601805</b> 0034601905 0034605805</p>	<p>L=888 T=42</p>	<p>ACTROS MP2</p>
<p><b>0507968</b></p>  <p><b>0186598</b> M=30x1,5 RHT</p>	<p><b>0014600705</b> 0014600805 0014607005</p>	<p>L=888 T=38</p>	<p>ACTROS</p>
<p><b>0506963</b></p>  <p><b>0187146</b> M=30x1,5 RHT</p>	<p><b>3834604405</b> 3834601405 3834602305 3834600605</p>	<p>L=890</p>	<p>MK - ATEGO I - NG</p>
<p><b>0506584</b></p>  <p><b>0186547</b> M=30x1,5 RHT</p>	<p><b>3834604505</b> 3834601605 3834602405 3834600805</p>	<p>L=890</p>	<p>NG</p>
<p><b>0507696</b></p>  <p><b>0187146</b> M=30x1,5 RHT</p>	<p><b>3834606605</b> 3834606705 3834602108 3834600705</p>	<p>L=890</p>	<p>NG: 1625/K/L/LS/S</p>

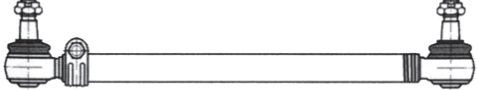





TIRANTI LONGITUDINALI - DRAG LINKS

RIF. OCAP OCAP REF.	RIF. ORIG O.E. NUMBER	NOTE REMARKS	MODELLO / DESCRIZIONE MODEL / DESCRIPTION
<p><b>0507441</b></p>  <p><b>0186551</b> M=30x1,5 RHT</p>	<p><b>0014604905</b> 0014607405</p>	<p>L=893 T=42</p>	<p>ACTROS - ACTROS MP2 / MP3</p>
<p><b>0507887</b></p>  <p><b>0186598</b> M=30x1,5 RHT</p>	<p><b>0034604605</b> 3754600005 9744601005 9744601205</p>	<p>L=894 T=50</p>	<p>ATEGO - ATEGO 2</p>
<p><b>0507434</b></p>  <p><b>0186598</b> M=30x1,5 RHT</p>	<p><b>0034606005</b> 9724601905 9724602105</p>	<p>L=894 T=50</p>	<p>ATEGO - ATEGO 2</p>
<p><b>0507963</b></p>  <p><b>0186598</b> M=30x1,5 RHT</p>	<p><b>0034604705</b> 9744601105 9744601305 0034600705</p>	<p>L=894 T=50</p>	<p>ATEGO - ATEGO 2</p>
<p><b>0507615</b></p>  <p><b>0187959</b> M=30x1,5 RHT</p>	<p><b>0024604905</b> 0024605005 0034605605</p>	<p>L=895 T=40</p>	<p>ACTROS - ATEGO - AXOR - AXOR 2</p>
<p><b>0507827</b></p>  <p><b>0186598</b> M=30x1,5 RHT</p>	<p><b>0034605905</b> 9724601805 9724602005</p>	<p>L=895 T=50</p>	<p>ATEGO - ATEGO 2</p>

TIRANTI LONGITUDINALI - DRAG LINKS





RIF. OCAP OCAP REF.	RIF. ORIG O.E. NUMBER	NOTE REMARKS	MODELLO / DESCRIZIONE MODEL / DESCRIPTION
<p><b>0507789</b></p>  <p><b>0187789</b> M=28x1,5 RHT</p>	<p><b>0024604505</b> 0024604605 3754600405 0034605005</p>	<p>L=895</p>	<p>ACTROS-ACTROS MP2 - MP3 ATEGO AXOR - AXOR II</p>
<p><b>0507627</b></p>  <p><b>0186598</b> M=30x1,5 RHT</p>	<p><b>0004609805</b> 0004609905</p>	<p>L=900</p>	<p>SK: 1735/L-1748/L-1844/L-1850/L 1853/L-1929/L-1948-2024-2031/S-2038/S 2044/S-2050/S-2429/K/S-2435/S-2448/L/S 2538/K/L/LS/S-2544/L/LS/S-2550/L/S 2553/L/S-2629/B/K/S-2631/B/S-2635/K/S 2638/K-2644/S-2628/K-2650/K</p>
<p><b>0507670</b></p>  <p><b>0186598</b> M=30x1,5 RHT</p>	<p><b>6204602405</b> 6204602605 6204604005 6204604105</p>	<p>L=900 T=48</p>	<p>NG - SK</p>
<p><b>0507967</b></p>  <p><b>0186551</b> M=30x1,5 RHT</p>	<p><b>0004609505</b> 0014607105</p>	<p>L=904 T=52</p>	<p>ACTROS - ACTROS MP2/MP3</p>
<p><b>0507829</b></p>  <p><b>0186551</b> M=30x1,5 RHT</p>	<p><b>0014604205</b></p>	<p>L=905 T=48</p>	<p>SK</p>
<p><b>0507584</b></p>  <p><b>0186551</b> M=30x1,5 RHT</p>	<p><b>0024605305</b> 0024605405</p>	<p>L=905 T=38</p>	<p>ATEGO - AXOR 2</p>

TIRANTI LONGITUDINALI - DRAG LINKS





RIF. OCAP OCAP REF.	RIF. ORIG O.E. NUMBER	NOTE REMARKS	MODELLO / DESCRIZIONE MODEL / DESCRIPTION
<p><b>0507637</b></p>  <p><b>0187789</b> M=28x1,5 RHT</p>	<p><b>0034605105</b> 0024607705 0024607805</p>	<p>L=916 T=36</p>	<p>ATEGO - AXOR</p>
<p><b>0507965</b></p>  <p><b>0186551</b> M=30x1,5 RHT</p>	<p><b>0024605905</b> 0024606005 0034604105</p>	<p>L=935 T=38</p>	<p>ACTROS - ACTROS MP2/MP3</p>
<p><b>0507974</b></p>  <p><b>0186551</b> M=30x1,5 RHT</p>	<p><b>0034604505</b> 0024609305 0024609205</p>	<p>L=953 T=42</p>	<p>ACTROS - ACTROS MP2/MP3</p>
<p><b>0507962</b></p>  <p><b>0186551</b> M=30x1,5 RHT</p>	<p><b>0024606105</b> 0024606205 0034604205</p>	<p>L=958 T=38</p>	<p>ACTROS - ACTROS MP2/MP3 - ATEGO - AXOR 2</p>
<p><b>0507667</b></p>  <p><b>0186424</b> M=30x1,5 RHT</p>	<p><b>3734600705</b> 3024600305 3024603505 3024603605 3734600505 3734600305</p>	<p>L=976</p>	<p>373 O 302/S</p>
<p><b>0507612</b></p>  <p><b>0186424</b> M=30x1,5 RHT</p>	<p><b>4254600105</b> 4254600205 4254600305 4254600405 4374600005 4374600105</p>	<p>L=995 T=38</p>	<p>UNIMOG U 1300-U 1350-U 1500-U 1550 U 1700-U 1750-U 1800-U 1850 U 2100-U 2150-U 2400-U 2450</p>







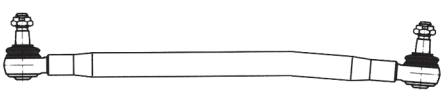

TIRANTI LONGITUDINALI - DRAG LINKS

RIF. OCAP OCAP REF.	RIF. ORIG O.E. NUMBER	NOTE REMARKS	MODELLO / DESCRIZIONE MODEL / DESCRIPTION
<p><b>0507976</b></p>  <p><b>0187342</b> M=24x1,5 RHT</p>	<p><b>4064600105</b></p>	<p>L=1015 T=36</p>	<p>UNIMOG</p>
<p><b>0507964</b></p> 	<p><b>0014605505</b> 0034603405 0035603405</p>	<p>L=1057 T=40</p>	<p>ACTROS - ACTROS MP2/MP3</p>
<p><b>0507911</b></p> 	<p><b>0014601305</b> 3754601505 0024600505 0014601405 0034603205</p>	<p>L=1095</p>	<p>ACTROS 1996 &gt; - ACTROS MP2-MP3 AXOR 2 - ATEGO</p>
<p><b>0507628</b></p> 	<p><b>0004604405</b> 6254605005</p>	<p>L=1115</p>	<p>MK: 1717/L-1733/L-1834/L-2433/L-2531/L-2534/L NG: 2628/A-2635-2636/K-2644/S-3028/K-3228/K 3336/K-3535/AK SK: 1729K/LS/S-1735/K/LS/LS/S-1748/L/LS/S 1831/K/L/LS/S-1834/L/LS/S-1834/L/LS/S 1838/AK/K/L/LS/S-1840/LS-1844/L/LS/S 1850/L/LS/S-1853/AK/L/LS/S-1922/K/S 1929/A/AS/K/L/S-1935/K/S-1948-2024/K</p>
<p><b>0507641</b></p> 	<p><b>0004606605</b></p>	<p>L=1130</p>	<p>MK: 1420/LS-1422/F/L-1424/LS/S-1717/L 1720/L-1722/L-1726/L/S-1733/L-1820/L 1824/L-1824/L-1827/L-1831/L-1834/L 2433/L-2527/L-2531/L-2534/L NG: 1622/L-2222/L-2235/L2635-2644/S SK: 1729/K/L/LS/S-1735/L/LS/S-1748/L/LS/S 1831/K/L/LS/S-1834/L/LS/S 1838/AK/K/L/LS/S-1840/LS-1844/L/LS/S 1850/L/LS/S-1853/AK/L/LS-S-1922/K</p>

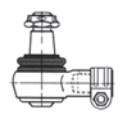



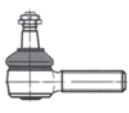

TIRANTI LONGITUDINALI - DRAG LINKS

RIF. OCAP OCAP REF.	RIF. ORIG O.E. NUMBER	NOTE REMARKS	MODELLO / DESCRIZIONE MODEL / DESCRIPTION
<p><b>0507694</b></p>  <p><b>0186551</b> M=30x1,5 RHT</p>	<p><b>0004604105</b> 0004605505 6254604205 6254607805 6994602405</p>	L=1242	<p>MK:1726/L-A831/L NG: 3035B/K (8x4)- 3228B/K (8x4) SK: 3229B/K (8x4)- 3233B/K (8x4) 3234B/K (8x4)- 3534/K (8x4)</p>
<p><b>0507652</b></p>  <p><b>0180729</b> M=24x1,5 RHT    <b>0190729</b> M=24x1,5 LHT</p>	<p><b>3093301903</b> 3093301203 3093301403 3093301603 3093301703 3093301803 3093302003 3093302103 309331303</p>	L=1476	<p>T2/L: 406DG-407D-408D/DG/G 409G-410-508DG-608D</p>
<p><b>0507697</b></p> 	<p><b>3914601705</b> 3914600905 3914601805</p>	L=1826	<p>MK: 1733/LS/S-1834/LS/S-2433/LS/S 2534/LS/S NG: 1325/L-1628/L/LS/S-1633/LS/S-1635/LS/S 2028/LS--2033/LS-2035/LS-2036/LS-2225 2228/L SK: 1748/LS/S-1838/K/L-1844/LS/S-1850/LS/S 1853LS/S-1929A/AL/S-2429/LS/S-2435LS/S 2448/LS-2538/LS/S-2544/LS/S</p>
<p><b>0507700</b></p> 	<p><b>6254601405</b> 6254604005 6254609605 6254609805 6994603705 6994603905 6994604005</p>	L=1955	<p>NG: 1622/L-2225/B-2228/A 3025/B/K-3228/B/K-3535/AK</p>
<p><b>0507977</b></p> 	<p><b>4608505</b> 24601005 34602905 0004608505 0024601005 0034602905</p>	L=2069 T=42	<p>ACTROS - ACTROS MP2/MP3</p>

TESTE STERZO - TIE RODS END

RIF. OCAP OCAP REF.	RIF. ORIG O.E. NUMBER	NOTE REMARKS	MODELLO / DESCRIZIONE MODEL / DESCRIPTION
<b>0287361</b> 	<b>0004634429</b> 0009964845 0014607048 A0004634429 A0009964845	L=75  M=26x1,5 RHT	NG - SK
<b>0287313</b> 	<b>6244600348</b>	L=85  M=26x1,5 RHT	NG - SK
<b>0180727</b> 	<b>6013305335</b> 6013300635	L=95  M=20x1,5 RHT	T2/LN1 (507 D > 510) VARIO: 512 D > 818 D (667 - 668 - 670)
<b>0190727</b> 	<b>6013300535</b> 6013300735 6013305235	L=95  M=20x1,5 LHT	T2/LN1 (507 D > 510) VARIO: 512 D > 818 D (667 - 668 - 670)
<b>0186595</b> 	<b>0003308535</b> 0003300335 0003300635 0003302410 0004633229 0003308735 0003306735	L=95  M=24x1,5 RHT	608-709-709K-711-808-809-811-813 911B-913-914-917-1013-1114-1117 1120 Unimog U -NG: 1013-1017 LK/LN2: 814-817-914-917 ATEGO I: 815-817-823-917-923-925 1017-1023
<b>0196595</b> 	<b>0003308635</b> 0003300235 0003300735 0003308835 0003306835	L=95  M=24x1,5 LHT	608-709-709K-711-808-809-811-813 911B-913-914-917-1013-1114-1117 1120 Unimog U -NG: 1013-1017 LK/LN2: 814-817-914-917 ATEGO I: 815-817-823-917-923-925 1017-1023
<b>0187560</b> 	<b>0013301435</b> 0003301035 0003381610 0013301235 0003301135 0003301635	L=95  M=24x1,5 RHT	T2/LN1: 507/D/DK-508/D-510-609/D/DK 611/D/DK-709/D/DK-711/D-714/D VARIO: 512/D
<b>0180730</b> 	<b>3103301335</b> 0004608548 0004604148 0003305035 0004604348 0004602148 0004604542	L=95  M=22x1,5 RHT	NG - SK - T1 - T2/L 601 - 602 - TN1 - TN T2/L - LK
<b>0182260</b> 	<b>4603301235</b> 0004607248 0013304835	L=95  M= 20x1,5 RHT	100 (Furgonato) G-Class (Fuoristrada aperto/open off-road) G-Class W 460-W 461-W463 (Fuoristrada chiuso/close off-road)

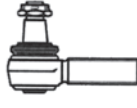



**TESTE STERZO - TIE RODS END**

RIF. OCAP OCAP REF.	RIF. ORIG O.E. NUMBER	NOTE REMARKS	MODELLO / DESCRIZIONE MODEL / DESCRIPTION
<b>0287684</b>  	<b>0004604948</b> 0004634629 0024600948	L=95  M=26x1,5 RHT	ATEGO - ACTROS MP2 - AXOR - SK
<b>0186612</b>  	<b>0003309735</b> 0003309935 0003301235 0003307535 0003383429 0003383529	L=105  M=24x1,5 RHT	T2 - 507D/DK-508D-510-609D/DK 611D-709D/DK-711D-714D-809D/DT/DK 811 D/DT/DK-814D NG: 1013 - VARIO: 512D-612D-613D-615D 812D-813D-814D-815D-816D-815DA-816DA
<b>0196612</b>  	<b>0003309835</b> 0003301335 0003307635 0013300035 0023301435	L=105  M=24x1,5 LHT	T2: 507D/DK-508D-510-609D/DK 611D-709D/DK-711D-714D-809D/DT/DK 811 D/DT/DK-814 D
<b>0186613</b>  	<b>0003309335</b> 0003301435 0003301535 0003307135 0003309535 0003382129	L=105  M=28x1,5 RHT	ATEGO I - PS - LK - NG - T2
<b>0196613</b>  	<b>0003309435</b> 0003303335 0003307235 0003309635	L=105  M=28x1,5 LHT	ATEGO I - PS - LK - NG - T2
<b>0187342</b>  	<b>0004604348</b> 0003381810 0003305635 0004605648 3103300635 3103301035 3103301235	L=105  M=24x1,5 RHT	T2/L: 508/DG-608/D-613/D Unimog U
<b>0186424</b>  	<b>0014603448</b> 0013300235 0013300135 0004633529 0004633429 0004608348 0003383410 0003307335 0003305835 0003303235 0003300248 3503307035 0014632229 3024633429 0014609748	L=115  M=30x1,5 RHT	ATEGO I ACTROS - ACTROS MP2 - MP3 AXOR LK MK NG







**TESTE STERZO - TIE RODS END**

RIF. OCAP OCAP REF.	RIF. ORIG O.E. NUMBER	NOTE REMARKS	MODELLO / DESCRIZIONE MODEL / DESCRIPTION
<b>0196424</b> 	<b>0013308835</b> 0003300148 3023300035 3023300135 3023300235 3023300335 0003300035 3503307135 0024600248	L=115  M=30x1,5 LHT	ATEGO I ACTROS - ACTROS MP2 - MP3 AXOR LK MK NG
<b>0186547</b> 	<b>0013300335</b> 0013300435 0003303135 0003308135	L=115  M=30x1,5 RHT	LK - LP - LPK - LPS - NG
<b>0187959</b> 	<b>0014603848</b> 0014604848 0014605148 0014608648 0014609948	L=115  M=30x1,5 RHT	ACTROS - ANTOS - AXOR
<b>0187146</b> 	<b>0004602648</b> 0004600148 0004602748	L=120  M=30x1,5 RHT	LK/LN2 - NG
<b>0186598</b> 	<b>0004602848</b> 0004602248 0004602948 0014600248 0004600348 0014600848 0014601248 0004608948 0014600948 0014602248 0014607748 0024600148	L=120  M=30x1,5 RHT	ACTROS - MP2 - MP3 ATEGO - ATEGO 2 AXOR II - LK - LN2 MK - NG - SK
<b>0196598</b> 	<b>0004603448</b> 0004600648 0004603548 0004601248 0014601448 0014600348 0014602348 0014603748 0024600348	L=120  M=30x1,5 LHT	ACTROS - MP2 - MP3 ATEGO - AXOR II - LK - LN2 MK - NG - SK
<b>0186551</b> 	<b>0004606848</b> 0004605748 0004606048 0004607048 0014601148 0014607648 0014600448 0014601748 0014609648	L=120  M=30x1,5 RHT	ACTROS - ACTROS MP2 - MP3 ATEGO AXOR I - AXOR II ECONIC MK-NG-SK





**TESTE STERZO - TIE RODS END**

RIF. OCAP OCAP REF.	RIF. ORIG O.E. NUMBER	NOTE REMARKS	MODELLO / DESCRIZIONE MODEL / DESCRIPTION
<b>0196961</b> 	<b>0004606948</b> 0004605848 0004606148 0004607148 0014600548 0014601348 0014607948 0014602548	L=120  M=30x1,5 LHT	ACTROS - ACTROS MP2 - MP3 ATEGO - AXOR I - AXOR II ECONIC MK-NG-SK
<b>0186599</b> 	<b>0013301835</b>	L=120  M=38x1,5 RHT	ACTROS - ACTROS MP2 - MP3 ATEGO AXOR II NG 2628A/AK/AS-2635A-2636A 3250-3336AK-3535-3850
<b>0187467</b> 	<b>0004601748</b>	L=135  M=38x1,5 RHT	ACTROS/ACTROS MP2 - MP3 ATEGO II NG SK AXOR II
<b>0197467</b> 	<b>6.851.490.000</b> 1203.223.00	L=135  M=38x1,5 LHT	ACTROS/ACTROS MP2 - MP3 ATEGO II NG SK AXOR II
<b>0287136</b> 	<b>0013302135</b> 0013302635 0003304035 0003307735 0003384929 0003302835	L=140  M=35x1,5 RHT	O 303 - O 305 - 0307 - O 340 O 405 - O 407 - O 408 - SK
<b>0297136</b> 	<b>0013302235</b> 0013302735 0003304135 0003307835 0003385029 0003302935	L=140  M=35x1,5 LHT	O 303 - O 305 - 0307 - O 340 O 405 - O 407 - O 408 - SK
<b>0187916</b> 	<b>0014602948</b>	L=146  M30x1,5 RHT	ACTROS MP2 - MP3
<b>0186442</b> 	<b>6994601648</b>	L=154  M=30x1,5 RHT	

**TESTE STERZO - TIE RODS END**

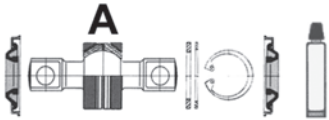

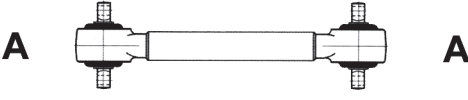
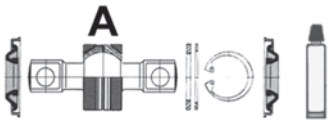

RIF. OCAP OCAP REF.	RIF. ORIG O.E. NUMBER	NOTE REMARKS	MODELLO / DESCRIZIONE MODEL / DESCRIPTION
<b>0187789</b> 	<b>0014604148</b> 0014605048 0014604248 0014608548 0024600548 0014608448 0014608948	L=141  M=28X1,5 RHT	ACTROS - ATEGO - AXOR
<b>0187971</b> 	<b>0004604848</b> 0014600648	L=155  M=30x1,5 RHT	MK - NG - SK
<b>0197971</b> 	<b>0004608448</b> 0014600748	L=155  M=30x1,5 LHT	MK - NG - SK
<b>0180729</b> 	<b>0013300735</b> 0003307035 0013301035 0003302735 0013300935 0003300835 0003302635	L=160  M=24x1,5 RHT	309/310-313-406-407-408 409-410-508-608-613
<b>0190729</b> 	<b>0013300835</b> 0003302635 0003306935	L=160  M=24x1,5 LHT	309/310-313-406-407 408-409-410-508-608-613
<b>0190731</b> 	<b>0004602248</b> 0004608648 0004604648 0004604248 0004608748	L=250  M=22x1,5 LHT	T1: 601-602 (furgonato/van) T1/TN: 407-408-409-410

**BARRE DI REAZIONE - TORQUE RODS**



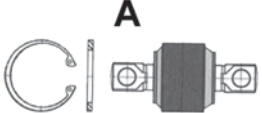
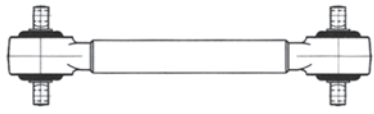
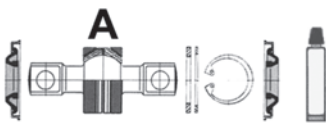
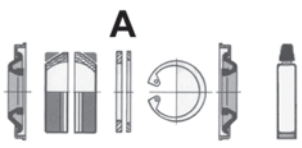
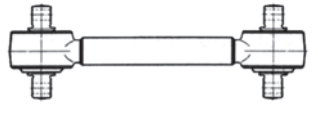

RIF. OCAP OCAP REF.	RIF. ORIG O.E. NUMBER	NOTE REMARKS	MODELLO / DESCRIZIONE MODEL / DESCRIPTION
<p><b>0807642</b></p> 	<p><b>6533500006</b> 3853500006</p>	<p>L=500</p> <p>d=21</p>	<p>MK - NG - 240.35</p>
<p><b>0907556</b></p> 	<p><b>0003500213</b> 0005861433 0003500305 0003500505</p>	<p>l=152 p=24 D=65 d=21</p>	
<p><b>0907586</b></p> 	<p><b>0005861533</b></p>	<p>D=65</p>	<p>senza perno (without pin)</p>
<p><b>0807585</b></p> 	<p><b>6523500306</b> 3813500606 6533500106</p>	<p>L=522</p> <p>d=21</p>	<p>MK - NG - SK</p>
<p><b>0907304</b></p> 	<p><b>0003500613</b> 0005861135 0003501805</p>	<p>l=152 p=24 D=70 d=21</p>	
<p><b>0807825</b></p> 	<p><b>3933200332</b></p>	<p>L=553</p> <p>d=21</p>	<p>1632-2632</p>
<p><b>0907556</b></p> 	<p><b>0003500213</b> 0005861433 0003500305 0003500505</p>	<p>l=152 p=24 D=65 d=21</p>	





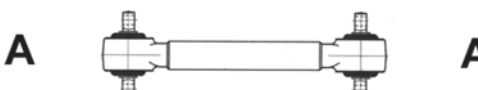
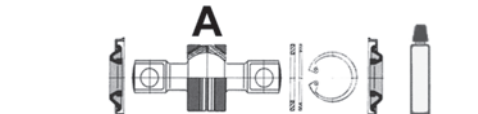
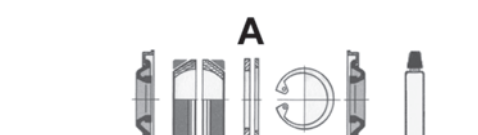

**BARRE DI REAZIONE - TORQUE RODS**

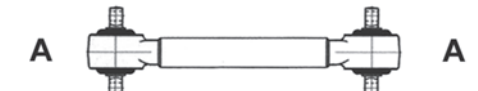
RIF. OCAP OCAP REF.	RIF. ORIG O.E. NUMBER	NOTE REMARKS	MODELLO / DESCRIZIONE MODEL / DESCRIPTION
<p><b>0907586</b></p> 	<b>0005861533</b>	D=65	senza perno (without pin)
<p><b>0807669</b></p> 	<p><b>9483501205</b>                      9483500605                      9483501305                      9483500805                      9473500005                      9453500105                      9483502005                      9483502405</p>	L=565 T=52  d=21	ACTROS - MP2 - MP3 ATEGO - AXOR - AXOR II
<p><b>0907547</b></p> 	<b>0003502705</b>	l=152  D=70 d=21	
<p><b>0807606</b></p> 	<b>3953200132</b>	L=568  d=21	LPL 2232-L/LB/LK/LS 2624(6x4) LA/LAB/LAK/LAS:2624 (6x4) NG:2226/2232:/S/LS 2626/A/B/AB/AS/AK/K/S 2632/A/AK/AS/K/S
<p><b>0907556</b></p> 	<p><b>0003500213</b>                      0005861433                      0003500305                      0003500505</p>	l=152 p=24 D=65 d=21	
<p><b>0907586</b></p> 	<b>0005861533</b>	D=65	senza perno (without pin)
<p><b>0807611</b></p> 	<p><b>6593501106</b>                      3953500006                      6243500006                      6593503406</p>	L=579  d=21	ACTROS - ATEGO I/II - ECONIC - NG
<p><b>0907330</b></p> 	<p><b>0003500413</b>                      0005861235</p>	l=152 p=24 D=80 d=21	



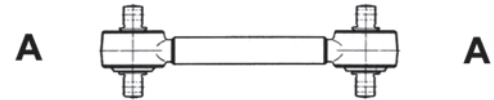
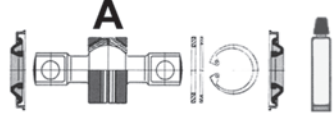
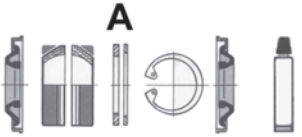
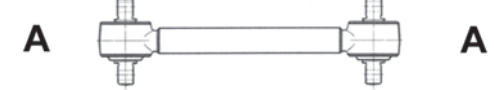

**BARRE DI REAZIONE - TORQUE RODS**

RIF. OCAP OCAP REF.	RIF. ORIG O.E. NUMBER	NOTE REMARKS	MODELLO / DESCRIZIONE MODEL / DESCRIPTION
<p><b>0807616</b></p> 	<p><b>6593501206</b> 6243500106 6593503506 653503506</p>	<p>L=579</p>	<p>NG - SK</p>
<p><b>0907304</b></p> 	<p><b>0003500613</b> 0005861135 0003501805</p>	<p>I=152 p=24 D=70 d=21</p>	
<p><b>0807826</b></p> 	<p><b>3893200732</b></p>	<p>L=582  d=21</p>	<p>1626-1628-1632-1926-1928-1932 2226-2228-2232-2235-2244</p>
<p><b>0907556</b></p> 	<p><b>0003500213</b> 0005861433 0003500305 0003500505</p>	<p>I=152 p=24 D=65 d=21</p>	
<p><b>0907586</b></p> 	<p><b>0005861533</b></p>	<p>D=65</p>	<p>senza perno (without pin)</p>
<p><b>0807615</b></p> 	<p><b>6593500427</b></p>	<p>L=585</p>	<p>LPL 2232-L/LB/LK/LS 2624 (6x4) LA/LAB/LAK/LAS 2624 (6x6) 2626/B/K/S/AK-2628-2632</p>
<p><b>0907304</b></p> 	<p><b>0003500613</b> 0005861135 0003501805</p>	<p>I=152 p=24 D=70 d=21</p>	
<p><b>0807605</b></p> 	<p><b>6593500124</b></p>	<p>L=585</p>	<p>2422-2426-2426B 2429/K/LS/S-2433/K-2435/L/LS/S 2448/LS/S-2472/B--2531-2534K 2535L-2538/K-2544/K/LS/S-2550 3235L-3248-3255</p>

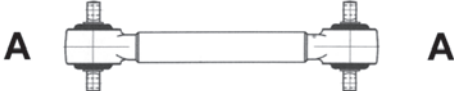
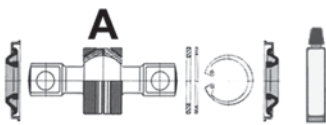

**BARRE DI REAZIONE - TORQUE RODS**

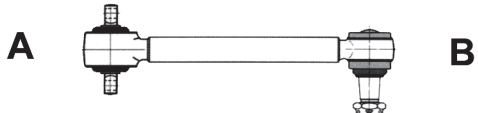
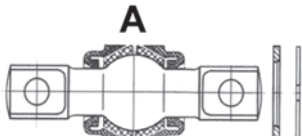
RIF. OCAP OCAP REF.	RIF. ORIG O.E. NUMBER	NOTE REMARKS	MODELLO / DESCRIZIONE MODEL / DESCRIPTION
<b>0907304</b> 	<b>0003500613</b> 0005861135 0003501805	l=152 p=24 D=70 d=21	
<b>0807612</b> 	<b>3953200206</b>	L=585	LPL 2232-L/LB/LK/LS 2624 (6x4) LA/LAB/LAK/LAS 2624 (6x6) 2632/K/S-2636/K
<b>0907556</b> 	<b>0003500213</b> 0005861433 0003500305 0003500505	l=152 p=24 D=65 d=21	
<b>0907586</b> 	<b>0005861533</b>	D=65	senza perno (without pin)
<b>0807643</b> 	<b>6593500106</b> 3953500206 6593502406	L=585  d=21	MK - NG - SK
<b>0907304</b> 	<b>0003500613</b> 0005861135 0003501805	l=152 p=24 D=70 d=21	
<b>0807617</b> 	<b>6593500406</b> 3953500706 6593502706	L=585  d=21	NG - SK
<b>0907304</b> 	<b>0003500613</b> 0005861135 0003501805	l=152 p=24 D=70 d=21	

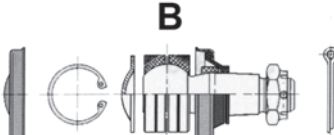

**BARRE DI REAZIONE - TORQUE RODS**

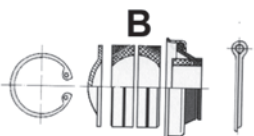
RIF. OCAP OCAP REF.	RIF. ORIG O.E. NUMBER	NOTE REMARKS	MODELLO / DESCRIZIONE MODEL / DESCRIPTION
<p><b>0807586</b></p> 	<p><b>6553500006</b> 6583500206 3933200132 6583500006 653500006</p>	<p>L=585  d=21</p>	<p>NG - SK</p>
<p><b>0907556</b></p> 	<p><b>0003500213</b> 0005861433 0003500305 0003500505</p>	<p>L=152 p=24 D=65 d=21</p>	
<p><b>0907586</b></p> 	<p><b>0005861533</b></p>	<p>D=65</p>	<p>senza perno (without pin)</p>
<p><b>0807638</b></p> 	<p><b>3523500306</b></p>	<p>L=587  d=19</p>	<p>LP 2219 (6x2)</p>
<p><b>0907638</b></p> 	<p><b>0005860132</b></p>	<p>L=152 p=24 D=65 d=19</p>	
<p><b>0907836</b></p> 	<p><b>0005860732</b></p>	<p>D=65</p>	<p>senza perno (without pin)</p>
<p><b>0907601</b></p> 	<p><b>3435860032</b> 0005861633</p>	<p>L=160  K=45 D=65</p>	

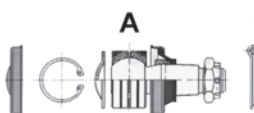
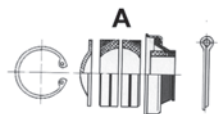
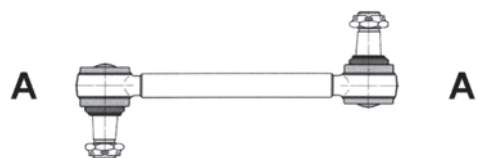
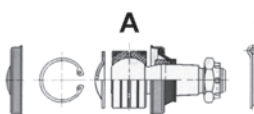
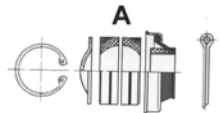
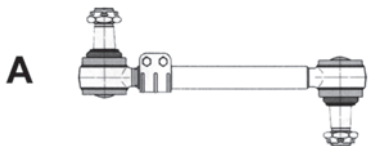



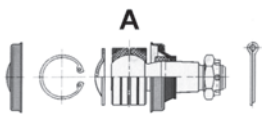
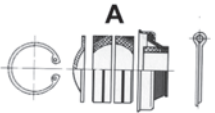
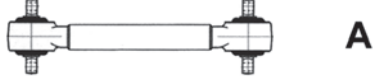
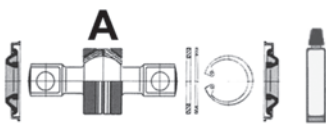

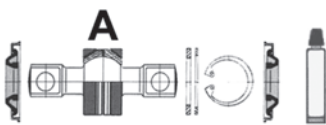
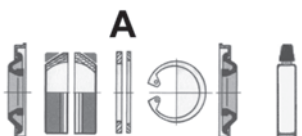

**BARRE DI REAZIONE - TORQUE RODS**

RIF. OCAP OCAP REF.	RIF. ORIG O.E. NUMBER	NOTE REMARKS	MODELLO / DESCRIZIONE MODEL / DESCRIPTION
<p><b>0907602</b></p> 	<p><b>0005860632</b> 0005861733</p>	<p>D=65</p>	<p>senza perno (without pin)</p>
<p><b>0807601</b></p> 	<p><b>3433201632</b> 3433201832 3433201732</p>	<p>L=595</p>	<p>2220-2620-2623-2624</p>
<p><b>0907601</b></p> 	<p><b>3435860032</b> 0005861633</p>	<p>L=160 K=45 D=65</p>	
<p><b>0907602</b></p> 	<p><b>0005860632</b> 0005861733</p>	<p>D=65</p>	<p>senza perno (without pin)</p>
<p><b>0807602</b></p> 	<p><b>3433201732</b> 3433201032 3433201632 3433201832</p>	<p>L=595</p>	<p>1813-1817-1819 2219-2220-2620-2622-2623 2624-2626A/AS/AB/AK 2632A/AK/AS</p>
<p><b>0907601</b></p> 	<p><b>3435860032</b> 0005861633</p>	<p>L=160 K=45 D=65</p>	
<p><b>0907602</b></p> 	<p><b>0005860632</b> 0005861733</p>	<p>D=65</p>	<p>senza perno (without pin)</p>
<p><b>0807637</b></p> 	<p><b>3433201832</b> 3433201632 3433201732</p>	<p>L=595</p>	<p>26.24</p>



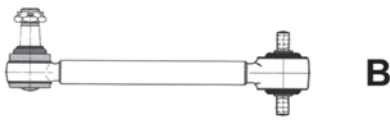

**BARRE DI REAZIONE - TORQUE RODS**

RIF. OCAP OCAP REF.	RIF. ORIG O.E. NUMBER	NOTE REMARKS	MODELLO / DESCRIZIONE MODEL / DESCRIPTION
<p><b>0907601</b></p> 	<p><b>3435860032</b> 0005861633</p>	<p>L=160  K=45 D=65</p>	
<p><b>0907602</b></p> 	<p><b>0005860632</b> 0005861733</p>	<p>D=65</p>	<p>senza perno (without pin)</p>
<p><b>0807556</b></p> 	<p><b>3813500206</b> 3833500006</p>	<p>L=595  d=21</p>	<p>L/LB/LK/LS:2624 LA/LAB/LAK/LAS:2624 LPL:2232 NG: 2226/S/LS-2232/S/LS 2626/B/K/S-2632/K/S</p>
<p><b>0907556</b></p> 	<p><b>0003500213</b> 0005861433 0003500305 0003500505</p>	<p>I=152 p=24 D=65 d=21</p>	
<p><b>0907586</b></p> 	<p><b>0005861533</b></p>	<p>D=65</p>	<p>senza perno (without pin)</p>
<p><b>0807587</b></p> 	<p><b>6553500306</b> 6203500106 6203500006</p>	<p>L=595  d=21</p>	<p>NG - LS/S - SK - MK</p>
<p><b>0907556</b></p> 	<p><b>0003500213</b> 0005861433 0003500305 0003500505</p>	<p>I=152 p=24 D=65 d=21</p>	
<p><b>0907586</b></p> 	<p><b>0005861533</b></p>	<p>D=65</p>	<p>senza perno (without pin)</p>

**BARRE DI REAZIONE - TORQUE RODS**

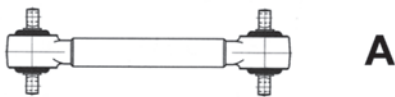
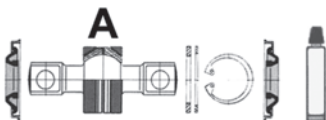

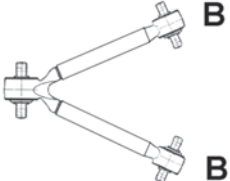

RIF. OCAP OCAP REF.	RIF. ORIG O.E. NUMBER	NOTE REMARKS	MODELLO / DESCRIZIONE MODEL / DESCRIPTION
<p><b>0807614</b></p>  <p><b>0907330</b></p> 	<p><b>3953500606</b></p> <p><b>0003500413</b> 0005861235</p>	<p>L=595</p> <p>d=21</p> <p>l=152 p=24 D=80 d=21</p>	<p>LPL 2232-L/LB/LK/LS 2624 (6x4) LA/LAB/LAB/LAS 2624 (6x6) 2626/B/K/S-2632</p>
<p><b>0807600</b></p>  <p><b>0907304</b></p> 	<p><b>3953500806</b></p> <p><b>0003500613</b> 0005861135 0003501805</p>	<p>L=595</p> <p>d=21</p> <p>l=152 p=24 D=70 d=21</p>	<p>1628-1633-1636-1638-1644-1928 1933-1935-1936-1938-1944-2028-2033 2035-2036-2244-2428-2429-2435-2438</p>
<p><b>0807608</b></p>  <p><b>0907304</b></p> 	<p><b>3953200332</b> 3853500106</p> <p><b>0003500613</b> 0005861135 0003501805</p>	<p>L=610</p> <p>d=21</p> <p>l=152 p=24 D=70 d=21</p>	<p>LP/LPL/LPS/LPLS 608/709/813 LP/LPL 809/913 - LPL 2232 L/LB/LK/LS 2624 (6x4) LA/LAB/LAK/LAS 2624 (6x6) NG:2219/K/KO-2224/B/K/S-2632/K/S</p>
<p><b>0807603</b></p>  <p><b>0907531</b></p>  <p><b>0907304</b></p> 	<p><b>3853500206</b> 3813500306</p> <p><b>0003501013</b></p> <p><b>0003500613</b> 0005861135 0003501805</p>	<p>L=612</p> <p>d=21</p> <p>D=70</p> <p>K=45</p> <p>l=152 p=24 D=70 d=21</p>	<p>NG: 2219/C/CL/L/K/KO 2224/B/K/S</p>

BARRE DI REAZIONE - TORQUE RODS



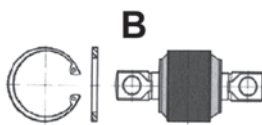
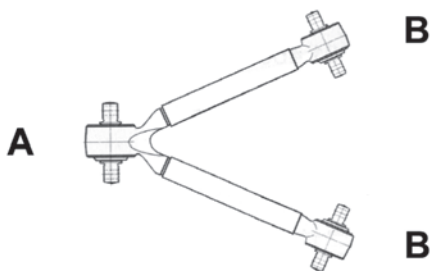
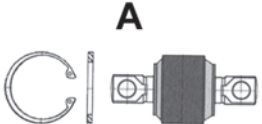
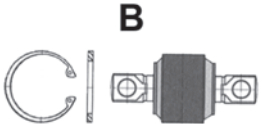

RIF. OCAP OCAP REF.	RIF. ORIG O.E. NUMBER	NOTE REMARKS	MODELLO / DESCRIZIONE MODEL / DESCRIPTION
<p><b>0807827</b></p> 	<b>3893200832</b>	L=614	1813-1817-1819
<p><b>0907556</b></p> 	<p><b>0003500213</b> 0005861433 0003500305 0003500505</p>	<p>l=152 p=24 D=65 d=21</p>	
<p><b>0907586</b></p> 	<b>0005861533</b>	D=65	senza perno (without pin)
<p><b>0807908</b></p> 	<p><b>9483502205</b> 9483502305</p>	L=621,5	ACTROS 1996 > - ACTROS MP2-MP3 - AXOR 2
<p><b>0907908</b></p> 	<b>0003503605</b>	<p>l=152 p=30 d=25</p>	
<p><b>0907909</b></p> 	<b>0003503705</b>	<p>l=130 p=30 d=23</p>	
<p><b>0807599</b></p> 	<p><b>9423500505</b> 9423501205 9423500805 3753500505</p>	L=622	<p>ACTROS Serie U: (1996) 1831/S-1835/S-1840/S 1843/S-1848/S-1853/S-1857/LS AXOR: 2535/LS-2540/LS-2543/LS AXOR 2 - ATEGO MP2 - MP3</p>



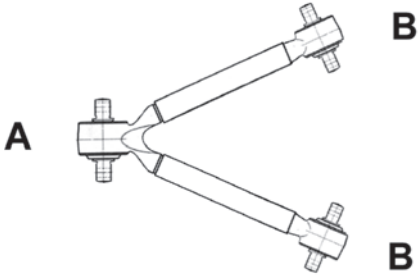

**BARRE DI REAZIONE - TORQUE RODS**

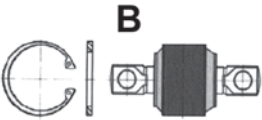
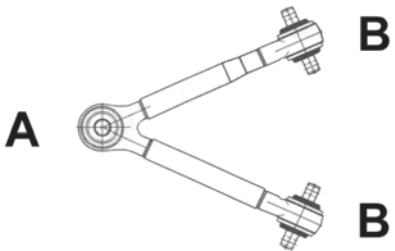
RIF. OCAP OCAP REF.	RIF. ORIG O.E. NUMBER	NOTE REMARKS	MODELLO / DESCRIZIONE MODEL / DESCRIPTION
<b>0907599</b> 	<b>0003502505</b>	l=152 p=24 D=62 d=25	
<b>0807634</b> 	<b>9443500005</b> 9443500305 9473500005 9423501005 9473500105 94373501005 9473500705	L=622  d=25	ACTROS - ACTROS MP2 - MP3 ATEGO - AXOR - AXOR 2 ECONIC: 1823-1828-2628
<b>0907634</b> 	<b>0003502305</b> 0003504405	l=152 p=24 D=70 d=25	
<b>0907609</b> 	<b>0003502205</b> 0003504505	l=130 p=24 D=62 d=25	
<b>0807984</b> 	<b>3753500105</b> 9423500105 9423500705 9423501105 9423501605	L=622 T=46	ACTROS - ACTROS MP2/MP3 ATEGO - AXOR - AXOR 2 ECONIC
<b>0907622</b> 	<b>0003502105</b> 0003504605	l=152  D=75 d=25	
<b>0907984</b> 	<b>0003502005</b> 0003504705	l=130 p=23 D=67 d=23	





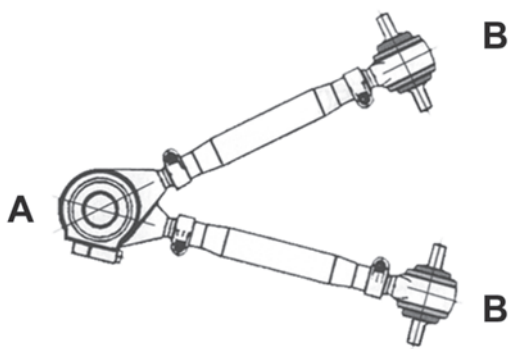
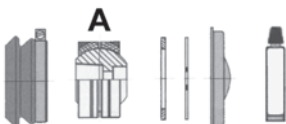

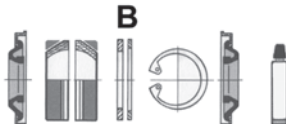
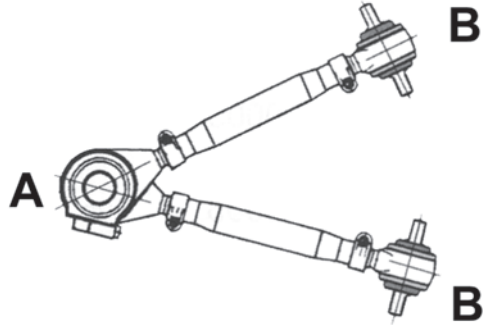
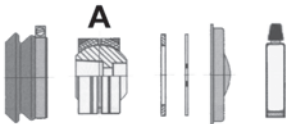
**BARRE DI REAZIONE - TORQUE RODS**

RIF. OCAP OCAP REF.	RIF. ORIG O.E. NUMBER	NOTE REMARKS	MODELLO / DESCRIZIONE MODEL / DESCRIPTION
<p><b>0807774</b></p>  <p><b>0907774</b></p>  <p><b>0907599</b></p> 	<p><b>9483500405</b> 9483503005 9483501105 3753500205 9443500305 9443500505 9473500905 9473500705</p> <p><b>0003502405</b></p> <p><b>0003502505</b></p>	<p>L=622</p> <p>d=25</p> <p>I=152 p=24 D=80 d=25</p> <p>I=152 p=24 D=62 d=25</p>	<p>ACTROS: 3331-3335-3340-3343 3346-3348-3353-3357-4140-4143 4148 - ACTROS MP2 - MP3 ATEGO - AXOR - AXOR 2</p>
<p><b>0807619</b></p>  <p><b>0907925</b></p>  <p><b>0907304</b></p> 	<p><b>6583500105</b> 6583500205 6563500005 6533500205</p> <p><b>0003500613</b> 0005861135 0003501805</p>	<p>L=622</p> <p>d=25</p> <p>I=152 p=24 D=70 d=21</p>	<p>SK</p>

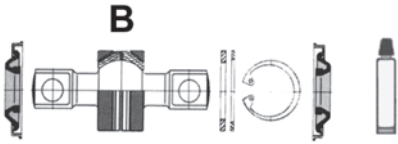
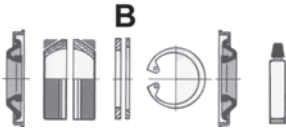

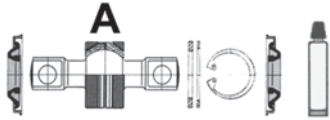

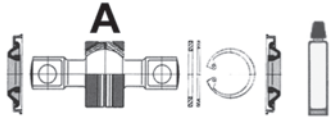

BARRE DI REAZIONE - TORQUE RODS

RIF. OCAP OCAP REF.	RIF. ORIG O.E. NUMBER	NOTE REMARKS	MODELLO / DESCRIZIONE MODEL / DESCRIPTION
<p><b>0807218</b></p> 	<p><b>6553500305</b> 3933505405 3933505505 6533500105 6583500005 6533500005 3833500105 3933505205 3933505305</p>	<p>L=623  d=21</p>	<p>NG - SK</p>
<p><b>0907584</b></p> 	<p><b>0003500405</b> 0003500105 0005861833 0005860135 0005861933</p>	<p>L=62 IK=40  D=80</p>	
<p><b>0907556</b></p> 	<p><b>0003500213</b> 0005861433 0003500305 0003500505</p>	<p>l=152 p=24 D=65 d=21</p>	
<p><b>0907586</b></p> 	<p><b>0005861533</b></p>	<p>D=65</p>	<p>senza perno (without pin)</p>
<p><b>0807867</b></p> 	<p><b>6543500105</b> 6543500005 6543500305</p>	<p>L=623  d=21</p>	<p>MK: 1420/L/LS 1422/L/LS/S-1424/L/LS/S 1426/LS/S-1717/L-1720/L 1722/L-1726/LS/S-1733/LS/S 1820/L-1824/L-1827/LS/L/S 1831/L-1834/L/LS/S-2420/L 2422/L-2426/L-2433/LS/S 2524/L-2527/L-2531/L 2534/L/LS/S</p>
<p><b>0907584</b></p> 	<p><b>0003500405</b> 0003500105 0005861833 0005860135 0005861933</p>	<p>L=62 IK=40  D=80</p>	

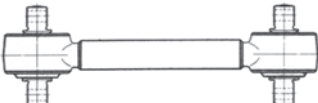

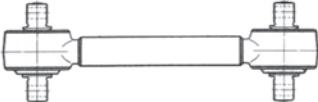
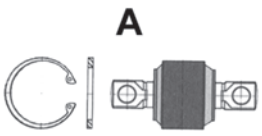



**BARRE DI REAZIONE - TORQUE RODS**

RIF. OCAP OCAP REF.	RIF. ORIG O.E. NUMBER	NOTE REMARKS	MODELLO / DESCRIZIONE MODEL / DESCRIPTION
<p><b>0907556</b></p>  <p><b>0907586</b></p> 	<p><b>0003500213</b> 0005861433 0003500305 0003500505</p> <p><b>0005861533</b></p>	<p>I=152 p=24 D=65 d=21</p> <p>D=65</p>	<p>senza perno (without pin)</p>
<p><b>0807828</b></p>  <p><b>0907556</b></p>  <p><b>0907586</b></p> 	<p><b>3933200232</b></p> <p><b>0003500213</b> 0005861433 0003500305 0003500505</p> <p><b>0005861533</b></p>	<p>L=627</p> <p>d=21</p> <p>I=152 p=24 D=65 d=21</p> <p>D=65</p>	<p>NG:1632-2626-2632</p> <p>senza perno (without pin)</p>
<p><b>0807607</b></p>  <p><b>0907556</b></p>  <p><b>0907586</b></p> 	<p><b>3953201532</b></p> <p><b>0003500213</b> 0005861433 0003500305 0003500505</p> <p><b>0005861533</b></p>	<p>L=628</p> <p>d=21</p> <p>I=152 p=24 D=65 d=21</p> <p>D=65</p>	<p>LPL 2232 L/LB/LK/LS:2624(6x4) LA/LAB/LAK/LAS 2624(6x6) NG:2226/2232:/S/LS 2626/B/K/S-2632/K/S 2636AK/K-3332</p> <p>senza perno (without pin)</p>

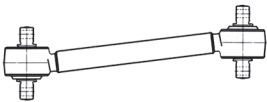

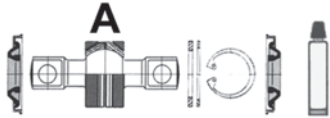

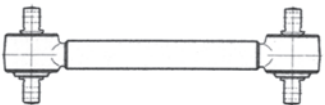
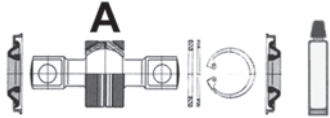
BARRE DI REAZIONE - TORQUE RODS

RIF. OCAP OCAP REF.	RIF. ORIG O.E. NUMBER	NOTE REMARKS	MODELLO / DESCRIZIONE MODEL / DESCRIPTION
<p><b>0807829</b></p> <p><b>A</b>  <b>A</b></p> <p><b>0907330</b></p> <p><b>A</b> </p>	<p><b>6593501306</b> 3953501006 6243500206 6593503606</p> <p><b>0003500413</b> 0005861235</p>	<p>L=629</p> <p>d=21</p> <p>I=152 p=24 D=80 d=21</p>	<p>NG: 2626-2628-2632-2633-2635 2636-3333-3336-3528-3535 SK: 2629-2631-2635-2638-2644 3538</p>
<p><b>0807618</b></p> <p><b>A</b>  <b>A</b></p> <p><b>0907541</b></p> <p><b>A</b> </p>	<p><b>6593501606</b> 3953501306 6243500506 6593501006 6593503306 6593503906</p> <p><b>0003500113</b></p>	<p>L=629</p> <p>d=21</p> <p>I=152 p=24 D=90 d=21</p>	<p>MK - NG: 2632-3250A/AF-3850A SK:4050</p>
<p><b>0807613</b></p> <p><b>A</b>  <b>A</b></p> <p><b>0907304</b></p> <p><b>A</b> </p>	<p><b>6593501406</b> 6243500306 6593503706</p> <p><b>0003500613</b> 0005861135 0003501805</p>	<p>L=629</p> <p>d=21</p> <p>I=152 p=24 D=70 d=21</p>	<p>LPL 2232-L/LB/LK/LS (6x4) LA/LAB/LAK/LAS (6x6)-2626/B/K/S 2626 K(6x4)-2626AK(6x6)-2628AK 2628 AS(6x6)-2636/K 2636/AS/AK (6x6)</p>
<p><b>0807830</b></p> <p><b>A</b>  <b>A</b></p> <p><b>0907330</b></p> <p><b>A</b> </p>	<p><b>6593501506</b> 6243500406 6593503806</p> <p><b>0003500413</b> 0005861235</p>	<p>L=629</p> <p>d=21</p> <p>I=152 p=24 D=80 d=21</p>	<p>NG: 2626-2628-2632-2633-2635 2636-2644-3250-3333-3336-3528 3535-3850 SK: 2629-2631-2635-2638-2644 2648-2650-3534-3535-3538 3550-3553</p>



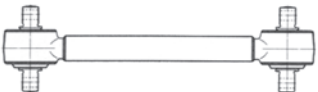
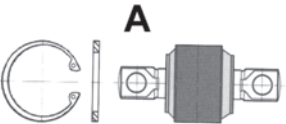
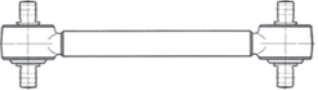
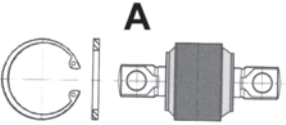

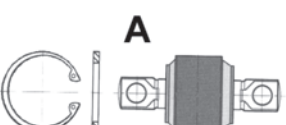

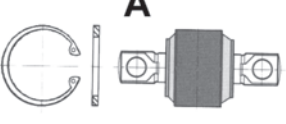
**BARRE DI REAZIONE - TORQUE RODS**

RIF. OCAP OCAP REF.	RIF. ORIG O.E. NUMBER	NOTE REMARKS	MODELLO / DESCRIZIONE MODEL / DESCRIPTION
<p><b>0807831</b></p>  <p><b>0907330</b></p> 	<p><b>3953501206</b> 3953501106 6593500906 6593503206</p> <p><b>0003500413</b> 0005861235</p>	<p>L=635</p> <p>d=21</p> <p>I=152 p=24 D=80 d=21</p>	<p>NG: 2626-2628-2632-2633-2635-2636 3250-3333-3336-3535-3850 SK: 2629-2631-2635-2638-2644-3538</p>
<p><b>0807610</b></p>  <p><b>0907556</b></p>  <p><b>0907586</b></p> 	<p><b>3953201432</b></p> <p><b>0003500213</b> 0005861433 0003500305 0003500505</p> <p><b>0005861533</b></p>	<p>L=638</p> <p>d=21</p> <p>I=152 p=24 D=65 d=21</p> <p>D=65</p>	<p>LPL 2232- L/LB/LK/LS 2624 (6x4) LA/LAB/LAK/LAS 2624 (6x6) NG: 2226K-2626/B/K/S- 2632/K/S</p> <p>senza perno (without pin)</p>
<p><b>0807604</b></p>  <p><b>0907556</b></p>  <p><b>0907586</b></p> 	<p><b>6593502206</b> 6193500206 6593504506</p> <p><b>0003500213</b> 0005861433 0003500305 0003500505</p> <p><b>0005861533</b></p>	<p>L=660</p> <p>d=21</p> <p>I=152 p=24 D=65 d=21</p> <p>D=65</p>	<p>2225-3025 K-3229</p> <p>senza perno (without pin)</p>

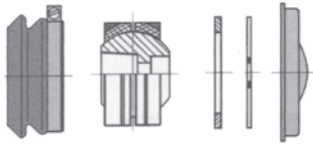
**BARRE DI REAZIONE - TORQUE RODS**

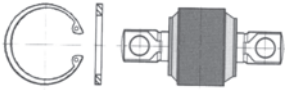



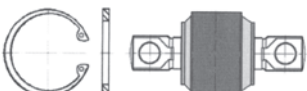
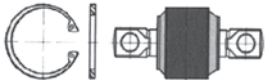

RIF. OCAP OCAP REF.	RIF. ORIG O.E. NUMBER	NOTE REMARKS	MODELLO / DESCRIZIONE MODEL / DESCRIPTION
<p><b>0807671</b></p>  <p><b>A</b> <b>A</b></p> <p><b>0907635</b></p>  <p><b>A</b></p>	<p><b>9413300011</b> 000360098524</p> <p><b>0003301411</b></p>	<p>L=754</p> <p>d=17</p> <p>I=100 p=20 D=55 d=17</p>	<p>ACTROS - ACTROS MP2 - MP3 ATEGO - AXOR 2 ECONIC: 1823-1828-2628</p>
<p><b>0807670</b></p>  <p><b>A</b> <b>A</b></p> <p><b>0907635</b></p>  <p><b>A</b></p>	<p><b>9453300011</b></p> <p><b>0003301411</b></p>	<p>L=755</p> <p>d=17</p> <p>I=100 p=20 D=55 d=17</p>	<p>ACTROS - ACTROS MP2 - MP3 ATEGO: 2523-2528</p>
<p><b>0807636</b></p>  <p><b>A</b> <b>A</b></p> <p><b>0907635</b></p>  <p><b>A</b></p>	<p><b>9413300007</b></p> <p><b>0003301411</b></p>	<p>L=845</p> <p>d=17</p> <p>I=100 p=20 D=55 d=17</p>	<p>ACTROS - MP2 - MP3 ATEGO - ATEGO 2 AXOR 2 - ECONIC</p>
<p><b>0807635</b></p>  <p><b>A</b> <b>A</b></p> <p><b>0907635</b></p>  <p><b>A</b></p>	<p><b>9453300007</b></p> <p><b>0003301411</b></p>	<p>L=850</p> <p>d=17</p> <p>I=100 p=20 D=55 d=17</p>	<p>ACTROS - ACTROS MP2 - MP3 ATEGO - ATEGO 2 ECONIC - AXOR 2</p>

**KIT DI SOSPENSIONE - SUSPENSION KITS**

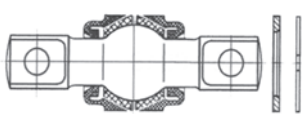

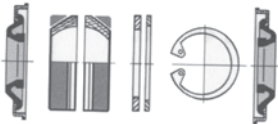



RIF. OCAP OCAP REF.	RIF. ORIG O.E. NUMBER	NOTE REMARKS	MODELLO / DESCRIZIONE MODEL / DESCRIPTION
<b>0907584</b> 	<b>0003500405</b> 0003500105 0005861833 0005860135 0005861933	L=62 IK=40  D=80	NG - MK - SK ACTROS - ATEGO
<b>0907601</b> 	<b>3435860032</b> 0005861633	L=160  K=45 D=65	
<b>0907635</b> 	<b>0003301411</b>	l=100 p=20 D=55 d=17	ACTROS - ACTROS MP2 - MP3 ATEGO - ATEGO 2 ECONIC - AXOR 2
<b>0907201</b> 	<b>0003501505</b>		MK - SK
<b>0907620</b> 	<b>0003500205</b>		MK - NG
<b>0907621</b> 	<b>0005861035</b>		NG
<b>0907609</b> 	<b>0003502205</b> 0003504505	l=130 p=24 D=62 d=25	ACTROS
<b>0907599</b> 	<b>0003502505</b>	l=152 p=24 D=62 d=25	ACTROS Serie U: (1996) 1831/S-1835/S-1840/S 1843/S-1848/S-1853/S-1857/LS AXOR: 2535/LS-2540/LS-2543/LS AXOR 2 - ATEGO MP2 - MP3



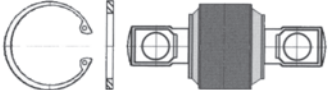



**KIT DI SOSPENSIONE - SUSPENSION KITS**

RIF. OCAP OCAP REF.	RIF. ORIG O.E. NUMBER	NOTE REMARKS	MODELLO / DESCRIZIONE MODEL / DESCRIPTION
<b>0907925</b> 			MK-SK
<b>0907638</b> 	<b>0005860132</b>	l=152 p=24 D=65 d=19	LP
<b>0907602</b> 	<b>0005860632</b> 0005861733	D=65	2220-2620-2623-2624 1813-1817-1819-2219-2220-2620-2622-2623 2624-2626A/AS/AB/AK-2632A/AK/AS
<b>0907836</b> 	<b>0005860732</b>	D=65	LP senza perno (without pin)
<b>0907586</b> 	<b>0005861533</b>	D=65	NG - MK senza perno (without pin)
<b>0907927</b> 	<b>0003300511</b>	p=24 D=67 d=19	CITARO - CONECTO - O 405
<b>0907840</b> 	<b>0003504805</b> 0003503305	l=130 p=30 D=85 d=23	ACTROS - AXOR
<b>0907984</b> 	<b>0003502005</b> 0003504705	l=130 p=23 D=67 d=23	ACTROS - ACTROS MP2/MP3 - ATEGO - AXOR - AXOR 2 - ECONIC

**KIT DI SOSPENSIONE - SUSPENSION KITS**

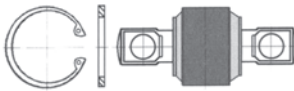
RIF. OCAP OCAP REF.	RIF. ORIG O.E. NUMBER	NOTE REMARKS	MODELLO / DESCRIZIONE MODEL / DESCRIPTION
<b>0907531</b> 	<b>0003501013</b>	D=70  K=45	NG: 2219/C/CL/L/K/KO 2224/B/K/S
<b>0907634</b> 	<b>0003502305</b> 0003504405	l=152 p=24 D=70 d=25	ACTROS
<b>0907547</b> 	<b>0003502705</b>	l=152  D=70 d=21	ACTROS - MP2 - MP3 ATEGO - AXOR - AXOR II
<b>0907330</b> 	<b>0003500413</b> 0005861235	l=152 p=24 D=80 d=21	
<b>0907908</b> 	<b>0003503605</b>	l=152  p=30 d=25	ACTROS 1996 > - ACTROS MP2-MP3 - AXOR 2
<b>0907909</b> 	<b>0003503705</b>	l=130  p=30 d=23	ACTROS 1996 > - ACTROS MP2-MP3 - AXOR 2
<b>0907622</b> 	<b>0003502105</b> 0003504605	l=152  D=75 d=25	ACTROS-ATEGO-AXOR-ECONIC-MK
<b>0907774</b> 	<b>0003502405</b>	l=152 p=24 D=80 d=25	ACTROS: 3331-3335-3340-3343 3346-3348-3353-3357-4140-4143 4148 - ACTROS MP2 - MP3 ATEGO - AXOR - AXOR 2

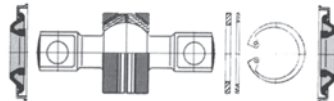

**KIT DI SOSPENSIONE - SUSPENSION KITS**

RIF. OCAP OCAP REF.	RIF. ORIG O.E. NUMBER	NOTE REMARKS	MODELLO / DESCRIZIONE MODEL / DESCRIPTION
<b>0907541</b>  	<b>0003500113</b>	l=152 p=24 D=90 d=21	MK - NG: 2632-3250A/AF-3850A SK:4050
<b>0907623</b>  	<b>0003501905</b> 639340 082751027		MK - NG - SK
<b>0907556</b>  	<b>0003500213</b> 0005861433 0003500305 0003500505	l=152 p=24 D=65 d=21	LK - LN2 NG - SK - LP
<b>0907304</b>  	<b>0003500613</b> 0005861135 0003501805	l=152 p=24 D=70 d=21	ACTROS MP2 - MP3 ECONIC

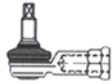
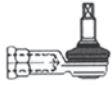

**SNODI SOSPENSIONI - SUSPENSION JOINTS**

RIF. OCAP OCAP REF.	RIF. ORIG O.E. NUMBER	NOTE REMARKS	MODELLO / DESCRIZIONE MODEL / DESCRIPTION
<p><b>0402159</b></p> 	<p><b>6313200228</b> 0003200028 0003200128 6083200028 6083200128 6313200028 6313200128</p>		<p>100 (Furgonato)</p>

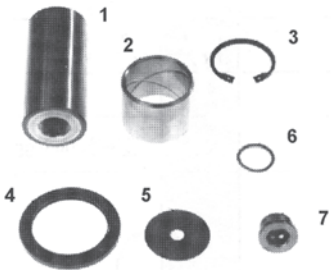
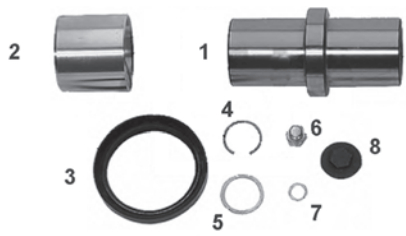

**TESTE COMANDO CAMBIO - GEAR BOX CONTROL BALL JOINTS**

RIF. OCAP OCAP REF.	RIF. ORIG O.E. NUMBER	NOTE REMARKS	MODELLO / DESCRIZIONE MODEL / DESCRIPTION
<b>0287229</b>  	<b>0002686289</b> 0002684689	L=55  M=12x1,75 RH	1418-1424-1624-1626 2064-2219-2223-2224-2232 BM335/336/354/355 BM361/363/366 LPS-NG:1219
<b>0297229</b>  	<b>0002686189</b> 0002684789	L=55  M=12x1,75 LH	1418-1424-1624-1626 2064-2219-2223-2224-2232 BM335/336/354/355 BM361/363/366 LPS-NG:1219
<b>0287646</b>  	<b>0002685589</b> 0002686389	L=55  M=12x1,75 RH	BM 710- BM 717
<b>0187228</b>  	<b>0002684889</b> 0002680189	L=85  M=14 x 1,5 RH	BM: 335-336-354-355-361-363-366 LP: 1624-1418-2219-1424-2223-2224 1626-2064-2232-2223-2224

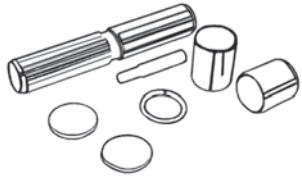
**KIT PERNO FUSO - KING PIN SET**

RIF. OCAP OCAP REF.	RIF. ORIG O.E. NUMBER	NOTE REMARKS	MODELLO / DESCRIZIONE MODEL / DESCRIPTION
<p><b>0927409</b></p> 	<p><b>3463320106</b></p>	<p>L=109  D=50</p>	<p>ACTROS - MP2 - MP3 ATEGO - AXOR 2 - LK - LN2 MK - NG - SK</p>
<p><b>0927410</b></p> 	<p><b>3465860133</b></p>	<p>L=119  D=50/64</p>	<p>ACTROS - MP2 - MP3 ATEGO - LK - LN2 MK - NG - SK</p>
<p><b>0927411</b></p> 	<p><b>6113300019</b></p>	<p>L=136  D=26</p>	<p>T1: 307D - 407D - 408D 409D - 410D - 507D - 510 ASSE / AXLE: BM 730.405/407/447/448 VARIO</p>
<p><b>0927412</b></p> 	<p><b>6013300019</b> 6015865033 6013325306</p>	<p>L=132  D=23</p>	<p>T1: 207D - 208D - 209D - 210D 307D - 309D ASSE / AXLE: BM 730.403/404/445/446</p>
<p><b>0927416</b></p> 	<p><b>3103301219</b> 6683300019</p>	<p>L=154  D=27</p>	<p>406DG L/LK - 407D L/LK - 408DG L 408G L/LF/LK/LKO 409 L/LK/LKO - 410 L/LK 507D - 508DG L - 510 608D L - 609D - 611D O - 613D L - 613D O 614D O - 709D - 709/K - 809D - 811D VARIO</p>

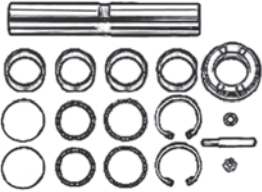
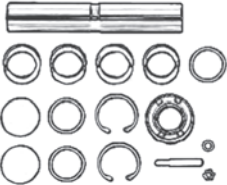
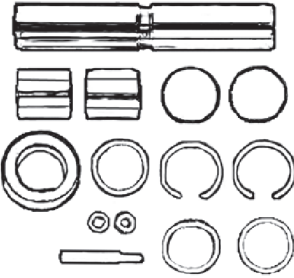
**KIT PERNO FUSO - KING PIN SET**

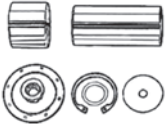
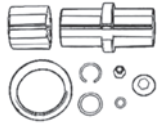
RIF. OCAP OCAP REF.	RIF. ORIG O.E. NUMBER	NOTE REMARKS	MODELLO / DESCRIZIONE MODEL / DESCRIPTION
<b>0927419</b>  	<b>6753300119</b> 6703300119	L=186  D=30	ACTROS-ATEGO ECONIC:1823-1828 LK/LN2-T2/LN1-UNIMOG U VARIO
<b>0927420</b>  	<b>6753300019</b> 6703300219	L=186  D=30	ACTROS-ATEGO ECONIC:1823/1828 LL LK/LN2-T1/TN-T2/LN1 UNIMOG U VARIO
<b>0927432</b>  	<b>3553300319</b> 3555860033	L=219  D=45	1219 K - 1413 /K/KO - 1414 /K 1417/K/KO/C/CK 1419 /F/K/L/S/C/CL 1420/L/LS - 1422/F/L/LS/S 1424/F/K/S - 1425/LS/S 1428 F - 1613/K/KO/L - 1614/K 1617/K/KO/L/S/C/CK/CL/CS 1619 /K/KO/L/S/C - 1620 /L 1622 /K/L/S - 1624 /K/L/LS/S 1625 /K/L/LS/S -1628 L - 1814 2219 6x2/L 6x2 - 2219 6x4 /K/KO 2222 L - 2224 6x2/6x4 /B
<b>0927436</b>  	<b>3913300019</b> 3915860033 3895860033	L=222,5  D=50/51	ASSE ANTERIORE/FRONT AXLE: ACTROS - ATEGO - ATEGO 2 - ECONIC MK - NG - SK
<b>0927437</b>  	<b>3463300019</b> 3465860033	L=109  D=50	ASSE ANTERIORE/FRONT AXLE: ACTROS - ACTROS MP2 - MP3 ATEGO ACTROS - ACTROS MP2 - MP3 ATEGO - AXOR II - LK/LN2 MK - NG - SK
<b>0927438</b>  	<b>3463300119</b> 3465860133	L=119  D=50/64	ASSE ANTERIORE/FRONT AXLE: ACTROS - ACTROS MP2 - MP3 ATEGO - AXOR II - LN/LN2 - SK

**KIT PERNO FUSO - KING PIN SET**

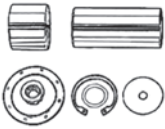
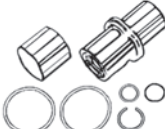

RIF. OCAP OCAP REF.	RIF. ORIG O.E. NUMBER	NOTE REMARKS	MODELLO / DESCRIZIONE MODEL / DESCRIPTION
<b>0927440</b>  	<b>6253300119</b>	L=109  D=55	ASSE ANTERIORE/FRONT AXLE: BM 731.900/924 ACTROS - MP2 - MP3 - ATEGO - AXOR II MK - NG - SK - MP3
<b>0927441</b>  	<b>6253300219</b>	L=126  D=55/60/76	ASSE ANTERIORE/FRONT AXLE: NG - SK ACTROS - ATEGO - AXOR II

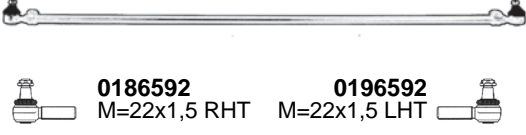

**BARRE ACCOPPIAMENTO - TIE RODS**

RIF. OCAP OCAP REF.	RIF. ORIG O.E. NUMBER	NOTE REMARKS	MODELLO / DESCRIZIONE MODEL / DESCRIPTION
<p><b>0506588</b></p>  <p><b>0186592</b>      <b>0196592</b> M=22x1,5 RHT    M=22x1,5 LHT</p>	<p><b>11200265-0</b></p>	<p>L=1385</p>	<p>ECO T 100 35.08-35.09-35.095</p>





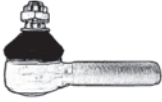
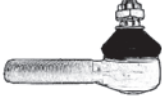

**TIRANTI LONGITUDINALI - DRAG LINKS**

RIF. OCAP OCAP REF.	RIF. ORIG O.E. NUMBER	NOTE REMARKS	MODELLO / DESCRIZIONE MODEL / DESCRIPTION
<p><b>0506591</b></p> 	<p><b>11505036-0</b></p>	<p>L=755</p>	<p>TRADE: 2.8-3.0-100</p>
<p><b>0506590</b></p> 	<p><b>11200454-0</b></p>	<p>L=780</p>	<p>ECO T 100 35.08-35.09-35.095</p>







**TESTE STERZO - TIE RODS END**

RIF. OCAP OCAP REF.	RIF. ORIG O.E. NUMBER	NOTE REMARKS	MODELLO / DESCRIZIONE MODEL / DESCRIPTION
<b>0186592</b>  	<b>11200360-0</b>	L=95  m=14x1,5	L 35.08-L 35.09 ECOT 100.35-ECOT 100.56 TRADE-CABSTAR ATLEON
<b>0196592</b>  	<b>11200361-0</b>	L=95  M=22x1,5 LHT	L 35.08-L 35.09 ECOT 100.35-ECOT 100.56 TRADE-CABSTAR ATLEON





**BARRE ACCOPPIAMENTO - TIE RODS**

RIF. OCAP OCAP REF.	RIF. ORIG O.E. NUMBER	NOTE REMARKS	MODELLO / DESCRIZIONE MODEL / DESCRIPTION
<p><b>0509912</b></p>  <p><b>0186424</b> M=30x1,5 RHT</p>	<p><b>1164684</b></p>	<p>L=825 T=42</p>	-
<p><b>0506699</b></p>  <p><b>0186595</b> M=24x1,5 RHT    <b>0196595</b> M=24x1,5 LHT</p>	<p><b>5000446681</b> 5010224899</p>	<p>L=1310</p>	MIDLINER: M-S
<p><b>0506904</b></p>  <p><b>0186613</b> M=28x1,5 RH    <b>0196613</b> M=28x1,5 LH</p>	<p><b>5010097562</b> 5000350120 5000541224</p>	<p>L=1404</p>	MIDLINER M/S
<p><b>0506595</b></p>  <p><b>0186595</b> M=24x1,5 RHT    <b>0196595</b> M=24x1,5 LHT</p>	<p><b>5000393080</b> 5000393204 5000614223 5010224898</p>	<p>L=1420 T=30</p>	MESSENGER
<p><b>0506697</b></p>  <p><b>0186424</b> M=30x1,5 RHT    <b>0196424</b> M=30x1,5 LHT</p>	<p><b>5000613837</b></p>	<p>L=1440</p>	MIDLINER: M-S
<p><b>0507864</b></p>  <p><b>0182345</b> M=30x1,5 RHT    <b>0192345</b> M=30x1,5 LHT</p>	<p><b>5010566049</b></p>	<p>L=1470</p>	MIDLUM





**BARRE ACCOPPIAMENTO - TIE RODS**

RIF. OCAP OCAP REF.	RIF. ORIG O.E. NUMBER	NOTE REMARKS	MODELLO / DESCRIZIONE MODEL / DESCRIPTION
<p><b>0507865</b></p>  <p><b>0182346</b> M=30x1,5 RHT</p>	<p><b>5010439023</b> 5010291903 5010566062</p>	<p>L=1540</p>	<p>MIDLUM MIDLINER: M-S</p>
<p><b>0506754</b></p>  <p><b>0186598</b>      <b>0196598</b> M=30x1,5 RHT    M=30x1,5 LHT</p>	<p><b>5010308082</b></p>	<p>L=1620</p>	<p>PREMIUM - KERAX</p>
<p><b>0507987</b></p>  <p><b>0186598</b>      <b>0196598</b> M=30x1,5 RHT    M=30x1,5 LHT</p>	<p><b>5010308215</b> 5010566058</p>	<p>L=1650 T=48</p>	<p>KERAX - MAGNUM - MIDLUM - PREMIUM 2</p>
<p><b>0509910</b></p> 	<p><b>7420713859</b> 20713859</p>	<p>L=1657 T=42</p>	<p>KERAX 370-380-410-450-460-500</p>
<p><b>0509911</b></p>  <p><b>0187723</b> M=30x1,5 RHT</p>	<p><b>7422163637</b></p>	<p>L=1686 T=60</p>	<p>C SERIE 250P-280P-320P PREMIUM 2 DISTRIBUTION PREMIUM 2 ROUTE</p>
<p><b>0506695</b></p>  <p><b>0186598</b>      <b>0196598</b> M=30x1,5 RHT    M=30x1,5 LHT</p>	<p><b>5000786902</b> 5010145077 0023123224 0023123230 5001860359</p>	<p>L=1690</p>	<p>MIDLINER: M 140-M 200-M 230- M 250 S 120-S 220 MIDLUM</p>



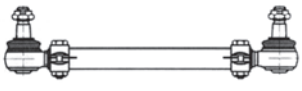

**BARRE ACCOPPIAMENTO - TIE RODS**

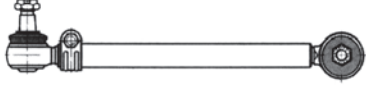
RIF. OCAP OCAP REF.	RIF. ORIG O.E. NUMBER	NOTE REMARKS	MODELLO / DESCRIZIONE MODEL / DESCRIPTION
<p><b>0507855</b></p>  <p><b>0187854</b>      <b>0197854</b> M=30x1,5 RHT    M= 30x1,5 LHT</p>	<p><b>5010566059</b></p>	<p>L=1700</p>	<p>PREMIUM KERAX</p>
<p><b>0507849</b></p>  <p><b>0186598</b>      <b>0196598</b> M=30x1,5 RHT    M=30x1,5 LHT</p>	<p><b>5010439631</b> 5010098467 5010145584</p>	<p>L=1745</p>	<p>KERAX - MAJOR MAXTER - PREMIUM</p>
<p><b>0507856</b></p>  <p><b>0187856</b> M=30x1,5 RHT</p>	<p><b>5010566064</b> 5010439022</p>	<p>L=1720</p>	<p>PREMIUM</p>
<p><b>0507858</b></p>  <p><b>0187856</b> M=30x1,5 RHT</p>	<p><b>5010566063</b> 5010439021</p>	<p>L=1755</p>	<p>PREMIUM - DITRIBUTION - ROUTE MAGNUM - MAGNUM AE - E. TECH KERAX</p>

**TIRANTI LONGITUDINALI - DRAG LINKS**





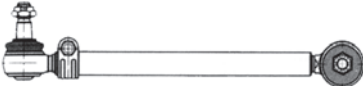

RIF. OCAP OCAP REF.	RIF. ORIG O.E. NUMBER	NOTE REMARKS	MODELLO / DESCRIZIONE MODEL / DESCRIPTION
<p><b>0507884</b></p>  <p><b>0187884</b> M=24x1,5 RH</p> <p><b>0197884</b> M=24x1,5 LH</p>	<b>5010488464</b>	L=540	MASCOTT
<p><b>0506689</b></p>  <p><b>0187891</b> M=38x1,5 RHT</p>	<b>0023123262</b>	L=505	BERLIET GHB 230-260 GLM 280-TLM 280
<p><b>0507202</b></p>  <p><b>0186595</b> M=24x1,5 RHT</p> <p><b>0196595</b> M=24x1,5 LHT</p>	<b>5000395435</b> 5000395296	L=495	B 70 - B 90 MESSENGER B 110.45-120
<p><b>0507741</b></p>  <p><b>0186598</b> M=30x1,5 RH</p> <p><b>0196598</b> M=30x1,5 LH</p>	<b>5430122944</b> 5430119888	L=603	Gamma: G MAXTER KERAX (6x4) - (8x4)
<p><b>0506679</b></p>  <p><b>0186598</b> M=30x1,5 RHT</p>	<b>5010060764</b> 5010557243	L=720	Gamma: AE-EURO 2 MAGNUM AE 420 MAGNUM DXI MAGNUM E.TECH
<p><b>0507740</b></p>  <p><b>0186598</b> M=30x1,5 RH</p>	<b>5010130383</b>	L=725	CBH/CLM (6x6)

TIRANTI LONGITUDINALI - DRAG LINKS





RIF. OCAP OCAP REF.	RIF. ORIG O.E. NUMBER	NOTE REMARKS	MODELLO / DESCRIZIONE MODEL / DESCRIPTION
<p><b>0506688</b></p>  <p><b>0186598</b> M=30x1,5 RHT</p>	<p><b>5010130344</b> 5000932435 5010174787</p>	<p>L=737</p>	<p>AE MAGNUM: AE E. TECH</p>
<p><b>0507253</b></p>  <p><b>0186598</b> M=30x1,5 RHT</p>	<p><b>213123269</b> 213123268</p>	<p>L=807</p>	<p>BERLIET: GLT 190 - CBH 200</p>
<p><b>0506681</b></p>  <p><b>0186598</b> M=30x1,5 RHT</p>	<p><b>5010294287</b></p>	<p>L=809</p>	<p>PREMIUM DISTRIBUTION PREMIUM ROUTE PREMIUM 2 DISTRIBUTION PREMIUM 2 ROUTE Sosp ensioni anteriori meccaniche (Mechanic suspension-front)</p>
<p><b>0506680</b></p>  <p><b>0186598</b> M=30x1,5 RHT</p>	<p><b>5000787472</b> 5010130483</p>	<p>L=825</p>	<p>C 260-300-340</p>
<p><b>0506684</b></p>  <p><b>0186598</b> M=30x1,5 RHT</p>	<p><b>5010294288</b></p>	<p>L=825</p>	<p>PREMIUM DISTRIBUTION PREMIUM ROUTE PREMIUM 2 DISTRIBUTION PREMIUM 2 ROUTE Sosp ensioni anteriori meccaniche (Mechanic suspension-front)</p>
<p><b>0507755</b></p>  <p><b>0186598</b> M=30x1,5 RHT</p>	<p><b>5010064715</b> 5010130382 7485114932</p>	<p>L=830</p>	<p>C CBH - C CLM</p>







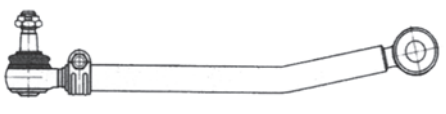

TIRANTI LONGITUDINALI - DRAG LINKS

RIF. OCAP OCAP REF.	RIF. ORIG O.E. NUMBER	NOTE REMARKS	MODELLO / DESCRIZIONE MODEL / DESCRIPTION
<p><b>0507854</b></p>  <p><b>0187854</b> M=30x1,5 RHT</p>	<b>5010294720</b>	L=840	PREMIUM ROUTE
<p><b>0506682</b></p>  <p><b>0186598</b> M=30x1,5 RHT</p>	<b>5010294502</b>	L=847	PREMIUM DISTRIBUTION PREMIUM ROUTE
<p><b>0507677</b></p>  <p><b>0186598</b> M=30x1,5 RHT</p>	<b>5001855163</b> 0023123269 0023123268	L=850	GLR 190-230 GLC 190-230
<p><b>0506685</b></p>  <p><b>0186598</b> M=30x1,5 RHT</p>	<b>5010294289</b>	L=861	PREMIUM DISTRIBUTION PREMIUM ROUTE PREMIUM 2 DISTRIBUTION PREMIUM 2 ROUTE Sospensioni anteriori pneumatiche (Pneumatic suspension front)
<p><b>0506751</b></p>  <p><b>0186598</b> M=30x1,5 RHT</p>	<b>5000785429</b>	L=870	BERLIET GR-GC:231-291 GF:231-291-GRH PGC: 191-231 GRH 235
<p><b>0506683</b></p>  <p><b>0186424</b> M=30x1,5 RHT</p>	<b>5010130393</b>	L=872	MIDLINER M: 150-180-210-250 MIDLINER S: 135-150-180-210 C-G - KERAX - MAGNUM PREMIUM DISTRIBUTION/ROUTE MAXTER MESSENGER MASCOTT





TIRANTI LONGITUDINALI - DRAG LINKS

RIF. OCAP OCAP REF.	RIF. ORIG O.E. NUMBER	NOTE REMARKS	MODELLO / DESCRIZIONE MODEL / DESCRIPTION
<p><b>0506690</b></p>  <p><b>0186424</b> M=30x1,5 RHT</p>	<p><b>5000541230</b> 5000352082 5000352083 5516017400 5516017831</p>	L=880	MIDLINER S: 130-150-170
<p><b>0507862</b></p>  <p><b>0182344</b> M=28x1,5 RHT</p>	<b>5010488165</b>	L=883	MIDLUM
<p><b>0506686</b></p>  <p><b>0186613</b> M=28x1,5 RHT</p>	<p><b>5010130456</b> 5010037602 5010037603 5010037418 5010130446 5010130447 5010163162 5010163163 5010163161</p>	L=885	MIDLINER M: 150-180-210-250 MIDLINER S: 120-135-140-150-160-180-210
<p><b>0507861</b></p>  <p><b>0182344</b> M=28x1,5 RHT</p>	<b>5010488164</b>	L=886	MIDLUM
<p><b>0507985</b></p>  <p><b>0186613</b> M=28x1,5 RHT</p>	<p><b>5010383097</b> 7485114938</p>	L=895 T=40	MIDLINER M: 150-180-210-250 MIDLINER S: 135-140-150-160-180-210
<p><b>0506687</b></p>  <p><b>0186598</b> M=30x1,5 RHT</p>	<p><b>5010229242</b> 5010488052</p>	L=934	KERAX MAXTER G

**TIRANTI LONGITUDINALI - DRAG LINKS**

RIF. OCAP OCAP REF.	RIF. ORIG O.E. NUMBER	NOTE REMARKS	MODELLO / DESCRIZIONE MODEL / DESCRIPTION
<p><b>0507220</b></p>  <p><b>0186424</b> M=30x1,5 RHT</p>	<p><b>5010488146</b></p>	<p>L=940 T=42</p>	<p>MIDLUM</p>
<p><b>0506693</b></p>  <p><b>0186424</b> M=30x1,5 RHT</p>	<p><b>5000932435</b> 5010174787</p>	<p>L=940</p>	<p>MAGNUM AE MAGNUM E-TECH</p>
<p><b>0507988</b></p> 	<p><b>5010488097</b> 5010383529</p>	<p>L=944 T=52</p>	<p>KERAX: 340-370-385-400-420 MAXTER: G 300-340</p>
<p><b>0507863</b></p>  <p><b>0182345</b> M=30x1,5 RHT</p>	<p><b>5010488167</b> 5010305367</p>	<p>L=946</p>	<p>MIDLUM</p>
<p><b>0506676</b></p>  <p><b>0186598</b> M=30x1,5 RHT</p>	<p><b>5010144552</b> 5000725267 5000787304 5010144549 5000787305 5000787306</p>	<p>L=975</p>	<p>MANAGER G: 270-280-300-330-340 MAXTER G: 230-260-280-300-340</p>
<p><b>0507674</b></p>  <p><b>0186598</b> M=30x1,5 RHT</p>	<p><b>5010144554</b> 5000725268</p>	<p>L=975</p>	<p>G G 200/210/230 TI/260/290 G MANAGER (4x2) G MANAGER (6x2) (6x4)</p>

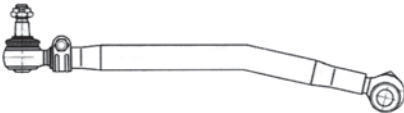





TIRANTI LONGITUDINALI - DRAG LINKS

RIF. OCAP OCAP REF.	RIF. ORIG O.E. NUMBER	NOTE REMARKS	MODELLO / DESCRIZIONE MODEL / DESCRIPTION
<p><b>0506677</b></p>  <p><b>0186598</b> M=30x1,5 RHT</p>	<p><b>5010144556</b> 5000745719 5000791330 5010144551 5010092170 5010092191 5010144557</p>	L=975	<p>MANAGER G MAXTER G</p>
<p><b>0506642</b></p>  <p><b>0186598</b> M=30x1,5 RHT</p>	<p><b>5010130453</b> 0023123247 5000748868 5000874577 5000748784 5010138446 5010138060 0000712758 0000721608 5010138691 5000783889 5000874578 50101030452</p>	L=1012	<p>R 340 Modello unico fino a 05/93 Dopo vedi: 0506678-0506691 RIF.OCAP (Only model to 05/93. After Check For OCAP REF.: 0506678-0506691) MAJOR R</p>
<p><b>0507673</b></p>  <p><b>0186598</b> M=30x1,5 RHT</p>	<p><b>5010130451</b></p>	L=1012	<p>GR/TR 280/305 R 310 (4x2) &gt; 8/84 R310 (6X4) JSQ 8/84 R 310/330/340/365 1984 &gt; R 1993 &gt; MAJOR J</p>
<p><b>0506678</b></p>  <p><b>0186598</b> M=30x1,5 RHT</p>	<p><b>5010239340</b> 5010130739 5010239386</p>	L=1018	<p>R - MAJOR R</p>
<p><b>0507765</b></p>  <p><b>0186598</b> M=30X1,5 RHT</p>	<p><b>5010130710</b></p>	L=1040	<p>R 93&gt; MAJOR R</p>

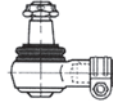
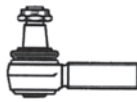
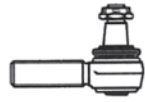

**TIRANTI LONGITUDINALI - DRAG LINKS**

RIF. OCAP OCAP REF.	RIF. ORIG O.E. NUMBER	NOTE REMARKS	MODELLO / DESCRIZIONE MODEL / DESCRIPTION
<p><b>0506691</b></p>  <p><b>0186598</b> M=30x1,5 RHT</p>	<p><b>5010239387</b> 5010130740</p>	<p>L=1040</p>	<p>R: 310-330-340-350-365 370-380-390-420 MAJOR: 340-350-380-385-420</p>





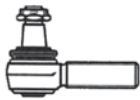
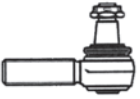
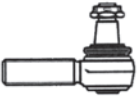

## TESTE STERZO - TIE RODS END

RIF. OCAP OCAP REF.	RIF. ORIG O.E. NUMBER	NOTE REMARKS	MODELLO / DESCRIZIONE MODEL / DESCRIPTION
<b>0287361</b> 	<b>5001849879</b>	L=75  M=26x1,5 RHT	PREMIUM DISTRIBUTION - PREMIUM ROUTE
<b>0287360</b> 	<b>5001849880</b>	L=90  M=26x1,5 RHT	PREMIUM DISTRIBUTION - PREMIUM ROUTE
<b>0186595</b> 	<b>5000814097</b> 5000807554 5001844136 5001860123 0003406252	L=95  M=24x1,5 RHT	B 70 - B 90 MASCOTT - MESSENGER B MIDLINER M - MIDLINER S
<b>0180730</b> 	<b>5001836801</b>	L=95 M22x1,5 RHT	
<b>0196595</b> 	<b>5000814096</b> 5000807553 5001847436 5001860769 5001858756	L=100  M=24x1,5 LHT	B 70 - B 90 MASCOTT - MESSENGER B MIDLINER M - MIDLINER S
<b>0287291</b> 	<b>7485114029</b>		PREMIUM ROUTE PREMIUM 2 DISTRIBUTION
<b>0187884</b> 	<b>5001860770</b>	L=100  M=24x1,5 RHT	MASCOTT
<b>0197884</b> 	<b>5001860769</b>	L=100  M=24x1,5 LHT	MASCOTT
<b>0186613</b> 	<b>5000823987</b> 500559335 5001825687 0003406242	L=105  M=28x1,5 RHT	MIDLINER M - MIDLINER S MESSENGER B MIDLUM

**TESTE STERZO - TIE RODS END**

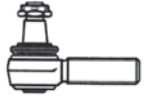
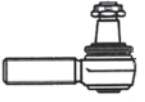
RIF. OCAP OCAP REF.	RIF. ORIG O.E. NUMBER	NOTE REMARKS	MODELLO / DESCRIZIONE MODEL / DESCRIPTION
<b>0196613</b> 	<b>5000823997</b> 5000823947 500559336	L=105  M=28x1,5 LHT	MIDLINER M - MIDLINER S MESSENGER B MIDLUM
<b>0182344</b> 	-	L=110  M=28x1,5 RHT	MIDLUM
<b>0182345</b> 	-	L=115  M=30x1,5 RHT	MIDLUM
<b>0192345</b> 	-	L=115  M=30x1,5 LHT	MIDLUM
<b>0186424</b> 	<b>5000295214</b> 0003406212 0003406242 0003406253 5000242159 5000559335 5000812483 5001831473 7701016946 5001832582 5000823987	L=115  M=30x1,5 RHT	MIDLINER M: 140-210-230-250 MIDLINER S: 120-150-170 MIDLUM MAGNUM
<b>0196424</b> 	<b>5000295215</b> 0003406218 0003406213 5001850550 5001852263 5001834533	L=115  M=30x1,5 LHT	MIDLINER M: 140-210-230-250 MIDLINER S: 120-150-170 MIDLUM MAGNUM

TESTE STERZO - TIE RODS END

RIF. OCAP OCAP REF.	RIF. ORIG O.E. NUMBER	NOTE REMARKS	MODELLO / DESCRIZIONE MODEL / DESCRIPTION
<b>0186598</b> 	<b>5000242479</b> 5000288360 0003401169 0003406236 0003406251 0003406254 0003406260 0003406261 5000590236 5000804824 5001836298 7701011412 5010832582 5000275496 5000240688 5000242485 5000253852 5000819349 5001858773	L=120  M=30x1,5 RHT	SERIE C - SERIE R MAGNUM AE / E. TECH KERAX - MAJOR - MANAGER MAXTER - MIDLINER PREMIUM DISTRIBUTION - ROUTE
<b>0196598</b> 	<b>5000242478</b> 5000288361 0003401170 5010832583 5001836297 5001832581 5001858774	L=120  M=30x1,5 LHT	SERIE C - SERIE R MAGNUM AE / E. TECH KERAX - MAJOR - MANAGER MAXTER - MIDLINER PREMIUM DISTRIBUTION - ROUTE
<b>0187854</b> 	-	L=120  M=30x1,5 RHT	PREMIUM
<b>0197854</b> 	-	L=120  M=30x1,5 LHT	PREMIUM
<b>0186599</b> 	<b>0003401207</b> 5001831481 5001832580	L=120  M=38x1,5 RHT	MANAGER MAXTER MIDLINER
<b>0196599</b> 	<b>0003401206</b> 5001832579	L=120  M=38x1,5 LHT	MANAGER MAXTER MIDLINER
<b>0187903</b> 	<b>5001867774</b> 5001866165	L=120  M=32x1,5 RHT	KERAX MAGNUM DXi PREMIUM 2







**TESTE STERZO - TIE RODS END**

RIF. OCAP OCAP REF.	RIF. ORIG O.E. NUMBER	NOTE REMARKS	MODELLO / DESCRIZIONE MODEL / DESCRIPTION
<b>0187146</b> 	<b>5000808458</b> 7701002911	L=120  M=30x1,5 RHT	
<b>0187856</b> 	-	L=130  M=30x1,5 RHT	PREMIUM
<b>0182346</b> 	-	L=130  M=30x1,5 RHT	MIDLUM
<b>0287892</b> 	<b>5000288364</b>	L=130  M=48x1,5 RHT	R R 340.16/.17/.18/.22/.24/.26 R R 350.17/.18/.24/.26 MAJOR R G G 260/290/320
<b>0297892</b> 	<b>5000816456</b> 5000288365	L=130  M=48x1,5 LHT	R R 340.16/.17/.18/.22/.24/.26 R R 350.17/.18/.24/.26 MAJOR R G G 260/290/320
<b>0287752</b> 	<b>5000803464</b> 634300120 11100521	L=140  M=38x1,5 RHT	
<b>0297752</b> 	<b>5000803465</b> 634300130 11100492	L=140  M=38x1,5 LHT	
<b>0187723</b> 	<b>5001852452</b> 5001858763 50 01 852 452 50 01 858 763	L=150  M=30x1,5 RHT	C - MAGNUM - PREMIUM 2 PREMIUM DISTRIBUTION - PREMIUM ROUTE



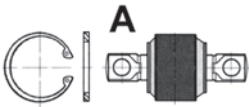
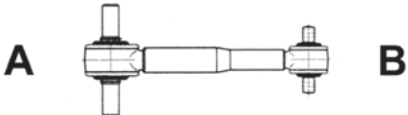
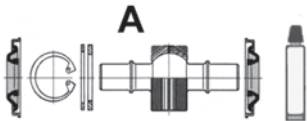

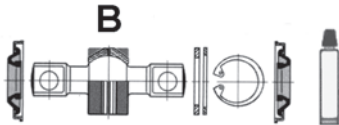

**TESTE STERZO - TIE RODS END**

RIF. OCAP OCAP REF.	RIF. ORIG O.E. NUMBER	NOTE REMARKS	MODELLO / DESCRIZIONE MODEL / DESCRIPTION
<b>0287753</b> 	<b>5000297668</b> 0003401151 0003401203	L=155 M=38x1,5 RHT	
<b>0297753</b> 	<b>5000297669</b> 0003401152 0003401202	L=155 M=38x1,5 RHT	
<b>0197756</b> 	<b>5000297581</b>	L=157 M=30x1,5 LHT	
<b>0187900</b> 	<b>5000297580</b>	L=157 M=30x1,5 RHT	PREMIUM 2
<b>0287350</b> 	<b>5000803460</b>	L=167  M=52x1,5 RH	G 170/210/230/260/290 GC 231/291 GF 151D TF 231D PGC 191/231
<b>0297350</b> 	<b>5000803459</b>	L=167  M=52x1,5 LH	G 170/210/230/260/290 GC 231/291 GF 151D TF 231D PGC 191/231
<b>0286641</b> 	<b>5000288362</b>	L=170  M=52x1,5 RHT	R R 340.17/.18/.24/.26 R R 350.17/.18/.24/.26 MAJOR R
<b>0296641</b> 	<b>5000288363</b>	L=170  M=52x1,5 LHT	R R 340.17/.18/.24/.26 R R 350.17/.18/.24/.26 MAJOR R

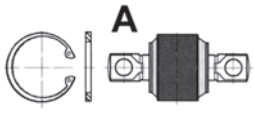

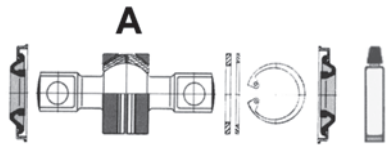
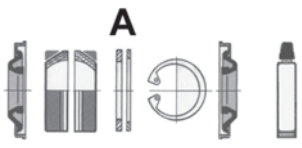

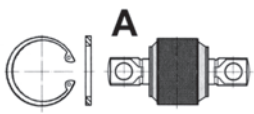

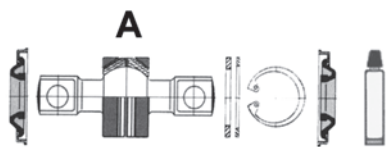
**BARRE DI REAZIONE - TORQUE RODS**

RIF. OCAP OCAP REF.	RIF. ORIG O.E. NUMBER	NOTE REMARKS	MODELLO / DESCRIZIONE MODEL / DESCRIPTION
<p><b>0807752</b></p> 	<b>5010005937</b>	L=480  d=17	R312
<p><b>0907749</b></p> 	<b>5000819365</b> 5010104365	l=122 p=24 D=62 d=17	
<p><b>0807745</b></p> 	<b>0023123251</b>	L=490  d=19	GBH260/280...1979 ME/ML/MD/MK 10 MD/MK 05
<p><b>0907745</b></p> 	-	L=268  P=45 D=80	-
<p><b>0907746</b></p> 	-	D=80	
<p><b>0907747</b></p> 	-	l=145 p=30 D=65 d=19	
<p><b>0907748</b></p> 	-	D=65	senza perno (without pin)
<p><b>0807749</b></p> 	<b>5010207771</b>	L=490  d=17	TRACER



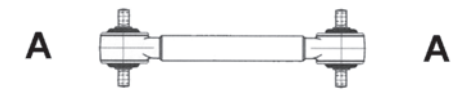
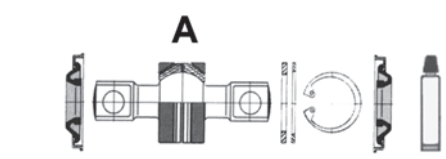
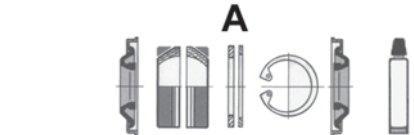

**BARRE DI REAZIONE - TORQUE RODS**

RIF. OCAP OCAP REF.	RIF. ORIG O.E. NUMBER	NOTE REMARKS	MODELLO / DESCRIZIONE MODEL / DESCRIPTION
<p><b>0907749</b></p> 	<p><b>5000819365</b> 5010104365</p>	<p>L=122 p=24 D=62 d=17</p>	
<p><b>0807675</b></p> 	<p><b>0023123275</b></p>	<p>L=535  d=19</p>	<p>GRH/PRH/TRH</p>
<p><b>0907252</b></p> 	<p><b>5010014345</b></p>	<p>L=145  D=65 d=19</p>	
<p><b>0907595</b></p> 	<p><b>5000819413</b></p>	<p>L=145  p=30 d=19</p>	<p>senza perno (without pin)</p>
<p><b>0807753</b></p> 	<p><b>5010207726</b> 5000869572 5010013398</p>	<p>L=550  d=17</p>	<p>FR1.....1989</p>
<p><b>0907749</b></p> 	<p><b>5000819365</b> 5010104365</p>	<p>L=122 p=24 D=62 d=17</p>	
<p><b>0807674</b></p> 	<p><b>5010389262</b></p>	<p>L=574 T=50</p>	<p>KERAX 260-270-300-320-340-370-385 KERAX 400-410-420-450-460-500</p>
<p><b>0907219</b></p> 	<p><b>5001842337</b></p>	<p>L=152  D=90 d=21</p>	

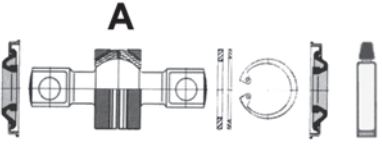
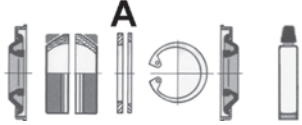

BARRE DI REAZIONE - TORQUE RODS

RIF. OCAP OCAP REF.	RIF. ORIG O.E. NUMBER	NOTE REMARKS	MODELLO / DESCRIZIONE MODEL / DESCRIPTION
<p><b>0807551</b></p> 	<p><b>5000810038</b> 5000027957</p>	<p>L=565</p> <p>d=19</p>	<p>—</p>
<p><b>0907259</b></p> 	<p><b>5001842823</b></p>	<p>l=130</p> <p>p=30</p> <p>D=70</p> <p>d=19</p>	
<p><b>0807678</b></p> 	<p><b>5010268035</b></p>	<p>L=575</p> <p>T=50</p>	<p>C CBH 320.24-320.26-320.34-385.24</p> <p>C CBH 385.26-385.34</p> <p>C CLM 320.25-385.22-385.25</p>
<p><b>0907678</b></p> 	<p><b>5000802123</b> 5001831526</p>	<p>l=145</p> <p>p=30</p> <p>D=85</p> <p>d=19</p>	
<p><b>0807252</b></p> 	<p><b>0023123253</b> 5010064641 5010094838 5010094941 5000783574 5000750976 5001850530 5000787496</p>	<p>L=575</p> <p>d=19</p>	<p>C 300- CBH 320-385- CLM 320-385</p> <p>G 260-290 - KERAX 300-340-385-400</p> <p>MAGNUM AE - MAGNUM E.TECH</p> <p>MAJOR R - MANAGER G</p> <p>R: 310-330-340-350-365-370-380</p> <p>390-420</p>
<p><b>0907252</b></p> 	<p><b>5010014345</b></p>	<p>l=145</p> <p>D=65</p> <p>d=19</p>	
<p><b>0907595</b></p> 	<p><b>5000819413</b></p>	<p>l=145</p> <p>p=30</p> <p>d=19</p>	<p>senza perno (without pin)</p>
<p><b>0807676</b></p> 	<p><b>5010094839</b></p>	<p>L=575</p> <p>d=21</p>	<p>MAXTER G 300 - G 340</p> <p>KERAX - PREMIUM</p>





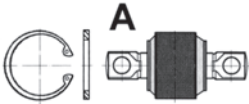
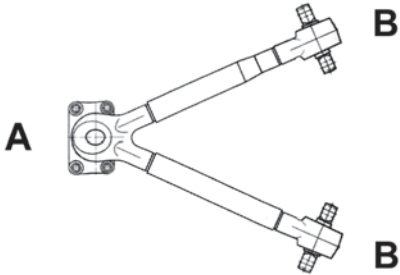
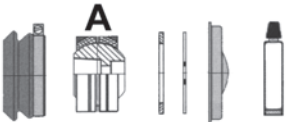
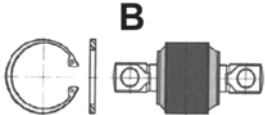

**BARRE DI REAZIONE - TORQUE RODS**

RIF. OCAP OCAP REF.	RIF. ORIG O.E. NUMBER	NOTE REMARKS	MODELLO / DESCRIZIONE MODEL / DESCRIPTION
<p><b>0907676</b></p> <p><b>A</b></p> 	<b>5001823280</b>	<p>l=152</p> <p>d=21</p>	
<p><b>0907677</b></p> <p><b>A</b></p> 	<b>5001823279</b>		Senza perno (without pin)
<p><b>0807219</b></p> <p><b>A</b></p> 	<p><b>5010094840</b> 5010467915</p>	L=575	<p>MAXTER G: 300-340 (6x4) (8x4)</p> <p>KERAX: 300-340-385.33 (6x4)</p> <p>385.40 (8x4)-400</p>
<p><b>0907219</b></p> <p><b>A</b></p> 	<b>5001842337</b>	<p>l=152</p> <p>D=90</p> <p>d=21</p>	
<p><b>0907739</b></p> <p><b>A</b></p> 	<b>5001842337 *</b>		senza perno (without pin)
<p><b>0807913</b></p> <p><b>A</b></p> 	<b>7420741703</b>	L=668	<p>KERAX: 370 - 410 - 450</p> <p>PREMIUM 2 LANDER</p>
<p><b>0907913</b></p> <p><b>A</b></p> 	<b>7420741710</b>	D=72	

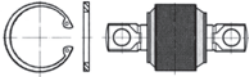
**BARRE DI REAZIONE - TORQUE RODS**

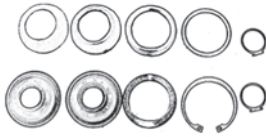





RIF. OCAP OCAP REF.	RIF. ORIG O.E. NUMBER	NOTE REMARKS	MODELLO / DESCRIZIONE MODEL / DESCRIPTION
<p><b>0907919</b></p> 	<b>7420547286</b>	D=75	
<p><b>0807756</b></p> 	<p><b>5010207727</b> 5000869573 5010013397</p>	L=692  d=17	FR1 - > 1989
<p><b>0907749</b></p> 	<p><b>5000819365</b> 5010104365</p>	l=122 p=24 D=62 d=17	
<p><b>0807762</b></p> 	<p><b>7420829503</b> 7421295227</p>	L=671 T=58  d=21	KERAX
<p><b>0907762</b></p> 	<b>3090712</b>		
<p><b>0907763</b></p> 	<p><b>7420840815</b> 3093630 3093631</p>	l=130 p=30 D=85 d=21/26	

**KIT DI SOSPENSIONE - SUSPENSION KITS**

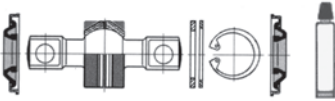

RIF. OCAP OCAP REF.	RIF. ORIG O.E. NUMBER	NOTE REMARKS	MODELLO / DESCRIZIONE MODEL / DESCRIPTION
<p><b>0907749</b></p> 	<p><b>5000819365</b> 5010104365</p>	<p>l=122 p=24 D=62 d=17</p>	<p>R312 - MIDLINER M-S</p>
<p><b>0907746</b></p> 	-	<p>D=80</p>	<p>GBH260/280...1979 ME/ML/MD/MK 10 MD/MK 05 - senza perno (without pin)</p>
<p><b>0907216</b></p> 	<p><b>7701011267</b></p>	<p>l=130 p=30 D=65 d=19</p>	
<p><b>0907595</b></p> 	<p><b>5000819413</b></p>	<p>l=145  p=30 d=19</p>	
<p><b>0907913</b></p> 	<p><b>7420741710</b></p>	<p>D=72</p>	<p>KERAX: 370 - 410 - 450 PREMIUM 2 - PREMIUM DISTRIBUTION - PREMIUM ROUTE</p>
<p><b>0907919</b></p> 	<p><b>7420547286</b></p>	<p>D=75</p>	<p>KERAX: 370 - 410 - 450 PREMIUM 2 - PREMIUM DISTRIBUTION - PREMIUM ROUTE</p>
<p><b>0907259</b></p> 	<p><b>5001842823</b></p>	<p>l=130 p=30 D=70 d=19</p>	
<p><b>0907252</b></p> 	<p><b>5010014345</b></p>	<p>l=145  D=65 d=19</p>	<p>C 300- CBH 320-385- CLM 320-385 G 260-290 - KERAX 300-340-385-400 MAGNUM AE - MAGNUM E.TECH MAJOR R - MANAGER G R: 310-330-340-350-365-370-380 390-420</p>

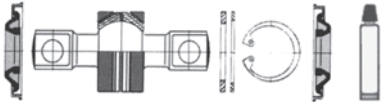

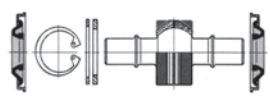

**KIT DI SOSPENSIONE - SUSPENSION KITS**

RIF. OCAP OCAP REF.	RIF. ORIG O.E. NUMBER	NOTE REMARKS	MODELLO / DESCRIZIONE MODEL / DESCRIPTION
<b>0907406</b> 	<b>5001014520</b>	D=65	TRACER
<b>0907678</b> 	<b>5000802123</b> 5001831526	l=145 p=30 D=85 d=19	C CBH 320.24-320.26-320.34-385.24 C CBH 385.26-385.34 C CLM 320.25-385.22-385.25
<b>0907747</b> 	-	l=145 p=30 D=65 d=19	GBH260/280...1979 ME/ML/MD/MK 10 MD/MK 05
<b>0907748</b> 	-	D=65	GBH260/280...1979 ME/ML/MD/MK 10 MD/MK 05 - senza perno (without pin)
<b>0907219</b> 	<b>5001842337</b>	l=152  D=90 d=21	KERAX 300-320-340-370-385-400-420
<b>0907676</b> 	<b>5001823280</b>	l=152  d=21	KERAX - MAXTER
<b>0907677</b> 	<b>5001823279</b>		KERAX - MAXTER

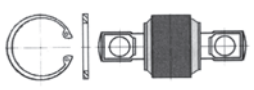

**KIT DI SOSPENSIONE - SUSPENSION KITS**

RIF. OCAP OCAP REF.	RIF. ORIG O.E. NUMBER	NOTE REMARKS	MODELLO / DESCRIZIONE MODEL / DESCRIPTION
<b>0907739</b> 	<b>5001842337 *</b>		MAXTER G: 300-340 (6x4) (8x4) KERAX: 300-340-385.33 (6x4) 385.40 (8x4)-400
<b>0907745</b> 	-	L=268  P=45 D=80	GBH260/280...1979 ME/ML/MD/MK 10 MD/MK 05
<b>0907762</b> 	<b>3090712</b>		KERAX
<b>0907763</b> 	<b>7420840815</b> 3093630 3093631	l=130 p=30 D=85 d=21/26	KERAX

**STABILIZZATORI - STABILIZERS**

RIF. OCAP OCAP REF.	RIF. ORIG O.E. NUMBER	NOTE REMARKS	MODELLO / DESCRIZIONE MODEL / DESCRIPTION
<b>0587991</b> 	<b>5010253256</b>	L=280 T=28	MIDLINER M-S - MIDLUM
<b>0597991</b> 	<b>5010253255</b> 5010238594	L=280 T=28	MIDLINER M-S - MIDLUM
<b>0587990</b> 	<b>5000450713</b>	L=335 T=28	MIDLINER M-S - MIDLUM
<b>0597990</b> 	<b>5000450714</b>	L=335 T=28	MIDLINER M-S - MIDLUM

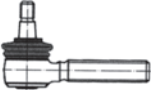
**TESTE COMANDO CAMBIO - GEAR BOX CONTROL BALL JOINTS**

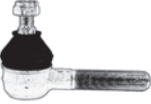
RIF. OCAP OCAP REF.	RIF. ORIG O.E. NUMBER	NOTE REMARKS	MODELLO / DESCRIZIONE MODEL / DESCRIPTION
<p><b>0187228</b></p> 	<p><b>5010245591</b> 5010144543 0023162046 5000516214 5000807536</p>	<p>L=85  M=14 x 1,5 RH</p>	<p>KERAX - MAGNUM AE MIDLUM - MAJOR R PREMIUM DISTRIBUTION PREMIUM 2 DISTRIBUTION PREMIUM ROUTE - PREMIUM 2 ROUTE</p>
<p><b>0287229</b></p> 	<p><b>5010129530</b></p>	<p>L=55  M=12x1,75 RH</p>	
<p><b>0297229</b></p> 	<p><b>5001000134</b></p>	<p>L=55  M=12x1,75 LH</p>	
<p><b>0187346</b></p> 		<p>L=93  M=16 x 1,5 RH</p>	

**KIT PERNO FUSO - KING PIN SET**

RIF. OCAP OCAP REF.	RIF. ORIG O.E. NUMBER	NOTE REMARKS	MODELLO / DESCRIZIONE MODEL / DESCRIPTION
<p><b>0927443</b></p>	<p><b>5000794320</b>                      5005010016 (1)                      5003090091 (2)                      5003066054 (3)                      5000737896 (4)                      5000786411 (5)                      5010056288 (6)                      7703055013 (7)                      5003032162 (8)                      5000737903 (9)                      5000737897 (10)                      0851127900 (11)</p>	<p>L=280  D=46</p>	<p>C 260/C 290                      ASSALE/AXLE:                      E6AC &gt; 02/1987                      E6A71 02/1986 &gt; 02/1987                      C 210/210.19 - CLR 220                      ASSALE/AXLE:                      E6A4C &gt; 02/1985                      E6A711 01/1986 &gt;                      CBH 280/340/350/380                      ASSALE/AXLE:                      E6A511 &gt; 02/1987                      CLR 190/230 - GLC 190                      ASSALE/AXLE:                      E6A411 02/1982 &gt; 02/1985                      GR 191/231                      ASSALE/AXLE:                      E6A411 &gt; 02/1982                      R 310/370/390/420                      ASSALE/AXLE:                      E6A21</p>
<p><b>0927444</b></p>	<p><b>5000793849</b>                      5000737796 (1)                      5010056928 (2)                      7703066036 (3)                      5010056390 (4)                      - (5)                      5010067401 (6)                      5010056288 (7)                      - (8)                      - (9)                      5000737903 (10)                      5000737797 (11)                      - (12)</p>	<p>L=280  D=46</p>	<p>C 260/C 290                      ASSALE/AXLE:                      E6AC 03/1987 &gt;                      E6A71 03/1987 &gt;                      E6A4D 03/1984 &gt;                      C 210/ 210.19 - CLR 220                      ASSALE/AXLE:                      E6A40 &gt;03/1987                      E6A711 02/1986 &gt;                      CLM 320/385 - CBH320/385                      ASSALE/AXLE:                      E6A511 - E6B811                      CBH 280/340/350/380                      ASSALE/AXLE:                      E6A511 03/1987 &gt; 09/1991                      E6A811 03/1987 &gt; 10/1991                      E6B811 10/1991 &gt;                      R310/330/340/365/RI375                      A</p>



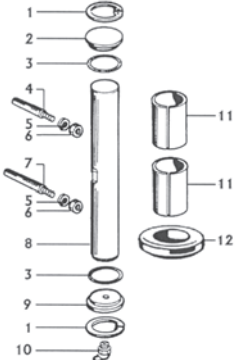
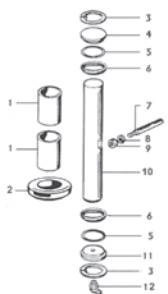
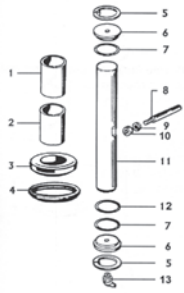
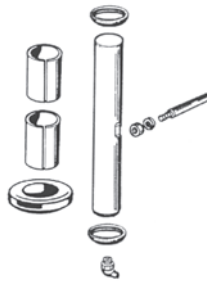

**KIT PERNO FUSO - KING PIN SET**

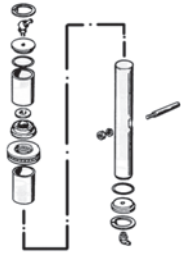
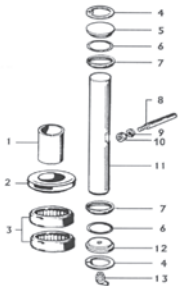
RIF. OCAP OCAP REF.	RIF. ORIG O.E. NUMBER	NOTE REMARKS	MODELLO / DESCRIZIONE MODEL / DESCRIPTION
<p><b>0927445</b></p> 	<p><b>5000794319</b>                      - (1)                      5000761303 (2)                      - (3)                      0022225011 (4)                      - (5)                      - (6)                      - (7)                      5000737530 (8)                      5010056114 (9)                      - (10)                      0000189901 (11)                      5010056925 (12)</p>	<p>L=235  D=40</p>	<p>GLR 190/230 - GLC 190                      ASSALE/AXLE:                      E5A421 12/1979 &gt;                      G 260/G 290                      ASSALE/AXLE:                      E5A4C                      CON TAMBURO FRENO 16 "                      WITH BRAKE CYL. 16"                      E5A4C 02/1985 &gt; 02/1986                      E5AC &gt; 03/1987                      E5A821 02/1985 &gt; 02/1986                      E5A4D &gt; 03/1986                      E5A921 09/1984 &gt; 03/1987                      PR 100.2/E 100.2                      ASSALE/AXLE:                      TRAIN R 16 A                      MAXTER</p>
<p><b>0927446</b></p> 	<p><b>5000793828</b>                      5010056582 (1)                      5010056925 (2)                      - (3)                      5010056465 (4)                      5003086096 (5)                      5010067402 (6)                      5010056288 (7)                      5003057046 (8)                      5003032162 (9)                      5010056583 (10)                      5010056466 (11)                      5005097001 (12)</p>	<p>L=240  D=40</p>	<p>C 230/280/300/340TI/CCH300                      G 170                      G 210/230                      G 200/210/230 TI                      G 220/270 BOM                      G 230/270 SP                      G 260/290                      G 320                      G 340 TI TR 18 T                      PR 100-2                      PR 180-2                      M 140/160/200/230 G.B.</p>
<p><b>0907263</b></p> 	<p><b>5000336305</b></p>	<p>L=178  D=35</p>	<p>JE 13/15                      JP 11/13                      JR 19/21                      JX 19/21                      M / S 4x4                      ME 160/180/210                      SE 160/180/210                      CE 160/180/210                      PS 150/160                      S 130/150 TI / 170 (VF6JP)                      S 170 (FAB=SH)</p>
<p><b>0927447</b></p> 	<p><b>5000794318</b></p>	<p>L=300  D=46</p>	<p>GR 191/232/305/350                      GBH 260/280                      GLR 190/230                      TBH 280 - TLM 280                      TR 305/350                      GLM 280                      G 45                      R 310                      PX 30</p>

**KIT PERNO FUSO - KING PIN SET**

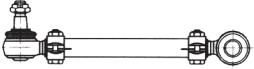
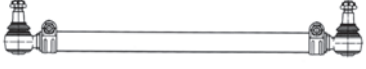
RIF. OCAP OCAP REF.	RIF. ORIG O.E. NUMBER	NOTE REMARKS	MODELLO / DESCRIZIONE MODEL / DESCRIPTION
<p><b>0907264</b></p> 	<p><b>5000793641</b></p>	<p>L=153</p> <p>D=28</p>	<p>JK 55/60/65/75 M / S 150/180/210/220/230 TI/250 MIDLINER G.B. S 100/120/135 S 110/130 (VF6JK) S 135/150 (MOT. 040226) S 140/160</p>
<p><b>0927450</b></p> 	<p>-</p> <p>5000792140 (1) 5010358235 (2) 5003090044 (3) 7703066039 (4) 5000737998 (5) 0948381406 (6) 5003087037 (7) 5010056288 (8) 5003055030 (9) - (10) 5010056002 (11) 5000737675 (12) 5005097016 (13)</p>	<p>L=277</p> <p>D=50</p>	<p>G 260/290 R 370/390/420 &gt; 1989 AE 380/385 TI/420 TI/500/520 PR 112/118 PREMIUM (6x2) (6x2/4) &gt; 1999 PREMIUM (FAB 22E/H/J/Q/R) 2000 &gt; MAXTER (4x2) (4x4) (6x4) (8x4) KERAX</p>

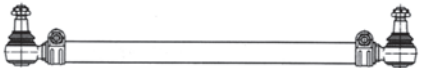
**BARRE ACCOPPIAMENTO - TIE RODS**





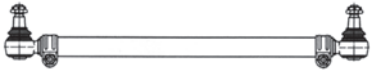
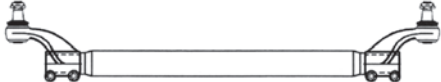

RIF. OCAP OCAP REF.	RIF. ORIG O.E. NUMBER	NOTE REMARKS	MODELLO / DESCRIZIONE MODEL / DESCRIPTION
<p><b>0507780</b></p>  <p><b>0186598</b>      <b>0196598</b> M=30x1,5 RHT    M=30x1,5 LHT</p>	<p><b>388943</b></p>	<p>L=611</p>	<p>G 93/P 93/R 93 P 113/R 113 R 143</p>
<p><b>0507778</b></p>  <p><b>0186598</b>      <b>0196598</b> M=30x1,5 RHT    M=30x1,5 LHT</p>	<p><b>395347</b> 395346</p>	<p>L=1595</p>	<p>G/P/R/T: 93 - 113 - 143</p>
<p><b>0506937</b></p>  <p><b>0186598</b> M=30x1,5 RHT</p>	<p><b>1409918</b> 1369411 1385251 1379168 1501030 1723895 1737683 1897335 2113903 2125090 2161883</p>	<p>L=1601</p>	<p>94-114-124-144-164</p>
<p><b>0507776</b></p>  <p><b>0186598</b>      <b>0196598</b> M=30x1,5 RHT    M=30x1,5 LHT</p>	<p><b>283768</b></p>	<p>L=1630</p>	<p>LB 81- LBS 86</p>
<p><b>0507779</b></p>  <p><b>0186598</b>      <b>0196598</b> M=30x1,5 RHT    M=30x1,5 LHT</p>	<p><b>1363984</b> 395348 1363964 1378436</p>	<p>L=1677</p>	<p>G/P/R/T: 93 - 113 - 143</p>





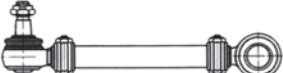

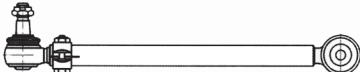
**BARRE ACCOPPIAMENTO - TIE RODS**

RIF. OCAP OCAP REF.	RIF. ORIG O.E. NUMBER	NOTE REMARKS	MODELLO / DESCRIZIONE MODEL / DESCRIPTION
<p><b>0507777</b></p>  <p><b>0186598</b>      <b>0196598</b> M=30x1,5 RHT    M=30x1,5 LHT</p>	<p><b>283766</b></p>	<p>L=1731</p>	<p>LB 111- LBS 111-LBT 111 LB 141- LBS 141- LBT 141</p>
<p><b>0506939</b></p>  <p><b>0186598</b>      <b>0196598</b> M=30x1,5 RHT    M=30x1,5 LHT</p>	<p><b>395350</b> 301639 395432 1397866 1734020 301369 0301369 0395350 03953502 1378435</p>	<p>L=1736</p>	<p>SERIE 4: 94-114-124 T 114- T 124</p>
<p><b>0507725</b></p>  <p><b>0286759</b>      <b>0296759</b> M=52x1,5 RH      M=52x1,5 LH</p>	<p><b>310977</b> 311846 319359 0310977 03109774 3109774</p>	<p>L=1740</p>	<p>93/G/H/M/P/R/T 113 H/M/G/P/R/T 143 E/H/M/G/P/R/T</p>







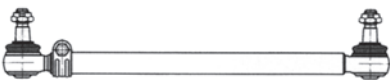





TIRANTI LONGITUDINALI - DRAG LINKS

RIF. OCAP OCAP REF.	RIF. ORIG O.E. NUMBER	NOTE REMARKS	MODELLO / DESCRIZIONE MODEL / DESCRIPTION
<p><b>0507726</b></p>  <p><b>0186598</b> M=30x1,5 RH</p>	<p><b>1394884</b></p>	<p>L=420</p>	<p>94 C/D/G/L- 114 C/G/L 124 G/L- 144 G/L</p>
<p><b>0507766</b></p>  <p><b>0187723</b>      <b>0196598</b> M=30x1,5 RHT      M=30x1,5 LHT</p>	<p><b>1343283</b> 1356055 1759691</p>	<p>L=435</p>	<p>114C/G/L 124C/G/L 144C/G/L</p>
<p><b>0507767</b></p>  <p><b>0186598</b>      <b>0196598</b> M=30x1,5 RHT      M=30x1,5 LHT</p>	<p><b>1343266</b> 1759690</p>	<p>L=495</p>	<p>SERIE 4: 124 G/360 124 G/400 P - G - R - T</p>
<p><b>0507727</b></p>  <p><b>0186598</b> M=30x1,5 RHT</p>	<p><b>382780</b> 0382780 382702</p>	<p>L=554</p>	<p>93- 113- 143</p>
<p><b>0507775</b></p> 	<p><b>388941</b> 1367628 0388941 03889417 1367641</p>	<p>L=554</p>	<p>93 M - 143 M 113 H/M</p>
<p><b>0507188</b></p>  <p><b>0186598</b> M=30x1,5 RHT</p>	<p><b>1369917</b> 300308 306913 382774 0382774</p>	<p>L=578</p>	<p>T 82-T 112/HK/USA T 92-T 93MK/UK T 113/EK/HK/US- T 142- T 143</p>
<p><b>0507999</b></p> 	<p><b>1343262</b> 1869413</p>	<p>L=608 T=42</p>	<p>SERIE 4 - SERIE P-G-R-T</p>



**TIRANTI LONGITUDINALI - DRAG LINKS**

RIF. OCAP OCAP REF.	RIF. ORIG O.E. NUMBER	NOTE REMARKS	MODELLO / DESCRIZIONE MODEL / DESCRIPTION
<p><b>0507924</b></p>  <p><b>0186598</b> M30X1,5 RHT</p>	<p><b>S009593</b> 0087932 389870</p>	<p>L=716 T=50</p>	<p>SERIE: 3</p>
<p><b>0506846</b></p>  <p><b>0186598</b> M=30x1,5 RHT</p>	<p><b>291396</b> 291395</p>	<p>L=728</p>	<p>SERIE 1: 141-143</p>
<p><b>0506914</b></p>  <p><b>0186598</b> M=30x1,5 RHT</p>	<p><b>291398</b></p>	<p>L=761</p>	<p>SERIE 2: 112</p>
<p><b>0507781</b></p>  <p><b>0186598</b> M=30x1,5 RHT</p>	<p><b>1300284</b></p>	<p>L=765</p>	<p>93-113-143</p>
<p><b>0507728</b></p>  <p><b>0186598</b> M=30x1,5 RHT</p>	<p><b>389867</b> 0389867 03898673</p>	<p>L=784</p>	<p>SERIE 3: 93 M- 113 E/H/M 143 E/M/H</p>
<p><b>0507737</b></p>  <p><b>0186598</b> M=30x1,5 RHT</p>	<p><b>1324483</b> 1316872 1305012</p>	<p>L=800</p>	<p>G 93 P 93- P 93 MK- P 93 HK P 113- P 113 EK/HK/MK R 113- R 113 MK/EK/HK- R 143</p>





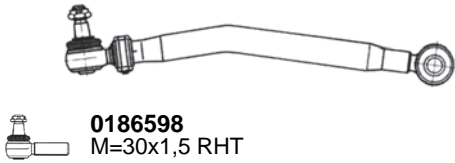
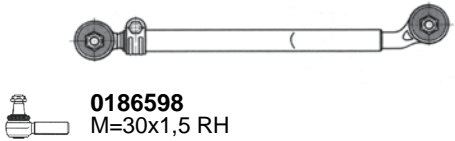
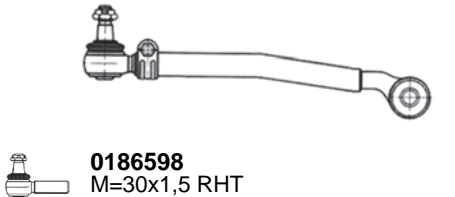
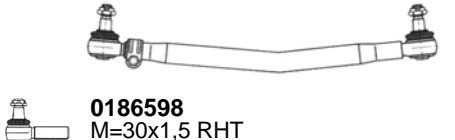
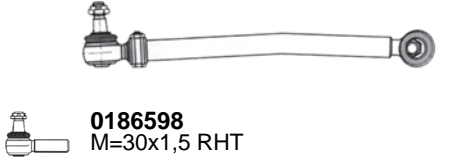

## TIRANTI LONGITUDINALI - DRAG LINKS

RIF. OCAP OCAP REF.	RIF. ORIG O.E. NUMBER	NOTE REMARKS	MODELLO / DESCRIZIONE MODEL / DESCRIPTION
<b>0507782</b>   <b>0186598</b> M=30x1,5 RHT	<b>1305012</b> 1316872 1324483	L=800	93 P 113/R 113 143
<b>0506936</b>   <b>0186598</b> M=30x1,5 RHT	<b>1112511</b>	L=843	93-113-143 Sosp. pneumatiche (Pneumatic suspension)
<b>0506913</b>   <b>0186598</b> M=30x1,5 RHT	<b>390784</b> 0390784 03907847 306913	L=855	G 93- P 93- R 93- P 93 HK P 113 R 113- P 113 R 113 US P 113 R 113 HK/MK R 143 -R 143 EK-HK
<b>0507772</b>   <b>0186598</b> M=30x1,5 RHT	<b>412405</b>	L=898 T=50	SERIE P-R-T
<b>0507729</b>   <b>0186598</b> M=30x1,5 RHT	<b>1112023</b>	L=900	93-113-143
<b>0506919</b>   <b>0186598</b> M=30x1,5 RHT	<b>370875</b> 1369919 1304569 0370875	Lt=865	82-93-112-113-143









**TIRANTI LONGITUDINALI - DRAG LINKS**

RIF. OCAP OCAP REF.	RIF. ORIG O.E. NUMBER	NOTE REMARKS	MODELLO / DESCRIZIONE MODEL / DESCRIPTION
<p><b>0506869</b></p>  <p><b>0186598</b> M=30x1,5 RHT</p>	<p><b>1304571</b> 381339</p>	<p>Lt=872</p>	<p>93-113-143</p>
<p><b>0507735</b></p>  <p><b>0186598</b> M=30x1,5 RH</p>	<p><b>1304569</b> 1369919 370875</p>	<p>L=926</p>	<p>SERIE 3: 92-93-112-113-142-143</p>
<p><b>0506888</b></p>  <p><b>0186598</b> M=30x1,5 RHT</p>	<p><b>345124</b></p>	<p>Lt=872</p>	<p>93-113-143</p>
<p><b>0506829</b></p>  <p><b>0186598</b> M=30x1,5 RHT</p>	<p><b>352637</b></p>	<p>Lt=895</p>	<p>93-112-113-143</p>
<p><b>0506889</b></p>  <p><b>0186598</b> M=30x1,5 RHT</p>	<p><b>352635</b> 278663 278664</p>	<p>L=947</p>	<p>SERIE 3: 93-113-143</p>
<p><b>0506816</b></p>  <p><b>0186598</b> M=30x1,5 RHT</p>	<p><b>278665</b> 278666 0278665</p>	<p>L=947</p>	<p>82-92 112-142 93-113-143</p>





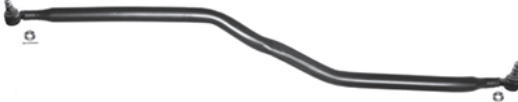



TIRANTI LONGITUDINALI - DRAG LINKS

RIF. OCAP OCAP REF.	RIF. ORIG O.E. NUMBER	NOTE REMARKS	MODELLO / DESCRIZIONE MODEL / DESCRIPTION
<p><b>0506918</b></p>  <p><b>0186598</b> M=30x1,5 RHT</p>	<p><b>306981</b> 0306981</p>	<p>L=947</p>	<p>93-113-142 82-92-112-142</p>
<p><b>0507771</b></p>  <p><b>0186598</b> M=30x1,5 RHT</p>	<p><b>1507260</b> 1897667 482779</p>	<p>L=1044 T=60</p>	<p>SERIE K94 - L 94</p>
<p><b>0509881</b></p>  <p><b>0186598</b> M=30x1,5 RHT</p>	<p><b>1348269</b> 2007275</p>	<p>L=1062 T=52</p>	<p>SERIE 4 - SERIE P-G-R-T</p>
<p><b>0506920</b></p>  <p><b>0186598</b> M=30x1,5 RHT</p>	<p><b>1379071</b> 1384025 1356055 1847311 1912757 1768898</p>	<p>Lt=1010</p>	<p>SERIE 3: 94 D/C/G/L- 114 C/G/L 124 C/G/L- 124 L/FT800 144 C/G/L- 144 L/FT800 164 P/G/R/T</p>
<p><b>0507731</b></p>  <p><b>0186598</b> M=30x1,4 RHT</p>	<p><b>1384027</b> 1912758 1769597 1847312</p>	<p>L=1059</p>	<p>94 C/D/G/L - 114 C/G/L 124 C/G/L - 144 - 164</p>
<p><b>0507764</b></p>  <p><b>0186598</b> M=30x1,5 RHT    <b>0196598</b> M=30x1,5 LHT</p>	<p><b>421573</b></p>	<p>L=1123</p>	<p>F 112/ K 112/ 112L/ S 112 F 113/ K 113TL/ L 113/ LS 113</p>

**TIRANTI LONGITUDINALI - DRAG LINKS**



RIF. OCAP OCAP REF.	RIF. ORIG O.E. NUMBER	NOTE REMARKS	MODELLO / DESCRIZIONE MODEL / DESCRIPTION
<b>0507732</b> 	<b>388942</b> 0388942 3889425	L=1150	93 M- 113 H-M 143
<b>0506916</b> 	<b>1308643</b> 13086434	L=1590	93-113-143
<b>0507733</b> 	<b>1367628</b> 388941 1367641	L=1601	93 M-113 H/M-143 M
<b>0507734</b> 	<b>1367641</b>	L=1601	93 M- 113 H-M- 143 M
<b>0507723</b>   <b>0187723</b> M=30x1,5 RHT	<b>1395614</b> 1361413 1734019	L=1743	SERIE 3 94-114-124-144
<b>0509879</b> 	<b>1343264</b> 1732635 2007278	L=1921 T=60	SERIE 4 - SERIE P-G-R-T
<b>0509885</b> 	<b>1733471</b> 1747467 2007279	L=192 T=42	SERIE 4 - SERIE P-G-R-T
<b>0509884</b> 	<b>1343278</b> 2007274	L=2783 T=60	SERIE 4 - SERIE P-G-R-T

## TESTE STERZO - TIE RODS END







RIF. OCAP OCAP REF.	RIF. ORIG O.E. NUMBER	NOTE REMARKS	MODELLO / DESCRIZIONE MODEL / DESCRIPTION
0187838 	325615	L=75  M=	
0287361 	1394443	L=75  M=26x1,5 RHT	4 SERIES 94-114-124-144-164
0287360 	1394444	L=90  M=26x1,5 RHT	4 SERIES 114-124-144-164-94
0287684 	1375228 1912759	L=95  M=26x1,5 RHT	SERIE 3 - SERIE 4 - P-G-R-T
0186598 	1358793 283784 468286 395010 1738381 0395010 1767328 0283784	L=120  M=30x1,5 RHT	82-92-112-142 93-113-143 94-114-124-144-164 SERIE 4 - SERIE R
0196598 	283783 395009 468285 1358792 1738380	L=120  M=30x1,5 LHT	82-92-112-142 93-113-143 94-114-124-144-164
0186758 	81953010022 0696226 0609643 0586714 0609634 0607073 1337367	L=135  M=30x1,5 RHT	SERIE 2: 112 SERIE 3: 93-113-143 T 93-T 113-T 143 SERIE 4
0196758 	1337366 352645 325537	L=135  M=30x1,5 LH	SERIE 2: 112 SERIE 3: 93-113-143 T 93-T 113-T 143 SERIE 4
0187894 	1723897	L=145  M=30x1,5 RHT	SERIE P - G - R - T SERIES P - G - R - T





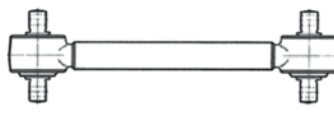

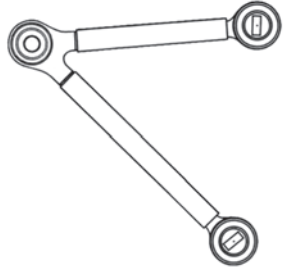
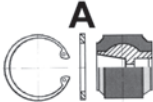

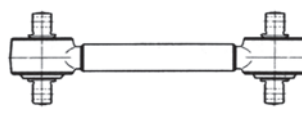

**TESTE STERZO - TIE RODS END**

RIF. OCAP OCAP REF.	RIF. ORIG O.E. NUMBER	NOTE REMARKS	MODELLO / DESCRIZIONE MODEL / DESCRIPTION
<b>0187723</b>  	<b>1357674</b> 1738379	L=150  M=30x1,5 RHT	SERIE 4 - P, G, R, T
<b>0286759</b>  	<b>310980</b> 0310980	L=168  M=52x1,5 RH	93-113-143 Sospensioni pneumatiche anteriori (Pneumatic suspension front)
<b>0296759</b>  	<b>310979</b> 0310979	L=168  M=52x1,5 LH	93-113-143 Sospensioni pneumatiche anteriori (Pneumatic suspension front)



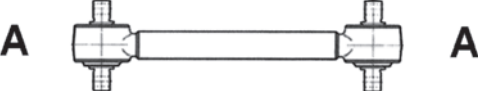

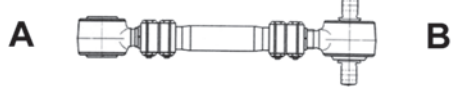

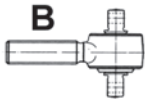
**BARRE DI REAZIONE - TORQUE RODS**

RIF. OCAP OCAP REF.	RIF. ORIG O.E. NUMBER	NOTE REMARKS	MODELLO / DESCRIZIONE MODEL / DESCRIPTION
<b>0807454</b> 	<b>1326771</b> 1326775 1428349	L=522 T=46 l=115	4 SERIE - P-G-R-T SERIE G - SERIE P
<b>0907528</b> 	<b>639370</b> 550799 550806 0639370 1104334 112506 1517403	l=115 p=24 D=62 d=17	
<b>0807771</b> 	<b>1399180</b> 1338769	L=568  d=17	SERIE 3 - SERIE 4
<b>0907528</b> 	<b>639370</b> 550799 550806 0639370 1104334 112506 1517403	l=115 p=24 D=62 d=17	
<b>0807761</b> 	<b>416524</b>	L=600  d=19	F 112/ K 112/ 112TL/ S 112 F 113/K 113TL/ L 113/ LS 113
<b>0907761</b> 	<b>638870</b>	D=80	
<b>0907259</b> 	<b>638862</b> 639287 1104335	l=130 p=30 D=70 d=19	
<b>0807738</b> 	<b>417290</b>	L=635  d=19	K 112- K 113

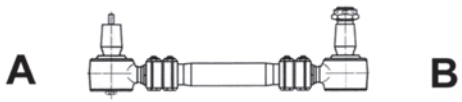

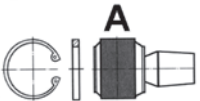
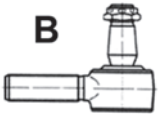

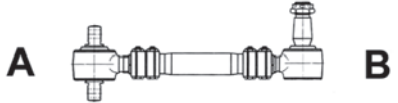
**BARRE DI REAZIONE - TORQUE RODS**

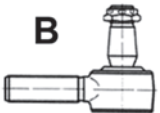
RIF. OCAP OCAP REF.	RIF. ORIG O.E. NUMBER	NOTE REMARKS	MODELLO / DESCRIZIONE MODEL / DESCRIPTION
<b>0907259</b> 	<b>638862</b> 639287 1104335	l=130 p=30 D=70 d=19	
<b>0807997</b> 	<b>1353445</b> 1464611 1942147	L=705 T=42 l=115	4 SERIE - SERIE P-G-R-T
<b>0907508</b> 	<b>550807</b> 5508072	K=38 D=55	
<b>0907997</b> 	<b>550808</b> 5508080	l=115 p=24 D=67 d=17	
<b>0807554</b> 	<b>466801</b> 465816 489987	L=650 d=19	
<b>0907259</b> 	<b>638862</b> 639287 1104335	l=130 p=30 D=70 d=19	
<b>0807772</b> 	<b>445634</b>	L=667 d=19	K 113
<b>0187772</b> 	<b>639362</b>	L=200	
<b>0197751</b> 	<b>639361</b>	L=160	

**BARRE DI REAZIONE - TORQUE RODS**

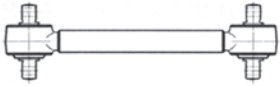
RIF. OCAP OCAP REF.	RIF. ORIG O.E. NUMBER	NOTE REMARKS	MODELLO / DESCRIZIONE MODEL / DESCRIPTION
<p><b>0807759</b></p> 	<b>416800</b>	L=725	F 112/ K 112/ 112 TL/ S 112 F 113/ K 113 TL/ L 113/ LS 113
<p><b>0187759</b></p> 	<b>638869</b>	L=160	
<p><b>0907759</b></p> 	<b>639299</b>	D=70  K=45k	
<p><b>0197523</b></p> 	<b>638680</b>	L=160  M=38x1,5 LHT	
<p><b>0907531</b></p> 	<b>638861</b>	D=70  K=45	
<p><b>0807758</b></p> 	<b>409639</b>	L=750  d=19	F 112/ K 112/ 112 TL/ S 112 F 113/ K 113 TL/ L 113/ LS 113
<p><b>0907259</b></p> 	<b>638862</b> 639287 1104335	l=130 p=30 D=70 d=19	
<p><b>0197523</b></p> 	<b>638680</b>	L=160  M=38x1,5 LHT	

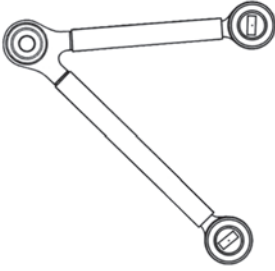





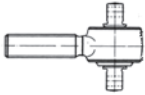
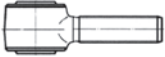

**BARRE DI REAZIONE - TORQUE RODS**

RIF. OCAP OCAP REF.	RIF. ORIG O.E. NUMBER	NOTE REMARKS	MODELLO / DESCRIZIONE MODEL / DESCRIPTION
<b>0907531</b>  <b>B</b> 	<b>638861</b>	D=70  K=45	
<b>0807760</b>  <b>A</b>  <b>A</b>  <b>0907528</b>  <b>A</b> 	<b>414531</b>  <b>639370</b> 550799 550806 0639370 1104334 112506 1517403	L=750  d=17  l=115 p=24 D=62 d=17	SERIE 2: 112 SERIE 3: 113
<b>0807773</b>  <b>A</b>  <b>B</b>  <b>0907773</b>  <b>A</b> 	<b>445632</b> 445631  <b>639288</b> 638938	L=827  d=19  D=80	K 113
<b>0907259</b>  <b>B</b> 	<b>638862</b> 639287 1104335	l=130 p=30 D=70 d=19	



**TESTE BARRE - BALL JOINTS**

RIF. OCAP OCAP REF.	RIF. ORIG O.E. NUMBER	NOTE REMARKS	MODELLO / DESCRIZIONE MODEL / DESCRIPTION
<p><b>0197751</b></p> 	<p><b>639361</b></p>	<p>L=160</p>	<p>K 113</p>
<p><b>0187772</b></p> 	<p><b>639362</b></p>	<p>L=200</p>	<p>K 113</p>

**KIT DI SOSPENSIONE - SUSPENSION KITS**

RIF. OCAP OCAP REF.	RIF. ORIG O.E. NUMBER	NOTE REMARKS	MODELLO / DESCRIZIONE MODEL / DESCRIPTION
<b>0907508</b> 	<b>550807</b> 5508072	K=38  D=55	4 SERIE - SERIE P-G-R-T
<b>0907528</b> 	<b>639370</b> 550799 550806 0639370 1104334 112506 1517403	l=115 p=24 D=62 d=17	SERIE 2 - 3 - 4
<b>0907531</b> 	<b>638861</b>	D=70  K=45	
<b>0907759</b> 	<b>639299</b>	D=70  K=45k	
<b>0907761</b> 	<b>638870</b>	D=80	
<b>0907773</b> 	<b>639288</b> 638938	D=80	F 112/K 112/ K 112TL/ S 112 F 113/K 113/ K 113TL/ L 113/ LS 113
<b>0907529</b> 	<b>1104336</b>	l=152 p=35 D=80 d=32	
<b>0907259</b> 	<b>638862</b> 639287 1104335	l=130 p=30 D=70 d=19	K
<b>0907405</b> 	<b>639319</b> 550812	l=100  D=67 d=17	4 114

**KIT DI SOSPENSIONE - SUSPENSION KITS**

RIF. OCAP OCAP REF.	RIF. ORIG O.E. NUMBER	NOTE REMARKS	MODELLO / DESCRIZIONE MODEL / DESCRIPTION
<p><b>0907919</b></p> 	<p><b>1515981</b></p>	<p>D=75</p>	<p>4 SERIE: 114/124/144/164/94 P-G-R-T SERIE: 230/270/310/340/380/400/420/440/470/500/560/580/620</p>
<p><b>0907997</b></p> 	<p><b>550808</b> 5508080</p>	<p>l=115 p=24 D=67 d=17</p>	<p>SERIE 4 - SERIE P-G-R-T</p>
<p><b>0907623</b></p> 			





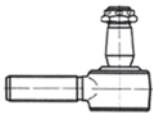
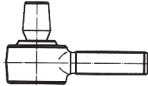





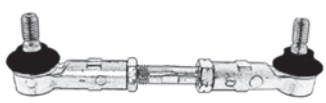

**SNODI SOSPENSIONI - SUSPENSION JOINTS**

RIF. OCAP OCAP REF.	RIF. ORIG O.E. NUMBER	NOTE REMARKS	MODELLO / DESCRIZIONE MODEL / DESCRIPTION
<p><b>0197523</b></p> 	<b>638680</b>	<p>L=160</p> <p>M=38x1,5 LHT</p>	<p>F 112/ K 112/ 112 TL/ S 112 F 113/ K 113 TL/ L 113/ LS 113</p>
<p><b>0187759</b></p> 	<b>638869</b>	<p>L=160</p>	<p>F 112/ K 112/ 112 TL/ S 112 F 113/ K 113 TL/ L 113/ LS 113</p>



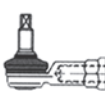
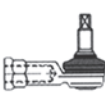

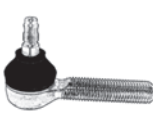
**STABILIZZATORI - STABILIZERS**

RIF. OCAP OCAP REF.	RIF. ORIG O.E. NUMBER	NOTE REMARKS	MODELLO / DESCRIZIONE MODEL / DESCRIPTION
<p><b>0509886</b></p> 	<p><b>1766014</b> 463245</p>	<p>L=100 T=31</p>	<p>SERIE 3 - SERIE 4 - SERIE K</p>











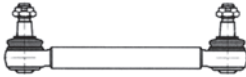
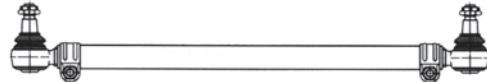

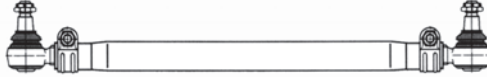
**TESTE COMANDO CAMBIO - GEAR BOX CONTROL BALL JOINTS**

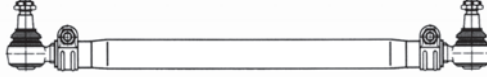
RIF. OCAP OCAP REF.	RIF. ORIG O.E. NUMBER	NOTE REMARKS	MODELLO / DESCRIZIONE MODEL / DESCRIPTION
<b>0507242</b>   <b>0287229</b> M=12x1,75 RHT <b>0297229</b> M=12x1,75 LHT 	<b>305317</b> 371453	L=155	93 H/M 111- 112 H - 113 H /E/M 141- 142-143 E/H/M T113 - T143 - T93
<b>0507243</b>   <b>0287229</b> M=12x1,75 RHT <b>0297229</b> M=12x1,75 LHT 	<b>1427727</b> 371448 1384896	L=260	92-112-142 93-113-143-94
<b>0287229</b> 	<b>305320</b> 371452 1384898	L=55  M=12x1,75 RH	112-113 142-143 SERIE 4: T 114 - T 124 SERIE R
<b>0297229</b> 	<b>305319</b> 371451 1384897	L=55  M=12x1,75 LH	112-113 142-143 SERIE 4: T 114 - T 124 SERIE R
<b>0187228</b> 	<b>1278679</b> 0386930	L=85  M=14 x 1,5 RH	SERIE 3
<b>0187230</b> 	<b>350270</b> 243664 0350270	L=82  M=14x2 RH	SERIE 2: 112-142 SERIE 3: 93-113-143
<b>0187231</b> 	<b>1383405</b>	L=82  M=16x2 RH	124-142-143-144
<b>0407232</b> 	<b>307443</b>	M=12x1,5RH	SERIE 2: 112 H-142 SERIE 3: 93 H/M-113 E/H/M 143 E/H/M-T143 - T93 SERIE 4







**KIT PERNO FUSO - KING PIN SET**

RIF. OCAP OCAP REF.	RIF. ORIG O.E. NUMBER	NOTE REMARKS	MODELLO / DESCRIZIONE MODEL / DESCRIPTION
<p><b>0927452</b></p> 	<p><b>550732</b> 550713 550714</p>	<p>L=228</p> <p>D=53,5/44,5</p>	<p>ASSALE/AXLE: AM 60 - 291311 L-LB 81 1975 &gt; G-P-T 82 1980 &gt; LB-LBS 85 1973 &gt; L-LS86 1975 &gt; LB-LBS 86 1975 &gt; LB-LBS 110 1968 &gt; LB-LBS 111 1971 &gt; L-LS-LT 111 1980&gt; G-P-R 112 1980 &gt; L-LS-LB-LBS 140 1971 &gt; L-LS-LT-LB-LBS 141 1971 &gt; T-R 142 1980 &gt; LT 146</p>
<p><b>0927453</b></p> 	<p><b>550730</b> 550729</p>	<p>L=215</p> <p>D=44,5/55</p>	<p>ASSALE/AXLE: AM 56 - AM 61 G 93 1986 &gt; P 93 1986 &gt; R 93 1986 &gt; P 113 1986 &gt; R 113 1986 &gt; R 143 1986 &gt; T 143 1986 &gt;</p>
<p><b>0927454</b></p> 	<p><b>550257</b></p>	<p>L=223</p> <p>D=55</p>	<p>ASSALE/AXLE: AM 800/820 113 P/R ASSALE/AXLE: 620/920 AMA 860 114 G ASSALE/AXLE: AM/AMA 740 AMA 860 &gt; CH. 9014419 SAN - 4359879 SNL 1219062 SSS - AMD 740 - AMA 860 D 124 C/G/L ASSALE/AXLE: AM620/920 AMA 860 144 G ASSALE/AXLE: AM 740 - AM A 860 144 L</p>
<p><b>0927455</b></p> 	<p><b>550284</b></p>	<p>L=223</p> <p>D=55</p>	<p>ASSALE/AXLE: AM 800/820 113 P/R ASSALE/AXLE: AM 620/920 - AMA 860 114 G ASSALE/AXLE: AM/AMA 740 AMA 860 CH. 9014420 SAN &gt; - 4359880 SNL &gt; 1219063 SSS &gt; - AMD740 - AMA 860 D 124 C/G/L ASSALE/AXLE: AM620/920 AMA 860 144 G ASSALE/AXLE: AM 740 - AMA 860 144 L</p>



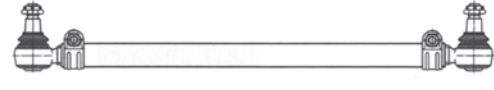

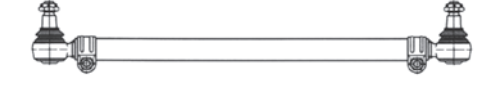
## BARRE ACCOPPIAMENTO - TIE RODS

RIF. OCAP OCAP REF.	RIF. ORIG O.E. NUMBER	NOTE REMARKS	MODELLO / DESCRIZIONE MODEL / DESCRIPTION
<b>0507224</b> 	<b>3112050</b> 9959151 20497798	L=300	
<b>0507709</b>   <b>0186613</b> M=28x1,5 RHT <b>0196613</b> M=28x1,5 LHT 	<b>6853511</b>	L=1407	F 4 F 607-608-609-610
<b>0507716</b>   <b>0186959</b> M=30x1,5 RHT <b>0186959</b> M=30x1,5 LHT 	<b>1571862</b> 1606276	L=1557	FL 616-617
<b>0507109</b>   <b>0186959</b> M=30x1,5 RHT <b>0196959</b> M=30x1,5 LHT 	<b>1626494</b> 1505855 1606274 1611864 16264947	L=1592	B 56 F 7-10-12-16 FL 6-7-10-12 FS 7-10 N 7-10-12 NL 10-12
<b>0507975</b>   <b>0186598</b> M=30x1,5 RHT <b>0196598</b> M=30x1,5 LHT 	<b>20830369</b> 3099230	L=1607 T=40	FL 6 FL 615
<b>0509916</b>   <b>0189896</b> M=30x1,5 RHT	<b>21260274</b>	L=1634 T=50	FH 12-FL 6-FM 7-FM 9-FM 10-FM 12





**BARRE ACCOPPIAMENTO - TIE RODS**

RIF. OCAP OCAP REF.	RIF. ORIG O.E. NUMBER	NOTE REMARKS	MODELLO / DESCRIZIONE MODEL / DESCRIPTION
<p><b>0507708</b></p>  <p><b>0186960</b> M=30x1,5 RHT    <b>0196960</b> M=30x1,5 LHT</p>	<p><b>1080792</b> 6862225</p>	<p>L=1640</p>	<p>F 7-F 10 F 12-F 16 FL 7-FL 10 FL 12</p>
<p><b>0509896</b></p>  <p><b>0189896</b> M=30x1,5 RHT</p>	<p><b>1612254</b> 3985570 20393097 1606897 21260286</p>	<p>L=1640 T=58</p>	<p>F 12-F 16-FH 12-FH 16-FL 6-FL 7-FL 10 FM 7-FM 10-FM 12</p>
<p><b>0507124</b></p>  <p><b>0186946</b> M=30x1,5 RHT    <b>0196946</b> M=30x1,5 LHT</p>	<p><b>3962343</b> 1626637 3988711 3986454 1412254 3986450</p>	<p>L=1645</p>	<p>FH 12/16 FL 4-FM 7/9/10/12/16 NH 12/16</p>
<p><b>0509914</b></p>  <p><b>0189914</b> M=30x1,5 RHT    <b>0199914</b> M=30x1,5 LHT</p>	<p><b>20581086</b> 7420581086</p>	<p>L=1669 T=42</p>	<p>FH 12 - FH 16 - FH 400-420-440-460-500-520-540 - FM 12 - FM</p>
<p><b>0507719</b></p>  <p><b>0186960</b> M=30x1,5 RHT    <b>0196960</b> M=30x1,5 LHT</p>	<p><b>1194390</b></p>	<p>L=1674</p>	<p>B9M - B10M - B12M</p>
<p><b>0509900</b></p>  <p><b>0186959</b> M=30x1,5 RHT    <b>0196959</b> M=30x1,5 LHT</p>	<p><b>8156123</b></p>	<p>L=1674 T=42</p>	<p>FH 12 - FM16</p>

## BARRE ACCOPPIAMENTO - TIE RODS



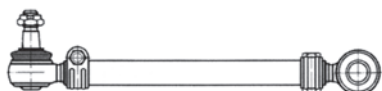







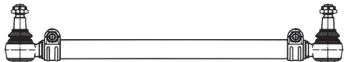

RIF. OCAP OCAP REF.	RIF. ORIG O.E. NUMBER	NOTE REMARKS	MODELLO / DESCRIZIONE MODEL / DESCRIPTION
<b>0509911</b>   <b>0187723</b> M=30x1,5 RHT	<b>22163637</b>	L=1686 T=60	FE II FE 240-260-280-300-320-340
<b>0509894</b>   <b>0187686</b> M=30x1,5 RHT	<b>20399543</b> 21299034 85115631 7420399543	L=1818 T=52	FH 12 - FH 16 - FM 9 - FM12

**TIRANTI LONGITUDINALI - DRAG LINKS**





RIF. OCAP OCAP REF.	RIF. ORIG O.E. NUMBER	NOTE REMARKS	MODELLO / DESCRIZIONE MODEL / DESCRIPTION
<p><b>0507702</b></p>  <p><b>0186946</b> M=30x1,5 RHT    <b>0196946</b> M=30x1,5 LHT</p>	<p><b>1088985</b> 20393083</p>	<p>L=572</p>	<p>FH 12 - FH 16 FM 7 - FM 10 - FM 12 NH 12</p>
<p><b>0507713</b></p>  <p><b>0186960</b> M=30x1,5 RHT</p>	<p><b>6866174</b></p>	<p>L=610</p>	<p>F 7 (8x2) (8x4) F 10- F 12</p>
<p><b>0507714</b></p>  <p><b>0186960</b> M=30x1,5 RHT</p>	<p><b>6866175</b></p>	<p>L=644</p>	<p>F 7 (8x2) (8x4)</p>
<p><b>0507706</b></p>  <p><b>0186960</b> M=30x1,5 RHT    <b>0186960</b> M=30x1,5 LHT</p>	<p><b>1612781</b> 1130567</p>	<p>L=702</p>	<p>F 12/16 FL 7/10/12</p>
<p><b>0506965</b></p>  <p><b>0186960</b> M=30x1,5 RHT</p>	<p><b>1626493</b> 1588263 1606277 1584620</p>	<p>L=710</p>	<p>F 10/12/16 - FL 7/12 N 7/10 - NL 10/12</p>
<p><b>0506966</b></p>  <p><b>0186960</b> M=30x1,5 RHT</p>	<p><b>1588017</b> 1626492 1505857 1577080</p>	<p>L=738</p>	<p>N 7-10-12 NL 10-12</p>









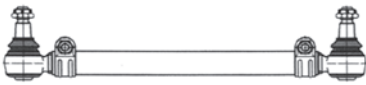



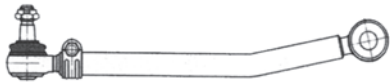

## TIRANTI LONGITUDINALI - DRAG LINKS

RIF. OCAP OCAP REF.	RIF. ORIG O.E. NUMBER	NOTE REMARKS	MODELLO / DESCRIZIONE MODEL / DESCRIPTION
<b>0507245</b>   <b>0186960</b> M=30x1,5 RHT	<b>1588018</b> 1577081	L=738	N 7 (4x2) (6x2) (6x4) N 10 (4x2) (6x2) (6x4) N 12 NL 10 - NL 12
<b>0507720</b>   <b>0186960</b> M=30x1,5 RHT <b>0196960</b> M=30x1,5 LHT 	<b>1094334</b> 1575690	L=750	F 10 (8x4) FL 10
<b>0507119</b>   <b>0186960</b> M=30x1,5 RHT	<b>1094912</b>	L=762	FL 10 (6x4)
<b>0507222</b>   <b>0186946</b> M=30x1,5 RHT	<b>3112122</b> 9959153 20497800	L=763	FL 7 - FL 10
<b>0509893</b>   <b>0186960</b> M=30x1,5 RHT	<b>1094219</b> 20453027	L=813 T=60	FL 10 - FL 12
<b>0507117</b>   <b>0186424</b> M=30x1,5 RHT	<b>1071169</b>	L=821	FL 608-611

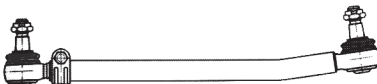





**TIRANTI LONGITUDINALI - DRAG LINKS**

RIF. OCAP OCAP REF.	RIF. ORIG O.E. NUMBER	NOTE REMARKS	MODELLO / DESCRIZIONE MODEL / DESCRIPTION
<p><b>0507105</b></p>  <p><b>0186960</b> M=30x1,5 RHT</p>	<p><b>1080788</b> 1608954</p>	L=835	F 12
<p><b>0506967</b></p>  <p><b>0186960</b> M=30x1,5 RHT</p>	<p><b>1626751</b> 1610338</p>	L=850	F 10-F 12-F 16 FH 12-FH 16
<p><b>0507104</b></p>  <p><b>0186960</b> M=30x1,5 RHT</p>	<p><b>1626750</b> 1610074</p>	L=850	F 10 -F 12 -F 16
<p><b>0507114</b></p>  <p><b>0186960</b> M=30x1,5 RHT</p>	<p><b>1080786</b> 1592959</p>	L=856	F 12-FL 7-FL 10- FL 12
<p><b>0507106</b></p>  <p><b>0186960</b> M=30x1,5 RHT</p>	<p><b>1080787</b> 1608953</p>	L=860	F 12
<p><b>0507680</b></p>  <p><b>0186960</b>      <b>0196960</b> M=30x1,5 RHT    M=30x1,5 LHT</p>	<p><b>1626672</b> 1194824</p>	L=822	FL 7-FL 10- FL 12













## TIRANTI LONGITUDINALI - DRAG LINKS

RIF. OCAP OCAP REF.	RIF. ORIG O.E. NUMBER	NOTE REMARKS	MODELLO / DESCRIZIONE MODEL / DESCRIPTION
<b>0507101</b>   <b>0186960</b> M=30x1,5 RHT	<b>1592939</b> 15929391	L=823	F 7 (8x4) FL 6-7 FL 10 (4x2) (8x4)- FL 12 FS 10
<b>0507100</b>   <b>0186960</b> M=30x1,5 RHT	<b>1592940</b> 15929409	L=823	F 7 (8x4) FL 7-FL 10 (4x2) (8x4) U.K. FL 12
<b>0506968</b>   <b>0186960</b> M=30x1,5 RHT	<b>1613562</b> 1626749	L=880	F 10-F 12-F 16 Sospensione anteriore Pneumatica (Pneumatic suspension front)
<b>0507693</b>   <b>0186960</b> M=30x1,5 RHT	<b>1083744</b>	L=840	F 10-F 12- F 16
<b>0507718</b>   <b>0186960</b> M=30x1,5 RHT	<b>1626670</b> 1611880 16266702	L=848	FL 7 (8x2) (8x4) FL 10-FL 12
<b>0507111</b>   <b>0186946</b> M=30x1,5 RHT	<b>1075663</b> 3988704 20393069	L=861	EM 12 FH 12-FH 16 - FL 4 FM 7-FM 10-FM 12  Sospensioni meccaniche anteriori Dal telaio nr.136426 (Mechanic suspension front Starting from chassis nr.136426)







**TIRANTI LONGITUDINALI - DRAG LINKS**

RIF. OCAP OCAP REF.	RIF. ORIG O.E. NUMBER	NOTE REMARKS	MODELLO / DESCRIZIONE MODEL / DESCRIPTION
<p><b>0507120</b></p>  <p><b>0186946</b> M=30x1,5 RHT</p>	<p><b>1075664</b> 3988701 20393063</p>	L=861	<p>FH 12 FH 16 (Ultima serie-Last chassis) FL 4 - FM 7/9/10/12/16</p>
<p><b>0507688</b></p>  <p><b>0186946</b> M=30x1,5 RHT</p>	<p><b>20393069</b> 1075663 3988704</p>	L=861	<p>FH 12-FH 16 FM 7-FM 10-FM 12 FL 4</p>
<p><b>0507107</b></p>  <p><b>0186946</b> M=30x1,5 RHT</p>	<b>1075005</b>	L=863	<p>FH 12- FH 16 Sospensioni meccaniche anteriori Fino al telaio nr.136425 (Mechanic suspension front Up to chassis nr.136425)</p>
<p><b>0509897</b></p>  <p><b>0186959</b> M=30x1,5 RHT</p>	<p><b>20375555</b> 20393186 21106930 22159733 3986452</p>	L=863 T=52	<p>FH12-FH16-FH-FM7-FM9-FM10-FM12 FM-FMX</p>
<p><b>0509895</b></p>  <p><b>0187686</b> M=30x1,5 RHT</p>	<p><b>20393187</b> 21106952 20375556 21406952</p>	L=863 T=52	<p>FH - FH 12 - FH 16 - FM - FM 7 - FM 9 - FM 10 - FM 12</p>
<p><b>0507108</b></p>  <p><b>0186946</b> M=30x1,5 RHT</p>	<b>1075006</b>	L=863	<p>F 12-F 16 FH 12-FH 16 FL 4-FM 7-FM 12 Sospensioni meccaniche anteriori (Mechanicsuspension front)</p>













## TIRANTI LONGITUDINALI - DRAG LINKS

RIF. OCAP OCAP REF.	RIF. ORIG O.E. NUMBER	NOTE REMARKS	MODELLO / DESCRIZIONE MODEL / DESCRIPTION
<b>0507717</b>   <b>0186948</b> M=30x1,5 RHT	<b>6790473</b>	L=867	FL 616-617
<b>0507681</b>   <b>0186948</b> M=30x1,5 RHT	<b>6790474</b>	L=867	F 4-F 7-F 12-F 16 FL 616-617
<b>0509891</b>   <b>0186959</b> M=30x1,5 RHT	<b>3988708</b> 1628635 20393079 3988710	L=869 T=50	FH 12 - FH 16 - FM 7 - FM 10 - FM12 - NH 12
<b>0506969</b>   <b>0186960</b> M=30x1,5 RHT	<b>1606283</b> 1576092	L=870	F 10- F 12- F 16
<b>0507102</b>   <b>0186960</b> M=30x1,5 RHT	<b>1606284</b> 1576093	L=870	F 10-F 12- F 16
<b>0507712</b>   <b>0186424</b> M=30x1,5 RHT	<b>6876948</b>	L=870	F 6 (611-612-613-314)





**TIRANTI LONGITUDINALI - DRAG LINKS**

RIF. OCAP OCAP REF.	RIF. ORIG O.E. NUMBER	NOTE REMARKS	MODELLO / DESCRIZIONE MODEL / DESCRIPTION
<p><b>0507118</b></p>  <p><b>0186424</b> M=30x1,5 RHT</p>	<p><b>1071344</b> 20400944 3127737</p>	L=871	FL 6-FL 12
<p><b>0507115</b></p>  <p><b>0186424</b> M=30x1,5 RHT</p>	<p><b>6790572</b> 67905729 20400941</p>	L=871	FL 6
<p><b>0507802</b></p>  <p><b>0186424</b> M=30x1,5 RHT</p>	<p><b>6790607</b> 6790766 67906073 20400942</p>	L=871	FL 6
<p><b>0507112</b></p>  <p><b>0186946</b> M=30x1,5 RHT</p>	<p><b>1075153</b> 3988695 3988697 20303061 20393061 3090727</p>	L=881	F 10 FH 12- FH 16- FL 4 FM 7/9/10/12 Sospensioni pneumatiche anteriori (Pneumatic suspension front)
<p><b>0507113</b></p>  <p><b>0186946</b> M=30x1,5 RHT</p>	<p><b>1628636</b> 1075153 3988695 3988697</p>	L=881	FH 12/16 Sospensioni pneumatiche anteriori (Pneumatic suspension front)
<p><b>0507121</b></p>  <p><b>0186948</b> M=30x1,5 RHT</p>	<p><b>6799189</b> 67991893 3124962</p>	L=893	FL 6

## TIRANTI LONGITUDINALI - DRAG LINKS





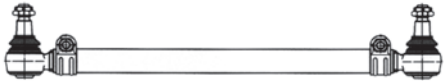





RIF. OCAP OCAP REF.	RIF. ORIG O.E. NUMBER	NOTE REMARKS	MODELLO / DESCRIZIONE MODEL / DESCRIPTION
<b>0509902</b>   <b>0186948</b> M=30x1,5 RHT	<b>6799190</b>	L=893 T=40	FL 6
<b>0507769</b>   <b>0186613</b> M=28x1,5 RHT	<b>6852195</b>	L=900	F 607-608-609-610 CH.578...2117
<b>0507768</b>   <b>0186595</b> M=24X1,5 RHT	<b>6852196</b>	L=900	F 4-F 408
<b>0507710</b>   <b>0186613</b> M=28x1,5 RHT	<b>6852197</b>	L=900	F 4 F-F 408 F 607-608-609-610 B 6 F- B 6 FA
<b>0507122</b>   <b>0186948</b> M=30x1,5 RHT	<b>1071315</b>	L=910	FL 6 FL 18
<b>0507103</b>   <b>0186960</b> M=30x1,5 RHT	<b>1606282</b> 1587489 1576816	L=940	F 7 (4x2-6x2-6x4) F 10- F 12

**TIRANTI LONGITUDINALI - DRAG LINKS**









RIF. OCAP OCAP REF.	RIF. ORIG O.E. NUMBER	NOTE REMARKS	MODELLO / DESCRIZIONE MODEL / DESCRIPTION
<p><b>0507116</b></p>  <p><b>0186612</b> M=24x1,5 RHT</p>	<p><b>3124480</b> 20400909 31244809 3124594 6777855 6791948</p>	<p>L=978</p>	<p>F 6 FE 6 FL 6 (608-611)</p>
<p><b>0507683</b></p>  <p><b>0186960</b> M=30x1,5 RHT</p>	<p><b>8132373</b></p>	<p>L=1022 T=62</p>	
<p><b>0507244</b></p>  <p><b>0186960</b> M=30x1,5 RHT</p>	<p><b>1135630</b> 1127452</p>	<p>L=1106</p>	<p>B 9 M- B 10 MK1</p>
<p><b>0507679</b></p>  <p><b>0186960</b> M=30x1,5 RHT</p>	<p><b>1134840</b></p>	<p>L=1114</p>	<p>B 9 M- B 10 M</p>
<p><b>0507715</b></p>  <p><b>0186612</b> M=24x1,5 RHT    <b>0196612</b> M=24x1,5 LHT</p>	<p><b>6771120</b> 67711200 20400907</p>	<p>L=1556</p>	<p>FL 4 FL 408 FL 6 FL 608-611 FLC 140</p>
<p><b>0507707</b></p>  <p><b>0186424</b> M=30x1,5 RHT    <b>0196424</b> M=30x1,5 LHT</p>	<p><b>6771112</b></p>	<p>L=1582</p>	<p>FE 6-FL 6</p>











## TIRANTI LONGITUDINALI - DRAG LINKS

RIF. OCAP OCAP REF.	RIF. ORIG O.E. NUMBER	NOTE REMARKS	MODELLO / DESCRIZIONE MODEL / DESCRIPTION
<b>0507895</b>   <b>0186960</b> M=30x1,5 RHT	<b>1626671</b> 1613351 1599175	L=1799	FL 10 Per veicoli con guida a destra For RHD vehicles only
<b>0507704</b>   <b>0186960</b> M=30x1,5 RHT	<b>1612857</b>	L=1804	FL 7 FL 10
<b>0507703</b>   <b>0186960</b> M=30x1,5 RHT	<b>1612779</b> 3962768	L=1884	FL 7-10-12
<b>0509898</b>   <b>0186946</b> M=30x1,5 RHT	<b>20393091</b> 20442113 20513951 24425660	L=2140 T=52	FH12 - FM12
<b>0507705</b>   <b>0186960</b> M=30x1,5 RHT	<b>1612858</b>	L=2204	FL 7 FL 10

**TESTE STERZO - TIE RODS END**

RIF. OCAP OCAP REF.	RIF. ORIG O.E. NUMBER	NOTE REMARKS	MODELLO / DESCRIZIONE MODEL / DESCRIPTION
<b>0287457</b>  	<b>1624093</b> 1607483	L=85  M=22x1,5 RHT	F 12 - F 16 - FL 7 - FL 10
<b>0289923</b>  	<b>1271126</b> 42538048 82953016019 81953016268 82953016018 3099128 3090291	L=90 M=36x1,5 RHT	FH12-FH16-FL10-FL12-FM12
<b>0186595</b>  	<b>1518142</b> 1517449 1517452 1190778	L=95  M=24x1,5 RHT	F 10 - F 12 F 406-F 408 FL 7-FL 10 FH 16
<b>0196595</b>  	<b>1517448</b>	L=95  M=24x1,5 LHT	F 10 - F 12 F 406-F 408 FL 7-FL 10 FH 16
<b>0287684</b>  	<b>1606980</b>	L=95  M=26x1,5 RHT	FL 10 - F16
<b>0287458</b>  	<b>8151876</b>	L=100  M=26x1,5 RHT	FH12 - FH16 - FM7 - FL10 - FL12 - FL7 FM10 - FM12 - FM7 - NH12
<b>0186613</b>  	<b>1698191</b> 1517440 1517444	L=105  M=28x1,5 RHT	F 6 (607-608-609-610-611-613-614) F 406-F 407-F 408 FL 4-FL 408
<b>0196613</b>  	<b>1698190</b> 1517279 1517439 1695511 1998190	L=105  M=28x1,5 LHT	F 6 (607-608-609-610-611-613-614) F 406-F 407-F 408 FL 4-FL 408
<b>0186612</b>  	<b>1696919</b>	L=105  M=24x1,5 RHT	FL 4-FL 408 FL 6-608-611-612-614 FLC 140







## TESTE STERZO - TIE RODS END

RIF. OCAP OCAP REF.	RIF. ORIG O.E. NUMBER	NOTE REMARKS	MODELLO / DESCRIZIONE MODEL / DESCRIPTION
0196612 	1696920	L=105  M=24x1,5 LHT	FL 4-FL 408 FL 6-608-611-612-614 FLC 140
0186424 	1697247 1695690 1696057 1517577	L=115  M=30x1,5RHT	B 6-F 6 FL 6
0196424 	1698839 1695689 1517647	L=115  M=30x1,5 LHT	B 6-F 6 FL 6
0186946 	3090727 3110002 3988965 3090472	L=115  M=30x1,5 RHT	F 12-F 16 FH 12- FH 16 FM 7- FM 9-FM 10-FM 12 NH 12
0196946 	3090728 3110001 3988968	L=115  M=30x1,5 LHT	F 12-F 16 FH 12- FH 16 FM 7- FM 9-FM 10-FM 12 NH 12
0186948 	1698047 1697246 1506269	L=120  M=30x1,5 RHT	F 4-F 6-F 7-F 10-F 12-F 16 FE 615 FL 4-FL 6- FL 7-FL 10-FL 12 FS 7
0186959 	1698846 1505759 1507823 1698532	L=120  M=30x1,5 RHT	F 7-F 10-F 12-F 16 FH 12-FH 16 FL4-FL 6-FL 7-FL 10 FL 12-FL 616- FL 617 FM 7-FM 9-FM 10-FM 12 N 7- N 10- N 12-NH 12 NL 10- NL 12 - FS 7
0196959 	1698847 1505758 1507822 1698533 3092471 3110011 366757 6884001	L=120  M=30x1,5 LHT	F 7-F 10-F 12-F 16 FH 12-FH 16 FL4-FL 6-FL 7-FL 10 FL 12-FL 616- FL 617 FM 7-FM 9-FM 10-FM 12 N 7- N 10- N 12-NH 12 NL 10- NL 12 - FS 7



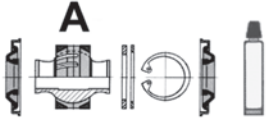

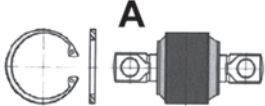
**TESTE STERZO - TIE RODS END**

RIF. OCAP OCAP REF.	RIF. ORIG O.E. NUMBER	NOTE REMARKS	MODELLO / DESCRIZIONE MODEL / DESCRIPTION
<b>0186960</b> 	<b>1695776</b> 1507826 1695585 1698557 619687 0356310 6882111	L=120  M=30x1,5 RHT	F 6-F 7-F 10-F 12-F 16 FL 7-FL 10-FL 12 N 7-N 10-N 12 NL 10-NL 12 FM 7/10/12
<b>0196960</b> 	<b>1698840</b> 1131744 1698558 6869744 1313744 6882112	L=120  M=30x1,5 LHT	F 6-F 7-F 10-F 12-F 16 FL 7-FL 10-FL 12 N 7-N 10-N 12 NL 10-NL 12 FM 7/10/12
<b>0189914</b> 	<b>20581089</b>	L=136  M=30x1,5 RHT	FH 12 - FH 16 FH 400-420-440-460-500-520-540 FM 12 - FM - FMX
<b>0199914</b> 	<b>20710008</b>	L=136  M=30x1,5 LHT	FH 12 - FH 16 FH 400-420-440-460-500-520-540 FM 12 - FM - FMX
<b>0187686</b> 	<b>3093647</b> 21263821	L=140 M=30x1,5 RHT	FH12-FH16-FM7-FMX-FH2-FM-FM9-NH12
<b>0189896</b> 	<b>21263974</b> 3099529 3097228 3092189	L=145  M=30x1,5 RHT	F 12-F 16-FH 12-FH 16-FL 6-FL 7-FL 10-FM 7-FM 10-FM 12
<b>0286964</b> 	<b>1699401</b> 1131742 1696901	L=168  M=52x1,5 RHT	F 7-F 10-F 12-F 80 FH 12- FH 16 FL 7-FL 10- FL 12 FM 7-FM 10-FM 12 N 7-N 10
<b>0296964</b> 	<b>1699400</b> 1131741 1696900	L=168  M=52x1,5 LHT	F 7-F 10-F 12-F 80 FH 12- FH 16 FL 7-FL 10- FL 12 FM 7-FM 10-FM 12 N 7-N 10



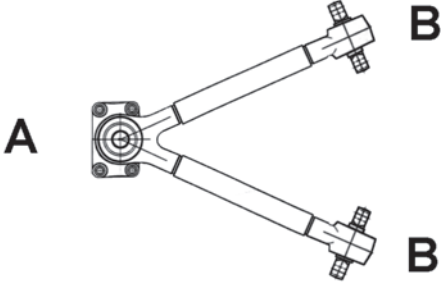
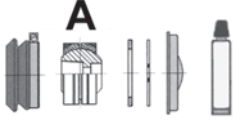

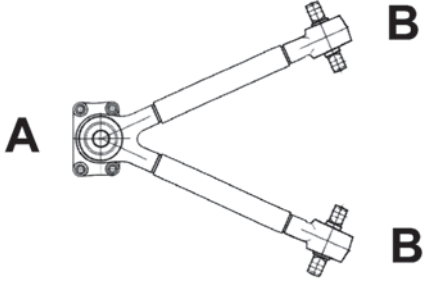
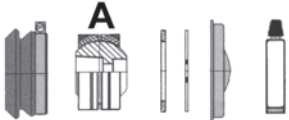
## BARRE DI REAZIONE - TORQUE RODS

RIF. OCAP OCAP REF.	RIF. ORIG O.E. NUMBER	NOTE REMARKS	MODELLO / DESCRIZIONE MODEL / DESCRIPTION
<b>0807691</b> 	<b>1629668</b> 3986443 20477805	L=327	FH 12-FH 16-FL 4 FM 7-FM 9-FM 10-FM 12 NH 12
<b>0807770</b> <b>A</b>  <b>A</b>	<b>6777705</b> 3951306 6797979	L=510	FL 608-FL 611-FL 612
<b>0907770</b> 	<b>3090015</b>	L=60  D=40 d=20	
<b>0807918</b> 	<b>20443061</b> 20444418	L=435	FH 12- FM 9
<b>0807690</b> <b>A</b>  <b>A</b>	<b>1626958</b> 1626957	L=571  d=21	FH 12-FH 16 FL 6-FM 7-FM 9-FM 10-FM 12 NH 12 FH 400 - 440 - 480 - 520
<b>0907359</b> 	<b>274019</b> 273373 691709 4941233 6889509	l=130 p=30 D=70 d=21	
<b>0809917</b> <b>A</b>  <b>A</b>		L=625	FH-FH12-FH16-FM-FM7-FM9-FM10-FM12 FL6-NH12-B7-B7R
<b>0907528</b> <b>A</b> 	<b>271187</b>	l=115 p=24 D=62 d=17	



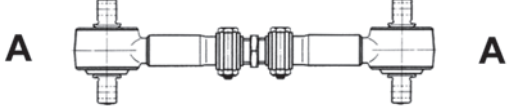

**BARRE DI REAZIONE - TORQUE RODS**

RIF. OCAP OCAP REF.	RIF. ORIG O.E. NUMBER	NOTE REMARKS	MODELLO / DESCRIZIONE MODEL / DESCRIPTION
<p><b>0807221</b></p> 	<p><b>1080690</b> 1576952 1606200 1509222</p>	<p>L=635  d=23</p>	<p>F 7-F 10-F 12-F 16 FL 7-FL 10-FL 12 N 10-N 12-N 10 BR-N 12BR NL 10-NL 12</p>
<p><b>0907683</b></p> 	<p><b>276191</b></p>	<p>D=80  IK=46</p>	
<p><b>0907686</b></p> 	<p><b>276192</b></p>	<p>I=152 p=24 D=80 d=23</p>	
<p><b>0807544</b></p> 	<p><b>1606552</b></p>	<p>L=641  d=21</p>	<p>F7-F10 (260-320) F 12 (320-330-370)- F 16 FL 7 (230-260-290)-FL 10 (320-360) FL12 (380-420) N 10</p>
<p><b>0907545</b></p> 	<p><b>274069</b></p>	<p>D=65  IK=42</p>	
<p><b>0907304</b></p> 	<p><b>274068</b></p>	<p>I=152 p=24 D=70 d=21</p>	

## BARRE DI REAZIONE - TORQUE RODS

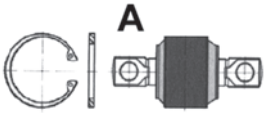



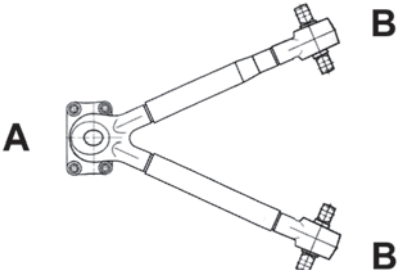
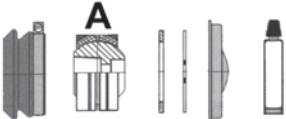
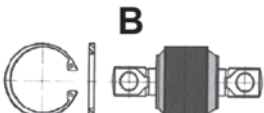

RIF. OCAP OCAP REF.	RIF. ORIG O.E. NUMBER	NOTE REMARKS	MODELLO / DESCRIZIONE MODEL / DESCRIPTION
<b>0809908</b> 	<b>1590068</b>	L=644 T=46 l=115 d=17	F 10 - F 12 - F16 - FL 10 - FL 12 - FL 7 - N 10
<b>0907406</b> 	<b>3133173</b>	D=65	
<b>0907528</b> 	<b>271187</b>	l=115 p=24 D=62 d=17	
<b>0809909</b> 	<b>20502944</b> 1094466 20382314	L=649 T=48 l=115 d=17/20	FL 12 - FL 6 - FL
<b>0909909</b> 	<b>3090452</b> 3092452	l=115 p=24 D=75 d=17/20	
<b>0807687</b> 	<b>8158207</b> 1581527 581528 1607079 8154018 8158206 8154017	L=660  d=21	F 7-F10 (260-320) F 12 (320-330-370) FL 7 (230-260-290) FL 10 (320-360) FL 12 (380-420) N 10-N 12

**BARRE DI REAZIONE - TORQUE RODS**



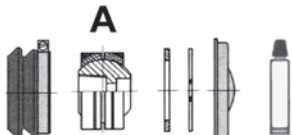

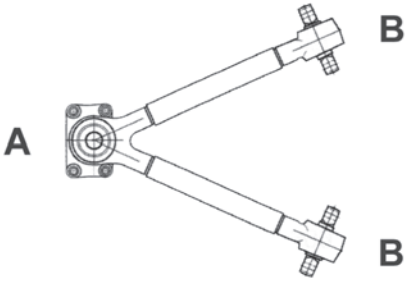



RIF. OCAP OCAP REF.	RIF. ORIG O.E. NUMBER	NOTE REMARKS	MODELLO / DESCRIZIONE MODEL / DESCRIPTION
<b>0907359</b> 	<b>274019</b> 273373 691709 4941233 6889509	l=130 p=30 D=70 d=21	
<b>0807222</b> 	<b>1082104</b> 1605035	L=666 T=48	F10-F12-F16-FH12-FH16 FL10-FL12-FL7-FM10-FM12
<b>0907222</b> 	<b>1598588</b>	l=125 p=20 D=91 d=14	
<b>0907224</b> 	<b>1135080</b>	D=91 d=52	
<b>0807762</b> 	<b>1076639</b> 20392649 20829503 8154016 1606551 1626896 1629734 21295227	L=671  d=21	F12 - FH12 - FH16 FL7 - FL10 - FL12 FM7 - FM9 - FM12 NH12 FH400 - 440 - 480 - 520
<b>0907762</b> 	<b>3090712</b>	D=80	
<b>0907763</b> 	<b>3093631</b>	l=130  D=70 d=21	

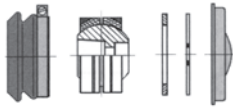
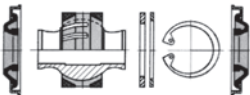

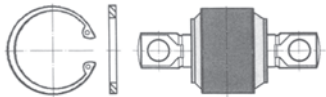

## BARRE DI REAZIONE - TORQUE RODS

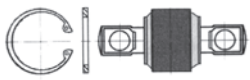
RIF. OCAP OCAP REF.	RIF. ORIG O.E. NUMBER	NOTE REMARKS	MODELLO / DESCRIZIONE MODEL / DESCRIPTION
0807914 	20589061		FH12 - FH16 - FM
0809907 	3172829 8073569	L=678 T=48	FH 12-FH 16-FH-FL 12-FM 7-FM 9-FM 10-FM 12-NH 12
0907487 	271188	IK=38 D=65	
0907529 	274056 276192	l=152 p=35 D=80 d=23	
0807529 	1576953	L=650 d=21	F 7-F 86 GB FL 7-FL 10-FL 12-N 10
0907533 	273706	L=61 IK=46 D=80	
0907529 	274056 276192	l=152 p=35 D=80 d=23	





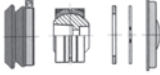

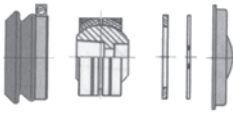
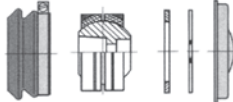
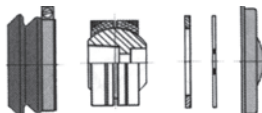
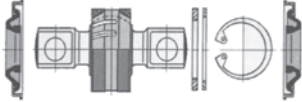
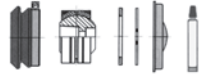
**KIT DI SOSPENSIONE - SUSPENSION KITS**

RIF. OCAP OCAP REF.	RIF. ORIG O.E. NUMBER	NOTE REMARKS	MODELLO / DESCRIZIONE MODEL / DESCRIPTION
<b>0907545</b> 	<b>274069</b>	D=65  IK=42	LP LP LP LPS MK NG SK F 7 - F10 - F12 - FL 7 - FL 10 - FL12
<b>0907770</b> 	<b>3090015</b>	L=60  D=40 d=20	FL 608 - 611 - 612 - 614 - 615 - 618
<b>0909909</b> 	<b>3090452</b> 3092452	l=115 p=24 D=75 d=17/20	FH12-FH16-FL 12-FL 6-FL-FM 10-FM12-FM9-FM
<b>0907222</b> 	<b>1598588</b>	l=125 p=20 D=91 d=14	F10-F12-F16-FH12-FH16-FL10-FL12-FL7-F M10-FM12
<b>0907224</b> 	<b>1135080</b>	D=91 d=52	F10-F12-F16-FH12-FH16-FL10-FL12-FL7-F M10-FM12
<b>0907359</b> 	<b>274019</b> 273373 691709 4941233 6889509	l=130 p=30 D=70 d=21	F 10 - F 12 - F 16 FH 12 - FH 16 FL 7 - FL 10 - FL12
<b>0907304</b> 	<b>274068</b>	l=152 p=24 D=70 d=21	F 7 - F 12 - F 16 FL 7 - FL 10 - FL 12
<b>0907763</b> 	<b>3093631</b>	l=130  D=70 d=21	F12 - FH12 - FH16 FL7 - FL10 - FL12 FM7 - FM9 - FM12 NH12 FH400 - 440 - 480 - 520
<b>0907529</b> 	<b>274056</b> 276192	l=152 p=35 D=80 d=23	F 10 -F 12-FL 7 - FL 10 - FL12

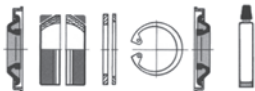



## KIT DI SOSPENSIONE - SUSPENSION KITS

RIF. OCAP OCAP REF.	RIF. ORIG O.E. NUMBER	NOTE REMARKS	MODELLO / DESCRIZIONE MODEL / DESCRIPTION
<b>0907405</b> 	<b>275988</b>	l=100  D=67 d=17	F 12 - FH 12 - FH 16 - FL10 FM 12 - NH 12
<b>0907683</b> 	<b>276191</b>	D=80  IK=46	F 7-F 10-F 12-F 16 FL 7-FL 10-FL 12 N 10-N 12-N 10 BR-N 12BR NL 10-NL 12
<b>0907686</b> 	<b>276192</b>	l=152 p=24 D=80 d=23	F 7-F 10-F 12-F 16 FL 7-FL 10-FL 12 N 10-N 12-N 10 BR-N 12BR NL 10-NL 12
<b>0907297</b> 	<b>3093469</b>	IK=38  D=65	FH16
<b>0907487</b> 	<b>271188</b>	IK=38  D=65	FH12 - FH16 FL7 - FL10 - FL12 FM7 - FM12
<b>0907257</b> 	<b>271188</b>	IK=38  T=50 D=65	FH12 - FH16 FM7 - FM12 FL7 - 10 - 12 NH12
<b>0907534</b> 	<b>273375</b>	l=152 p=35 D=80 d=23	FL 7 - FL 10 - FL 12
<b>0907762</b> 	<b>3090712</b>	D=80	F12 - FH12 - FH16 FL7 - FL10 - FL12 FM7 - FM9 - FM12 NH12 FH400 - 440 - 480 - 520



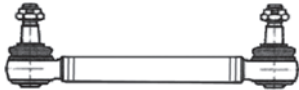

**KIT DI SOSPENSIONE - SUSPENSION KITS**

RIF. OCAP OCAP REF.	RIF. ORIG O.E. NUMBER	NOTE REMARKS	MODELLO / DESCRIZIONE MODEL / DESCRIPTION
<b>0907722</b> 		D=80	FL7 - 10 - 12 NL10 - 12
<b>0907533</b> 	<b>273706</b>	L=61  IK=46 D=80	F 7 - F 12 FL 7 - FL 10 - FL 12
<b>0907528</b> 	<b>271187</b>	l=115 p=24 D=62 d=17	F 10 - F 12 - F 16 FL 7 - FL 10 - FL 12 FM 7 - FM 12 FH 12 - FH16 N10 - NH 12
<b>0907913</b> 	<b>20741710</b> 3093544		FE - FH12 - FH 400 > 520 - FL6 FM 12 - FM 7 - FM9 - FM
<b>0907919</b> 	<b>20547286</b>	D=75	FE - FH12 - FH 400 > 520 - FL6 FM 12 - FM 7 - FM9 - FM
<b>0907406</b> 	<b>3133173</b>	D=65	F10 - F12 - F16 - FL10 - FL12

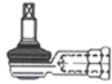
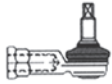
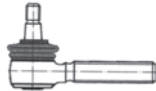

## STABILIZZATORI - STABILIZERS

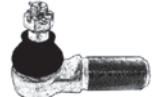
RIF. OCAP OCAP REF.	RIF. ORIG O.E. NUMBER	NOTE REMARKS	MODELLO / DESCRIZIONE MODEL / DESCRIPTION
<b>0109903</b>  	<b>948372</b>	L=40  M=8x1 RHT	F 12 - F 16 - FH 12 - FH 16 - FL 6 - FL 7 - FL 10 - FH 400-440-480
<b>0507123</b>  		Lt=325	
<b>0507221</b>  	<b>20443062</b> 20443066 20994419 21248088	L=380 T=36	FH 12 - FH 16
<b>0509905</b>  	<b>3173613</b> 3987354	L=435 T=36	FH 12 - FM 12 - FM 7
<b>0509915</b>  	<b>21286847</b> 21119064 21287061	L=435 T=36	FH 12 - FH 16 - FH 400-420-440-460-500-520-540 - FM 9 - FM





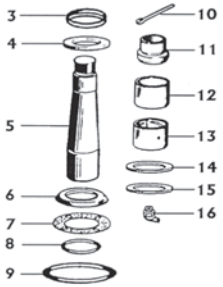
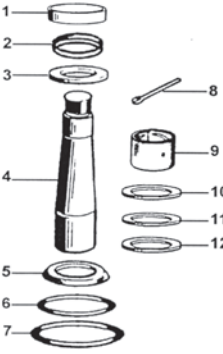







**TESTE COMANDO CAMBIO - GEAR BOX CONTROL BALL JOINTS**

RIF. OCAP OCAP REF.	RIF. ORIG O.E. NUMBER	NOTE REMARKS	MODELLO / DESCRIZIONE MODEL / DESCRIPTION
<b>0287229</b>  	<b>1696685</b>	L=55  M=12x1,75 RH	F 7-F 10-F 12-F 16 FH 12-FH 16 FL 608-614-615-616-617-619 FS 7
<b>0297229</b>  	<b>1696684</b>	L=55  M=12x1,75 LH	F 7-F 10-F 12-F 16 FH 12-FH 16 FL 608-614-615-616-617-619 FS 7
<b>0187682</b>  	<b>382613</b>	L=55  M=12 x1,50 RH	F 10-F 12-FL 7-FL 10-FL 12 SR 62-SR 70-R 70
<b>0187228</b>  	<b>1672152</b> 6853913 6027074 1132493	L=85  M=14 x 1,5 RH	F 4-F 6 F 10-F 12-F 16 FL 408-FL 6
<b>0187241</b>  	<b>1527234</b> 1668638 382745	L=90  M=28x1,5 RH	F 7-F 10-F12-F 16 FL 6-FL 7-FL 10-FL 12 N 7-N 10-N 12
<b>0187456</b>  	<b>1668179</b> 1669010	L=97  M=16x1,5 RHT	FH12 - FH16 - FM7 - FM10 - FM12 - NH12

## KIT PERNO FUSO - KING PIN SET



RIF. OCAP OCAP REF.	RIF. ORIG O.E. NUMBER	NOTE REMARKS	MODELLO / DESCRIZIONE MODEL / DESCRIPTION
<b>0927456</b>  	<b>3090267</b> 271141 270911 276015 276024 276030 276032	L=237  D=48	ASSALE/AXLE: 253270-253283-253295 F7 - F10 - F12 - F16 N7 - N10 - N12 - FL
<b>0927458</b>  	<b>3090266</b> 271142 270912 276023 276031	L=251  D=50/38	ASSALE/AXLE: 253290 F7 - F S 7 - F10 - F12 - F16 FH 12 - FH 16 - FL7 - FL10 - FL12 FM7 - FM12 - N7 - N10 NL10 - NL12
<b>0927221</b>  	<b>20751021</b>		8500-9700-B12-FH12-FH16-FH400-540-FH II-FL-FL6 FM12-FM9-FM-FMX-FMX II

## TIRANTI LONGITUDINALI - DRAG LINKS



RIF. OCAP OCAP REF.	RIF. ORIG O.E. NUMBER	NOTE REMARKS	MODELLO / DESCRIZIONE MODEL / DESCRIPTION
<b>0507128</b>   <b>0187125</b> M=38x1,5 RHT <b>0197125</b> M=38x1,5 LHT 	<b>004908</b>	Lt=450	INBUS 330
<b>0507126</b> 	<b>002765</b>	Lt=590	MENARINI U 150 SICCA 181C-181/1C
<b>0507127</b> 	<b>004909</b>	Lt=600	INBUS-SICCA 166L B
<b>0507924</b>   <b>0186598</b> M30x1,5 RHT	<b>S009593</b> 0087932 389870	L=716 T=50	-
<b>0507129</b>   <b>0187125</b> M=38x1,5 RHT	<b>002763</b> 004728	Lt=725	MENARINI U150 SICCA 181C-181/1C
<b>0507131</b>   <b>0186598</b> M=30x1,5 RHT <b>0196598</b> M=30x1,5 LHT 	<b>065475</b> 065472 065475.0	Lt=805	MENARINI 201 L
<b>0507134</b> 	<b>000221</b>	Lt=805	INBUS 280 FT





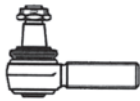
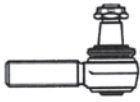

**TIRANTI LONGITUDINALI - DRAG LINKS**

RIF. OCAP OCAP REF.	RIF. ORIG O.E. NUMBER	NOTE REMARKS	MODELLO / DESCRIZIONE MODEL / DESCRIPTION
<p><b>0507132</b></p>  <p><b>0187125</b> M=38x1,5 RHT</p>	<p><b>000218</b></p>	<p>Lt=1170</p>	<p>INBUS - SICCA</p>
<p><b>0507130</b></p> 	<p><b>004729</b></p>	<p>Lt=1260</p>	
<p><b>0507133</b></p>  <p><b>0186598</b> M=30x1,5 RHT</p>	<p><b>043102</b> 043102.3</p>	<p>Lt=1300</p>	<p>MENARINI 201 L</p>



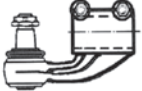
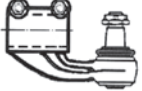

## TESTE STERZO - TIE RODS END

RIF. OCAP OCAP REF.	RIF. ORIG O.E. NUMBER	NOTE REMARKS	MODELLO / DESCRIZIONE MODEL / DESCRIPTION
<b>0186598</b> 	<b>004206</b> 189716	L=120  M=30x1,5 RHT	MENARINI
<b>0196598</b> 	<b>004204</b> 189717	L=120  M=30x1,5 LHT	MENARINI
<b>0187125</b> 	<b>000978</b>	L=120  M=38x1,5 RHT	INBUS SICCA
<b>0197125</b> 	<b>000192</b> 000977	L=120  M=38x1,5 LHT	INBUS SICCA



**TESTE STERZO - TIE RODS END**

RIF. OCAP OCAP REF.	RIF. ORIG O.E. NUMBER	NOTE REMARKS	MODELLO / DESCRIZIONE MODEL / DESCRIPTION
<b>0186424</b> 	<b>0586753</b> 1229944 0607999 0694298 0694360 0698609 586753 698609	L=115  M=30x1,5 RH	MB 230-SB 210 SB 2300-SB 2305-SB 3000
<b>0196424</b> 	<b>1319838</b> 0311300 0607998 1315447 1338714 1407394	L=115  M=30x1,5 LH	MB 230-SB 210 SB 2300-SB 2305-SB 3000
<b>0186598</b> 	<b>1257890</b> 0607981 0698450 0696226	L=120  M=30x1,5 RH	SB 2000-SB 2500
<b>0196598</b> 	<b>1228115</b> 0607053 1329134 0696225	L=120  M=30x1,5 LHT	SB 2000-SB 2500
<b>0286427</b> 	<b>0606923</b> 606923	L=130  M=46x1,5 RHT	MGB/MB 200 TB 2100
<b>0296427</b> 	<b>0606922</b> 606922	L=130  M=46x1,5 LHT	MGB/MB 200 TB 2100



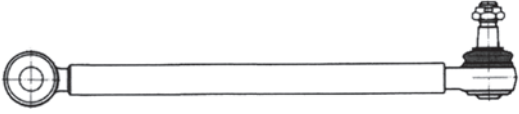
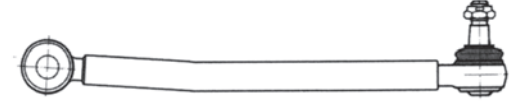
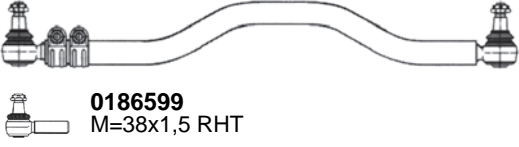

## BARRE ACCOPPIAMENTO - TIE RODS

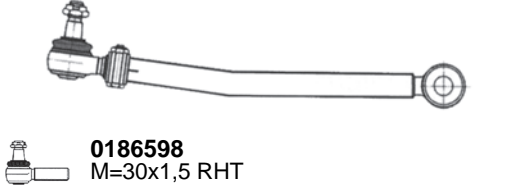
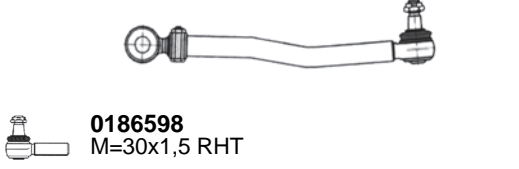
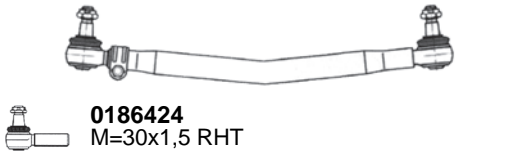
RIF. OCAP OCAP REF.	RIF. ORIG O.E. NUMBER	NOTE REMARKS	MODELLO / DESCRIZIONE MODEL / DESCRIPTION
<b>0586419</b>  <b>0186598</b> M=30x1,5 RHT	<b>4826513</b> 4827082 4862449 4862451	L=780 T=48	TURBOCITY: 480-580-680
<b>0596419</b>  <b>0186598</b> M=30x1,5 RHT	<b>4838587</b> 4822291	L=780 T=48	TURBOCITY: 480-580-680
<b>0506762</b>  <b>0186598</b> M=30x1,5 RHT	<b>42044493</b>	L=796 T=48	470.20 470.20 U-EFFEUNO 570.20-571.20 670.20 671.24 I.EFFEUNO
<b>0509918</b>  <b>0186424</b> M=30x1,5 RHT <b>0196424</b> M=30x1,5 LHT	<b>504126384</b> 5801891027	L=803 T=38	IRISBUS: ARWAY-CROSSWAY-EVADYS-MAGELYS- RECREO

**TIRANTI LONGITUDINALI - DRAG LINKS**

RIF. OCAP OCAP REF.	RIF. ORIG O.E. NUMBER	NOTE REMARKS	MODELLO / DESCRIZIONE MODEL / DESCRIPTION
<b>0507167</b> 	<b>4557357</b>		306
<b>0507170</b> 	<b>42019074</b>	Lt=635	AP 160 AP 160.12.26
<b>0507169</b> 	<b>4704239</b> 4716557	Lt=800	370.12.26
<b>0506795</b> 	<b>2506671</b> 6013743	Lt=930	230E113 260E13-260E113
<b>0506931</b> 	<b>41005463</b> 8131582 8132397 41042919	L=953	CITYCLASS: 591.27
<b>0507850</b> 	<b>98473328</b>	L=966	EUROFIRE TECT: 100E21
<b>0507853</b> 	<b>500363545</b>	L=1114	TECTOR: CC100E18/E21





## TIRANTI LONGITUDINALI - DRAG LINKS

RIF. OCAP OCAP REF.	RIF. ORIG O.E. NUMBER	NOTE REMARKS	MODELLO / DESCRIZIONE MODEL / DESCRIPTION
<b>0507852</b>   <b>0186424</b> M=30x1,5 RHT	<b>500362533</b>	L=1190	TECTOR: CC130E24
<b>0506781</b> 	<b>4672795</b>		409 VAR. 10-10/1
<b>0506774</b> 	<b>4659860</b>		343/L/ST
<b>0507168</b> 	<b>4668771</b>		308-343

**TESTE STERZO - TIE RODS END**





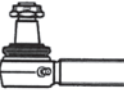
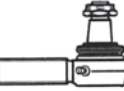

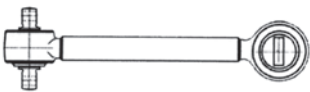

RIF. OCAP OCAP REF.	RIF. ORIG O.E. NUMBER	NOTE REMARKS	MODELLO / DESCRIZIONE MODEL / DESCRIPTION
<b>0186424</b> 	<b>579342</b>	L=115  M=30x1,5 RHT	5061 DA 5062 A 5062 B 5063 DR
<b>0196424</b> 	<b>579343</b>	L=115  M=30x1,5 LHT	5061 DA 5062 A 5062 B 5063 DR
<b>0287552</b> 	<b>42534911</b>	L=80  M=16x1,5 RH	40C13 50C13 50C15
<b>0287238</b> 	<b>93192809</b>	L=91  M=30x1,5 RH	CITYCLASS: 491.24CNG - 591.27  Testa per servosterzo terzo asse (Tie rod end for power steering axle)
<b>0186604</b> 	<b>4028250</b>		308/343 409 VAR. 10-10/I
<b>0196604</b> 	<b>4028251</b>		308/308 L 309 A
<b>0186599</b> 	<b>4688948</b>	L=120  M=38x1,5 RH	370.20/.24/.25/.25L/.26/.30/.35
<b>0186598</b> 	<b>2966252</b> 42537936 42488269 42483386 4802443 2969808 42489594 8122752 42489573 42491638	L=120  M=30x1,5 RHT	TURBOCITY 480 - 580

## TESTE STERZO - TIE RODS END



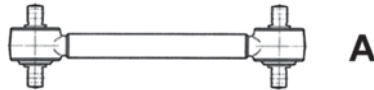

RIF. OCAP OCAP REF.	RIF. ORIG O.E. NUMBER	NOTE REMARKS	MODELLO / DESCRIZIONE MODEL / DESCRIPTION
0196598 	574274	L=120  M=30x1,5 LHT	TURBOCITY 480 - 580
0186605 	4664297	L=130  M=38x1,5 RHT	306/343/L/ST
0187166 	4664340	L=130 M=42x1,5 RHT	
0197166 	4664341	L=130 M=42x1,5 LHT	
0186620 	4661613	L=135  M=38x1,5 RH	421 A/AL
0196620 	4661614	L=135  M=38x1,5 LH	

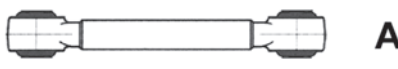



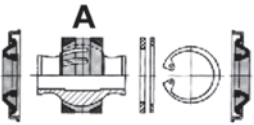

**BARRE DI REAZIONE - TORQUE RODS**

RIF. OCAP OCAP REF.	RIF. ORIG O.E. NUMBER	NOTE REMARKS	MODELLO / DESCRIZIONE MODEL / DESCRIPTION
<b>0807339</b>  <b>A</b>	<b>99432565</b>	L=510  d=15	490.29E2 490.18.29E2 > C.H. 1996-01-03 CITYCLASS: 25 29 31 491.22-491.24CNG-491.27 591.22-591.27
<b>0907339</b>  <b>A</b>	<b>42535445</b>	l=100 p=24 D=67 d=15	
<b>0809925</b>  <b>A</b>	<b>5006305890</b>	L=545 T=46 l=130 d=19	IRISBUS: EURORIDER
<b>0907259</b>  <b>A</b>	<b>42488722</b> 2969844	l=130 p=30 D=70 d=19	
<b>0809924</b>  <b>A</b>	<b>5006305892</b>	L=550 T=46 l=130 d=19	IRISBUS: EURORIDER
<b>0907259</b>  <b>A</b>	<b>42488722</b> 2969844	l=130 p=30 D=70 d=19	
<b>0807213</b>  <b>A</b>	<b>98488010</b>	L=583  d=19	CITYCLASS: 491.22/.24/.27 591.22/.24/.27
<b>0907259</b>  <b>A</b>	<b>42488722</b> 2969844	l=130 p=30 D=70 d=19	
<b>0807210</b>  <b>A</b>	<b>4738069</b>	L=730	370S/24/25L/30/35 370S/E27/E29/E35  Sospensioni anteriori (Front suspension)

## BARRE DI REAZIONE - TORQUE RODS

RIF. OCAP OCAP REF.	RIF. ORIG O.E. NUMBER	NOTE REMARKS	MODELLO / DESCRIZIONE MODEL / DESCRIPTION
<b>0907210</b> 	-	D=80	
<b>0907586</b> 	<b>093161371</b> 0005861533	D=65	senza perno (without pin)
<b>0809921</b> 	<b>5006305888</b>	L=760 T=46 l=130 d=19	IRISBUS: EURORIDER IRIZAR: PB
<b>0907259</b> 	<b>42488722</b> 2969844	l=130 p=30 D=70 d=19	

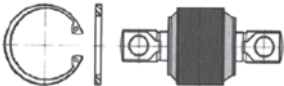
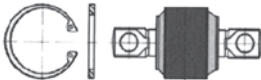
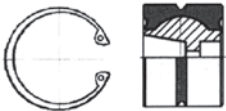

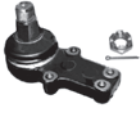

**KIT DI SOSPENSIONE - SUSPENSION KITS**

RIF. OCAP OCAP REF.	RIF. ORIG O.E. NUMBER	NOTE REMARKS	MODELLO / DESCRIZIONE MODEL / DESCRIPTION
<b>0907339</b> 	<b>42535445</b>	l=100 p=24 D=67 d=15	CITYCLASS
<b>0907362</b> 	<b>5001850588</b> 5000333285 5001860300 5010393047 42536819	l=130  D=85 d=19	BUS URBANWAY - IRISBUS: ACCESS-AXER-ARWAY-CITELIS
<b>0907327</b> 	<b>93192361</b>	l=130 p=24 D=62 d=19	EURORIDER - CITYCLASS
<b>0907583</b> 	<b>42530929</b>	l=145 p=30  d=21	CITYCLASS
<b>0907260</b> 	<b>93194458</b>	D=80	EURORIDER
<b>0907259</b> 	<b>42488722</b> 2969844	l=130 p=30 D=70 d=19	IRISBUS: ACCESS - ARWAY CITELIS - CROSSWAY EVADYS - EURORIDER

**SNODI SOSPENSIONI - SUSPENSION JOINTS**

RIF. OCAP OCAP REF.	RIF. ORIG O.E. NUMBER	NOTE REMARKS	MODELLO / DESCRIZIONE MODEL / DESCRIPTION
<b>0409919</b> 	<b>5010556210</b> 504201479 5801208436	L=198 M=36X1,5 RHT	IRISBUS: ARWAY-CROSSWAY-EVADYS-MAGELYS- RECREO

**STABILIZZATORI - STABILIZERS**

RIF. OCAP OCAP REF.	RIF. ORIG O.E. NUMBER	NOTE REMARKS	MODELLO / DESCRIZIONE MODEL / DESCRIPTION
<b>0507888</b> 	<b>5010199642</b>	L=195	IRIS BUS
<b>0589922</b> 	<b>5801893542</b> 5006306002	L=167 T=31	IRISBUS: DOMINO IRIZAR: PB
<b>0599922</b> 	<b>5006306003</b> 5801893544	L=167 T=31	IRISBUS: DOMINO IRIZAR: PB
<b>0858055</b> 	<b>5006306531</b>	L=1065 T=42	IRISBUS: EURORIDER BARRA STABILIZZATRICE - STABILIZER BAR



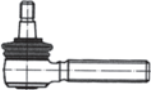

**TESTE COMANDO CAMBIO - GEAR CONTROL BALL JOINTS**

RIF. OCAP OCAP REF.	RIF. ORIG O.E. NUMBER	NOTE REMARKS	MODELLO / DESCRIZIONE MODEL / DESCRIPTION
<b>0187228</b>  	<b>86027074</b> 7981909 42487482	L=85  M=14 x 1,5 RH	AP 160 > 370 SE.27 75-9A 80-13.ABP/A2/A3 80-16A4 90-13A 110-13A/16A 130-13A/16A

**COMPONENTI - COMPONENTS**



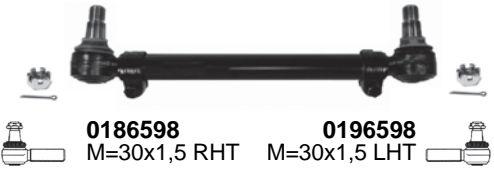
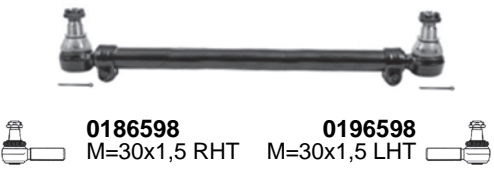

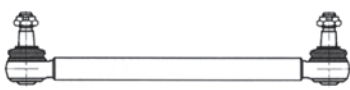

RIF. OCAP OCAP REF.	RIF. ORIG O.E. NUMBER	NOTE REMARKS	MODELLO / DESCRIZIONE MODEL / DESCRIPTION
<p><b>1216307</b></p> 	<p><b>5006305917</b></p>		<p>IRISBUS: EURORIDER BOCCOLA BARRA STABILIZZATRICE STABILIZER BAR BUSH</p>
<p><b>1216308</b></p> 	<p><b>500345518</b></p>		<p>IRISBUS: EURORIDER BOCCOLA BARRA STABILIZZATRICE STABILIZER BAR BUSH</p>

**BARRE ACCOPPIAMENTO - TIE RODS**



RIF. OCAP OCAP REF.	RIF. ORIG O.E. NUMBER	NOTE REMARKS	MODELLO / DESCRIZIONE MODEL / DESCRIPTION
<p><b>0507957</b></p> 	<p><b>81467116771</b> 81467116780 81467116877 81467116878 81467116879 81467116972</p>	<p>L=413 T=30</p>	<p>LION'S COACH-LION'S STAR - UL</p>
<p><b>0507954</b></p> 	<p><b>81467116886</b> 81467116897 81467116898 81467116899</p>	<p>L=429 T=36</p>	<p>HOCL 24.440 - 24.460 - 24.480</p>
<p><b>0507950</b></p>  <p><b>0186598</b> M=30x1,5 RHT    <b>0196598</b> M=30x1,5 LHT</p>	<p><b>81467106080</b> 81467106136 81467106172 81467106295 81467106337 81467106345 81467106421 81467106451 81467106876 81467116762</p>	<p>L=501 T=40</p>	<p>LION S COACH - STAR - UL</p>
<p><b>0507743</b></p>  <p><b>0186598</b> M=30x1,5 RHT    <b>0196598</b> M=30x1,5 LHT</p>	<p><b>81467116770</b> 81467116772 81467116874 81467116875 81467116876</p>	<p>L=660 T=36</p>	<p>HOCL - LION S COACH-STAR - UL - RH</p>
<p><b>0507407</b></p> 	<p><b>81467116765</b> 81467106453 81467106457 81467106458 81467106875 81467106881 81467116766 81467116767</p>		<p>LIONS S STAR - S COACH - R - 362 - 332 - 263</p>
<p><b>0507806</b></p> 	<p><b>81467106877</b> 81467106875 81467106444 81467106419 81467106081 81467106173 81467106137 81467106294 81467106879 81467116759</p>	<p>L=729</p>	<p>LION'S COACH FRH: FRH 362-R R/FR/FRH 292 SG SG 220-SG 240 HU-SG 242 H SG SG 240 H-SG 242-SG 242 H SG SG 240 H-SG 292 H-SG SG 242 SG 292-SG SG 312-SG 322 SL IISL 202-SL SL 200- SR SR 240 /280 SR 280 H-SR SR 321 H-SU SU 240/242/272/322 UL UL 313/353 - LION'S STAR</p>















**BARRE ACCOPPIAMENTO - TIE RODS**

RIF. OCAP OCAP REF.	RIF. ORIG O.E. NUMBER	NOTE REMARKS	MODELLO / DESCRIZIONE MODEL / DESCRIPTION
<p><b>0507848</b></p>  <p><b>0186598</b> M=30x1,5 RHT    <b>0196598</b> M=30x1,5 LHT</p>	<p><b>81466106579</b> 81466106580 81466106583 81466106624 81466106640 81467116720</p>	L=1530	SG SG: 220-240-242
<p><b>0507534</b></p>  <p><b>0186424</b> M=30x1,5 RHT    <b>0196424</b> M=30x1,5 LHT</p>	<p><b>81467106316</b> 81467106314 81467106315</p>	L=1545 T=38	HOCL
<p><b>0507817</b></p>  <p><b>0186598</b> M=30x1,5 RHT</p>	<p><b>81467106912</b></p>	L=1588	LION'S COACH - LION'S STAR
<p><b>0507840</b></p>  <p><b>0186613</b> M=28x1,5 RHT    <b>0196613</b> M=28x1,5 LHT</p>	<p><b>81467106852</b> 81467106851 81467106395 81467116719</p>	L=1620	L 2000: 8.150-8.220 10.150-10.220
<p><b>0507811</b></p>  <p><b>0186598</b> M=30x1,5 RHT</p>	<p><b>81467116722</b> 81467106902</p>	L=1676 T=50	UL 242-272-292-312-322
<p><b>0507824</b></p>  <p><b>0187843</b> M=30x1,5 RHT</p>	<p><b>81467106974</b> 81467116712 81467106862 81467106863 81467106864 81467106909 81467106910 81467116845</p>	L=1689 T=50	EL-NG-NL-NM





**BARRE ACCOPPIAMENTO - TIE RODS**

RIF. OCAP OCAP REF.	RIF. ORIG O.E. NUMBER	NOTE REMARKS	MODELLO / DESCRIZIONE MODEL / DESCRIPTION
<p><b>0507894</b></p>  <p><b>0187894</b> M=30x1,5 RHT</p>	<p><b>81467116715</b></p>	<p>L=1702</p>	<p>NG - NL - NU</p>
<p><b>0507742</b></p>  <p><b>0186424</b> M=30x1,5 RHT</p>	<p><b>81467106908</b> 81467106818 81467106459 81467106806 81467106819</p>	<p>L=1725 T=50</p>	<p>NG - NL</p>

**TIRANTI LONGITUDINALI - DRAG LINKS**

RIF. OCAP OCAP REF.	RIF. ORIG O.E. NUMBER	NOTE REMARKS	MODELLO / DESCRIZIONE MODEL / DESCRIPTION
<b>0507791</b> 	<b>81466116045</b> 81466106795 81466116047 81466116049 81466116115 81466116126	L=628 T=40	LION S CITY - NG-NL-NU
<b>0507818</b>   <b>0186613</b> M=28x1,5 RHT	<b>81466106305</b>	L=785	G 8 - G 9 - G 90
<b>0509920</b>   <b>0186598</b> M=30x1,5 RHT	<b>81466106708</b> 81466116067	L=905 T=52	HOCL-L 2000-NL-SU
<b>0507955</b>   <b>0186598</b> M30x1,5 RHT <b>0196598</b> M30x1,5 LHT 	<b>81466106374</b> 81466116019 82466106080 82466106189 82466106190	L=1050 T=42	NG-NL-NM
<b>0507809</b>   <b>0186598</b> M=30x1,5 RHT	<b>81466106711</b> 81466106785 81466116043 81466116081	L=1059 T=52	HOCL - NL
<b>0507549</b>   <b>0287907</b> M=52x1,5 RHT	<b>81466116017</b> 81466106706	L=1066 T=60	HOCL 18.220

TIRANTI LONGITUDINALI - DRAG LINKS

RIF. OCAP OCAP REF.	RIF. ORIG O.E. NUMBER	NOTE REMARKS	MODELLO / DESCRIZIONE MODEL / DESCRIPTION
<p><b>0507410</b></p>  <p><b>0187410</b> M=30x1,5 RHT</p>	<p><b>36466106012</b> 36466106040 81466116217 83466106001 83466106501</p>	<p>L=1103 T=50</p>	<p>HOCL - SU - LION S CITY</p>
<p><b>0507204</b></p>  <p><b>0187410</b> M=30x1,5 RHT</p>	<p><b>81466106648</b> 81466116150</p>	<p>L=1145 T=50</p>	<p>HOCL</p>
<p><b>0507685</b></p>  <p><b>0287907</b> M=52x1,5 RHT</p>	<p><b>81466106375</b> 81466106684 81466116016</p>	<p>L=1260 T=60</p>	<p>EL - NG - NL</p>
<p><b>0507212</b></p>  <p><b>0186598</b> M=30x1,5 RHT</p>	<p><b>81466106606</b></p>	<p>L=1270 T=48</p>	<p>HOCL</p>
<p><b>0507952</b></p>  <p><b>0186758</b> M=30x1,5 RHT</p>	<p><b>36466106007</b> 36466106033 81466106794 81466116044 81466116085 81466116108 81466116114 81466116120</p>	<p>L=1358 T=52</p>	<p>NG - NL - NU</p>









**TESTE STERZO - TIE RODS END**

RIF. OCAP OCAP REF.	RIF. ORIG O.E. NUMBER	NOTE REMARKS	MODELLO / DESCRIZIONE MODEL / DESCRIPTION
<b>0186424</b>  	<b>81953016239</b> 81953016250 81953010064 81953010014 81953016162 81953016067 90804153111	L=115  M=30x1,5 RHT	EM/NM: 222-223 - NL - NL 202
<b>0196424</b>  	<b>81953010074</b> 81953010013 81953016163 81953016068 90804153107 90804153113	L=115  M=30x1,5 LHT	EM/NM 222-223
<b>0186598</b>  	<b>81953016234</b> 81953016278 81953016242 81953016108 81953016112 81953010016 81953016048 81953016049 81953016053 81953016126 81953016090 81953016143 81953016149 81953016154 81953016156 81953016194 81953016274 81953016178 81953016224 81953010084	L=120  M=30x1,5 RHT	EL - EM - FRH - NG - NL NM - SG - SL - SR LION'S STAR - LION'S COACH
<b>0196598</b>  	<b>81953016237</b> 81953016279 81953010015 81953010087 81953016030 81953016043 81953016050 81953016054 81953016087 81953016125 81953016091 81953016107 81953016120 81953016152 81953016155 81953016157 81953016168 81953016179 81953016275 81953016223	L=120  M=30x1,5 LHT	EL - EM - FRH - NG - NL NM - SG - SL - SR LION'S STAR - LION'S COACH









**TESTE STERZO - TIE RODS END**

RIF. OCAP OCAP REF.	RIF. ORIG O.E. NUMBER	NOTE REMARKS	MODELLO / DESCRIZIONE MODEL / DESCRIPTION
<b>0186758</b> 	<b>81953010022</b> 0696226 0609643 0586714 0609634 0607073 1337367	L=135  M=30x1,5 RHT	EL - EM - LION'S STAR - FRH - RH NG - NL - NM - SG - SL - SR - SU
<b>0187843</b> 	<b>81953016270</b>	L=141  M=30x1,5 RHT	EL EL 202-222-262 NG NG 262-63-272-312-313 NM NM 152
<b>0187894</b> 	<b>81953016271</b> 81953016325	L=145  M=30x1,5 RHT	NG - NL - NU
<b>0187410</b> 	<b>81953016355</b> 81953010089 81953016345	L=155 M=30x1,5 RHT	HOCL - SU - LION S CITY
<b>0287907</b> 	<b>81953016233</b> 81953016255 81953016277 0004606748	L=168  M=52x1,5 RHT	EL - NG - NL - HOCL 18.220

BARRE DI REAZIONE - TORQUE RODS







RIF. OCAP OCAP REF.	RIF. ORIG O.E. NUMBER	NOTE REMARKS	MODELLO / DESCRIZIONE MODEL / DESCRIPTION
<b>0807816</b> 	<b>81432206177</b> 81432206179 81432206224	L=330 T=36	LION S COACH - STAR
<b>0807806</b> 	<b>81432206164</b> 81432206165 81432206166 81432206215 81432206227 81432206228	L=413  d=15 l=80	LION S CITY - NG-NL-NM-NU
<b>0807819</b>  <b>0907407</b> 	<b>81432206248</b> 81432206251 81432206254 81432206256  <b>85432206002</b> 500333284 0003302011	L=470 T=48 l=130 d=19	HOCL - LION S CITY-COACH-STAR
<b>0807808</b>  <b>0907259</b> 	<b>81432206145</b> 81432206208 81432206209 81432206162 81432206160  <b>81432206055</b> 81432206073 81432206107 81432206104	L=531 T=48  l=130 p=30 D=70 d=19	LION S CITY - NG-NL-NM-NU
<b>0807821</b>  <b>0907259</b> 	<b>81432206161</b> 81432206190  <b>81432206055</b> 81432206073 81432206107 81432206104	L=531 T=50 l=130 d=19  l=130 p=30 D=70 d=19	NG - NL - NU
<b>0807823</b> 	<b>81432206151</b> 81432206183 81432206276	L=570 T=48 l=130 d=19	HOCL - LION S COACH-STAR - UL

BARRE DI REAZIONE - TORQUE RODS





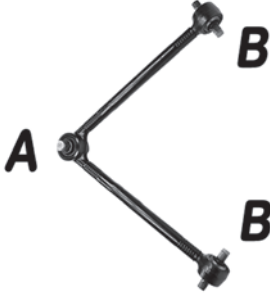



RIF. OCAP OCAP REF.	RIF. ORIG O.E. NUMBER	NOTE REMARKS	MODELLO / DESCRIZIONE MODEL / DESCRIPTION
<p><b>0907259</b></p> <p><b>A</b> </p>	<p><b>81432206055</b> 81432206073 81432206107 81432206104</p>	<p>L=130 p=30 D=70 d=19</p>	
<p><b>0807832</b></p> <p><b>A</b>  <b>A</b></p>	<p><b>81432206258</b> 81432206264 81432206275 81432206278 81432206279</p>	<p>L=622 T=48 l=130 d=19</p>	HOCL - LION S COACH-STAR
<p><b>0907362</b></p> <p><b>A</b> </p>	<p><b>81432706127</b></p>	<p>l=130  D=85 d=19</p>	
<p><b>0807408</b></p> <p><b>A</b> </p>	<p><b>81432206396</b> 81432206409 81432206144 81432206210 81432206189 81432206211</p>	<p>L=614 T=48 l=130 d=19</p>	LION S CITY - NG - NL - NU
<p><b>0907259</b></p> <p><b>A</b> </p>	<p><b>81432206055</b> 81432206073 81432206107 81432206104</p>	<p>l=130 p=30 D=70 d=19</p>	
<p><b>0807409</b></p> <p><b>A</b>  <b>B</b></p>	<p><b>81432206112</b> 81432206123 81432206125 81432206127 81432206220</p>	<p>L=630 T=50</p>	LION S CITY - HOCL-NL
<p><b>0907259</b></p> <p><b>A</b> </p>	<p><b>81432206055</b> 81432206073 81432206107 81432206104</p>	<p>l=130 p=30 D=70 d=19</p>	
<p><b>0907409</b></p> <p><b>B</b> </p>	<p><b>81432206204</b></p>	<p>D=94</p>	
<p><b>0807410</b></p> <p><b>A</b>  <b>B</b></p>	<p><b>81432206187</b> 81432206234 81432206240</p>	<p>L=633 T=50</p>	LION S COACH - S STAR





**BARRE DI REAZIONE - TORQUE RODS**

RIF. OCAP OCAP REF.	RIF. ORIG O.E. NUMBER	NOTE REMARKS	MODELLO / DESCRIZIONE MODEL / DESCRIPTION
<p><b>0907259</b></p> <p><b>A</b> </p> <p><b>0907409</b></p> <p><b>B</b> </p>	<p><b>81432206055</b> 81432206073 81432206107 81432206104</p> <p><b>81432206204</b></p>	<p>I=130 p=30 D=70 d=19</p> <p>D=94</p>	
<p><b>0807822</b></p> <p><b>A</b>  <b>A</b></p> <p><b>0907259</b></p> <p><b>A</b> </p>	<p><b>81432206185</b> 81432206100 81432206099 81432206103 81432206113 81432206114 81432206143 81432206173</p> <p><b>81432206055</b> 81432206073 81432206107 81432206104</p>	<p>L=750 T=48 I=130 d=19</p> <p>I=130 p=30 D=70 d=19</p>	EL - NG - NL
<p><b>0807844</b></p> <p><b>A</b>  <b>B</b></p> <p><b>0907844</b></p> <p><b>A</b> </p> <p><b>0907845</b></p> <p><b>B</b> </p>	<p><b>81433156037</b> 81433156036</p> <p><b>81433150009</b></p> <p><b>81432706133</b> 5001847026</p>	<p>L=782 T=48</p> <p>I=145 p=35 D=95 d=19</p> <p>I=130 p=30 D=85 d=21</p>	LION S - COACH - STAR - CENTROLINER

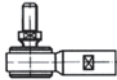

**KIT DI SOSPENSIONE - SUSPENSION KITS**

RIF. OCAP OCAP REF.	RIF. ORIG O.E. NUMBER	NOTE REMARKS	MODELLO / DESCRIZIONE MODEL / DESCRIPTION
<b>0907330</b> 	<b>81432706045</b> 81432706040	l=152 p=24 D=80 d=21	VARIO: O 810-O 812-O 814-O 815 - O 816
<b>0907362</b> 	<b>81432706127</b>	l=130  D=85 d=19	EL - NG - NL
<b>0907409</b> 	<b>81432206204</b>	D=94	BUS LION S CITY - HOCL-NL
<b>0907259</b> 	<b>81432206055</b> 81432206073 81432206107 81432206104	l=130 p=30 D=70 d=19	LION'S COACH LION'S STAR EL - NG - NL - NU - SL VARIO
<b>0907528</b> 	<b>81432306051</b>	l=115 p=24 D=62 d=17	UL 242 - 272 - 292 - 312 - 322
<b>0907407</b> 	<b>85432206002</b> 500333284 0003302011		HOCL - LION S CITY-COACH-STAR
<b>0907844</b> 	<b>81433150009</b>	l=145 p=35 D=95 d=19	LION S - COACH - STAR
<b>0907845</b> 	<b>81432706133</b> 5001847026	l=130 p=30 D=85 d=21	LION S - COACH - STAR - CENTROLINER

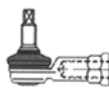
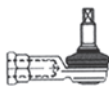









**TESTE COMANDO CAMBIO - GEAR BOX CONTROL BALL JOINTS**

RIF. OCAP OCAP REF.	RIF. ORIG O.E. NUMBER	NOTE REMARKS	MODELLO / DESCRIZIONE MODEL / DESCRIPTION
<b>0287294</b>  	<b>90804105207</b>	L=35  M=10x1	CENTROLINER
<b>0187228</b>  	<b>81953010038</b> 81953016169 81953016172 81953016176 81953016266 81953016235 81953016302	L=85  M=14 x 1,5 RH	R FRH 362-R R 292 FR 292-FRH 292 SG SG 220-SG 242 SL SL 200 SR SR 240/280 SU SU 240/242/272/292/322
<b>0287229</b>  	<b>81953016064</b> 81953016130 81953016170 81953016173	L=55  M=12x1,75 RH	EL - EM - LION'S COACH-LION'S STAR NG - NL . NM - MU - R FRH SG - SL - SR - SU -UL
<b>0297229</b>  	<b>81953016063</b> 81953016131 81953016171 81953016174	L=55  M=12x1,75 LH	EL - EM - LION'S COACH-LION'S STAR NG - NL . NM - MU - R FRH SG - SL - SR - SU -UL

**KIT PERNO FUSO - KING PIN SET**

RIF. OCAP OCAP REF.	RIF. ORIG O.E. NUMBER	NOTE REMARKS	MODELLO / DESCRIZIONE MODEL / DESCRIPTION
<p><b>0927406</b></p> 	<p><b>81.44205.6009</b>                      81.44204.0008                      81442050041 (1)                      81930200708 (2)                      81930200707 (3)                      06328190016 (4)                      - (5)                      06290200130 (6)                      06563414505 (7)                      06562790278 (8)                      81907110940 (9)                      06380702202 (10)</p>	<p>L=213  D=44,5/45</p>	<p>SL200 SR240 SU240</p>
<p><b>0927408</b></p> 	<p><b>81.44205.6013</b></p>	<p>L=223  D=49,5/50</p>	<p>EL 202-222-262 LION'S COACH - LION'S STAR NG 262-263-272-312 NM 152 NL 202-262-263-312 UL 242-272-292-312-313-322 SD 202 - SG 240-242-292 SL 202 - SU 240</p>





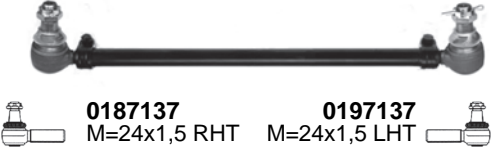
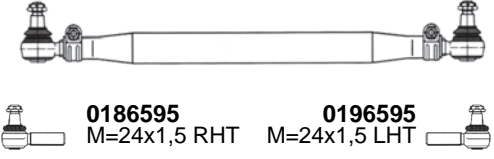
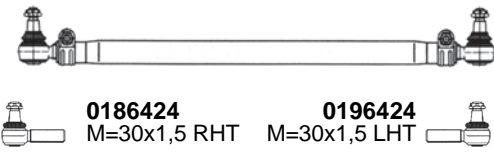
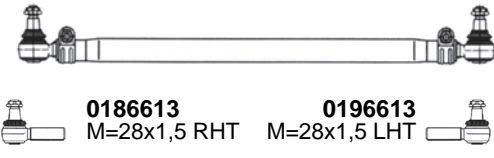
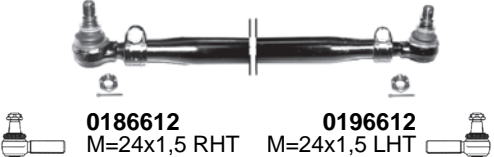
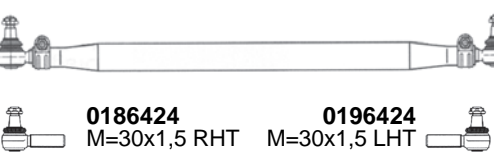

**BARRE ACCOPPIAMENTO - TIE RODS**

RIF. OCAP OCAP REF.	RIF. ORIG O.E. NUMBER	NOTE REMARKS	MODELLO / DESCRIZIONE MODEL / DESCRIPTION
<p><b>0507433</b></p> 	<p><b>0003201232</b> 6283201489 6293200189 6323200232 6323200532</p>	<p>L=200</p>	<p>BUS INTEGRO O 550 - TRAVEGO O 580 CITARO O 530 - CONECTO O 345</p>
<p><b>0507421</b></p> 	<p><b>6273300103</b> 8226330000 8226330000C</p>		<p>SETRA 200 S - 300 S</p>
<p><b>0507429</b></p> 	<p><b>6273300303</b> 8226347000 8226247000C</p>	<p>L=484 T=40</p>	<p>EVOBUS: KASSBOHRER - SETRA 300</p>
<p><b>0507425</b></p>  <p> <b>0287881</b> M=30x1,5 RHT</p>	<p><b>4103300303</b> 4103300503 8226248000C 8226308000 8226308000C 8226381000</p>	<p>L=630 T=38</p>	<p>EVOBUS: KASSBOHRER - SETRA 300-400</p>
<p><b>0502259</b></p>  <p> <b>0182259</b> M=24x1,5 RHT</p>	<p><b>6313300603</b></p>	<p>L = 668</p>	<p>100 City</p>
<p><b>0507424</b></p>  <p> <b>0187146</b>      <b>0197146</b>  M=30x1,5 RHT      M=30x1,5 LHT</p>	<p><b>6344600505</b> 8226244000D 8226258000C 8226306000</p>	<p>L=670 T=40</p>	<p>SETRA 400</p>
<p><b>0507423</b></p> 	<p><b>6273300203</b> A6273300203 82263260000 82263280000</p>		<p>SETRA 300 S</p>







**BARRE ACCOPPIAMENTO - TIE RODS**

RIF. OCAP OCAP REF.	RIF. ORIG O.E. NUMBER	NOTE REMARKS	MODELLO / DESCRIZIONE MODEL / DESCRIPTION
<p><b>0507600</b></p>  <p><b>0187137</b> M=24x1,5 RHT    <b>0197137</b> M=24x1,5 LHT</p>	<p><b>3563300003</b> 6133300003</p>	<p>L=697 T=32</p>	<p>O 403 - O 404 - O 405 - TOURISMO O 350</p>
<p><b>0507786</b></p>  <p><b>0186595</b> M=24x1,5 RHT    <b>0196595</b> M=24x1,5 LHT</p>	<p><b>3163300603</b> 3163300203 3163300503 3163300703</p>	<p>L=1454</p>	<p>LP LPO: 608-709</p>
<p><b>0507792</b></p>  <p><b>0186424</b> M=30x1,5 RHT    <b>0196424</b> M=30x1,5 LHT</p>	<p><b>6763300803</b> 6763301003 673300503 6763300303</p>	<p>L=1546</p>	<p>L/LN2: 814F/L/S-817/F/LS/S-914/K/KO-917/K/KO 1114/K/L/S-1117/K/LS/S-1120/F/L/LS/S 1124/F-1317/K O 301 - O 402</p>
<p><b>0507790</b></p>  <p><b>0186613</b> M=28x1,5 RHT    <b>0196613</b> M=28x1,5 LHT</p>	<p><b>6763300703</b> 6763300203 6763300403 6763300603 6763300903</p>	<p>L=1550</p>	<p>814 O-814 LO 817 O-817 LO</p>
<p><b>0507653</b></p>  <p><b>0186612</b> M=24x1,5 RHT    <b>0196612</b> M=24x1,5 LHT</p>	<p><b>6703300203</b> 6703300303</p>	<p>L=1594</p>	<p>O 609 D- O 611 D- O 614 D ATEGO BUS VARIO O 810-O 812-O 814-O 815</p>
<p><b>0507657</b></p>  <p><b>0186424</b> M=30x1,5 RHT    <b>0196424</b> M=30x1,5 LHT</p>	<p><b>3853301403</b></p>	<p>L=1611</p>	<p>KASSB. EVOBUS</p>

**BARRE ACCOPPIAMENTO - TIE RODS**

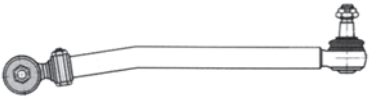

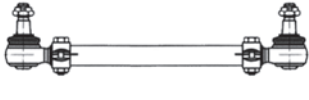



RIF. OCAP OCAP REF.	RIF. ORIG O.E. NUMBER	NOTE REMARKS	MODELLO / DESCRIZIONE MODEL / DESCRIPTION
<p><b>0507654</b></p>  <p><b>0186424</b> M=30x1,5 RHT</p>	<p><b>3023301803</b> 3023300303 3023300603</p>	L=1622	O 302
<p><b>0507644</b></p>  <p><b>0186424</b> M=30x1,5 RHT</p>	<p><b>3573300803</b> 3573300903 3573301403</p>	L=1689	O 405-O 405 ST-O 405 N-O 405 G O 405 GN-O 405 GTD
<p><b>0507619</b></p>  <p><b>0287136</b> M=35x1,5 RHT    <b>0297136</b> M=35x1,5 LHT</p>	<p><b>3573301103</b> 3573301503 6713300003 3053300403 3053300803 3053301003</p>	L=1705 T=40	O 405
<p><b>0507742</b></p>  <p><b>0186424</b> M=30x1,5 RHT</p>	<p><b>3573300603</b> 3573300703</p>	L=1725 T=50	O 405 O 405 G-GN-N-ST
<p><b>0507435</b></p>  <p><b>0187435</b> M=30x1,5 RHT</p>	<p><b>3823300403</b> 6283300003 6283300103</p>	L=1733 T=62	CITARO O 530
<p><b>0507616</b></p>  <p><b>0287136</b> M=35x1,5 RHT    <b>0297136</b> M=35x1,5 LHT</p>	<p><b>3573300503</b> 3573300203 3573300403 3573301603</p>	L=1740 T=40	O 405 - O 407 - O 408

TIRANTI LONGITUDINALI - DRAG LINKS

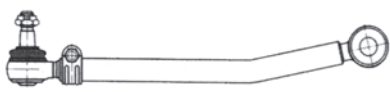
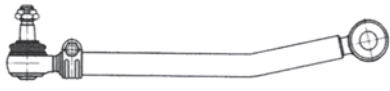





RIF. OCAP OCAP REF.	RIF. ORIG O.E. NUMBER	NOTE REMARKS	MODELLO / DESCRIZIONE MODEL / DESCRIPTION
<p><b>0507606</b></p>  <p><b>0187342</b> M=24x1,5 RHT</p>	<p><b>3134600005</b> 3134600105</p>	<p>L=490 T=28</p>	<p>O 309 - T2/L</p>
<p><b>0507659</b></p>  <p><b>0186613</b> M=28x1,5 RHT</p>	<p><b>6704602605</b> 6704602705</p>	<p>L=495</p>	<p>O 611- O 614</p>
<p><b>0507624</b></p>  <p><b>0186613</b> M=28x1,5 RHT</p>	<p><b>6704602805</b> 6704602905</p>	<p>L=495 T=32</p>	<p>O 611- O 614</p>
<p><b>0507898</b></p>  <p><b>0186613</b> M=28x1,5 RHT</p>	<p><b>6704602205</b> 6704601805 6704600905</p>	<p>L=505 T=32</p>	<p>T2/LN1 O 609 D Per veicoli con guida a destra For RHD vehicles only</p>
<p><b>0507144</b></p> 	<p><b>3563300103</b> 6133300103</p>	<p>Lt=506</p>	<p>O 350 - O 404</p>
<p><b>0507140</b></p>  <p><b>0186424</b> M=30x1,5 RHT</p>	<p><b>3004600205</b> 3004600305 3014600005 3014600105</p>	<p>L=658</p>	<p>O 303-O 305-O 305G-O 307</p>









TIRANTI LONGITUDINALI - DRAG LINKS

RIF. OCAP OCAP REF.	RIF. ORIG O.E. NUMBER	NOTE REMARKS	MODELLO / DESCRIZIONE MODEL / DESCRIPTION
<p><b>0506581</b></p>  <p><b>0187146</b> M=30x1,5 RHT</p>	<p><b>6754602405</b> 6754601205 6754601805 6754603005</p>	L=727	O 817-O 1114-O 1117-O 1120
<p><b>0506576</b></p>  <p><b>0187146</b> M=30x1,5 RHT</p>	<p><b>6754602205</b> 6754601005 6754601605 6754602805</p>	L=780	O 1114-O 1117-O 1120 O1320 G.Sn/LHD
<p><b>0506577</b></p>  <p><b>0187146</b> M=30x1,5 RHT</p>	<p><b>6764601105</b> 6764600105 6764600605 6764601505</p>	L=780	O 1120 L G.Sn./LHD O 1114-O 1117
<p><b>0507428</b></p>  <p><b>0186551</b> M=30x1,5 RHT</p>	<p><b>4103300205</b> 8226380000 8226380000C</p>	L=870 T=38	SETRA 300 S - 400 S
<p><b>0507426</b></p> 	<p><b>3574603205</b> 3574602505 6714600105 6714600305 A3574603205</p>	L=920 T=36	O 405 - CONECTO O 345
<p><b>0507430</b></p> 	<p><b>6284600305</b> 6284601205 A6284600305 A6284601205</p>	L=928 T=42	CITARO O 530 - CONECTO O 345
<p><b>0507139</b></p>  <p><b>0186424</b> M=30x1,5 RHT</p>	<p><b>3004600605</b> 3004600705 3054600305</p>	L=975	O 303-O 305-O 305 G/ST-O 307 KASSB. EVOBUS









TIRANTI LONGITUDINALI - DRAG LINKS

RIF. OCAP OCAP REF.	RIF. ORIG O.E. NUMBER	NOTE REMARKS	MODELLO / DESCRIZIONE MODEL / DESCRIPTION
<p><b>0507143</b></p>  <p><b>0186424</b> M=30x1,5 RHT</p>	<p><b>3734601005</b> 3734600705 3734600505</p>	<p>L=976</p>	<p>O 340</p>
<p><b>0507141</b></p>  <p><b>0186424</b> 30x1,5 RHT</p>	<p><b>3574601005</b> 3574601105</p>	<p>L=988</p>	<p>O 405-O 407-O 408</p>
<p><b>0507438</b></p>  <p><b>0186424</b> M=30x1,5 RHT    <b>0196598</b> M=30x1,5 LHT</p>	<p><b>3564600205</b> 3574602205</p>	<p>L=1007 T=38</p>	<p>O 404 - O 405</p>
<p><b>0507645</b></p>  <p><b>0186424</b> M=30x1,5 RHT</p>	<p><b>3574601405</b> 3574601505</p>	<p>L=1066</p>	<p>O 405-O 407-O 408</p>
<p><b>0507138</b></p>  <p><b>0186424</b> M=30x1,5 RHT</p>	<p><b>3004600405</b> 3004600505</p>	<p>L=1146</p>	<p>O 303 - O 340 Turismo KASSB. EVOBUS</p>
<p><b>0507422</b></p>  <p><b>0186598</b> M=30x1,5 RHT    <b>0196598</b> M=30x1,5 LHT</p>	<p><b>3574602405</b> 3574603105 6714600005 6714600205 A3574602405 A3574603105</p>	<p>L=1160 T=38</p>	<p>O 405 - CONECTO O 345</p>

TIRANTI LONGITUDINALI - DRAG LINKS

RIF. OCAP OCAP REF.	RIF. ORIG O.E. NUMBER	NOTE REMARKS	MODELLO / DESCRIZIONE MODEL / DESCRIPTION
<p><b>0507142</b></p>  <p><b>0186424</b> M=30x1,5 RHT</p>	<p><b>3574601205</b> 3054600605 3574601305</p>	<p>L=1160</p>	<p>O 307 O407 O 408</p>
<p><b>0507685</b></p>  <p><b>0287907</b> M=52x1,5 RHT</p>	<p><b>3574602005</b> 3574602305</p>	<p>L=1260 T=60</p>	<p>O 405</p>
<p><b>0507432</b></p>  <p><b>0186598</b> M=30x1,5 RHT</p>	<p><b>6284600205</b> 6284601105 A6284600205</p>	<p>L=1271 T=60</p>	<p>CITARO O 530 - CONECTO O 345</p>
<p><b>0507431</b></p>  <p><b>0186598</b> M=30x1,5 RHT    <b>0196598</b> M=30x1,5 LHT</p>	<p><b>3574603505</b> A3574603505 9423301003 9423301703 9423302503</p>	<p>L=1280 T=38</p>	<p>ACTROS MP2 - AXOR 2 - BUS O 405</p>
<p><b>0507652</b></p>  <p><b>0180729</b> M=24x1,5 RHT    <b>0190729</b> M=24x1,5 LHT</p>	<p><b>3093301903</b> 3093301203 3093301403 3093301603 3093301703 3093301803 3093302003 3093302103</p>	<p>L=1476</p>	<p>O 309 KASSB. EVOBUS</p>
<p><b>0507427</b></p> 	<p><b>6264600005</b> 8226355000 82262800000 82263550000 8226280000B 8226280000C</p>		<p>EVOBUS S 310</p>







**TESTE STERZO - TIE RODS END**

RIF. OCAP OCAP REF.	RIF. ORIG O.E. NUMBER	NOTE REMARKS	MODELLO / DESCRIZIONE MODEL / DESCRIPTION
<b>0281904</b>  	<b>6384600048</b>	L=75  M=16x1,5 RHT	VITO Bus SPRINTER Bus
<b>0287361</b>  	<b>0004634429</b> 0009964845 0014607048 A0004634429 A0009964845	L=75  M=26x1,5 RHT	INTEGRO O 550 - TOURISMO O 350 - TRAVEGO O 580
<b>0281503</b>  	<b>9014600348</b> 9014600048 9014600148	L=76  M=16x1,5 RHT	SPRINTER Bus
<b>0287360</b>  	<b>0014606948</b>	L=90  M=26x1,5 RHT	INTEGRO O 550 - TOURISMO O 350 - TRAVEGO O 580
<b>0182260</b>  	<b>0013304835</b> 0004607248 4603300435 4603301235 4603301335 6313380510	L=95  M=20x1,5 RHT	100 O 100 City
<b>0182261</b>  	<b>0004606548</b>	L=95  M=18x1,5 RHT	O 100 City
<b>0180730</b>  	<b>3103301335</b> 0004608548 0004604148 0003305035 0004602148 0004604548 0004604348	L=95  M=22x1,5 RHT	O 309 T1: 601-602
<b>0186612</b>  	<b>0003309735</b> 0003309935 0003301235 0003307535 0003383429 0003383529	L=105  M=24x1,5 RHT	O 609 D-O 611 D-O 624 D-O 811 D VARIO: O 810-O 812 KASSB. EVOBUS
<b>0196612</b>  	<b>0003309835</b> 0003301335	L=105  M=24x1,5 LHT	O 609 D-O 611 D-O 614 D-O 811 D KASSB. EVOBUS



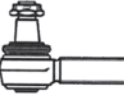

TESTE STERZO - TIE RODS END

RIF. OCAP OCAP REF.	RIF. ORIG O.E. NUMBER	NOTE REMARKS	MODELLO / DESCRIZIONE MODEL / DESCRIPTION
<b>0186613</b> 	<b>0003309335</b> 0003301435 0003301535 0003307135 0003309535 0003382129 0003383629	L=105  M=28x1,5 RHT	LK/LN2: 814 O-814 LO-817 O-817 LO O 609 D-O 611 D-O 614 D-811 D O 814-O 814 L-OF 1113 KASSB. EVOBUS
<b>0196613</b> 	<b>0003309435</b> 0003303335 0003307235 0003309635	L=105  M=28x1,5 LHT	LK/LN2: 814 O-814 LO-817 O-817 LO O 609 D-O 611 D-O 614 D-811 D O 814-O 814 L-OF 1113 KASSB. EVOBUS
<b>0187342</b> 	<b>0004604348</b> 0003381810 0003305635 0004605648 0004631129 6.851.488.000	L=105  M=24x1,5 RHT	O 309 D
<b>0197342</b> 	<b>6.851.489.000</b> 120326200	L=105  M=24x1,5 LHT	
<b>0186424</b> 	<b>6851516000</b> 0014603448 0013300235 0013300135 0004633529 0004633429 0004608348 0003383410 0003307335 0003305835 0003303235 0003300248	L=115  M=30x1,5 RH	O 301-O 303-O 305 O 305G-O307 O 1114-O 1114L/42 O1114L/49-O 1117L KASSB. EVOBUS (Ref.-No 6.851.512.000)
<b>0196424</b> 	<b>6851516000</b> 0013308835 0003300148 3023300035 3023300135 3023300235 3023300335	L=115  M=30x1,5 LHT	O 301-O 303-O 305 O 305G-O 307 O 1114-O 1114L/42 O1114L/49-O 1117L KASSB. EVOBUS(Ref-No. 6.851.516.000)
<b>0186547</b> 	<b>0013300335</b> 0013300435 0003303135 0003308135	L=115  M=30x1,5 RHT	LK/LN2 814 LO LK/LN2 817 LO LP LPO 608-709 O 301-O 402 O 814-O 814 L-O 817-O 817L OF 1113
<b>0287881</b> 	<b>6851529000</b> 68515290000 1315878	L=120  M=30X1,5 RHT	EVOBUS: KASSBOHRER - SETRA 300-400 SERIES



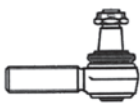





TESTE STERZO - TIE RODS END

RIF. OCAP OCAP REF.	RIF. ORIG O.E. NUMBER	NOTE REMARKS	MODELLO / DESCRIZIONE MODEL / DESCRIPTION
<b>0186598</b> 	<b>0004602848</b> 0004602248 6851484000 0004602948 6851475000 0014600248 6851531000 0004600348 0014600848 0014601248 0004608948 0014600948 0014602248	L=120  M=30x1,5 RHT	CITARO - INTEGRO - TRAVEGO O 303 - O 317 - O 404 - O 405 NEOPLAN: CENTROLINER - TOURLINER STARLINER - TRANSLINER - TRENDLINER
<b>0196598</b> 	<b>0004603448</b> 6851485000 0004600648 0004603548 6851476000 0004601248 0014601448 6851481000 0014600348 0014602348 0014603748	L=120  M=30x1,5 LHT	CITARO - INTEGRO - TRAVEGO O 303 - O 317 - O 404 - O 405 NEOPLAN: CENTROLINER - TOURLINER STARLINER - TRANSLINER - TRENDLINER
<b>0187137</b> 	<b>0004607748</b> 0014602148	L=120  M=24x1,5 RHT	O 350 O 404 O 405
<b>0197137</b> 	<b>0004607848</b> 0014602048	L=120  M=24x1,5 LHT	O 350 O 404 O 405
<b>0187146</b> 	<b>0004602648</b> 6851533000 0004600148 6851478000 0004602748 6851486000	L=120  M=30x1,5 RHT	KASSB. EVOBUS
<b>0197146</b> 	<b>6851532000</b> 6851523000 6851488000 6851486000 0014607448 0014607548	L=120  M=30x1,5 LHT	KASSB. EVOBUS
<b>0187467</b> 	<b>6.851.491.000</b>	L=135	KASSB. EVOBUS

**TESTE STERZO - TIE RODS END**









RIF. OCAP OCAP REF.	RIF. ORIG O.E. NUMBER	NOTE REMARKS	MODELLO / DESCRIZIONE MODEL / DESCRIPTION
<b>0197467</b>  	<b>6.851.490.000</b>	L=135  M=38x1,5 LHT	KASSB. EVOBUS
<b>0287136</b>  	<b>0013302135</b> 0013302635 0003304035 0003307735 0003384929 0003302835	L=140  M=35x1,5 RHT	O 302-O 303-O 305 O 305G-O 307-O 405 ST-O 405 G O 407 VE-O 408-O 1625 L-O 1628 L O 340 TOURISMO KASSB. EVOBUS
<b>0297136</b>  	<b>0013302235</b> 0013302735 0003304135 0003307835 0003385029 0003302935	L=140  M=35x1,5 LHT	O 302-O 303-O 305 O 305G-O 307-O 405 ST-O 405 G O 407 VE-O 408-O 1625 L-O 1628 L O 340 TOURISMO KASSB. EVOBUS
<b>0187435</b>  	<b>0014605648</b>		CITARO O 531
<b>0287907</b>  	<b>0004606748</b>	L=168  M=52x1,5 RHT	O 405 O 405 G-ST

**BARRE DI REAZIONE - TORQUE RODS**









RIF. OCAP OCAP REF.	RIF. ORIG O.E. NUMBER	NOTE REMARKS	MODELLO / DESCRIZIONE MODEL / DESCRIPTION
<b>0807418</b> 	<b>3173500606</b> 3573303411	L=585 T=56	O 303 - O 405
<b>0807882</b> 	<b>3573500306</b>	L=585	O 405 O - O 407 O - O 408 O
<b>0907882</b> 	<b>0003300080</b>	l=130 p=30 D=87 d=19	
<b>0907883</b> 	<b>0003301611</b>	L=70 D=87	
<b>0807593</b> 	<b>6283330405</b>	L=618 T=42	CITARO O 530
<b>0807594</b> 	<b>3573330405</b> 6713330105	L=625 T=36	O 405
<b>0807412</b> 	<b>6293501206</b> 6293500106 6293502806 4103500906	L=628 T=48	TRAVEGO O 580 - SETRA 400 - INTEGRO O 550
<b>0907259</b> 	<b>0003500506</b> 0003300611	l=130 p=30 D=70 d=19	











BARRE DI REAZIONE - TORQUE RODS

RIF. OCAP OCAP REF.	RIF. ORIG O.E. NUMBER	NOTE REMARKS	MODELLO / DESCRIZIONE MODEL / DESCRIPTION
<p><b>0807672</b></p>  <p><b>B</b> <b>B</b></p>	<p><b>3563331304</b></p>	<p>L=507</p> <p>d=15</p>	<p>O 350 TOURISMO O 404 O 405 G/GN/N/ST</p>
<p><b>0907672</b></p>  <p><b>B</b></p>	<p><b>0003501005</b></p>	<p>I=115 p=24 D=55 d=21</p>	
<p><b>0807413</b></p>  <p><b>A</b> <b>A</b></p>	<p><b>6273500006</b> 6273500106 6283330005 6283331005 6283331805</p>	<p>L=658 T=48</p>	<p>CITARO O 530 - CONECTO O 345 - INTEGRO O 550 SETRA 400</p>
<p><b>0907259</b></p>  <p><b>A</b></p>	<p><b>0003500506</b> 0003300611</p>	<p>I=130 p=30 D=70 d=19</p>	
<p><b>0807590</b></p>  <p><b>A</b> <b>A</b></p>	<p><b>6293500606</b> 8226293000B 6293500506</p>	<p>L=658 T=48 I=130 d=19</p>	<p>TRAVEGO O 580</p>
<p><b>0907259</b></p>  <p><b>A</b></p>	<p><b>0003500506</b> 0003300611</p>	<p>I=130 p=30 D=70 d=19</p>	
<p><b>0807591</b></p>  <p><b>A</b> <b>A</b></p>	<p><b>6283330205</b></p>	<p>L=659 I=115</p> <p>d=17</p>	<p>CITARO O 530 - CONECTO O 345</p>
<p><b>0907591</b></p>  <p><b>A</b></p>	<p><b>0003302111</b></p>	<p>I=115 p=24 D=67 d=17</p>	

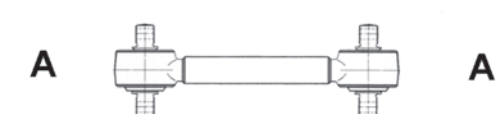

**BARRE DI REAZIONE - TORQUE RODS**

RIF. OCAP OCAP REF.	RIF. ORIG O.E. NUMBER	NOTE REMARKS	MODELLO / DESCRIZIONE MODEL / DESCRIPTION
<p><b>0807592</b></p>  <p><b>A</b></p>	<b>6283330305</b>	L=659 T=46  d=17	CITARO O 530
<p><b>0907591</b></p>  <p><b>A</b></p>	<b>0003302111</b>	l=115 p=24 D=67 d=17	
<p><b>0807420</b></p>  <p><b>A</b></p>	<b>8226232000</b> 8226241000 8226357000 6293520005	L=660 T=50	SETRA 200 S - KAESSBOHRER
<p><b>0907259</b></p>  <p><b>A</b></p>	<b>0003500506</b> 0003300611	l=130 p=30 D=70 d=19	
<p><b>0807415</b></p>  <p><b>A</b></p>	<b>8226323000B</b> 8226318000B 8.226.318.000B 8.226.323.000B	L=660 T=48	CONECTO O 345 - EVOBUS S 310
<p><b>0907259</b></p>  <p><b>A</b></p>	<b>0003500506</b> 0003300611	l=130 p=30 D=70 d=19	
<p><b>0807416</b></p>  <p><b>A</b></p>	<b>6283330005</b> 6283331005 6283331805 6273500106 6283330003 6323500306	L=664 T=48	CITARO O 530 - CONECTO O 345
<p><b>0907259</b></p>  <p><b>A</b></p>	<b>0003500506</b> 0003300611	l=130 p=30 D=70 d=19	
<p><b>0807417</b></p> 	<b>3173500706</b> 3593300011 3643307411 6003300111 6643307211 6653307411	L=724 T=56	O 303 - O 340







BARRE DI REAZIONE - TORQUE RODS

RIF. OCAP OCAP REF.	RIF. ORIG O.E. NUMBER	NOTE REMARKS	MODELLO / DESCRIZIONE MODEL / DESCRIPTION
<p><b>0807411</b></p>  <p><b>A</b> <b>A</b></p> <p><b>0907259</b></p>  <p><b>A</b></p>	<p><b>629350006</b> 6293500105 6293501106</p> <p><b>0003500506</b> 0003300611</p>	<p>L=725 T=48</p> <p>I=130 p=30 D=70 d=19</p>	<p>TRAVEGO O 580 - SETRA 400</p>
<p><b>0807542</b></p>  <p><b>A</b> <b>A</b></p> <p><b>0907259</b></p>  <p><b>A</b></p>	<p><b>3573330905</b> 3573330605</p> <p><b>0003500506</b> 0003300611</p>	<p>L=662 T=40</p> <p>d=19</p> <p>I=130 p=30 D=70 d=19</p>	<p>O 405 Citaro N</p>
<p><b>0807822</b></p>  <p><b>A</b> <b>A</b></p> <p><b>0907259</b></p>  <p><b>A</b></p>	<p><b>3573330205</b> 6713330005</p> <p><b>0003500506</b> 0003300611</p>	<p>L=70 T=48 I=130 d=19</p> <p>I=130 p=30 D=70 d=19</p>	<p>O 405 O 405 O G-ST</p>
<p><b>0807414</b></p>  <p><b>A</b> <b>A</b></p> <p><b>0907414</b></p>  <p><b>A</b></p>	<p><b>3563300211</b> 6133300011</p> <p><b>0003501305</b></p>	<p>I=130</p> <p>d=17</p>	<p>O 404</p>
<p><b>0807419</b></p> 	<p><b>3223301011</b> 3573303111</p>	<p>L=775 T=56</p>	<p>O 303 - O 405 - O 407 - O 408</p>

**BARRE DI REAZIONE - TORQUE RODS**

RIF. OCAP OCAP REF.	RIF. ORIG O.E. NUMBER	NOTE REMARKS	MODELLO / DESCRIZIONE MODEL / DESCRIPTION
<p><b>0807531</b></p> 	<p><b>3573330101</b></p>	<p>L=806  d=17</p>	<p>O 405 O</p>
<p><b>0907531</b></p> 	<p><b>0003300107</b></p>	<p>L=245  K=48,6 D=70</p>	
<p><b>0907528</b></p> 	<p><b>0003300707</b></p>	<p>l=115 p=24 D=70 d=17</p>	

**KIT DI SOSPENSIONE - SUSPENSION KITS**

RIF. OCAP OCAP REF.	RIF. ORIG O.E. NUMBER	NOTE REMARKS	MODELLO / DESCRIZIONE MODEL / DESCRIPTION
<b>0907672</b> 	<b>0003501005</b>	l=115 p=24 D=55 d=21	O 404 O O 405 O O 305 Turismo
<b>0907362</b> 	<b>0003500906</b>	l=130  D=85 d=19	O 405 - TOURISMO O 350
<b>0907591</b> 	<b>0003302111</b>	l=115 p=24 D=67 d=17	CITARO O 530 - CONECTO O 345
<b>0907882</b> 	<b>0003300080</b>	l=130 p=30 D=87 d=19	O 405 O - O 407 O - O 408 O
<b>0907883</b> 	<b>0003301611</b>	L=70  D=87	O 405 O - O 407 O - O 408 O
<b>0907407</b> 	<b>0003302011</b>	l=130  D=74,9 d=19	CITARO O 530 - CONECTO O 345
<b>0907531</b> 	<b>0003300107</b>	L=245  K=48,6 D=70	O 405 O
<b>0907259</b> 	<b>0003500506</b> 0003300611	l=130 p=30 D=70 d=19	INTEGRO - TOURISMO - TRAVEGO - O 405
<b>0907528</b> 	<b>0003300707</b>	l=115 p=24 D=70 d=17	CITARO - O 405 - O 407 - O 408

**KIT DI SOSPENSIONE - SUSPENSION KITS**

RIF. OCAP OCAP REF.	RIF. ORIG O.E. NUMBER	NOTE REMARKS	MODELLO / DESCRIZIONE MODEL / DESCRIPTION
<p><b>0907414</b></p> 	<p><b>0003501305</b></p>	<p>l=130  d=17</p>	<p>O 404</p>

**SNODI SOSPENSIONI - SUSPENSION JOINTS**



RIF. OCAP OCAP REF.	RIF. ORIG O.E. NUMBER	NOTE REMARKS	MODELLO / DESCRIZIONE MODEL / DESCRIPTION
<p><b>0402159</b></p> 	<p><b>6313200228</b> 0003200028 0003200128 6083200028 6083200128 6313200028 6313200128</p>		<p>100 - O 100 CITY T1 - HENSCHEL 2t</p>

**STABILIZZATORI - STABILIZERS**





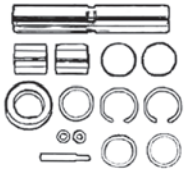











RIF. OCAP OCAP REF.	RIF. ORIG O.E. NUMBER	NOTE REMARKS	MODELLO / DESCRIZIONE MODEL / DESCRIPTION
0587980 	6283201189	L=260 M=20x1,5 RHT	CITARO O 530
0597980 	6283201089	L=260 M=20x1,5 RHT	CITARO O 530
0587981 	6283201389	L=260 M=20x1,5 RHT	CITARO O 530 - CONECTO O 345
0597981 	6283201389	L=260 M=20x1,5 RHT	CITARO O 530 - CONECTO O 345
0587982 	6283200289	L=260 T=36	CITARO O 530
0597982 	6283200089	L=260 T=36	CITARO O 530
0587983 	6283200389	L=260 T=36	CITARO O 530 - CONECTO O 345
0597983 	6283200189	L=260 T=36	CITARO O 530 - CONECTO O 345



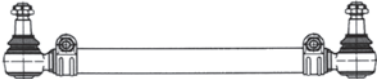

**KIT PERNO FUSO - KING PIN SET**

RIF. OCAP OCAP REF.	RIF. ORIG O.E. NUMBER	NOTE REMARKS	MODELLO / DESCRIZIONE MODEL / DESCRIPTION
<p><b>0927432</b></p> 	<p><b>3553300319</b> 3555860033</p>	<p>L=219</p> <p>D=45</p>	<p>303 O</p>
<p><b>0927436</b></p> 	<p><b>3913300019</b> 3915860033 3895860033</p>	<p>L=222,5</p> <p>D=50/51</p>	<p>ASSE ANTERIORE/FRONT AXLE: 303 O-305 O /G-307 O</p>





## BARRE ACCOPPIAMENTO - TIE RODS

RIF. OCAP OCAP REF.	RIF. ORIG O.E. NUMBER	NOTE REMARKS	MODELLO / DESCRIZIONE MODEL / DESCRIPTION
<b>0507481</b>     <b>0187460</b> M=30x1,5 RHT <b>0196598</b> M=30x1,5 LHT 	<b>122352700</b> 11020291	L=261	
<b>0507954</b>  	<b>81467116886</b> 81467116897 81467116898 81467116899	L=429 T=36	STARLINER N 5218 - TRENDLINER N 3516
<b>0507482</b>  	<b>122352720</b> 11020292	L=500	
<b>0507483</b>     <b>0186598</b> M=30x1,5 RHT <b>0196598</b> M=30x1,5 LHT 	<b>122352740</b>	L=627	
<b>0507474</b>     <b>0186598</b> M=30x1,5 RHT <b>0196598</b> M=30x1,5 LHT 	<b>120328300</b> 11019692	L=660	
<b>0507743</b>     <b>0186598</b> M=30x1,5 RHT <b>0196598</b> M=30x1,5 LHT 	<b>81467116770</b> 81467116772 81467116874 81467116875 81467116876	L=660 T=36	CENTROLINER - CITYLINER - STARLINER - TOURLINER - TRENDLINER
<b>0507468</b>     <b>0186598</b> M=30x1,5 RHT <b>0196598</b> M=30x1,5 LHT 	<b>120322809</b> 11019632	L=940	



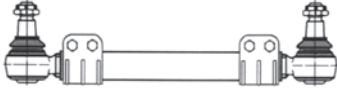

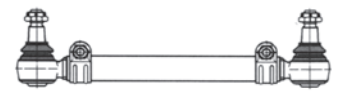
**BARRE ACCOPPIAMENTO - TIE RODS**

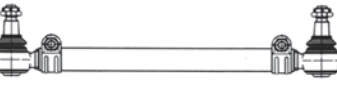
RIF. OCAP OCAP REF.	RIF. ORIG O.E. NUMBER	NOTE REMARKS	MODELLO / DESCRIZIONE MODEL / DESCRIPTION
<p><b>0507471</b></p>  <p><b>0186598</b>      <b>0196598</b> M=30X1,5 RHT    M=30x1,5 LHT</p>	<p><b>120324500</b></p>	<p>L=1045</p>	
<p><b>0507469</b></p>  <p><b>0186598</b>      <b>0196598</b> M=30x1,5 RHT    M=30x1,5 LHT</p>	<p><b>120322812</b> 11019635</p>	<p>L=1762</p>	

TIRANTI LONGITUDINALI - DRAG LINKS

RIF. OCAP OCAP REF.	RIF. ORIG O.E. NUMBER	NOTE REMARKS	MODELLO / DESCRIZIONE MODEL / DESCRIPTION
<p><b>0507477</b></p>  <p><b>0186598</b> M=30x1,5 RHT    <b>0196598</b> M=30x1,5 LHT</p>	<p><b>122350000</b> 11020274</p>	<p>L=300</p>	
<p><b>0507472</b></p>  <p><b>0186598</b> M=30x1,5 RHT    <b>0196598</b> M=30x1,5 LHT</p>	<p><b>120325500</b> 11019664</p>	<p>L=610</p>	
<p><b>0507791</b></p> 	<p><b>81466116045</b></p>	<p>L=628 T=40</p>	<p>CENTROLINER</p>
<p><b>0507480</b></p>  <p><b>0186598</b> M=30x1,5 RHT    <b>0196598</b> M=30x1,5 LHT</p>	<p><b>122351600</b> 11020285</p>	<p>L=753</p>	
<p><b>0507470</b></p>  <p><b>0186598</b> M=30x1,5 RHT    <b>0196598</b> M=30x1,5 LHT</p>	<p><b>120323000</b> 11019641 21041</p>	<p>L=840</p>	<p>316 Transliner</p>
<p><b>0507473</b></p>  <p><b>0186598</b> M=30x1,5 RHT    <b>0196598</b> M=30x1,5 LHT</p>	<p><b>120325800</b></p>	<p>L=900</p>	

**TIRANTI LONGITUDINALI - DRAG LINKS**

RIF. OCAP OCAP REF.	RIF. ORIG O.E. NUMBER	NOTE REMARKS	MODELLO / DESCRIZIONE MODEL / DESCRIPTION
<p><b>0507479</b></p>  <p><b>0186598</b> M=30x1,5 RHT    <b>0196598</b> M=30x1,5 LHT</p>	<p><b>122351500</b></p>	<p>L=900</p>	
<p><b>0507139</b></p>  <p><b>0186424</b> M=30x1,5 RHT</p>	<p><b>3004600605</b> 3004600705 3004600305 3054600305</p>	<p>L=975</p>	<p>O 303 - O 305 - O 307</p>
<p><b>0507138</b></p>  <p><b>0186424</b> M=30x1,5 RHT</p>	<p><b>3004600405</b> 3004600505 3014600505</p>	<p>L=1146</p>	<p>O 303 - O 340 O 340 TOURISMO</p>
<p><b>0507952</b></p>  <p><b>0186758</b> M=30x1,5 RHT</p>	<p><b>36466106007</b> 36466106033 81466106794 81466116044 81466116085 81466116108 81466116114 81466116120</p>	<p>L=1358 T=52</p>	<p>CENTROLINER N 4516-4522</p>



## TESTE STERZO - TIE RODS END

RIF. OCAP OCAP REF.	RIF. ORIG O.E. NUMBER	NOTE REMARKS	MODELLO / DESCRIZIONE MODEL / DESCRIPTION
0187465  	120110403	L=75  M=22x1,5 RHT	
0287361  	122162800 11019859	L=75  M=26x1,5 RHT	
0287466  	120110404 0004632329 0004632629	L=90  M=22x1,5 RHT	
0287291  	120164610	L=95  M=24x1,5 RHT	
0186613  	120325701	L=105  M=28x1,5 RHT	
0196613  	120325702	L=105  M=28x1,5 LHT	
0186612  	120324001	L=105  M=24X1,5 RHT	
0196612  	120324002	L=105  M=24x1,5 LHT	
0187342  	120326100	L=105  M=24x1,5 RHT	O 309 D

**TESTE STERZO - TIE RODS END**

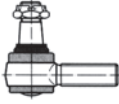
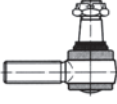
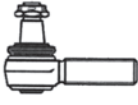
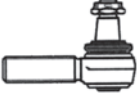

RIF. OCAP OCAP REF.	RIF. ORIG O.E. NUMBER	NOTE REMARKS	MODELLO / DESCRIZIONE MODEL / DESCRIPTION
<b>0197342</b>  	<b>120326200</b>	L=105  M=24x1,5 LHT	O 309 D
<b>0187460</b>  	-	L=105  M=30x1,5 RHT	
<b>0186424</b>  	<b>082192300</b> 0013300135 120325101 11015686	L=115  M=30x1,5 RHT	O 301-O 303-O 340-O 340 TOURISMO O 402-O 405 G/GN/GTD O 405 N/ST O 407- O 408
<b>0196424</b>  	<b>082192200</b> 3023300235 120325100 0003300148 11015685 3023300035 3023300135 3023300335	L=115  M=30x1,5 LHT	O 301-O 303-O 340-O 340 TOURISMO O 402-O 405 G/GN/GTD O 405 N/ST O 407- O 408
<b>0187571</b>  	<b>120326400</b>	L=115  M=30x1,5 RHT	608-709-808 814-814 L 817 LO-817 O
<b>0186598</b>  	<b>120325000</b> 11926 11019659	L=120  M=30x1,5 RHT	N 122/3 Skyliner N 116-N 316 Transliner N 516 SHD Starliner N 4021 Standard
<b>0196598</b>  	<b>120325200</b> 11927 11019661	L=120  M=30x1,5 LHT	N 122/3 Skyliner N 116-N 316 Transliner N 516 SHD Starliner N 4021 Standard
<b>0187146</b>  	<b>120326000</b>	L=120  M=30x1,5 RHT	

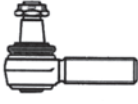
## TESTE STERZO - TIE RODS END





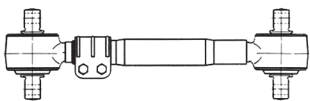
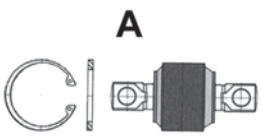
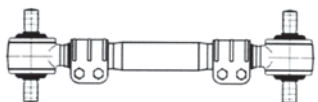
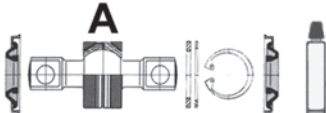

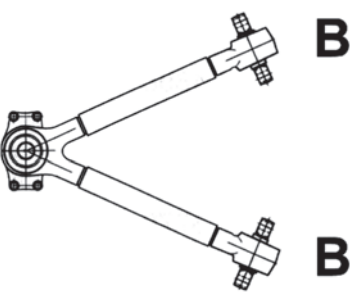

RIF. OCAP OCAP REF.	RIF. ORIG O.E. NUMBER	NOTE REMARKS	MODELLO / DESCRIZIONE MODEL / DESCRIPTION
<b>0186758</b>  	<b>81953010022</b> 0696226 0609643 0586714 0609634 0607073 1337367	L=135  M=30x1,5 RHT	CENTROLINER N 4516-4522
<b>0187463</b>  	<b>122169000</b> 11019933	L=135  M=38x1,5 RHT	
<b>0197463</b>  	<b>122169100</b>	L=135  M=38x1,5 LHT	
<b>0187467</b>  	<b>120322305</b>	L=135  M=38x1,5 RHT	
<b>0197467</b>  	<b>120322300</b>	L=135  M=38x1,5 LHT	
<b>0287136</b>  	<b>0013302135</b> 0003304035 0003307735 0003384929 0013302635	L=140  M=35x1,5 RHT	O 303-O 307 O 340-O 340 TOURISMO O 405-O 407-O 408
<b>0297136</b>  	<b>0013302235</b> 0003301935 0003302935 0003304135 0003307835 0003385029 0013302735	L=140  M=35x1,5 LHT	O 303-O 307 O 340-O 340 TOURISMO O 405-O 407-O 408
<b>0187476</b>  	<b>122169500</b> 11019966	L=150  M=38x1,5 RHT	

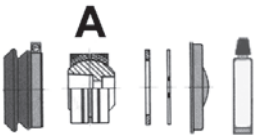

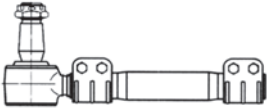
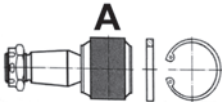







**BARRE DI REAZIONE - TORQUE RODS**

RIF. OCAP OCAP REF.	RIF. ORIG O.E. NUMBER	NOTE REMARKS	MODELLO / DESCRIZIONE MODEL / DESCRIPTION
<p><b>0807816</b></p> 	<b>81432206177</b>	L=330 T=36	CENTROLINER N 4420 - 4421
<p><b>0807357</b></p> <p><b>A</b>  <b>A</b></p> <p><b>0907484</b></p> <p><b>A</b> </p>	<b>082751110</b>  -	L=540  d=17  l=115 p=24 D=62 d=17	
<p><b>0807478</b></p> <p><b>A</b>  <b>A</b></p> <p><b>0907556</b></p> <p><b>A</b> </p> <p><b>0907586</b></p> <p><b>A</b> </p>	<b>122351400</b>  -	L=700  d=21  l=152 p=24 D=65 d=21	
	<b>0005861533</b>	D=65	senza perno (without pin)
<p><b>0807354</b></p> <p><b>A</b>  <b>B</b> <b>B</b></p>	<b>082750900</b> 11015863	L=750  d=19	

BARRE DI REAZIONE - TORQUE RODS

RIF. OCAP OCAP REF.	RIF. ORIG O.E. NUMBER	NOTE REMARKS	MODELLO / DESCRIZIONE MODEL / DESCRIPTION
<p><b>0907257</b></p>  <p><b>0907259</b></p> 	<p><b>082750905</b></p> <p><b>070550504</b> 11013547 81432206396 81432206409 81432206189</p>	<p>D=65</p> <p>IK=38</p> <p>l=130 p=30 D=70 d=19</p>	
<p><b>0807464</b></p>  <p><b>0907485</b></p> 	<p><b>082756320</b></p> <p>-</p>	<p>L=790</p> <p>D=70</p> <p>K=45</p>	
<p><b>0807408</b></p>  <p><b>0907259</b></p> 	<p><b>81432206396</b> 81432206409 81432206189</p> <p><b>070550504</b> 11013547 81432206396 81432206409 81432206189</p>	<p>L=614 T=48 l=130 d=19</p> <p>l=130 p=30 D=70 d=19</p>	CENTROLINER
<p><b>0807806</b></p> 	<p><b>81432206215</b></p>	<p>L=413</p> <p>d=15 l=80</p>	CENTROLINER
<p><b>0807808</b></p> 	<p><b>81432206145</b></p>	<p>L=531 T=48</p>	CENTROLINER N 4516
<p><b>0907259</b></p> 	<p><b>070550504</b> 11013547 81432206396 81432206409 81432206189</p>	<p>l=130 p=30 D=70 d=19</p>	

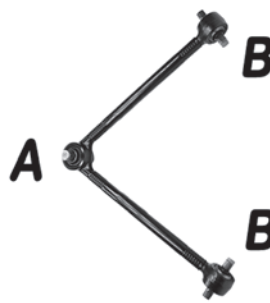





BARRE DI REAZIONE - TORQUE RODS

RIF. OCAP OCAP REF.	RIF. ORIG O.E. NUMBER	NOTE REMARKS	MODELLO / DESCRIZIONE MODEL / DESCRIPTION
<p><b>0807821</b></p>  <p><b>A</b> <b>A</b></p> <p><b>0907259</b></p>  <p><b>A</b></p>	<p><b>81432206161</b> 81432206190</p> <p><b>070550504</b> 11013547 81432206396 81432206409 81432206189</p>	<p>L=531 T=50 l=130 d=19</p> <p>l=130 p=30 D=70 d=19</p>	CENTROLINER
<p><b>0807823</b></p>  <p><b>A</b></p> <p><b>0907259</b></p>  <p><b>A</b></p>	<p><b>81432206151</b> 81432206183 81432206276</p> <p><b>070550504</b> 11013547 81432206396 81432206409 81432206189</p>	<p>L=570 T=48 l=130 d=19</p> <p>l=130 p=30 D=70 d=19</p>	STARLINER - CENTROLINER - CITYLINER TOURLINER - TRENDLINER
<p><b>0807832</b></p>  <p><b>A</b> <b>A</b></p> <p><b>0907362</b></p>  <p><b>A</b></p>	<p><b>81432206258</b> 81432206264 81432206275 81432206278 81432206279</p> <p><b>5001850588</b> 5000333285 5001860300 5010393047 42536819 81432206369 81432206250</p>	<p>L=622 T=48 l=130 d=19</p>	CENTROLINER - CITYLINER - STARLINER - TOURLINER
<p><b>0807844</b></p>  <p><b>A</b> <b>B</b> <b>B</b></p> <p><b>0907844</b></p>  <p><b>A</b></p>	<p><b>81433156037</b> 81433156036</p> <p><b>81433150009</b></p>	<p>L=782 T=48</p> <p>l=145 p=35 D=95 d=19</p>	CENTROLINER

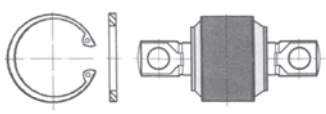
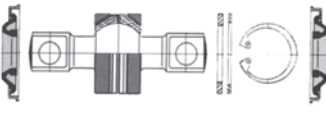

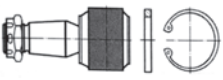
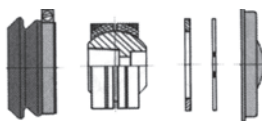
## BARRE DI REAZIONE - TORQUE RODS

RIF. OCAP OCAP REF.	RIF. ORIG O.E. NUMBER	NOTE REMARKS	MODELLO / DESCRIZIONE MODEL / DESCRIPTION
<b>0907845</b>  <b>B</b> 	<b>81432706133</b> 5001847026	l=130 p=30 D=85 d=21	



**KIT DI SOSPENSIONE - SUSPENSION KITS**

RIF. OCAP OCAP REF.	RIF. ORIG O.E. NUMBER	NOTE REMARKS	MODELLO / DESCRIZIONE MODEL / DESCRIPTION
<b>0907484</b> 	-	l=115 p=24 D=62 d=17	
<b>0907556</b> 	-	l=152 p=24 D=65 d=21	
<b>0907586</b> 	<b>0005861533</b>	D=65	senza perno (without pin)
<b>0907485</b> 	-	D=70  K=45	
<b>0907257</b> 	<b>082750905</b>	D=65  IK=38	-
<b>0907845</b> 	<b>81432706133</b> 5001847026	l=130 p=30 D=85 d=21	CENTROLINER
<b>0907259</b> 	<b>070550504</b> 11013547 81432206396 81432206409 81432206189	l=130 p=30 D=70 d=19	TRANSLINER - CENTROLINER - STARLINER CITYLINER - TOURLINER - TRENDLINER
<b>0907407</b> 	<b>85432206002</b> 500333284 0003302011	l=130  d=19	CENTROLINER - STARLINER - TRENDLINER





## KIT DI SOSPENSIONE - SUSPENSION KITS

RIF. OCAP OCAP REF.	RIF. ORIG O.E. NUMBER	NOTE REMARKS	MODELLO / DESCRIZIONE MODEL / DESCRIPTION
<b>0907362</b> 	<b>5001850588</b> 5000333285 5001860300 5010393047 42536819 81432206369 81432206250		CENTROLINER - CITYLINER - TOURLINER - TRENDLINER
<b>0907623</b> 	<b>082751027</b>		
<b>0907844</b> 	<b>81433150009</b>	l=145 p=35 D=95 d=19	CENTROLINER

## BARRE ACCOPPIAMENTO - TIE RODS

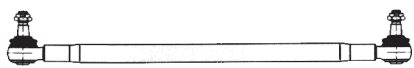

RIF. OCAP OCAP REF.	RIF. ORIG O.E. NUMBER	NOTE REMARKS	MODELLO / DESCRIZIONE MODEL / DESCRIPTION
<b>0507989</b> 	<b>5000761673</b> 5010104286 5010207728	L=555 T=36	FR1 - ILIADE
<b>0507986</b>   <b>0186598</b> M=30x1,5 RHT	<b>5010190148</b> 0000755676	L=1855 T=40	PR 100-110-180 - GX 107

**TIRANTI LONGITUDINALI - DRAG LINKS**



RIF. OCAP OCAP REF.	RIF. ORIG O.E. NUMBER	NOTE REMARKS	MODELLO / DESCRIZIONE MODEL / DESCRIPTION
<p><b>0507744</b></p>  <p><b>0186598</b> M=30x1,5 RH</p>	<p><b>5001829030</b> 5000786768</p>	<p>L=642</p>	<p>PR14</p>
<p><b>0506693</b></p>  <p><b>0186424</b> M=30x1,5 RHT</p>	<p><b>5000932435</b> 5010174787</p>	<p>L=940</p>	<p>Gamma S45/S53 A.R. Gamma S45/S53 A.V.</p>
<p><b>0506694</b></p>  <p><b>0186598</b> M=30x1,5 RHT</p>	<p><b>5000998430</b> 5010174785</p>	<p>L=1200</p>	<p>Gamma S45/S53 A.R. Gamma S45/S53 A.V.</p>
<p><b>0507678</b></p> 	<p><b>5010207724</b> 5010151528 5000761671</p>	<p>L=1475</p>	<p>Gamma FR1</p>
<p><b>0506692</b></p>  <p><b>0186598</b> M=30x1,5 RHT</p>	<p><b>5010207725</b> 5000761670 5010151529 5000786527 5010104289</p>	<p>L=2085</p>	<p>Gamma FR1- FRH</p>



## TESTE STERZO - TIE RODS END

RIF. OCAP OCAP REF.	RIF. ORIG O.E. NUMBER	NOTE REMARKS	MODELLO / DESCRIZIONE MODEL / DESCRIPTION
<b>0186424</b>  	<b>5000295214</b> 0003406212 0003406242 0003406253 5000242159 5000559335 5000812483 5001831473 7701016946 5001832582	L=115  M=30x1,5 RHT	Gamma: M-S-J
<b>0186598</b>  	<b>5000288360</b> 0003401169 0003406236 0003406251 0003406254 0003406260 0003406261 5000590236 5000804824 5001836298 7701011412 5010832582 5001858773	L=120  M=30x1,5 RHT	AE-C-G-R MAGNUM-PREMIUM

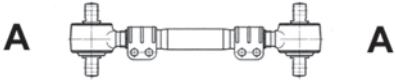
**BARRE DI REAZIONE - TORQUE RODS**

RIF. OCAP OCAP REF.	RIF. ORIG O.E. NUMBER	NOTE REMARKS	MODELLO / DESCRIZIONE MODEL / DESCRIPTION
<b>0807673</b> 	<b>5000640089</b> 5000869619	L=500 T=40	TRACER
<b>0807750</b> 	<b>5010347099</b>	L=575  d=19	ILIADE-ARES
<b>0907259</b> 	<b>5001842823</b>	l=130 p=30 D=70 d=19	-





## KIT DI SOSPENSIONE - SUSPENSION KITS

RIF. OCAP OCAP REF.	RIF. ORIG O.E. NUMBER	NOTE REMARKS	MODELLO / DESCRIZIONE MODEL / DESCRIPTION
<b>0907259</b>  	<b>5001842823</b>	l=130 p=30 D=70 d=19	IRISBUS: ACCESS - ARWAY CITELIS - CROSSWAY EVADYS ILIADE-ARES

**SNODI SOSPENSIONI - SUSPENSION JOINTS**

RIF. OCAP OCAP REF.	RIF. ORIG O.E. NUMBER	NOTE REMARKS	MODELLO / DESCRIZIONE MODEL / DESCRIPTION
<p><b>0407219</b></p> 	<p><b>5000489779</b> 5010393672</p>	<p>M=30x1,5 RHT</p>	<p>FR1 - ILIADE</p>







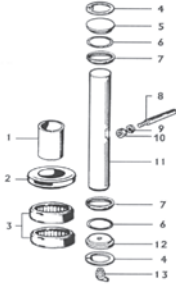





## STABILIZZATORI - STABILIZERS

RIF. OCAP OCAP REF.	RIF. ORIG O.E. NUMBER	NOTE REMARKS	MODELLO / DESCRIZIONE MODEL / DESCRIPTION
<b>0587992</b> 	<b>5010151409</b> 5000869761	L=120 T=31	FR1 - ILIADE (ANTERIORE - FRONT)
<b>0597992</b> 	<b>5010151410</b> 5000786379 5000869762	L=120 T=31	FR1 - ILIADE (ANTERIORE - FRONT)
<b>0507993</b> 	<b>5000869763</b> 5010151411	L=120 T=31	FR1 - ILIADE (POSTERIORE - REAR)
<b>0507888</b> 	<b>5010199642</b>	L=195	





**KIT PERNO FUSO - KING PIN SET**

RIF. OCAP OCAP REF.	RIF. ORIG O.E. NUMBER	NOTE REMARKS	MODELLO / DESCRIZIONE MODEL / DESCRIPTION
<p><b>0927450</b></p> 	<p>-</p> <p>5000792140 (1) 5010358235 (2) 5003090044 (3) 7703066039 (4) 5000737998 (5) 0948381406 (6) 5003087037 (7) 5010056288 (8) 5003055030 (9) 5010056002 (11) 5000737675 (12) 5005097016 (13)</p>	<p>L=277</p> <p>D=50</p>	<p>BUS TRACER</p>

## TIRANTI LONGITUDINALI - DRAG LINKS



RIF. OCAP OCAP REF.	RIF. ORIG O.E. NUMBER	NOTE REMARKS	MODELLO / DESCRIZIONE MODEL / DESCRIPTION
<b>0507996</b>   <b>0186598</b> M=30x1,5 RHT	<b>1450364</b> 1755502 1895860	L=882 T=48	IRIZAR PB
<b>0507758</b>   <b>0186598</b> M=30x1,5 RHT	<b>412406</b>	L=898 T=50	SERIE K 113 - F 113 - L113
<b>0507998</b>   <b>0186598</b> M=30x1,5 RHT	<b>0466336</b> 466336	L=992 T=48	SERIE 3 K 113- F 113 - L113
<b>0507730</b>   <b>0186598</b> M=30x1,5 RHT	<b>415400</b> 0415400	L=1015	Serie 3 K 112
<b>0509882</b>   <b>0186960</b> M=30x1,5 RHT	<b>1197339</b>	L=1028 T=62	SERIE B10 - B12
<b>0506938</b>   <b>0186598</b> M=30x1,5 RHT	<b>466881</b>	L=1045	SERIE 3: K 113 Sosp. pneumatiche (Pneumatic suspension)

**TIRANTI LONGITUDINALI - DRAG LINKS**









RIF. OCAP OCAP REF.	RIF. ORIG O.E. NUMBER	NOTE REMARKS	MODELLO / DESCRIZIONE MODEL / DESCRIPTION
<p><b>0509880</b></p>  <p><b>0186598</b> M=30x1,5 RHT</p>	<p><b>466880</b> 0466880</p>	<p>L=1105 T=52</p>	<p>SERIE 3 K 113- F 113 - L113</p>
<p><b>0507995</b></p>  <p><b>0186598</b> M=30x1,5 RHT</p>	<p><b>1479122</b> 1755498 1895858</p>	<p>L=1272 T=62</p>	<p>SERIE K 250-270-310-360-400-410-440</p>
<p><b>0506933</b></p>  <p><b>0186598</b> M=30x1,5 RHT</p>	<p><b>432698</b></p>	<p>L=1365</p>	<p>K 113</p>
<p><b>0507189</b></p>  <p><b>0186598</b> M=30x1,5 RHT</p>	<p><b>470272</b></p>	<p>Lt=1335</p>	<p>K 113</p>







## TESTE STERZO - TIE RODS END

RIF. OCAP OCAP REF.	RIF. ORIG O.E. NUMBER	NOTE REMARKS	MODELLO / DESCRIZIONE MODEL / DESCRIPTION
<b>0186598</b> 	<b>1358793</b> 283784 468286 395010 1738381 1767328	L=120  M=30x1,5 RHT	SERIE 3: K 93 - K 113 SERIE 4 F 113 - L113 SERIE K 250-270-310-360-400-410-440
<b>0196598</b> 	<b>283783</b> 395009 468285 1358792 1738380	L=120  M=30x1,5 LHT	SERIE 3: K 93 - K 113 SERIE 4
<b>0186960</b> 	<b>1695776</b> 1507826 1695585 1698557	L=120  M=30x1,5 RHT	B 10 - B 12



BARRE DI REAZIONE - TORQUE RODS

RIF. OCAP OCAP REF.	RIF. ORIG O.E. NUMBER	NOTE REMARKS	MODELLO / DESCRIZIONE MODEL / DESCRIPTION
<p><b>0807451</b></p>  <p><b>A</b> <b>A</b></p> <p><b>0907528</b></p>  <p><b>A</b></p>	<p><b>0477889</b> 1431471</p> <p><b>639370</b> 550799 550806 0639370 1104334 112506 1517403</p>	<p>L=532 T=46 l=115</p> <p>l=115 p=24 D=62 d=17</p>	IRIZAR PB
<p><b>0807452</b></p>  <p><b>A</b> <b>A</b></p> <p><b>0907528</b></p>  <p><b>A</b></p>	<p><b>1438475</b> 1863130</p> <p><b>639370</b> 550799 550806 0639370 1104334 112506 1517403</p>	<p>L=539 T=50 l=115</p> <p>l=115 p=24 D=62 d=17</p>	IRIZAR PB
<p><b>0807901</b></p>  <p><b>A</b> <b>A</b></p> <p><b>0907362</b></p>  <p><b>A</b></p>	<p><b>1431710</b> 1514274 489037</p> <p><b>1435944</b></p>	<p>L=640 T=48 l=130</p> <p>l=130 D=85 d=19</p>	IRIZAR PB - 3 SERIE - K-S SERIE
<p><b>0807455</b></p>  <p><b>A</b> <b>A</b></p> <p><b>0907362</b></p>  <p><b>A</b></p>	<p><b>1796671</b> 445599 489989</p> <p><b>1435944</b></p>	<p>L=650 T=48 l=130</p> <p>l=130 D=85 d=19</p>	IRIZAR PB - 3 SERIE - K-S SERIE

## BARRE DI REAZIONE - TORQUE RODS

RIF. OCAP OCAP REF.	RIF. ORIG O.E. NUMBER	NOTE REMARKS	MODELLO / DESCRIZIONE MODEL / DESCRIPTION
<b>0807453</b> 	<b>463435</b>	L=750 T=38 I=100	SERIE 3
<b>0907405</b> 	<b>639319</b> 550812	I=100  D=67 d=17	
<b>0809879</b> 	<b>489986</b>	L=902/703 T=48	SERIE 4: K94 - L 94 - N 94
<b>0907362</b> 	<b>1435944</b>	I=130  D=85 d=19	



**KIT DI SOSPENSIONE - SUSPENSION KITS**

RIF. OCAP OCAP REF.	RIF. ORIG O.E. NUMBER	NOTE REMARKS	MODELLO / DESCRIZIONE MODEL / DESCRIPTION
<b>0907528</b> 	<b>639370</b> 550799 550806 0639370 1104334 112506 1517403	l=115 p=24 D=62 d=17	IRIZAR PB
<b>0907362</b> 	<b>1435944</b>	l=130  D=85 d=19	IRIZAR PB - SERIE 4 K94 - L 94 - N 94
<b>0907405</b> 	<b>639319</b> 550812	l=100  D=67 d=17	SERIE 3





**STABILIZZATORI - STABILIZERS**

RIF. OCAP OCAP REF.	RIF. ORIG O.E. NUMBER	NOTE REMARKS	MODELLO / DESCRIZIONE MODEL / DESCRIPTION
<b>0509886</b> 	<b>1766014</b> 463245	L=100 T=31	SERIE K
<b>0509889</b> 	<b>1766015</b> 445626	L=130 T=31	SERIE K - SERIE 3
<b>0589888</b> 	<b>1506924</b>	L=150 T=30	SERIE K - SERIE IRIZAR PB (DESTRO - RIGHT)
<b>0599888</b> 	<b>1506925</b>	L=150 T=30	SERIE K - SERIE IRIZAR PB (SINISTRO - LEFT)
<b>0509890</b> 	<b>1455327</b> 1751418 1789082 1928859 483527	L=284 T=36	SERIE K - IRIZAR PB
<b>0509913</b> 	<b>488738</b>	L=293 T=36	SERIE F-K-N - IRIZAR PB





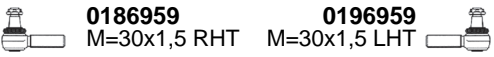

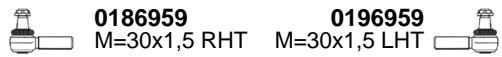





**KIT PERNO FUSO - KING PIN SET**

RIF. OCAP OCAP REF.	RIF. ORIG O.E. NUMBER	NOTE REMARKS	MODELLO / DESCRIZIONE MODEL / DESCRIPTION
<p><b>0927452</b></p> 	<p><b>550732</b> 550713 550714</p>	<p>L=228</p> <p>D=53,5/44,5</p>	<p>K 112 1984 &gt; BR 116 1980 &gt;</p>
<p><b>0927453</b></p> 	<p><b>550730</b> 550729</p>	<p>L=215</p> <p>D=44,5/55</p>	<p>K 113 1986 &gt;</p>

## BARRE ACCOPPIAMENTO - TIE RODS



RIF. OCAP OCAP REF.	RIF. ORIG O.E. NUMBER	NOTE REMARKS	MODELLO / DESCRIZIONE MODEL / DESCRIPTION
<b>0507224</b>  	<b>3112050</b>	L=300	B6 - B7 - B10
<b>0507109</b>    <b>0186959</b> <b>0196959</b> M=30x1,5 RHT    M=30x1,5 LHT	<b>1626494</b>	L=1592	B 56
<b>0509900</b>    <b>0186959</b> <b>0196959</b> M=30x1,5 RHT    M=30x1,5 LHT	<b>8156123</b>	L=1674 T=42	B 10 - B 12

TIRANTI LONGITUDINALI - DRAG LINKS









RIF. OCAP OCAP REF.	RIF. ORIG O.E. NUMBER	NOTE REMARKS	MODELLO / DESCRIZIONE MODEL / DESCRIPTION
<b>0509892</b> 	<b>85104265</b> 85114167 3098294	L=495 T=40	B 12 - IRIZAR PB
<b>0507223</b> 	<b>3112273</b>	L=743	B 6 - B 7 - B 10
<b>0507222</b>   <b>0186946</b> M=30x1,5 RHT	<b>3112122</b>	L=763	B 12
<b>0509882</b>   <b>0186960</b> M=30x1,5 RHT	<b>1197339</b>	L=1028 T=62	SERIE B10 - B12
<b>0507692</b>   <b>0186960</b> M=30x1,5 RHT	<b>1197338</b>	L=1028	B 10 B - B 10 BLE B 10 N - B 12
<b>0507686</b>   <b>0187686</b> M=30x1,5 RHT	<b>20490120</b> 20745924 21308024 9519279	L=1028 T=60	8500-8700-9700-9900-IRIZAR PB-B10-B12
<b>0509899</b>   <b>0186424</b> M=30x1,5 RHT	<b>3039647</b>	L=1041 T=42	B 6 B6R



## TIRANTI LONGITUDINALI - DRAG LINKS

RIF. OCAP OCAP REF.	RIF. ORIG O.E. NUMBER	NOTE REMARKS	MODELLO / DESCRIZIONE MODEL / DESCRIPTION
<b>0509901</b>   <b>0186960</b> M=30x1,5 RHT	<b>3116050</b>	L=1822 T=50	BUS B 10 B10M

**TESTE STERZO - TIE RODS END**

RIF. OCAP OCAP REF.	RIF. ORIG O.E. NUMBER	NOTE REMARKS	MODELLO / DESCRIZIONE MODEL / DESCRIPTION
<b>0186595</b>  	<b>1518142</b>	L=95  M=25x1,5 RHT	B 12
<b>0196595</b>  	<b>1517448</b>	L=95  M=24x1,5 LHT	B 12
<b>0186960</b>  	<b>1695776</b> 1507826 1695585 1698557	L=120  M=30x1,5 RHT	B 9 M- B 10 M- B 12
<b>0196960</b>  	<b>1698840</b> 1131744 1698558 6869744	L=120  M=30x1,5 LHT	B 9 M- B 10 M- B 12
<b>0186959</b>  	<b>1698846</b>	L=120  M=30x1,5 RHT	B 12
<b>0196959</b>  	<b>1698847</b>	L=120  M=30x1,5 LHT	B 12
<b>0187686</b>  	<b>3093647</b> 21263821	L=140 M=30x1,5 RHT	BUS 8500-8700-9700-9900-IRIZAR PB-B10-B12
<b>0286964</b>  	<b>1699401</b> 1131742 1696901	L=168  M=52x1,5 RHT	B 7-B 7 F-B 7 R B 9 M- B 12 B 10 M-B 10 R B 58-310 M



## TESTE STERZO - TIE RODS END

RIF. OCAP OCAP REF.	RIF. ORIG O.E. NUMBER	NOTE REMARKS	MODELLO / DESCRIZIONE MODEL / DESCRIPTION
<b>0296964</b>  	<b>1699400</b> 1131741 1696900	L=168  M=52x1,5 LHT	B 7-B 7 F-B 7 R B 9 M- B 12 B 10 M-B 10 R B 58-310 M

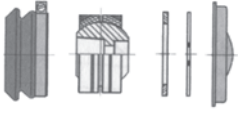

**KIT DI SOSPENSIONE - SUSPENSION KITS**

RIF. OCAP OCAP REF.	RIF. ORIG O.E. NUMBER	NOTE REMARKS	MODELLO / DESCRIZIONE MODEL / DESCRIPTION
<p><b>0907297</b></p> 	<p><b>3093469</b></p>	<p>IK=38  D=65</p>	<p>B12</p>

## STABILIZZATORI - STABILIZERS

RIF. OCAP OCAP REF.	RIF. ORIG O.E. NUMBER	NOTE REMARKS	MODELLO / DESCRIZIONE MODEL / DESCRIPTION
<b>0109903</b>  	<b>948372</b>	L=40  M=8x1 RHT	B 10 B10M
<b>0509906</b>  	<b>3112282</b>	L=220 T=31  M=24x1,5 RHT	B 9
<b>0509904</b>  	<b>1196631</b>	L=354	BUS B10 - B12

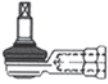
**TESTE COMANDO CAMBIO - GEAR BOX CONTROL BALL JOINTS**

RIF. OCAP OCAP REF.	RIF. ORIG O.E. NUMBER	NOTE REMARKS	MODELLO / DESCRIZIONE MODEL / DESCRIPTION
<p><b>0287229</b></p> 	<p><b>1696685</b></p>	<p>L=55</p> <p>M=12x1,75 RH</p>	<p>B 6 - B 7 - B 10</p>
<p><b>0297229</b></p> 	<p><b>1696684</b></p>	<p>L=55</p> <p>M=12x1,75 RH</p>	<p>B 6 - B 7 - B 10</p>

**KIT PERNO FUSO - KING PIN SET**

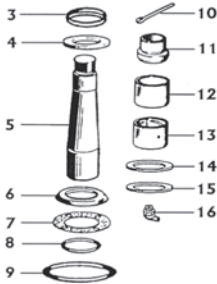
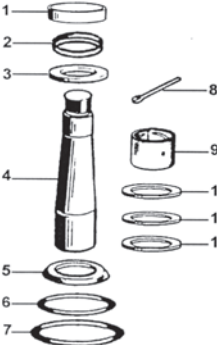
RIF. OCAP OCAP REF.	RIF. ORIG O.E. NUMBER	NOTE REMARKS	MODELLO / DESCRIZIONE MODEL / DESCRIPTION
<p><b>0927456</b></p> 	<p><b>3090267</b> 271141 270911 276015 276024 276030 276032</p>	<p>L=237  D=48</p>	<p>ASSALE/AXLE: 253270-253283-253295  B6 - B7F - B7FA 1983 &gt; B9M - B10M - B10MBR - B10R 1978 &gt; B12 B57 - B58 - B59 1976 &gt;</p>
<p><b>0927458</b></p> 	<p><b>3090266</b> 271142 270912 276023 276031 1585989 (2) 1588011 (3) 1621564 (4) 907888 (8) 1599575 (9)</p>	<p>L=251  D=50/38</p>	<p>ASSALE/AXLE: 253290  BUS: B9M CH.20001 &gt; B10M - B10B - B10BLE - B10L C10M B12 - B12BR</p>

Cross Reference Guide

RIF. ORIG O.E. NUMBER	RIF. OCAP REF. OCAP	MARCA	PAG.	RIF. ORIG O.E. NUMBER	RIF. OCAP REF. OCAP	MARCA	PAG.
0000712758	0506642	RENAULT V.I.	9-9	0003301635	0187560	MERCEDES	7-25
0000721608	0506642	RENAULT V.I.	9-9	0003301635	0187560	VEICOLI COMMERCIALI - LCV VEHICLE	1-45
0000755676	0507986	RENAULT V.I. BUS	18-1	0003301935	0297136	NEOPLAN BUS	17-7
0002680189	0187228	MERCEDES	7-51	0003302011	0907407	MAN BUS	15-8
0002684689	0287229	MERCEDES	7-51	0003302011	0907407	MERCEDES BUS	16-17
0002684789	0297229	MERCEDES	7-51	0003302011	0907407	NEOPLAN BUS	17-12
0002684889	0187228	MERCEDES	7-51	0003302111	0907591	MERCEDES BUS	16-13
0002685589	0287646	MERCEDES	7-51	0003302410	0186595	MERCEDES	7-25
0002686189	0297229	MERCEDES	7-51	0003302635	0180729	MERCEDES	7-29
0002686289	0287229	MERCEDES	7-51	0003302735	0180729	MERCEDES	7-29
0002686389	0287646	MERCEDES	7-51	0003302835	0287136	MERCEDES	7-28
0003200028	0402159	MERCEDES	7-50	0003302835	0287136	MERCEDES BUS	16-11
0003200028	0402159	MERCEDES BUS	16-19	0003302935	0297136	MERCEDES	7-28
0003200028	0402159	VEICOLI COMMERCIALI - LCV VEHICLE	1-37	0003302935	0297136	MERCEDES BUS	16-11
0003200128	0402159	MERCEDES	7-50	0003302935	0297136	NEOPLAN BUS	17-7
0003200128	0402159	MERCEDES BUS	16-19	0003303135	0186547	MERCEDES	7-27
0003200128	0402159	VEICOLI COMMERCIALI - LCV VEHICLE	1-37	0003303135	0186547	MERCEDES BUS	16-9
0003201232	0507433	MERCEDES BUS	16-1	0003303235	0186424	MERCEDES	7-26
0003300035	0196424	MERCEDES	7-27	0003303235	0186424	MERCEDES BUS	16-9
0003300080	0907882	MERCEDES BUS	16-12	0003303335	0196613	MERCEDES	7-26
0003300107	0907531	MERCEDES BUS	16-16	0003303335	0196613	MERCEDES BUS	16-9
0003300148	0196424	MERCEDES	7-27	0003304035	0287136	MERCEDES	7-28
0003300148	0196424	MERCEDES BUS	16-9	0003304035	0287136	MERCEDES BUS	16-11
0003300148	0196424	NEOPLAN BUS	17-6	0003304035	0287136	NEOPLAN BUS	17-7
0003300235	0196595	MERCEDES	7-25	0003304135	0297136	MERCEDES	7-28
0003300248	0186424	MERCEDES	7-26	0003304135	0297136	MERCEDES BUS	16-11
0003300248	0186424	MERCEDES BUS	16-9	0003304135	0297136	NEOPLAN BUS	17-7
0003300335	0186595	MERCEDES	7-25	0003305035	0180730	MERCEDES	7-25
0003300511	0907927	MERCEDES	7-47	0003305035	0180730	MERCEDES BUS	16-8
0003300611	0907259	MERCEDES BUS	16-12	0003305635	0187342	MERCEDES	7-26
0003300635	0186595	MERCEDES	7-25	0003305635	0187342	MERCEDES BUS	16-9
0003300707	0907528	MERCEDES BUS	16-16	0003305835	0186424	MERCEDES	7-26
0003300735	0196595	MERCEDES	7-25	0003305835	0186424	MERCEDES BUS	16-9
0003300835	0180729	MERCEDES	7-29	0003306735	0186595	MERCEDES	7-25
0003301035	0187560	MERCEDES	7-25	0003306835	0196595	MERCEDES	7-25
0003301035	0187560	VEICOLI COMMERCIALI - LCV VEHICLE	1-45	0003306935	0190729	MERCEDES	7-29
0003301135	0187560	MERCEDES	7-25	0003307035	0180729	MERCEDES	7-29
0003301135	0187560	VEICOLI COMMERCIALI - LCV VEHICLE	1-45	0003307135	0186613	MERCEDES	7-26
0003301235	0186612	MERCEDES	7-26	0003307135	0186613	MERCEDES BUS	16-9
0003301235	0186612	MERCEDES BUS	16-8	0003307135	0186613	VEICOLI COMMERCIALI - LCV VEHICLE	1-45
0003301235	0186612	VEICOLI COMMERCIALI - LCV VEHICLE	1-48	0003307235	0196613	MERCEDES	7-26
0003301335	0196612	MERCEDES	7-26	0003307235	0196613	MERCEDES BUS	16-9
0003301335	0196612	MERCEDES BUS	16-8	0003307335	0186424	MERCEDES	7-26
0003301335	0196612	VEICOLI COMMERCIALI - LCV VEHICLE	1-48	0003307335	0186424	MERCEDES BUS	16-9
0003301411	0907635	MERCEDES	7-45	0003307335	0186424	MERCEDES	7-26
0003301435	0186613	MERCEDES	7-26	0003307535	0186612	MERCEDES	7-26
0003301435	0186613	MERCEDES BUS	16-9	0003307535	0186612	MERCEDES BUS	16-8
0003301435	0186613	VEICOLI COMMERCIALI - LCV VEHICLE	1-45	0003307535	0186612	VEICOLI COMMERCIALI - LCV VEHICLE	1-48
0003301535	0186613	MERCEDES	7-26	0003307535	0186612	MERCEDES	7-26
0003301535	0186613	MERCEDES BUS	16-9	0003307635	0196612	MERCEDES	7-26
0003301535	0186613	VEICOLI COMMERCIALI - LCV VEHICLE	1-45	0003307735	0287136	MERCEDES	7-28
0003301611	0907883	MERCEDES BUS	16-12	0003307735	0287136	MERCEDES BUS	16-11
				0003307735	0287136	NEOPLAN BUS	17-7
				0003307835	0297136	MERCEDES	7-28
				0003307835	0297136	MERCEDES BUS	16-11
				0003307835	0297136	NEOPLAN BUS	17-7
				0003308135	0186547	MERCEDES	7-27
				0003308135	0186547	MERCEDES BUS	16-9



Cross Reference Guide

RIF. ORIG O.E. NUMBER	RIF. OCAP REF. OCAP	MARCA	PAG.	RIF. ORIG O.E. NUMBER	RIF. OCAP REF. OCAP	MARCA	PAG.
0003308535	0186595	MERCEDES	7-25	0003401206	0196599	RENAULT V.I.	9-13
0003308635	0196595	MERCEDES	7-25	0003401207	0186599	RENAULT V.I.	9-13
0003308735	0186595	MERCEDES	7-25	0003406212	0186424	RENAULT V.I.	9-12
0003308835	0196595	MERCEDES	7-25	0003406212	0186424	RENAULT V.I. BUS	18-3
0003309335	0186613	MERCEDES	7-26	0003406213	0196424	RENAULT V.I.	9-12
0003309335	0186613	MERCEDES BUS	16-9	0003406218	0196424	RENAULT V.I.	9-12
0003309335	0186613	VEICOLI COMMERCIALI - LCV VEHICLE	1-45	0003406236	0186598	RENAULT V.I.	9-13
0003309435	0196613	MERCEDES	7-26	0003406236	0186598	RENAULT V.I. BUS	18-3
0003309435	0196613	MERCEDES BUS	16-9	0003406242	0186424	RENAULT V.I.	9-12
0003309535	0186613	MERCEDES	7-26	0003406242	0186424	RENAULT V.I. BUS	18-3
0003309535	0186613	MERCEDES BUS	16-9	0003406242	0186613	RENAULT V.I.	9-11
0003309535	0186613	VEICOLI COMMERCIALI - LCV VEHICLE	1-45	0003406251	0186598	RENAULT V.I.	9-13
0003309635	0196613	MERCEDES	7-26	0003406251	0186598	RENAULT V.I. BUS	18-3
0003309635	0196613	MERCEDES BUS	16-9	0003406252	0186595	RENAULT V.I.	9-11
0003309735	0186612	MERCEDES	7-26	0003406253	0186424	RENAULT V.I.	9-12
0003309735	0186612	MERCEDES BUS	16-8	0003406253	0186424	RENAULT V.I. BUS	18-3
0003309735	0186612	VEICOLI COMMERCIALI - LCV VEHICLE	1-48	0003406254	0186598	RENAULT V.I.	9-13
0003309835	0196612	MERCEDES	7-26	0003406254	0186598	RENAULT V.I. BUS	18-3
0003309835	0196612	MERCEDES BUS	16-8	0003406260	0186598	RENAULT V.I.	9-13
0003309835	0196612	VEICOLI COMMERCIALI - LCV VEHICLE	1-48	0003406260	0186598	RENAULT V.I. BUS	18-3
0003309935	0186612	MERCEDES	7-26	0003406261	0186598	RENAULT V.I.	9-13
0003309935	0186612	MERCEDES BUS	16-8	0003406261	0186598	RENAULT V.I. BUS	18-3
0003309935	0186612	VEICOLI COMMERCIALI - LCV VEHICLE	1-48	0003500105	0907584	MERCEDES	7-41
0003381610	0187560	MERCEDES	7-25	0003500113	0907541	MERCEDES	7-43
0003381610	0187560	VEICOLI COMMERCIALI - LCV VEHICLE	1-45	0003500205	0907620	MERCEDES	7-46
0003381810	0187342	MERCEDES	7-26	0003500213	0907556	MERCEDES	7-30
0003381810	0187342	MERCEDES BUS	16-9	0003500305	0907556	MERCEDES	7-30
0003382129	0186613	MERCEDES	7-26	0003500405	0907584	MERCEDES	7-41
0003382129	0186613	MERCEDES BUS	16-9	0003500413	0907330	MERCEDES	7-31
0003382129	0186613	VEICOLI COMMERCIALI - LCV VEHICLE	1-45	0003500505	0907556	MERCEDES	7-30
0003383410	0186424	MERCEDES	7-26	0003500506	0907259	MERCEDES BUS	16-12
0003383410	0186424	MERCEDES BUS	16-9	0003500613	0907304	MERCEDES	7-30
0003383429	0186612	MERCEDES	7-26	0003500906	0907362	MERCEDES BUS	16-17
0003383429	0186612	MERCEDES BUS	16-8	0003501005	0907672	MERCEDES BUS	16-13
0003383429	0186612	VEICOLI COMMERCIALI - LCV VEHICLE	1-48	0003501013	0907531	MERCEDES	7-37
0003383529	0186612	MERCEDES	7-26	0003501305	0907414	MERCEDES BUS	16-15
0003383529	0186612	MERCEDES BUS	16-8	0003501505	0907201	MERCEDES	7-46
0003383529	0186612	VEICOLI COMMERCIALI - LCV VEHICLE	1-48	0003501805	0907304	MERCEDES	7-30
0003383629	0186613	MERCEDES BUS	16-9	0003501905	0907623	MERCEDES	7-49
0003384929	0287136	MERCEDES	7-28	0003502005	0907984	MERCEDES	7-39
0003384929	0287136	MERCEDES BUS	16-11	0003502105	0907622	MERCEDES	7-39
0003384929	0287136	NEOPLAN BUS	17-7	0003502205	0907609	MERCEDES	7-39
0003385029	0297136	MERCEDES	7-28	0003502305	0907634	MERCEDES	7-39
0003385029	0297136	MERCEDES BUS	16-11	0003502405	0907774	IVECO TRUCK	5-25
0003385029	0297136	NEOPLAN BUS	17-7	0003502405	0907774	MAN	6-19
0003401151	0287753	RENAULT V.I.	9-15	0003502405	0907774	MERCEDES	7-40
0003401152	0297753	RENAULT V.I.	9-15	0003502505	0907599	MERCEDES	7-39
0003401169	0186598	RENAULT V.I.	9-13	0003502705	0907547	MERCEDES	7-31
0003401169	0186598	RENAULT V.I. BUS	18-3	0003503305	0907840	MERCEDES	7-47
0003401170	0196598	RENAULT V.I.	9-13	0003503605	0907908	MERCEDES	7-38
0003401202	0297753	RENAULT V.I.	9-15	0003503705	0907909	MERCEDES	7-38
0003401203	0287753	RENAULT V.I.	9-15	0003504405	0907634	MERCEDES	7-39
				0003504505	0907609	MERCEDES	7-39
				0003504605	0907622	MERCEDES	7-39
				0003504705	0907984	MERCEDES	7-39
				0003504805	0907840	MERCEDES	7-47
				000360098524	0807671	MERCEDES	7-45
				0004600148	0187146	MERCEDES	7-27

Cross Reference Guide

RIF. ORIG O.E. NUMBER	RIF. OCAP REF. OCAP	MARCA	PAG.	RIF. ORIG O.E. NUMBER	RIF. OCAP REF. OCAP	MARCA	PAG.
0004600148	0187146	MERCEDES BUS	16-10	0004606548	0182261	VEICOLI COMMERCIALI - LCV VEHICLE	1-36
0004600348	0186598	MERCEDES	7-27	0004606605	0507641	MERCEDES	7-23
0004600348	0186598	MERCEDES BUS	16-10	0004606748	0287907	MAN BUS	15-7
0004600648	0196598	MERCEDES	7-27	0004606748	0287907	MERCEDES BUS	16-11
0004600648	0196598	MERCEDES BUS	16-10	0004606848	0186551	MERCEDES	7-27
0004601005	0507970	MERCEDES	7-13	0004606948	0196961	MERCEDES	7-28
0004601105	0507970	MERCEDES	7-13	0004607048	0186551	MERCEDES	7-27
0004601248	0196598	MERCEDES	7-27	0004607105	0506585	MERCEDES	7-17
0004601248	0196598	MERCEDES BUS	16-10	0004607148	0196961	MERCEDES	7-28
0004601748	0187467	MERCEDES	7-28	0004607205	0506585	MERCEDES	7-17
0004602148	0180730	MERCEDES	7-25	0004607248	0182260	MERCEDES	7-25
0004602148	0180730	MERCEDES BUS	16-8	0004607248	0182260	MERCEDES BUS	16-8
0004602248	0186598	MERCEDES	7-27	0004607248	0182260	VEICOLI COMMERCIALI - LCV VEHICLE	1-36
0004602248	0186598	MERCEDES BUS	16-10	0004607748	0187137	MERCEDES BUS	16-10
0004602248	0190731	MERCEDES	7-29	0004607848	0197137	MERCEDES BUS	16-10
0004602648	0187146	MERCEDES	7-27	0004608348	0186424	MERCEDES	7-26
0004602648	0187146	MERCEDES BUS	16-10	0004608348	0186424	MERCEDES BUS	16-9
0004602705	0507695	MERCEDES	7-14	0004608448	0197971	MERCEDES	7-29
0004602748	0187146	MERCEDES	7-27	0004608505	0507977	MERCEDES	7-24
0004602748	0187146	MERCEDES BUS	16-10	0004608548	0180730	MERCEDES	7-25
0004602848	0186598	MERCEDES	7-27	0004608548	0180730	MERCEDES BUS	16-8
0004602848	0186598	MERCEDES BUS	16-10	0004608548	0180730	VEICOLI COMMERCIALI - LCV VEHICLE	1-43
0004602948	0186598	MERCEDES	7-27	0004608648	0190731	MERCEDES	7-29
0004602948	0186598	MERCEDES BUS	16-10	0004608648	0190731	VEICOLI COMMERCIALI - LCV VEHICLE	1-44
0004603448	0196598	MERCEDES	7-27	0004608748	0190731	MERCEDES	7-29
0004603448	0196598	MERCEDES BUS	16-10	0004608748	0190731	VEICOLI COMMERCIALI - LCV VEHICLE	1-44
0004603548	0196598	MERCEDES	7-27	0004608948	0186598	MERCEDES	7-27
0004603548	0196598	MERCEDES BUS	16-10	0004608948	0186598	MERCEDES BUS	16-10
0004604105	0507694	MERCEDES	7-24	0004609205	0507629	MERCEDES	7-17
0004604148	0180730	MERCEDES	7-25	0004609305	0507629	MERCEDES	7-17
0004604148	0180730	MERCEDES BUS	16-8	0004609505	0507967	MERCEDES	7-21
0004604148	0180730	VEICOLI COMMERCIALI - LCV VEHICLE	1-43	0004609805	0507627	MERCEDES	7-21
0004604248	0190731	MERCEDES	7-29	0004609905	0507627	MERCEDES	7-21
0004604248	0190731	VEICOLI COMMERCIALI - LCV VEHICLE	1-44	0004631129	0187342	MERCEDES BUS	16-9
0004604348	0180730	MERCEDES	7-25	0004632329	0287466	NEOPLAN BUS	17-5
0004604348	0180730	MERCEDES BUS	16-8	0004632629	0287466	NEOPLAN BUS	17-5
0004604348	0187342	MERCEDES	7-26	0004633229	0186595	MERCEDES	7-25
0004604348	0187342	MERCEDES BUS	16-9	0004633429	0186424	MERCEDES	7-26
0004604405	0507628	MERCEDES	7-23	0004633429	0186424	MERCEDES BUS	16-9
0004604542	0180730	MERCEDES	7-25	0004633529	0186424	MERCEDES	7-26
0004604548	0180730	MERCEDES BUS	16-8	0004633529	0186424	MERCEDES BUS	16-9
0004604648	0190731	MERCEDES	7-29	0004634429	0287361	MERCEDES	7-25
0004604648	0190731	VEICOLI COMMERCIALI - LCV VEHICLE	1-44	0004634429	0287361	MERCEDES BUS	16-8
0004604848	0187971	MERCEDES	7-29	0004634629	0287684	MERCEDES	7-26
0004604948	0287684	MERCEDES	7-26	0005860132	0907638	MERCEDES	7-34
0004605505	0507694	MERCEDES	7-24	0005860135	0907584	MERCEDES	7-41
0004605648	0187342	MERCEDES	7-26	0005860632	0907602	MERCEDES	7-35
0004605648	0187342	MERCEDES BUS	16-9	0005860732	0907836	MERCEDES	7-34
0004605748	0186551	MERCEDES	7-27	0005861035	0907621	MERCEDES	7-46
0004605848	0196961	MERCEDES	7-28	0005861135	0907304	MERCEDES	7-30
0004606005	0507971	MERCEDES	7-10	0005861235	0907330	MERCEDES	7-31
0004606048	0186551	MERCEDES	7-27	0005861433	0907556	MERCEDES	7-30
0004606148	0196961	MERCEDES	7-28	0005861533	0907586	IVECO BUS	14-7
0004606305	0507971	MERCEDES	7-10	0005861533	0907586	IVECO TRUCK	5-21
0004606548	0182261	MERCEDES BUS	16-8				

Cross Reference Guide

RIF. ORIG O.E. NUMBER	RIF. OCAP REF. OCAP	MARCA	PAG.	RIF. ORIG O.E. NUMBER	RIF. OCAP REF. OCAP	MARCA	PAG.
0005861533	0907586	MERCEDES	7-30	0014600648	0187971	MERCEDES	7-29
0005861533	0907586	NEOPLAN BUS	17-8	0014600705	0507968	MERCEDES	7-19
0005861633	0907601	MERCEDES	7-34	0014600748	0197971	MERCEDES	7-29
0005861733	0907602	MERCEDES	7-35	0014600805	0507968	MERCEDES	7-19
0005861833	0907584	MERCEDES	7-41	0014600848	0186598	MERCEDES	7-27
0005861933	0907584	MERCEDES	7-41	0014600848	0186598	MERCEDES BUS	16-10
0009964845	0287361	MERCEDES	7-25	0014600948	0186598	MERCEDES	7-27
0009964845	0287361	MERCEDES BUS	16-8	0014600948	0186598	MERCEDES BUS	16-10
0013300035	0196612	MERCEDES	7-26	0014601105	0507961	MERCEDES	7-11
0013300035	0196612	VEICOLI COMMERCIALI - LCV VEHICLE	1-48	0014601148	0186551	MERCEDES	7-27
				0014601248	0186598	MERCEDES	7-27
0013300135	0186424	MERCEDES	7-26	0014601248	0186598	MERCEDES BUS	16-10
0013300135	0186424	MERCEDES BUS	16-9	0014601305	0507911	MERCEDES	7-23
0013300135	0186424	NEOPLAN BUS	17-6	0014601348	0196961	MERCEDES	7-28
0013300235	0186424	MERCEDES	7-26	0014601405	0507911	MERCEDES	7-23
0013300235	0186424	MERCEDES BUS	16-9	0014601448	0196598	MERCEDES	7-27
0013300335	0186547	MERCEDES	7-27	0014601448	0196598	MERCEDES BUS	16-10
0013300335	0186547	MERCEDES BUS	16-9	0014601505	0507587	MERCEDES	7-11
0013300435	0186547	MERCEDES	7-27	0014601748	0186551	MERCEDES	7-27
0013300435	0186547	MERCEDES BUS	16-9	0014602048	0197137	MERCEDES BUS	16-10
0013300735	0180729	MERCEDES	7-29	0014602105	0507695	MERCEDES	7-14
0013300835	0190729	MERCEDES	7-29	0014602148	0187137	MERCEDES BUS	16-10
0013300935	0180729	MERCEDES	7-29	0014602205	0507695	MERCEDES	7-14
0013301035	0180729	MERCEDES	7-29	0014602248	0186598	MERCEDES	7-27
0013301235	0187560	MERCEDES	7-25	0014602248	0186598	MERCEDES BUS	16-10
0013301235	0187560	VEICOLI COMMERCIALI - LCV VEHICLE	1-45	0014602348	0196598	MERCEDES	7-27
				0014602348	0196598	MERCEDES BUS	16-10
0013301435	0187560	MERCEDES	7-25	0014602548	0196961	MERCEDES	7-28
0013301435	0187560	VEICOLI COMMERCIALI - LCV VEHICLE	1-45	0014602905	0506582	MERCEDES	7-14
				0014602948	0187916	MERCEDES	7-28
0013301835	0186599	MERCEDES	7-28	0014603005	0506582	MERCEDES	7-14
0013302135	0287136	MERCEDES	7-28	0014603448	0186424	MERCEDES	7-26
0013302135	0287136	MERCEDES BUS	16-11	0014603448	0186424	MERCEDES BUS	16-9
0013302135	0287136	NEOPLAN BUS	17-7	0014603748	0196598	MERCEDES	7-27
0013302235	0297136	MERCEDES	7-28	0014603748	0196598	MERCEDES BUS	16-10
0013302235	0297136	MERCEDES BUS	16-11	0014603848	0187959	MERCEDES	7-27
0013302235	0297136	NEOPLAN BUS	17-7	0014604148	0187789	MERCEDES	7-29
0013302635	0287136	MERCEDES	7-28	0014604205	0507829	MERCEDES	7-21
0013302635	0287136	MERCEDES BUS	16-11	0014604248	0187789	MERCEDES	7-29
0013302635	0287136	NEOPLAN BUS	17-7	0014604848	0187959	MERCEDES	7-27
0013302735	0297136	MERCEDES	7-28	0014604905	0507441	MERCEDES	7-20
0013302735	0297136	MERCEDES BUS	16-11	0014605048	0187789	MERCEDES	7-29
0013302735	0297136	NEOPLAN BUS	17-7	0014605148	0187959	MERCEDES	7-27
0013304835	0182260	MERCEDES	7-25	0014605305	0507440	MERCEDES	7-11
0013304835	0182260	MERCEDES BUS	16-8	0014605505	0507964	MERCEDES	7-23
0013304835	0182260	VEICOLI COMMERCIALI - LCV VEHICLE	1-36	0014605648	0187435	MERCEDES BUS	16-11
				0014605705	0507966	MERCEDES	7-12
0013308835	0196424	MERCEDES	7-27	0014606505	0507978	MERCEDES	7-13
0013308835	0196424	MERCEDES BUS	16-9	0014606705	0506585	MERCEDES	7-17
0014600005	0507633	MERCEDES	7-7	0014606905	0507629	MERCEDES	7-17
0014600105	0507633	MERCEDES	7-7	0014606948	0287360	MERCEDES BUS	16-8
0014600248	0186598	MERCEDES	7-27	0014607005	0507968	MERCEDES	7-19
0014600248	0186598	MERCEDES BUS	16-10	0014607048	0287361	MERCEDES	7-25
0014600305	0507594	MERCEDES	7-13	0014607048	0287361	MERCEDES BUS	16-8
0014600348	0196598	MERCEDES	7-27	0014607105	0507967	MERCEDES	7-21
0014600348	0196598	MERCEDES BUS	16-10	0014607305	0507587	MERCEDES	7-11
0014600405	0507594	MERCEDES	7-13	0014607405	0507441	MERCEDES	7-20
0014600448	0186551	MERCEDES	7-27	0014607448	0197146	MERCEDES BUS	16-10
0014600548	0196961	MERCEDES	7-28				

Cross Reference Guide

RIF. ORIG O.E. NUMBER	RIF. OCAP REF. OCAP	MARCA	PAG.	RIF. ORIG O.E. NUMBER	RIF. OCAP REF. OCAP	MARCA	PAG.
0014607548	0197146	MERCEDES BUS	16-10	0024607805	0507637	MERCEDES	7-22
0014607648	0186551	MERCEDES	7-27	0024609205	0507974	MERCEDES	7-22
0014607748	0186598	MERCEDES	7-27	0024609305	0507974	MERCEDES	7-22
0014607948	0196961	MERCEDES	7-28	0024609605	0507614	MERCEDES	7-14
0014608448	0187789	MERCEDES	7-29	0024609705	0507614	MERCEDES	7-14
0014608548	0187789	MERCEDES	7-29	0034600705	0507963	MERCEDES	7-20
0014608648	0187959	MERCEDES	7-27	0034601805	0507642	MERCEDES	7-19
0014608948	0187789	MERCEDES	7-29	0034601905	0507642	MERCEDES	7-19
0014609648	0186551	MERCEDES	7-27	0034602905	0507977	MERCEDES	7-24
0014609705	0507804	MERCEDES	7-15	0034603105	0507961	MERCEDES	7-11
0014609748	0186424	MERCEDES	7-26	0034603205	0507911	MERCEDES	7-23
0014609805	0507632	MERCEDES	7-16	0034603305	0507587	MERCEDES	7-11
0014609905	0507632	MERCEDES	7-16	0034603405	0507964	MERCEDES	7-23
0014609948	0187959	MERCEDES	7-27	0034603505	0507966	MERCEDES	7-12
0014632229	0186424	MERCEDES	7-26	0034603805	0507978	MERCEDES	7-13
0023123224	0506695	RENAULT V.I.	9-2	0034604005	0507912	MERCEDES	7-18
0023123230	0506695	RENAULT V.I.	9-2	0034604105	0507965	MERCEDES	7-22
0023123247	0506642	RENAULT V.I.	9-9	0034604205	0507962	MERCEDES	7-22
0023123251	0807745	RENAULT V.I.	9-16	0034604405	0507973	MERCEDES	7-19
0023123253	0807252	RENAULT V.I.	9-18	0034604505	0507974	MERCEDES	7-22
0023123262	0506689	RENAULT V.I.	9-4	0034604605	0507887	MERCEDES	7-20
0023123268	0507677	RENAULT V.I.	9-6	0034604705	0507963	MERCEDES	7-20
0023123269	0507677	RENAULT V.I.	9-6	0034604805	0507630	MERCEDES	7-18
0023123275	0807675	RENAULT V.I.	9-17	0034604905	0507631	MERCEDES	7-17
0023162046	0187228	RENAULT V.I.	9-25	0034605005	0507789	MERCEDES	7-21
0023301335	0186612	VEICOLI COMMERCIALI - LCV VEHICLE	1-48	0034605105	0507637	MERCEDES	7-22
0023301435	0196612	MERCEDES	7-26	0034605605	0507615	MERCEDES	7-20
0024600148	0186598	MERCEDES	7-27	0034605705	0507614	MERCEDES	7-14
0024600248	0196424	MERCEDES	7-27	0034605805	0507642	MERCEDES	7-19
0024600348	0196598	MERCEDES	7-27	0034605905	0507827	MERCEDES	7-20
0024600405	0507961	MERCEDES	7-11	0034606005	0507434	MERCEDES	7-20
0024600505	0507911	MERCEDES	7-23	0035603405	0507964	MERCEDES	7-23
0024600548	0187789	MERCEDES	7-29	004908	0507128	BREDAMENARINIBUS	12-1
0024600605	0507440	MERCEDES	7-11	004909	0507127	BREDAMENARINIBUS	12-1
0024600948	0287684	MERCEDES	7-26	0067354	0907327	DAF-LEYLAND DAF	3-16
0024601005	0507977	MERCEDES	7-24	0067389	0286428	DAF-LEYLAND DAF	3-10
0024601705	0507973	MERCEDES	7-19	0069600	0907487	DAF-LEYLAND DAF	3-15
0024604305	0507630	MERCEDES	7-18	0069867	0187146	DAF-LEYLAND DAF	3-9
0024604405	0507630	MERCEDES	7-18	0074607205	0506585	MERCEDES	7-17
0024604505	0507789	MERCEDES	7-21	0080521	0807489	DAF-LEYLAND DAF	3-15
0024604605	0507789	MERCEDES	7-21	0083380029	0196612	VEICOLI COMMERCIALI - LCV VEHICLE	1-48
0024604705	0507631	MERCEDES	7-17	0087932	0507924	BREDAMENARINIBUS	12-1
0024604805	0507631	MERCEDES	7-17	0087932	0507924	DAF-LEYLAND DAF	3-3
0024604905	0507615	MERCEDES	7-20	0087932	0507924	SCANIA	10-4
0024605005	0507615	MERCEDES	7-20	0094016	0506431	DAF-LEYLAND DAF	3-3
0024605105	0507912	MERCEDES	7-18	0094029	0506429	DAF-LEYLAND DAF	3-5
0024605205	0507912	MERCEDES	7-18	0094037	0507492	DAF-LEYLAND DAF	3-6
0024605305	0507584	MERCEDES	7-21	0094038	0506430	DAF-LEYLAND DAF	3-5
0024605405	0507584	MERCEDES	7-21	0094044	0507945	DAF-LEYLAND DAF	3-6
0024605905	0507965	MERCEDES	7-22	0094053	0507494	DAF-LEYLAND DAF	3-7
0024606005	0507965	MERCEDES	7-22	0094613	0507799	DAF-LEYLAND DAF	3-6
0024606105	0507962	MERCEDES	7-22	0098726	0507495	DAF-LEYLAND DAF	3-6
0024606205	0507962	MERCEDES	7-22	0100873	0927399	DAF-LEYLAND DAF	3-23
0024606405	0507632	MERCEDES	7-16	0110196	0196613	DAF-LEYLAND DAF	3-8
0024607505	0507973	MERCEDES	7-19	0110197	0186613	DAF-LEYLAND DAF	3-8
0024607605	0507973	MERCEDES	7-19	0117343	0506429	DAF-LEYLAND DAF	3-5
0024607705	0507637	MERCEDES	7-22	0118086	0927401	DAF-LEYLAND DAF	3-23



Cross Reference Guide

RIF. ORIG O.E. NUMBER	RIF. OCAP REF. OCAP	MARCA	PAG.	RIF. ORIG O.E. NUMBER	RIF. OCAP REF. OCAP	MARCA	PAG.
0122810	0186758	DAF-LEYLAND DAF	3-11	0606922	0296427	DAF-LEYLAND DAF	3-10
0161376	0187146	DAF-LEYLAND DAF	3-9	0606922	0296427	DAF BUS	13-1
0171215	0506431	DAF-LEYLAND DAF	3-3	0606923	0286427	DAF-LEYLAND DAF	3-10
0206137	0927398	DAF-LEYLAND DAF	3-23	0606923	0286427	DAF BUS	13-1
0267743	0807501	DAF-LEYLAND DAF	3-15	0607053	0196598	DAF-LEYLAND DAF	3-10
0273203	0287503	DAF-LEYLAND DAF	3-8	0607053	0196598	DAF BUS	13-1
0274878	0507945	DAF-LEYLAND DAF	3-6	0607073	0186758	DAF-LEYLAND DAF	3-11
0275962	0507800	DAF-LEYLAND DAF	3-1	0607073	0186758	MAN	6-13
0278665	0506816	SCANIA	10-6	0607073	0186758	MAN BUS	15-7
0283784	0186598	SCANIA	10-9	0607073	0186758	NEOPLAN BUS	17-7
0288281	0507934	DAF-LEYLAND DAF	3-2	0607073	0186758	SCANIA	10-9
0296110	0807507	DAF-LEYLAND DAF	3-16	0607451	0186613	DAF-LEYLAND DAF	3-8
0301369	0506939	SCANIA	10-2	0607452	0196613	DAF-LEYLAND DAF	3-8
0306981	0506918	SCANIA	10-7	0607453	0186613	DAF-LEYLAND DAF	3-8
0310977	0507725	SCANIA	10-2	0607981	0186598	DAF-LEYLAND DAF	3-10
03109774	0507725	SCANIA	10-2	0607981	0186598	DAF BUS	13-1
0310979	0296759	SCANIA	10-10	0607998	0196424	DAF-LEYLAND DAF	3-9
0310980	0286759	SCANIA	10-10	0607998	0196424	DAF BUS	13-1
0311300	0196424	DAF-LEYLAND DAF	3-9	0607999	0186424	DAF-LEYLAND DAF	3-9
0311300	0196424	DAF BUS	13-1	0607999	0186424	DAF BUS	13-1
0350270	0187230	SCANIA	10-20	0608000	0187146	DAF-LEYLAND DAF	3-9
0356310	0186960	VOLVO	11-16	0608122	0287519	DAF-LEYLAND DAF	3-12
0362413	0507799	DAF-LEYLAND DAF	3-6	0608123	0297519	DAF-LEYLAND DAF	3-13
0368541	0807509	DAF-LEYLAND DAF	3-17	0608530	0186595	DAF-LEYLAND DAF	3-8
0370875	0506919	SCANIA	10-5	0609634	0186758	DAF-LEYLAND DAF	3-11
0382774	0507188	SCANIA	10-3	0609634	0186758	MAN	6-13
0382780	0507727	SCANIA	10-3	0609634	0186758	MAN BUS	15-7
0386930	0187228	DAF-LEYLAND DAF	3-22	0609634	0186758	NEOPLAN BUS	17-7
0386930	0187228	SCANIA	10-20	0609634	0186758	SCANIA	10-9
0388941	0507775	SCANIA	10-3	0609643	0186758	DAF-LEYLAND DAF	3-11
03889417	0507775	SCANIA	10-3	0609643	0186758	MAN	6-13
0388942	0507732	SCANIA	10-8	0609643	0186758	MAN BUS	15-7
0389867	0507728	SCANIA	10-4	0609643	0186758	NEOPLAN BUS	17-7
03898673	0507728	SCANIA	10-4	0609643	0186758	SCANIA	10-9
0390784	0506913	SCANIA	10-5	0638680	0197523	DAF-LEYLAND DAF	3-12
03907847	0506913	SCANIA	10-5	0639370	0907528	SCANIA	10-11
0392418	0807513	DAF-LEYLAND DAF	3-16	0639370	0907528	SCANIA BUS	19-4
0395010	0186598	SCANIA	10-9	0646373	0807797	DAF-LEYLAND DAF	3-14
0395350	0506939	SCANIA	10-2	0649819	0807525	DAF-LEYLAND DAF	3-17
03953502	0506939	SCANIA	10-2	065472	0507131	BREDAMENARINIBUS	12-1
0415400	0507730	SCANIA BUS	19-1	065475	0507131	BREDAMENARINIBUS	12-1
043102	0507133	BREDAMENARINIBUS	12-2	065475.0	0507131	BREDAMENARINIBUS	12-1
043102.3	0507133	BREDAMENARINIBUS	12-2	0655695	0807797	DAF-LEYLAND DAF	3-14
0466336	0507998	SCANIA BUS	19-1	0655697	0807797	DAF-LEYLAND DAF	3-14
0466880	0509880	SCANIA BUS	19-2	0656084	0297229	DAF-LEYLAND DAF	3-22
0477889	0807451	SCANIA BUS	19-4	0658102	0807528	DAF-LEYLAND DAF	3-16
0513757	0907359	DAF-LEYLAND DAF	3-14	0680374	0927402	DAF-LEYLAND DAF	3-23
0548588	0927400	DAF-LEYLAND DAF	3-23	0681511	0927404	DAF-LEYLAND DAF	3-24
0554765	0506430	DAF-LEYLAND DAF	3-5	0681621	0927402	DAF-LEYLAND DAF	3-23
0586714	0186758	DAF-LEYLAND DAF	3-11	0681706	0927403	DAF-LEYLAND DAF	3-23
0586714	0186758	MAN	6-13	0689747	0907531	DAF-LEYLAND DAF	3-16
0586714	0186758	MAN BUS	15-7	0689748	0907528	DAF-LEYLAND DAF	3-17
0586714	0186758	NEOPLAN BUS	17-7	0689749	0907259	DAF-LEYLAND DAF	3-16
0586714	0186758	SCANIA	10-9	0691703	0907304	DAF-LEYLAND DAF	3-21
0586753	0186424	DAF-LEYLAND DAF	3-9	0691704	0907257	DAF-LEYLAND DAF	3-20
0586753	0186424	DAF BUS	13-1	0691709	0907359	DAF-LEYLAND DAF	3-14
0592106	0297229	DAF-LEYLAND DAF	3-22	0693778	0907556	DAF-LEYLAND DAF	3-14
0593883	0507939	DAF-LEYLAND DAF	3-3	0694298	0186424	DAF-LEYLAND DAF	3-9

Cross Reference Guide

RIF. ORIG O.E. NUMBER	RIF. OCAP REF. OCAP	MARCA	PAG.	RIF. ORIG O.E. NUMBER	RIF. OCAP REF. OCAP	MARCA	PAG.
0694298	0186424	DAF BUS	13-1	1088985	0507702	VOLVO	11-4
0694360	0186424	DAF-LEYLAND DAF	3-9	1094219	0509893	VOLVO	11-5
0694360	0186424	DAF BUS	13-1	1094334	0507720	VOLVO	11-5
0696225	0196598	DAF-LEYLAND DAF	3-10	1094466	0809909	VOLVO	11-19
0696225	0196598	DAF BUS	13-1	1094912	0507119	VOLVO	11-5
0696226	0186598	DAF-LEYLAND DAF	3-10	11013547	0907259	NEOPLAN BUS	17-9
0696226	0186598	DAF BUS	13-1	11015685	0196424	NEOPLAN BUS	17-6
0696226	0186758	DAF-LEYLAND DAF	3-11	11015686	0186424	NEOPLAN BUS	17-6
0696226	0186758	MAN	6-13	11015863	0807354	NEOPLAN BUS	17-8
0696226	0186758	MAN BUS	15-7	11019632	0507468	NEOPLAN BUS	17-1
0696226	0186758	NEOPLAN BUS	17-7	11019635	0507469	NEOPLAN BUS	17-2
0696226	0186758	SCANIA	10-9	11019641	0507470	NEOPLAN BUS	17-3
0696320	0907525	DAF-LEYLAND DAF	3-17	11019659	0186598	NEOPLAN BUS	17-6
0696321	0907529	DAF-LEYLAND DAF	3-17	11019661	0196598	NEOPLAN BUS	17-6
0697221	0187463	DAF-LEYLAND DAF	3-11	11019664	0507472	NEOPLAN BUS	17-3
0698450	0186598	DAF-LEYLAND DAF	3-10	11019692	0507474	NEOPLAN BUS	17-1
0698450	0186598	DAF BUS	13-1	11019859	0287361	NEOPLAN BUS	17-5
0698586	0187530	DAF-LEYLAND DAF	3-12	11019933	0187463	NEOPLAN BUS	17-7
0698609	0186424	DAF-LEYLAND DAF	3-9	11019966	0187476	NEOPLAN BUS	17-7
0698609	0186424	DAF BUS	13-1	11020274	0507477	NEOPLAN BUS	17-3
0698724	0907489	DAF-LEYLAND DAF	3-15	11020285	0507480	NEOPLAN BUS	17-3
070550504	0907259	NEOPLAN BUS	17-9	11020291	0507481	NEOPLAN BUS	17-1
0817824	0287291	DAF-LEYLAND DAF	3-8	11020292	0507482	NEOPLAN BUS	17-1
082192200	0196424	NEOPLAN BUS	17-6	1104334	0907528	SCANIA	10-11
082192300	0186424	NEOPLAN BUS	17-6	1104334	0907528	SCANIA BUS	19-4
082750900	0807354	NEOPLAN BUS	17-8	1104335	0907259	SCANIA	10-11
082750905	0907257	NEOPLAN BUS	17-9	1104336	0907529	SCANIA	10-16
082751027	0907623	MERCEDES	7-49	11100492	0297752	RENAULT V.I.	9-14
082751027	0907623	NEOPLAN BUS	17-13	11100521	0287752	RENAULT V.I.	9-14
082751110	0807357	NEOPLAN BUS	17-8	1112023	0507729	SCANIA	10-5
082756320	0807464	NEOPLAN BUS	17-9	1112511	0506936	SCANIA	10-5
0890991	0507798	DAF-LEYLAND DAF	3-3	11200265-0	0506588	NISSAN	8-1
093161371	0907586	IVECO BUS	14-7	11200360-0	0186592	NISSAN	8-3
093161371	0907586	IVECO TRUCK	5-21	11200361-0	0196592	NISSAN	8-3
093163617	0907927	IVECO TRUCK	5-33	11200454-0	0506590	NISSAN	8-2
094038	0506430	DAF-LEYLAND DAF	3-5	112506	0907528	SCANIA	10-11
100873	0927399	DAF-LEYLAND DAF	3-23	112506	0907528	SCANIA BUS	19-4
10391031	0281725	VEICOLI COMMERCIALI - LCV VEHICLE	1-24	1127452	0507244	VOLVO	11-12
1047145	0281725	VEICOLI COMMERCIALI - LCV VEHICLE	1-24	1130567	0507706	VOLVO	11-4
1055194	0401127	VEICOLI COMMERCIALI - LCV VEHICLE	1-24	1131741	0296964	VOLVO	11-16
1071169	0507117	VOLVO	11-5	1131741	0296964	VOLVO BUS	20-5
1071315	0507122	VOLVO	11-11	1131742	0286964	VOLVO	11-16
1071344	0507118	VOLVO	11-10	1131742	0286964	VOLVO BUS	20-4
1075005	0507107	VOLVO	11-8	1131744	0196960	VOLVO	11-16
1075006	0507108	VOLVO	11-8	1131744	0196960	VOLVO BUS	20-4
1075153	0507112	VOLVO	11-10	1132493	0187228	VOLVO	11-26
1075663	0507111	VOLVO	11-7	1134840	0507679	VOLVO	11-12
1075664	0507120	VOLVO	11-8	1135080	0907224	VOLVO	11-20
1076639	0807762	VOLVO	11-20	1135630	0507244	VOLVO	11-12
1080690	0807221	VOLVO	11-18	1138275	0283867	VEICOLI COMMERCIALI - LCV VEHICLE	1-26
1080786	0507114	VOLVO	11-6	1143319	0507930	DAF-LEYLAND DAF	3-3
1080787	0507106	VOLVO	11-6	1143322	0507943	DAF-LEYLAND DAF	3-5
1080788	0507105	VOLVO	11-6	1143324	0507946	DAF-LEYLAND DAF	3-7
1080792	0507708	VOLVO	11-2	1144018	0507930	DAF-LEYLAND DAF	3-3
1082104	0807222	VOLVO	11-20	1149907	0186598	DAF-LEYLAND DAF	3-10
1083744	0507693	VOLVO	11-7	11505036-0	0506591	NISSAN	8-2
				1152350	0186598	DAF-LEYLAND DAF	3-10

Cross Reference Guide

RIF. ORIG O.E. NUMBER	RIF. OCAP REF. OCAP	MARCA	PAG.	RIF. ORIG O.E. NUMBER	RIF. OCAP REF. OCAP	MARCA	PAG.
1152427	0507945	DAF-LEYLAND DAF	3-6	1235514	0287724	DAF-LEYLAND DAF	3-11
1164684	0509912	RENAULT V.I.	9-1	1235515	0297724	DAF-LEYLAND DAF	3-11
118086	0927401	DAF-LEYLAND DAF	3-23	1243618	0907997	DAF-LEYLAND DAF	3-20
1190778	0186595	VOLVO	11-14	1247956	0506435	DAF-LEYLAND DAF	3-5
1191900	0507946	DAF-LEYLAND DAF	3-7	1247957	0506434	DAF-LEYLAND DAF	3-4
11926	0186598	NEOPLAN BUS	17-6	1249088	0297229	DAF-LEYLAND DAF	3-22
11927	0196598	NEOPLAN BUS	17-6	1249129	0287229	DAF-LEYLAND DAF	3-22
1193034	0507943	DAF-LEYLAND DAF	3-5	1257890	0186598	DAF-LEYLAND DAF	3-10
1194390	0507719	VOLVO	11-2	1257890	0186598	DAF BUS	13-1
1194824	0507680	VOLVO	11-6	1257991	0507784	DAF-LEYLAND DAF	3-4
1196631	0509904	VOLVO BUS	20-7	1257992	0507944	DAF-LEYLAND DAF	3-3
1197338	0507692	VOLVO BUS	20-2	1261101	0807555	DAF-LEYLAND DAF	3-14
1197339	0509882	SCANIA BUS	19-1	1270853	0507933	DAF-LEYLAND DAF	3-2
1197339	0509882	VOLVO BUS	20-2	1270854	0507934	DAF-LEYLAND DAF	3-2
120110403	0187465	NEOPLAN BUS	17-5	1271124	0907258	DAF-LEYLAND DAF	3-14
120110404	0287466	NEOPLAN BUS	17-5	1271126	0289923	DAF-LEYLAND DAF	3-8
120164610	0287291	NEOPLAN BUS	17-5	1271126	0289923	IVECO TRUCK	5-16
120322300	0197467	NEOPLAN BUS	17-7	1271126	0289923	MAN	6-11
120322305	0187467	NEOPLAN BUS	17-7	1271126	0289923	VOLVO	11-14
120322809	0507468	NEOPLAN BUS	17-1	1278679	0187228	SCANIA	10-20
120322812	0507469	NEOPLAN BUS	17-2	1283211	0506435	DAF-LEYLAND DAF	3-5
120323000	0507470	NEOPLAN BUS	17-3	1283212	0506434	DAF-LEYLAND DAF	3-4
120324001	0186612	NEOPLAN BUS	17-5	1284860	0807797	DAF-LEYLAND DAF	3-14
120324002	0196612	NEOPLAN BUS	17-5	1286342	0507800	DAF-LEYLAND DAF	3-1
120324500	0507471	NEOPLAN BUS	17-2	1286343	0506432	DAF-LEYLAND DAF	3-1
120325000	0186598	NEOPLAN BUS	17-6	1291060	0506433	DAF-LEYLAND DAF	3-6
120325100	0196424	NEOPLAN BUS	17-6	1294251	0807927	DAF-LEYLAND DAF	3-15
120325101	0186424	NEOPLAN BUS	17-6	1295415	0507931	DAF-LEYLAND DAF	3-2
120325200	0196598	NEOPLAN BUS	17-6	1297572	0507942	DAF-LEYLAND DAF	3-1
120325500	0507472	NEOPLAN BUS	17-3	1300284	0507781	SCANIA	10-4
120325701	0186613	NEOPLAN BUS	17-5	1300473080	0401138	IVECO TRUCK	5-34
120325702	0196613	NEOPLAN BUS	17-5	1300473080	0401138	VEICOLI COMMERCIALI - LCV VEHICLE	1-2
120325800	0507473	NEOPLAN BUS	17-3	1300716080	0181602	VEICOLI COMMERCIALI - LCV VEHICLE	1-3
120326000	0187146	NEOPLAN BUS	17-6	1300720080	1215491	VEICOLI COMMERCIALI - LCV VEHICLE	1-17
120326100	0187342	NEOPLAN BUS	17-5	1302368080	0401137	IVECO TRUCK	5-34
120326200	0197342	MERCEDES BUS	16-9	1302368080	0401137	VEICOLI COMMERCIALI - LCV VEHICLE	1-1
120326200	0197342	NEOPLAN BUS	17-6	1304569	0506919	SCANIA	10-5
120326400	0187571	NEOPLAN BUS	17-6	1304571	0506869	SCANIA	10-6
120328300	0507474	NEOPLAN BUS	17-1	1305012	0507737	SCANIA	10-4
1203.223.00	0197467	MERCEDES	7-28	1306003080	0280037	VEICOLI COMMERCIALI - LCV VEHICLE	1-7
1205248	0297796	DAF-LEYLAND DAF	3-11	1306716080	0281143	IVECO TRUCK	5-18
1208073	0907508	DAF-LEYLAND DAF	3-16	1306716080	0281143	VEICOLI COMMERCIALI - LCV VEHICLE	1-1
122162800	0287361	NEOPLAN BUS	17-5	1308600080	0391141	VEICOLI COMMERCIALI - LCV VEHICLE	1-2
122169000	0187463	NEOPLAN BUS	17-7	1308601080	0381141	VEICOLI COMMERCIALI - LCV VEHICLE	1-1
122169100	0197463	NEOPLAN BUS	17-7	1308643	0506916	SCANIA	10-8
122169500	0187476	NEOPLAN BUS	17-7	13086434	0506916	SCANIA	10-8
122350000	0507477	NEOPLAN BUS	17-3	1308664080 *	0181322-K	VEICOLI COMMERCIALI - LCV VEHICLE	1-7
122351400	0807478	NEOPLAN BUS	17-8	1308759080	0391140	VEICOLI COMMERCIALI - LCV VEHICLE	1-3
122351500	0507479	NEOPLAN BUS	17-4	1308760080	0381140	VEICOLI COMMERCIALI - LCV VEHICLE	1-2
122351600	0507480	NEOPLAN BUS	17-3	1310760	0199928	DAF-LEYLAND DAF	3-11
122352700	0507481	NEOPLAN BUS	17-1				
122352720	0507482	NEOPLAN BUS	17-1				
122352740	0507483	NEOPLAN BUS	17-1				
1228114	0186613	DAF-LEYLAND DAF	3-8				
1228115	0196598	DAF-LEYLAND DAF	3-10				
1228115	0196598	DAF BUS	13-1				
1229944	0186424	DAF-LEYLAND DAF	3-9				
1229944	0186424	DAF BUS	13-1				

Cross Reference Guide

RIF. ORIG O.E. NUMBER	RIF. OCAP REF. OCAP	MARCA	PAG.	RIF. ORIG O.E. NUMBER	RIF. OCAP REF. OCAP	MARCA	PAG.
1311025080 *	0181322-K	VEICOLI COMMERCIALI - LCV VEHICLE	1-7	1331940080	0381446	VEICOLI COMMERCIALI - LCV VEHICLE	1-2
1311048	0507932	DAF-LEYLAND DAF	3-6	1333754080	0391184	VEICOLI COMMERCIALI - LCV VEHICLE	1-7
1313056080 *	0181322-K	VEICOLI COMMERCIALI - LCV VEHICLE	1-7	1333755080	0381184	VEICOLI COMMERCIALI - LCV VEHICLE	1-7
1313083080	0391184	VEICOLI COMMERCIALI - LCV VEHICLE	1-7	1337366	0196758	SCANIA	10-9
1313084080	0381184	VEICOLI COMMERCIALI - LCV VEHICLE	1-7	1337367	0186758	MAN	6-13
1313744	0196960	VOLVO	11-16	1337367	0186758	MAN BUS	15-7
1315447	0196424	DAF-LEYLAND DAF	3-9	1337367	0186758	NEOPLAN BUS	17-7
1315447	0196424	DAF BUS	13-1	1337644	0507934	SCANIA	10-9
1315530	0507940	DAF-LEYLAND DAF	3-7	1337644	0507934	DAF-LEYLAND DAF	3-2
1315878	0287881	MERCEDES BUS	16-9	1338714	0196424	DAF-LEYLAND DAF	3-9
1316735080	0391184	VEICOLI COMMERCIALI - LCV VEHICLE	1-7	1338714	0196424	DAF BUS	13-1
1316736080	0381184	VEICOLI COMMERCIALI - LCV VEHICLE	1-7	1338769	0807771	SCANIA	10-11
1316872	0507737	SCANIA	10-4	1339464080	0391451	VEICOLI COMMERCIALI - LCV VEHICLE	1-3
1317238080	0391140	VEICOLI COMMERCIALI - LCV VEHICLE	1-3	1339465080	0391446	VEICOLI COMMERCIALI - LCV VEHICLE	1-2
1317239080	0381140	VEICOLI COMMERCIALI - LCV VEHICLE	1-2	1339466080	0381451	VEICOLI COMMERCIALI - LCV VEHICLE	1-3
1317240080	0391141	VEICOLI COMMERCIALI - LCV VEHICLE	1-2	1339467080	0381446	VEICOLI COMMERCIALI - LCV VEHICLE	1-2
1317241080	0381141	VEICOLI COMMERCIALI - LCV VEHICLE	1-1	1341019080 *	0602637	VEICOLI COMMERCIALI - LCV VEHICLE	1-5
1317389080	0391184	VEICOLI COMMERCIALI - LCV VEHICLE	1-7	1342026	0186424	DAF-LEYLAND DAF	3-9
1317390080	0381184	VEICOLI COMMERCIALI - LCV VEHICLE	1-7	1343262	0507999	SCANIA	10-3
1319838	0196424	DAF-LEYLAND DAF	3-9	1343264	0509879	SCANIA	10-8
1319838	0196424	DAF BUS	13-1	1343266	0507767	SCANIA	10-3
1320755080	0391140	VEICOLI COMMERCIALI - LCV VEHICLE	1-3	1343278	0509884	SCANIA	10-8
1320756080	0381140	VEICOLI COMMERCIALI - LCV VEHICLE	1-2	1343283	0507766	SCANIA	10-3
1320786080	0391141	VEICOLI COMMERCIALI - LCV VEHICLE	1-2	1344684	0289927	DAF-LEYLAND DAF	3-9
1320787080	0381141	VEICOLI COMMERCIALI - LCV VEHICLE	1-1	1345854080 *	0602637	VEICOLI COMMERCIALI - LCV VEHICLE	1-5
1320855	0186424	DAF-LEYLAND DAF	3-9	1346489	0507941	DAF-LEYLAND DAF	3-7
1321936	0907927	DAF-LEYLAND DAF	3-15	1348269	0509881	SCANIA	10-7
1322663080	0391184	VEICOLI COMMERCIALI - LCV VEHICLE	1-7	1350658080 Z	0182638	VEICOLI COMMERCIALI - LCV VEHICLE	1-6
1322664080	0381184	VEICOLI COMMERCIALI - LCV VEHICLE	1-7	1351714	0506435	DAF-LEYLAND DAF	3-5
1324483	0507737	SCANIA	10-4	1351718	0507784	DAF-LEYLAND DAF	3-4
1326771	0807454	SCANIA	10-11	1351720	0507941	DAF-LEYLAND DAF	3-7
1326775	0807454	SCANIA	10-11	1351730	0507939	DAF-LEYLAND DAF	3-3
1326896	0186424	DAF-LEYLAND DAF	3-9	1351731	0507940	DAF-LEYLAND DAF	3-7
1329134	0196598	DAF-LEYLAND DAF	3-10	1351732	0507944	DAF-LEYLAND DAF	3-3
1329134	0196598	DAF BUS	13-1	1351734	0506433	DAF-LEYLAND DAF	3-6
1331640080	0401446	IVECO TRUCK	5-34	1351737	0507932	DAF-LEYLAND DAF	3-6
1331640080	0401446	VEICOLI COMMERCIALI - LCV VEHICLE	1-2	1351745	0507939	DAF-LEYLAND DAF	3-3
1331641080	0401451	IVECO TRUCK	5-34	1352225080	0382638	VEICOLI COMMERCIALI - LCV VEHICLE	1-5
1331641080	0401451	VEICOLI COMMERCIALI - LCV VEHICLE	1-3	1352226080	0382639	VEICOLI COMMERCIALI - LCV VEHICLE	1-6
1331937080	0391451	VEICOLI COMMERCIALI - LCV VEHICLE	1-3	1352227080	0392638	VEICOLI COMMERCIALI - LCV VEHICLE	1-5
1331938080	0391446	VEICOLI COMMERCIALI - LCV VEHICLE	1-2	1352228080	0392639	VEICOLI COMMERCIALI - LCV VEHICLE	1-6
1331939080	0381451	VEICOLI COMMERCIALI - LCV VEHICLE	1-3	1353391	0507933	DAF-LEYLAND DAF	3-2
				1353396	0506432	DAF-LEYLAND DAF	3-1
				1353400	0507931	DAF-LEYLAND DAF	3-2
				1353445	0807997	SCANIA	10-12
				1355449080 Z	0503520	VEICOLI COMMERCIALI - LCV VEHICLE	1-6
				1356055	0506920	SCANIA	10-7



Cross Reference Guide

RIF. ORIG O.E. NUMBER	RIF. OCAP REF. OCAP	MARCA	PAG.	RIF. ORIG O.E. NUMBER	RIF. OCAP REF. OCAP	MARCA	PAG.
1357572080 Z	0182638	VEICOLI COMMERCIALI - LCV VEHICLE	1-6	1395614	0507723	SCANIA	10-8
1357674	0187723	SCANIA	10-10	1395994	0507947	DAF-LEYLAND DAF	3-5
1358792	0196598	SCANIA	10-9	1397866	0506939	SCANIA	10-2
1358792	0196598	SCANIA BUS	19-3	1398368	0907926	DAF-LEYLAND DAF	3-19
1358793	0186598	SCANIA	10-9	1399180	0807771	SCANIA	10-11
1358793	0186598	SCANIA BUS	19-3	1399724	0287503	DAF-LEYLAND DAF	3-8
1361155	0507942	DAF-LEYLAND DAF	3-1	1400099680	0502735	VEICOLI COMMERCIALI - LCV VEHICLE	1-10
1361157	0507931	DAF-LEYLAND DAF	3-2	1401381380	0602733	VEICOLI COMMERCIALI - LCV VEHICLE	1-9
1361413	0507723	SCANIA	10-8	1401940	0507928	DAF-LEYLAND DAF	3-5
1361650	0807501	DAF-LEYLAND DAF	3-15	1401942	0197928	DAF-LEYLAND DAF	3-10
1361651	0807489	DAF-LEYLAND DAF	3-15	1401944	0189926	DAF-LEYLAND DAF	3-9
1361652	0807930	DAF-LEYLAND DAF	3-18	1405655	0507928	DAF-LEYLAND DAF	3-5
1363858	0507935	DAF-LEYLAND DAF	3-4	1406025	0507928	DAF-LEYLAND DAF	3-5
1363859	0507948	DAF-LEYLAND DAF	3-4	1407144	0507928	DAF-LEYLAND DAF	3-5
1363964	0507779	SCANIA	10-1	1407394	0196424	DAF-LEYLAND DAF	3-9
1363984	0507779	SCANIA	10-1	1407394	0196424	DAF BUS	13-1
1367628	0507733	SCANIA	10-8	1407963	0506168	DAF-LEYLAND DAF	3-1
1367641	0507733	SCANIA	10-8	1408040	0506167	DAF-LEYLAND DAF	3-1
1368270	0807489	DAF-LEYLAND DAF	3-15	1409918	0506937	SCANIA	10-1
1369411	0506937	SCANIA	10-1	1412254	0507124	VOLVO	11-2
1369917	0507188	SCANIA	10-3	1417351	0403867	VEICOLI COMMERCIALI - LCV VEHICLE	1-26
1369919	0506919	SCANIA	10-5	1427727	0507243	SCANIA	10-20
1371228	0793867	VEICOLI COMMERCIALI - LCV VEHICLE	1-27	1428349	0807454	SCANIA	10-11
1371231	0783867	VEICOLI COMMERCIALI - LCV VEHICLE	1-27	1431471	0807451	SCANIA BUS	19-4
1373135	0186613	DAF-LEYLAND DAF	3-8	1431710	0807901	SCANIA BUS	19-4
1373137	0196613	DAF-LEYLAND DAF	3-8	1435944	0907362	SCANIA BUS	19-4
1375228	0287684	SCANIA	10-9	1438253	0783867	VEICOLI COMMERCIALI - LCV VEHICLE	1-27
1376730	0907297	DAF-LEYLAND DAF	3-20	1438254	0793867	VEICOLI COMMERCIALI - LCV VEHICLE	1-27
1378435	0506939	SCANIA	10-2	1438475	0807452	SCANIA BUS	19-4
1378436	0507779	SCANIA	10-1	1445656	0907925	DAF-LEYLAND DAF	3-19
1379071	0506920	SCANIA	10-7	1448062	0507935	DAF-LEYLAND DAF	3-4
1379168	0506937	SCANIA	10-1	1448063	0507948	DAF-LEYLAND DAF	3-4
1380417	0507938	DAF-LEYLAND DAF	3-4	1450364	0507996	SCANIA BUS	19-1
1383405	0187231	SCANIA	10-20	1451118	0507937	DAF-LEYLAND DAF	3-4
1384025	0506920	SCANIA	10-7	1451122	0507936	DAF-LEYLAND DAF	3-7
1384027	0507731	SCANIA	10-7	1451129	0507938	DAF-LEYLAND DAF	3-4
1384896	0507243	SCANIA	10-20	1451917	0403867	VEICOLI COMMERCIALI - LCV VEHICLE	1-26
1384897	0297229	SCANIA	10-20	1455327	0509890	SCANIA BUS	19-7
1384898	0287229	SCANIA	10-20	1464611	0807997	SCANIA	10-12
1385251	0506937	SCANIA	10-1	1471654080	0601139	VEICOLI COMMERCIALI - LCV VEHICLE	1-1
1385488	0507939	DAF-LEYLAND DAF	3-3	1471655080	0281143	VEICOLI COMMERCIALI - LCV VEHICLE	1-1
1385490	0507944	DAF-LEYLAND DAF	3-3	1479122	0507995	SCANIA BUS	19-2
1385492	0506434	DAF-LEYLAND DAF	3-4	1495683	0783867	VEICOLI COMMERCIALI - LCV VEHICLE	1-27
1385493	0507784	DAF-LEYLAND DAF	3-4	1495684	0793867	VEICOLI COMMERCIALI - LCV VEHICLE	1-27
1385497	0506435	DAF-LEYLAND DAF	3-5	1495685	0503254	VEICOLI COMMERCIALI - LCV VEHICLE	1-28
1385498	0507932	DAF-LEYLAND DAF	3-6	1497407080	0382734	VEICOLI COMMERCIALI - LCV VEHICLE	1-9
1385499	0506433	DAF-LEYLAND DAF	3-6	1497408080	0392734	VEICOLI COMMERCIALI - LCV VEHICLE	1-9
1385506	0507940	DAF-LEYLAND DAF	3-7	1497552080	0602733	VEICOLI COMMERCIALI - LCV VEHICLE	1-9
1385513	0507941	DAF-LEYLAND DAF	3-7				
1389190	0187843	DAF-LEYLAND DAF	3-11				
1390932	0807489	DAF-LEYLAND DAF	3-15				
1392640	0507936	DAF-LEYLAND DAF	3-7				
1394443	0287361	SCANIA	10-9				
1394444	0287360	SCANIA	10-9				
1394446	0287906	IVECO TRUCK	5-16				
1394884	0507726	SCANIA	10-3				

Cross Reference Guide

RIF. ORIG O.E. NUMBER	RIF. OCAP REF. OCAP	MARCA	PAG.	RIF. ORIG O.E. NUMBER	RIF. OCAP REF. OCAP	MARCA	PAG.
1498132	0907846	MAN	6-22	1592959	0507114	VOLVO	11-6
1501030	0506937	SCANIA	10-1	1598588	0907222	VOLVO	11-20
1505758	0196959	VOLVO	11-15	1599175	0507895	VOLVO	11-13
1505759	0186959	VOLVO	11-15	1602820	0507935	DAF-LEYLAND DAF	3-4
1505855	0507109	VOLVO	11-1	1602821	0507948	DAF-LEYLAND DAF	3-4
1505857	0506966	VOLVO	11-4	1603418	0199928	DAF-LEYLAND DAF	3-11
1506269	0186948	VOLVO	11-15	1603789	0186598	DAF-LEYLAND DAF	3-10
1506924	0589888	SCANIA BUS	19-7	1603883	0187723	DAF-LEYLAND DAF	3-12
1506925	0599888	SCANIA BUS	19-7	1604247	0197929	DAF-LEYLAND DAF	3-12
1507260	0507771	SCANIA	10-7	1604248	0187929	DAF-LEYLAND DAF	3-12
1507822	0196959	VOLVO	11-15	1605035	0807222	VOLVO	11-20
1507823	0186959	VOLVO	11-15	1606200	0807221	VOLVO	11-18
1507826	0186960	SCANIA BUS	19-3	1606274	0507109	VOLVO	11-1
1507826	0186960	VOLVO	11-16	1606276	0507716	VOLVO	11-1
1507826	0186960	VOLVO BUS	20-4	1606277	0506965	VOLVO	11-4
1509222	0807221	VOLVO	11-18	1606282	0507103	VOLVO	11-11
1514274	0807901	SCANIA BUS	19-4	1606283	0506969	VOLVO	11-9
1515981	0907919	SCANIA	10-17	1606284	0507102	VOLVO	11-9
1517279	0196613	VOLVO	11-14	1606551	0807762	VOLVO	11-20
1517403	0907528	SCANIA	10-11	1606552	0807544	VOLVO	11-18
1517403	0907528	SCANIA BUS	19-4	1606897	0509896	VOLVO	11-2
1517439	0196613	VOLVO	11-14	1606980	0287684	VOLVO	11-14
1517440	0186613	VOLVO	11-14	1607079	0807687	VOLVO	11-19
1517444	0186613	VOLVO	11-14	1607483	0287457	VOLVO	11-14
1517448	0196595	VOLVO	11-14	1608953	0507106	VOLVO	11-6
1517448	0196595	VOLVO BUS	20-4	1608954	0507105	VOLVO	11-6
1517449	0186595	VOLVO	11-14	1610074	0507104	VOLVO	11-6
1517452	0186595	VOLVO	11-14	1610338	0506967	VOLVO	11-6
1517577	0186424	VOLVO	11-15	1611864	0507109	VOLVO	11-1
1517647	0196424	VOLVO	11-15	1611880	0507718	VOLVO	11-7
1518142	0186595	VOLVO	11-14	1612254	0509896	VOLVO	11-2
1518142	0186595	VOLVO BUS	20-4	1612779	0507703	VOLVO	11-13
1527234	0187241	VOLVO	11-26	1612781	0507706	VOLVO	11-4
15503811 *	0181322-K	VEICOLI COMMERCIALI - LCV VEHICLE	1-7	1612857	0507704	VOLVO	11-13
1553239	0783867	VEICOLI COMMERCIALI - LCV VEHICLE	1-27	1612858	0507705	VOLVO	11-13
1553250	0793867	VEICOLI COMMERCIALI - LCV VEHICLE	1-27	1613351	0507895	VOLVO	11-13
1571862	0507716	VOLVO	11-1	1613562	0506968	VOLVO	11-7
1575690	0507720	VOLVO	11-5	16170096	0807489	DAF-LEYLAND DAF	3-15
1576092	0506969	VOLVO	11-9	1618048	0186598	DAF-LEYLAND DAF	3-10
1576093	0507102	VOLVO	11-9	1620436	0807930	DAF-LEYLAND DAF	3-18
1576816	0507103	VOLVO	11-11	1620438	0807797	DAF-LEYLAND DAF	3-14
1576952	0807221	VOLVO	11-18	1624093	0287457	VOLVO	11-14
1576953	0807529	VOLVO	11-21	1626492	0506966	VOLVO	11-4
1577080	0506966	VOLVO	11-4	1626493	0506965	VOLVO	11-4
1577081	0507245	VOLVO	11-5	1626494	0507109	VOLVO	11-1
1581527	0807687	VOLVO	11-19	1626494	0507109	VOLVO BUS	20-1
1584620	0506965	VOLVO	11-4	1626497	0507109	VOLVO	11-1
1587489	0507103	VOLVO	11-11	1626637	0507124	VOLVO	11-2
1588017	0506966	VOLVO	11-4	1626670	0507718	VOLVO	11-7
1588018	0507245	VOLVO	11-5	16266702	0507718	VOLVO	11-7
1588263	0506965	VOLVO	11-4	1626671	0507895	VOLVO	11-13
1590068	0809908	VOLVO	11-19	1626672	0507680	VOLVO	11-6
1592939	0507101	VOLVO	11-7	1626749	0506968	VOLVO	11-7
15929391	0507101	VOLVO	11-7	1626750	0507104	VOLVO	11-6
1592940	0507100	VOLVO	11-7	1626751	0506967	VOLVO	11-6
15929409	0507100	VOLVO	11-7	1626896	0807762	VOLVO	11-20
				1626957	0807690	VOLVO	11-17
				1626958	0807690	VOLVO	11-17

Cross Reference Guide

RIF. ORIG O.E. NUMBER	RIF. OCAP REF. OCAP	MARCA	PAG.	RIF. ORIG O.E. NUMBER	RIF. OCAP REF. OCAP	MARCA	PAG.
1628635	0509891	VOLVO	11-9	1705908	0197929	DAF-LEYLAND DAF	3-12
1628636	0507113	VOLVO	11-10	171419811	0280886	VEICOLI COMMERCIALI - LCV VEHICLE	1-93
1629668	0807691	VOLVO	11-17	1723895	0506937	SCANIA	10-1
1629734	0807762	VOLVO	11-20	1723897	0187894	SCANIA	10-9
1668179	0187456	VOLVO	11-26	1732635	0509879	SCANIA	10-8
1668638	0187241	VOLVO	11-26	1733471	0509885	SCANIA	10-8
1669010	0187456	VOLVO	11-26	1734019	0507723	SCANIA	10-8
1672152	0187228	VOLVO	11-26	1734020	0506939	SCANIA	10-2
1689604	0186608	DAF-LEYLAND DAF	3-8	1737683	0506937	SCANIA	10-1
1689605	0196608	DAF-LEYLAND DAF	3-8	1738379	0187723	SCANIA	10-10
1695511	0196613	VOLVO	11-14	1738380	0196598	SCANIA	10-9
1695585	0186960	SCANIA BUS	19-3	1738380	0196598	SCANIA BUS	19-3
1695585	0186960	VOLVO	11-16	1738381	0186598	SCANIA	10-9
1695585	0186960	VOLVO BUS	20-4	1738381	0186598	SCANIA BUS	19-3
1695689	0196424	VOLVO	11-15	1747467	0509885	SCANIA	10-8
1695690	0186424	VOLVO	11-15	1751418	0509890	SCANIA BUS	19-7
1695776	0186960	SCANIA BUS	19-3	1755498	0507995	SCANIA BUS	19-2
1695776	0186960	VOLVO	11-16	1755502	0507996	SCANIA BUS	19-1
1695776	0186960	VOLVO BUS	20-4	1759690	0507767	SCANIA	10-3
1696057	0186424	VOLVO	11-15	1759691	0507766	SCANIA	10-3
1696684	0297229	VOLVO	11-26	1763713	0403867	VEICOLI COMMERCIALI - LCV VEHICLE	1-26
1696684	0297229	VOLVO BUS	20-8	1763714	0503254	VEICOLI COMMERCIALI - LCV VEHICLE	1-28
1696685	0287229	VOLVO	11-26	1763991	0603867	VEICOLI COMMERCIALI - LCV VEHICLE	1-29
1696685	0287229	VOLVO BUS	20-8	1766014	0509886	SCANIA	10-19
1696900	0296964	VOLVO	11-16	1766014	0509886	SCANIA BUS	19-7
1696900	0296964	VOLVO BUS	20-5	1766015	0509889	SCANIA BUS	19-7
1696901	0286964	VOLVO	11-16	1767328	0186598	SCANIA	10-9
1696901	0286964	VOLVO BUS	20-4	1767328	0186598	SCANIA BUS	19-3
1696919	0186612	VOLVO	11-14	1768898	0506920	SCANIA	10-7
1696920	0196612	VOLVO	11-15	1769597	0507731	SCANIA	10-7
1697246	0186948	VOLVO	11-15	1785340	0187894	DAF-LEYLAND DAF	3-11
1697247	0186424	VOLVO	11-15	1789082	0509890	SCANIA BUS	19-7
1698047	0186948	VOLVO	11-15	1793876	0807930	DAF-LEYLAND DAF	3-18
1698190	0196613	VOLVO	11-14	1796671	0807455	SCANIA BUS	19-4
1698191	0186613	VOLVO	11-14	1817754	0403867	VEICOLI COMMERCIALI - LCV VEHICLE	1-26
1698532	0186959	VOLVO	11-15	1847311	0506920	SCANIA	10-7
1698533	0196959	VOLVO	11-15	1847312	0507731	SCANIA	10-7
1698557	0186960	SCANIA BUS	19-3	1863130	0807452	SCANIA BUS	19-4
1698557	0186960	VOLVO	11-16	1869413	0507999	SCANIA	10-3
1698557	0186960	VOLVO BUS	20-4	1877332	0783868	VEICOLI COMMERCIALI - LCV VEHICLE	1-29
1698558	0196960	VOLVO	11-16	1877334	0793868	VEICOLI COMMERCIALI - LCV VEHICLE	1-29
1698558	0196960	VOLVO BUS	20-4	1895858	0507995	SCANIA BUS	19-2
1698839	0196424	VOLVO	11-15	1895860	0507996	SCANIA BUS	19-1
1698840	0196960	VOLVO	11-16	189716	0186598	BREDAMENARINIBUS	12-3
1698840	0196960	VOLVO BUS	20-4	189717	0196598	BREDAMENARINIBUS	12-3
1698846	0186959	VOLVO	11-15	1897335	0506937	SCANIA	10-1
1698846	0186959	VOLVO BUS	20-4	1897667	0507771	SCANIA	10-7
1698847	0196959	VOLVO	11-15	1902996	0197929	DAF-LEYLAND DAF	3-12
1698847	0196959	VOLVO BUS	20-4	1902997	0187929	DAF-LEYLAND DAF	3-12
1699400	0296964	VOLVO	11-16	1903526	0783870	VEICOLI COMMERCIALI - LCV VEHICLE	1-30
1699400	0296964	VOLVO BUS	20-5	1903527	0793870	VEICOLI COMMERCIALI - LCV VEHICLE	1-30
1699401	0286964	VOLVO	11-16	1903652	0280515	IVECO TRUCK	5-16
1699401	0286964	VOLVO BUS	20-4				
1700000	0507949	DAF-LEYLAND DAF	3-1				
1700912	0507928	DAF-LEYLAND DAF	3-5				
1703472	0187929	DAF-LEYLAND DAF	3-12				
1703473	0197929	DAF-LEYLAND DAF	3-12				
1705907	0187929	DAF-LEYLAND DAF	3-12				

Cross Reference Guide

RIF. ORIG O.E. NUMBER	RIF. OCAP REF. OCAP	MARCA	PAG.	RIF. ORIG O.E. NUMBER	RIF. OCAP REF. OCAP	MARCA	PAG.
1903652	0280515	VEICOLI COMMERCIALI - LCV VEHICLE	1-31	20994419	0507221	VOLVO	11-25
1912757	0506920	SCANIA	10-7	21041	0507470	NEOPLAN BUS	17-3
1912758	0507731	SCANIA	10-7	21106930	0509897	VOLVO	11-8
1912759	0287684	SCANIA	10-9	21106952	0509895	VOLVO	11-8
1923962	0196608	DAF-LEYLAND DAF	3-8	21119064	0509915	VOLVO	11-25
1923963	0186608	DAF-LEYLAND DAF	3-8	2113903	0506937	SCANIA	10-1
1928859	0509890	SCANIA BUS	19-7	21248088	0507221	VOLVO	11-25
1942147	0807997	SCANIA	10-12	2125090	0506937	SCANIA	10-1
1998190	0196613	VOLVO	11-14	21260274	0509916	VOLVO	11-1
2007274	0509884	SCANIA	10-8	21260286	0509896	VOLVO	11-2
2007275	0509881	SCANIA	10-7	21263821	0187686	VOLVO	11-16
2007278	0509879	SCANIA	10-8	21263821	0187686	VOLVO BUS	20-4
2007279	0509885	SCANIA	10-8	21263974	0189896	VOLVO	11-16
20303061	0507112	VOLVO	11-10	21286847	0509915	VOLVO	11-25
20375555	0509897	VOLVO	11-8	21287061	0509915	VOLVO	11-25
20375556	0509895	VOLVO	11-8	21295227	0807762	VOLVO	11-20
20382314	0809909	VOLVO	11-19	21299034	0509894	VOLVO	11-3
20392649	0807762	VOLVO	11-20	21308024	0507686	VOLVO BUS	20-2
20393061	0507112	VOLVO	11-10	213123268	0507253	RENAULT V.I.	9-5
20393063	0507120	VOLVO	11-8	213123269	0507253	RENAULT V.I.	9-5
20393069	0507111	VOLVO	11-7	21406952	0509895	VOLVO	11-8
20393079	0509891	VOLVO	11-9	2161883	0506937	SCANIA	10-1
20393083	0507702	VOLVO	11-4	22159733	0509897	VOLVO	11-8
20393091	0509898	VOLVO	11-13	22163637	0509911	VOLVO	11-3
20393097	0509896	VOLVO	11-2	243664	0187230	SCANIA	10-20
20393186	0509897	VOLVO	11-8	24425660	0509898	VOLVO	11-13
20393187	0509895	VOLVO	11-8	2443499	0506881	IVECO TRUCK	5-3
20399543	0509894	VOLVO	11-3	2444423	0506860	IVECO TRUCK	5-8
20400907	0507715	VOLVO	11-12	2454629	0506851	IVECO TRUCK	5-5
20400909	0507116	VOLVO	11-12	2458534	0506814	IVECO TRUCK	5-7
20400941	0507115	VOLVO	11-10	24601005	0507977	MERCEDES	7-24
20400942	0507802	VOLVO	11-10	2460515	0187157	IVECO TRUCK	5-34
20400944	0507118	VOLVO	11-10	2461519	0506854	IVECO TRUCK	5-7
20442113	0509898	VOLVO	11-13	2463583	0187156	IVECO TRUCK	5-35
20443061	0807918	VOLVO	11-17	2475843	0506794	IVECO TRUCK	5-3
20443062	0507221	VOLVO	11-25	2476050	0506788	IVECO TRUCK	5-3
20443066	0507221	VOLVO	11-25	2476066	0506755	IVECO TRUCK	5-4
20444418	0807918	VOLVO	11-17	2478910	0506818	IVECO TRUCK	5-2
20453027	0509893	VOLVO	11-5	2506671	0506795	IVECO BUS	14-2
20477805	0807691	VOLVO	11-17	251407187A	0400889	VEICOLI COMMERCIALI - LCV VEHICLE	1-93
20490120	0507686	VOLVO BUS	20-2	251407187C	0404001	VEICOLI COMMERCIALI - LCV VEHICLE	1-93
20497798	0507224	VOLVO	11-1	251407361	0400888	VEICOLI COMMERCIALI - LCV VEHICLE	1-93
20497800	0507222	VOLVO	11-5	251411041C	1214127	VEICOLI COMMERCIALI - LCV VEHICLE	1-93
20502944	0809909	VOLVO	11-19	251419803	0501501	VEICOLI COMMERCIALI - LCV VEHICLE	1-93
20513951	0509898	VOLVO	11-13	251419803A	0501501	VEICOLI COMMERCIALI - LCV VEHICLE	1-93
20547286	0907919	VOLVO	11-24	251419811	0280886	VEICOLI COMMERCIALI - LCV VEHICLE	1-93
20581086	0509914	VOLVO	11-2	251419831A	1211142	VEICOLI COMMERCIALI - LCV VEHICLE	1-93
20581089	0189914	VOLVO	11-16	2519077	0506858	IVECO TRUCK	5-6
20589061	0807914	VOLVO	11-21	270911	0927456	VOLVO	11-27
206137	0927398	DAF-LEYLAND DAF	3-23	270911	0927456	VOLVO BUS	20-9
20710008	0199914	VOLVO	11-16	270912	0927458	VOLVO	11-27
20713859	0509910	RENAULT V.I.	9-2	270912	0927458	VOLVO BUS	20-9
20741710	0907913	VOLVO	11-24				
20745924	0507686	VOLVO BUS	20-2				
20751021	0927221	VOLVO	11-27				
20829503	0807762	VOLVO	11-20				
20830369	0507975	VOLVO	11-1				



Cross Reference Guide

RIF. ORIG O.E. NUMBER	RIF. OCAP REF. OCAP	MARCA	PAG.	RIF. ORIG O.E. NUMBER	RIF. OCAP REF. OCAP	MARCA	PAG.
271141	0927456	VOLVO	11-27	2980884	0907258	DAF-LEYLAND DAF	3-14
271141	0927456	VOLVO BUS	20-9	2980884	0907258	IVECO TRUCK	5-22
271142	0927458	VOLVO	11-27	2981461	0187278	IVECO TRUCK	5-18
271142	0927458	VOLVO BUS	20-9	2983125	0907262	IVECO TRUCK	5-23
271187	0907528	VOLVO	11-17	2984061	0196598	IVECO TRUCK	5-18
271188	0907257	VOLVO	11-23	2984511	0196424	IVECO TRUCK	5-18
273373	0907359	VOLVO	11-17	2992592	0902749	VEICOLI COMMERCIALI - LCV VEHICLE	1-34
273375	0907534	VOLVO	11-23	2992593	0602749	VEICOLI COMMERCIALI - LCV VEHICLE	1-34
273706	0907533	VOLVO	11-21				
274019	0907359	VOLVO	11-17	2D0407021	0791505	VEICOLI COMMERCIALI - LCV VEHICLE	1-39
274056	0907529	VOLVO	11-21				
274068	0907304	VOLVO	11-18	2D0407021B	0791505	VEICOLI COMMERCIALI - LCV VEHICLE	1-39
274069	0907545	VOLVO	11-18				
275988	0907405	VOLVO	11-23	2D0407022	0781505	VEICOLI COMMERCIALI - LCV VEHICLE	1-38
276015	0927456	VOLVO	11-27				
276015	0927456	VOLVO BUS	20-9	2D0407022B	0781505	VEICOLI COMMERCIALI - LCV VEHICLE	1-38
276023	0927458	VOLVO	11-27	2D0407140	1215705	VEICOLI COMMERCIALI - LCV VEHICLE	1-39
276023	0927458	VOLVO BUS	20-9				
276024	0927456	VOLVO	11-27	2D0407361A	0401505	VEICOLI COMMERCIALI - LCV VEHICLE	1-38
276024	0927456	VOLVO BUS	20-9				
276030	0927456	VOLVO	11-27	2D0411051	0591514	VEICOLI COMMERCIALI - LCV VEHICLE	1-39
276030	0927456	VOLVO BUS	20-9				
276031	0927458	VOLVO	11-27	2D0411052	0581514	VEICOLI COMMERCIALI - LCV VEHICLE	1-39
276031	0927458	VOLVO BUS	20-9				
276031	0927458	VOLVO BUS	20-9	2D0422803	0501503	VEICOLI COMMERCIALI - LCV VEHICLE	1-38
276032	0927456	VOLVO	11-27				
276032	0927456	VOLVO BUS	20-9	2D0422811	0281503	VEICOLI COMMERCIALI - LCV VEHICLE	1-38
276191	0907683	VOLVO	11-18				
276192	0907529	VOLVO	11-21	2D0422831	1211400	VEICOLI COMMERCIALI - LCV VEHICLE	1-38
276192	0907686	MAN	6-21				
276192	0907686	VOLVO	11-18	2D0498831	0901504	VEICOLI COMMERCIALI - LCV VEHICLE	1-38
278663	0506889	SCANIA	10-6				
278664	0506889	SCANIA	10-6	2D0511329	0104151	VEICOLI COMMERCIALI - LCV VEHICLE	1-39
278665	0506816	SCANIA	10-6				
278666	0506816	SCANIA	10-6	2E0407152M	0782742	VEICOLI COMMERCIALI - LCV VEHICLE	1-40
283766	0507777	SCANIA	10-2				
283768	0507776	SCANIA	10-1	300308	0507188	SCANIA	10-3
283783	0196598	SCANIA	10-9	3004600205	0507140	MERCEDES BUS	16-4
283783	0196598	SCANIA BUS	19-3	3004600305	0507139	NEOPLAN BUS	17-4
283784	0186598	SCANIA	10-9	3004600305	0507140	MERCEDES BUS	16-4
283784	0186598	SCANIA BUS	19-3	3004600405	0507138	MERCEDES BUS	16-6
288281	0507934	DAF-LEYLAND DAF	3-2	3004600405	0507138	NEOPLAN BUS	17-4
291395	0506846	SCANIA	10-4	3004600505	0507138	MERCEDES BUS	16-6
291396	0506846	SCANIA	10-4	3004600505	0507138	NEOPLAN BUS	17-4
291398	0506914	SCANIA	10-4	3004600605	0507139	MERCEDES BUS	16-5
296110	0807507	DAF-LEYLAND DAF	3-16	3004600605	0507139	NEOPLAN BUS	17-4
2966252	0186598	IVECO BUS	14-4	3004600705	0507139	MERCEDES BUS	16-5
2966321	0186613	IVECO TRUCK	5-17	3004600705	0507139	NEOPLAN BUS	17-4
2966635	0186613	IVECO TRUCK	5-17	301369	0506939	SCANIA	10-2
2966688	0186424	IVECO TRUCK	5-18	3014600005	0507140	MERCEDES BUS	16-4
2968454	0907257	IVECO TRUCK	5-25	3014600105	0507140	MERCEDES BUS	16-4
2969507	0196613	IVECO TRUCK	5-17	3014600505	0507138	NEOPLAN BUS	17-4
2969808	0186598	IVECO BUS	14-4	301639	0506939	SCANIA	10-2
2969808	0186598	IVECO TRUCK	5-18	3023300035	0196424	MERCEDES	7-27
2969844	0907259	IVECO BUS	14-6	3023300035	0196424	MERCEDES BUS	16-9
2969844	0907259	IVECO TRUCK	5-21	3023300035	0196424	NEOPLAN BUS	17-6
2980129	0196424	IVECO TRUCK	5-18	3023300135	0196424	MERCEDES	7-27
2980323	0186424	IVECO TRUCK	5-18	3023300135	0196424	MERCEDES BUS	16-9
2980875	0187146	IVECO TRUCK	5-19	3023300135	0196424	NEOPLAN BUS	17-6
				3023300235	0196424	MERCEDES	7-27
				3023300235	0196424	MERCEDES BUS	16-9

**Cross Reference Guide**

<b>RIF. ORIG O.E. NUMBER</b>	<b>RIF. OCAP REF. OCAP</b>	<b>MARCA</b>	<b>PAG.</b>	<b>RIF. ORIG O.E. NUMBER</b>	<b>RIF. OCAP REF. OCAP</b>	<b>MARCA</b>	<b>PAG.</b>
3023300235	0196424	NEOPLAN BUS	17-6	3093302003	0507652	MERCEDES	7-24
3023300303	0507654	MERCEDES BUS	16-3	3093302003	0507652	MERCEDES BUS	16-7
3023300335	0196424	MERCEDES	7-27	3093302103	0507652	MERCEDES	7-24
3023300335	0196424	MERCEDES BUS	16-9	3093302103	0507652	MERCEDES BUS	16-7
3023300335	0196424	NEOPLAN BUS	17-6	309331303	0507652	MERCEDES	7-24
3023300603	0507654	MERCEDES BUS	16-3	3093469	0907297	VOLVO	11-23
3023301803	0507654	MERCEDES BUS	16-3	3093469	0907297	VOLVO BUS	20-6
3024600305	0507667	MERCEDES	7-22	3093544	0907913	VOLVO	11-24
3024600505	0507661	MERCEDES	7-10	3093630	0907763	RENAULT V.I.	9-20
3024600605	0507661	MERCEDES	7-10	3093631	0907763	RENAULT V.I.	9-20
3024603505	0507667	MERCEDES	7-22	3093631	0907763	VOLVO	11-20
3024603605	0507667	MERCEDES	7-22	3093647	0187686	VOLVO	11-16
3024603905	0507661	MERCEDES	7-10	3093647	0187686	VOLVO BUS	20-4
3024604005	0507661	MERCEDES	7-10	3094600305	0500730	MERCEDES	7-8
3024633429	0186424	MERCEDES	7-26	3094600305	0500730	VEICOLI COMMERCIALI - LCV VEHICLE	1-43
3039647	0509899	VOLVO BUS	20-2	3094602905	0500730	MERCEDES	7-8
305317	0507242	SCANIA	10-20	3094602905	0500730	VEICOLI COMMERCIALI - LCV VEHICLE	1-43
305319	0297229	SCANIA	10-20	3094603005	0500730	MERCEDES	7-8
305320	0287229	SCANIA	10-20	3094603005	0500730	VEICOLI COMMERCIALI - LCV VEHICLE	1-43
3053300403	0507619	MERCEDES BUS	16-3	3094603105	0500730	MERCEDES	7-8
3053300803	0507619	MERCEDES BUS	16-3	3094603105	0500730	VEICOLI COMMERCIALI - LCV VEHICLE	1-43
3053301003	0507619	MERCEDES BUS	16-3	3094603205	0500730	MERCEDES	7-8
3054600305	0507139	MERCEDES BUS	16-5	3094603205	0500730	VEICOLI COMMERCIALI - LCV VEHICLE	1-43
3054600305	0507139	NEOPLAN BUS	17-4	3096213	0186424	IVECO TRUCK	5-18
3054600605	0507142	MERCEDES BUS	16-7	3097228	0189896	VOLVO	11-16
306913	0506913	SCANIA	10-5	3098294	0509892	VOLVO BUS	20-2
306981	0506918	SCANIA	10-7	3099128	0289923	DAF-LEYLAND DAF	3-8
307443	0407232	SCANIA	10-20	3099128	0289923	IVECO TRUCK	5-16
3090015	0907770	VOLVO	11-17	3099128	0289923	MAN	6-11
3090266	0927458	VOLVO	11-27	3099128	0289923	VOLVO	11-14
3090266	0927458	VOLVO BUS	20-9	3099230	0507975	VOLVO	11-1
3090267	0927456	VOLVO	11-27	3099529	0189896	VOLVO	11-16
3090267	0927456	VOLVO BUS	20-9	3103300635	0187342	MERCEDES	7-26
3090291	0289923	DAF-LEYLAND DAF	3-8	3103301035	0187342	MERCEDES	7-26
3090291	0289923	IVECO TRUCK	5-16	3103301219	0927416	MERCEDES	7-52
3090291	0289923	MAN	6-11	3103301235	0187342	MERCEDES	7-26
3090291	0289923	VOLVO	11-14	3103301335	0180730	MERCEDES	7-25
3090452	0909909	VOLVO	11-19	3103301335	0180730	MERCEDES BUS	16-8
3090472	0186946	VOLVO	11-15	3103301335	0180730	VEICOLI COMMERCIALI - LCV VEHICLE	1-43
3090712	0907762	RENAULT V.I.	9-20	310977	0507725	SCANIA	10-2
3090712	0907762	VOLVO	11-20	3109774	0507725	SCANIA	10-2
3090727	0186946	VOLVO	11-15	310979	0296759	SCANIA	10-10
3090728	0196946	VOLVO	11-15	310980	0286759	SCANIA	10-10
3092189	0189896	VOLVO	11-16	3110001	0196946	VOLVO	11-15
3092452	0909909	VOLVO	11-19	3110002	0186946	VOLVO	11-15
3092471	0196959	VOLVO	11-15	3110011	0196959	VOLVO	11-15
3093301203	0507652	MERCEDES	7-24	3112050	0507224	VOLVO	11-1
3093301203	0507652	MERCEDES BUS	16-7	3112050	0507224	VOLVO BUS	20-1
3093301403	0507652	MERCEDES	7-24	3112122	0507222	VOLVO	11-5
3093301403	0507652	MERCEDES BUS	16-7	3112122	0507222	VOLVO BUS	20-2
3093301603	0507652	MERCEDES	7-24	3112273	0507223	VOLVO BUS	20-2
3093301603	0507652	MERCEDES BUS	16-7	3112282	0509906	VOLVO BUS	20-7
3093301703	0507652	MERCEDES	7-24	3116050	0509901	VOLVO BUS	20-3
3093301703	0507652	MERCEDES BUS	16-7	311846	0507725	SCANIA	10-2
3093301803	0507652	MERCEDES	7-24				
3093301803	0507652	MERCEDES BUS	16-7				
3093301903	0507652	MERCEDES	7-24				
3093301903	0507652	MERCEDES BUS	16-7				

Cross Reference Guide

RIF. ORIG O.E. NUMBER	RIF. OCAP REF. OCAP	MARCA	PAG.	RIF. ORIG O.E. NUMBER	RIF. OCAP REF. OCAP	MARCA	PAG.
3124480	0507116	VOLVO	11-12	3464600005	0507665	MERCEDES	7-12
31244809	0507116	VOLVO	11-12	3464600105	0507665	MERCEDES	7-12
3124594	0507116	VOLVO	11-12	3464605005	0507665	MERCEDES	7-12
3124962	0507121	VOLVO	11-10	3465860033	0927437	MERCEDES	7-53
3127737	0507118	VOLVO	11-10	3465860133	0927410	MERCEDES	7-52
3133173	0907406	VOLVO	11-19	350270	0187230	SCANIA	10-20
3134600005	0507606	MERCEDES BUS	16-4	3503307035	0186424	MERCEDES	7-26
3134600105	0507606	MERCEDES BUS	16-4	3503307135	0196424	MERCEDES	7-27
3163300203	0507786	MERCEDES	7-1	3503307203	0507658	MERCEDES	7-4
3163300203	0507786	MERCEDES BUS	16-2	352095	0391141	VEICOLI COMMERCIALI - LCV VEHICLE	1-2
3163300503	0507786	MERCEDES	7-1	352096	0391140	VEICOLI COMMERCIALI - LCV VEHICLE	1-3
3163300503	0507786	MERCEDES BUS	16-2	3520N3	0391446	VEICOLI COMMERCIALI - LCV VEHICLE	1-2
3163300603	0507786	MERCEDES BUS	16-2	3520N4	0391451	VEICOLI COMMERCIALI - LCV VEHICLE	1-3
3163300703	0507786	MERCEDES	7-1	3520N4	0391451	VEICOLI COMMERCIALI - LCV VEHICLE	1-3
3163300703	0507786	MERCEDES BUS	16-2	3520R8	0392734	VEICOLI COMMERCIALI - LCV VEHICLE	1-9
3164600605	0507625	MERCEDES	7-9	3520S0	0392638	VEICOLI COMMERCIALI - LCV VEHICLE	1-5
3164600705	0507625	MERCEDES	7-9	3520S1	0392639	VEICOLI COMMERCIALI - LCV VEHICLE	1-6
3164600805	0507625	MERCEDES	7-9	3520S1	0392639	VEICOLI COMMERCIALI - LCV VEHICLE	1-6
3164600905	0507625	MERCEDES	7-9	3520.95	0391141	VEICOLI COMMERCIALI - LCV VEHICLE	1-2
3164800806	0507625	MERCEDES	7-9	3520.96	0391140	VEICOLI COMMERCIALI - LCV VEHICLE	1-3
3172829	0809907	VOLVO	11-21	3520.N3	0391446	VEICOLI COMMERCIALI - LCV VEHICLE	1-2
3173500606	0807418	MERCEDES BUS	16-12	3520.N4	0391451	VEICOLI COMMERCIALI - LCV VEHICLE	1-3
3173500706	0807417	MERCEDES BUS	16-14	352165	0381141	VEICOLI COMMERCIALI - LCV VEHICLE	1-1
3173613	0509905	VOLVO	11-25	352166	0381140	VEICOLI COMMERCIALI - LCV VEHICLE	1-2
319359	0507725	SCANIA	10-2	3521J3	0381446	VEICOLI COMMERCIALI - LCV VEHICLE	1-2
3223301011	0807419	MERCEDES BUS	16-15	3521J4	0381451	VEICOLI COMMERCIALI - LCV VEHICLE	1-3
325537	0196758	SCANIA	10-9	3521N9	0382734	VEICOLI COMMERCIALI - LCV VEHICLE	1-9
325615	0187838	SCANIA	10-9	3521P1	0382638	VEICOLI COMMERCIALI - LCV VEHICLE	1-5
3265974	0280037	VEICOLI COMMERCIALI - LCV VEHICLE	1-7	3521P2	0382639	VEICOLI COMMERCIALI - LCV VEHICLE	1-6
3273300103	0507620	MERCEDES	7-5	3521.65	0381141	VEICOLI COMMERCIALI - LCV VEHICLE	1-1
3273300303	0507620	MERCEDES	7-5	3521.66	0381140	VEICOLI COMMERCIALI - LCV VEHICLE	1-2
3273300403	0507620	MERCEDES	7-5	3521.J3	0381446	VEICOLI COMMERCIALI - LCV VEHICLE	1-2
3273300803	0507620	MERCEDES	7-5	3521.J4	0381451	VEICOLI COMMERCIALI - LCV VEHICLE	1-3
3354600005	0507665	MERCEDES	7-12	3523301603	0507655	MERCEDES	7-4
3433201032	0807602	MERCEDES	7-35	3523301903	0507655	MERCEDES	7-4
3433201632	0807601	MERCEDES	7-35	3523302003	0507655	MERCEDES	7-4
3433201732	0807601	MERCEDES	7-35	3523302303	0507655	MERCEDES	7-4
3433201832	0807601	MERCEDES	7-35	3523302403	0507655	MERCEDES	7-4
3433300103	0507647	MERCEDES	7-2	3523500306	0807638	MERCEDES	7-34
3433300303	0507647	MERCEDES	7-2	3524602105	0507662	MERCEDES	7-10
3433300403	0507647	MERCEDES	7-2	3524602305	0507621	MERCEDES	7-10
3434600405	0507664	MERCEDES	7-12	3524602405	0507621	MERCEDES	7-10
3434600805	0507664	MERCEDES	7-12	3524602905	0507662	MERCEDES	7-10
3434601005	0507664	MERCEDES	7-12	3524603005	0507663	MERCEDES	7-10
3434601205	0507664	MERCEDES	7-12	3524603705	0507607	MERCEDES	7-10
3434601405	0507664	MERCEDES	7-12				
3434601505	0507664	MERCEDES	7-12				
3435788	0181785	IVECO TRUCK	5-38				
3435860032	0907601	MERCEDES	7-34				
345124	0506888	SCANIA	10-6				
34602905	0507977	MERCEDES	7-24				
3463300019	0927437	MERCEDES	7-53				
3463300119	0927438	MERCEDES	7-53				
3463303903	0507437	MERCEDES	7-3				
3463304903	0507437	MERCEDES	7-3				
3463320106	0927409	MERCEDES	7-52				

Cross Reference Guide

RIF. ORIG O.E. NUMBER	RIF. OCAP REF. OCAP	MARCA	PAG.	RIF. ORIG O.E. NUMBER	RIF. OCAP REF. OCAP	MARCA	PAG.
3524604605	0507662	MERCEDES	7-10	364032	0401137	VEICOLI COMMERCIALI - LCV VEHICLE	1-1
3524604705	0507663	MERCEDES	7-10				
3524605505	0507662	MERCEDES	7-10	364033	0401138	VEICOLI COMMERCIALI - LCV VEHICLE	1-2
3524605805	0507663	MERCEDES	7-10				
3524606605	0507607	MERCEDES	7-10	364054	0401451	VEICOLI COMMERCIALI - LCV VEHICLE	1-3
3524606705	0507621	MERCEDES	7-10				
3524606805	0507621	MERCEDES	7-10	364055	0401446	IVECO TRUCK	5-34
3524607105	0507607	MERCEDES	7-10	364055	0401446	VEICOLI COMMERCIALI - LCV VEHICLE	1-2
352635	0506889	SCANIA	10-6				
352637	0506829	SCANIA	10-6	364067	0402638	VEICOLI COMMERCIALI - LCV VEHICLE	1-5
352645	0196758	SCANIA	10-9	3640.32	0401137	VEICOLI COMMERCIALI - LCV VEHICLE	1-1
3553300319	0927432	MERCEDES	7-53				
3553300319	0927432	MERCEDES BUS	16-21	3640.33	0401138	VEICOLI COMMERCIALI - LCV VEHICLE	1-2
3555860033	0927432	MERCEDES	7-53	3640.54	0401451	VEICOLI COMMERCIALI - LCV VEHICLE	1-3
3555860033	0927432	MERCEDES BUS	16-21				
3563300003	0507600	MERCEDES BUS	16-2	3640.55	0401446	IVECO TRUCK	5-34
3563300103	0507144	MERCEDES BUS	16-4	3640.55	0401446	VEICOLI COMMERCIALI - LCV VEHICLE	1-2
3563300211	0807414	MERCEDES BUS	16-15				
3563331304	0807672	MERCEDES BUS	16-13	3643307411	0807417	MERCEDES BUS	16-14
3564600205	0507438	MERCEDES BUS	16-6	36466106007	0507952	MAN BUS	15-5
3573300203	0507616	MERCEDES BUS	16-3	36466106007	0507952	NEOPLAN BUS	17-4
3573300403	0507616	MERCEDES BUS	16-3	36466106012	0507410	MAN BUS	15-5
3573300503	0507616	MERCEDES BUS	16-3	36466106033	0507952	MAN BUS	15-5
3573300603	0507742	MERCEDES BUS	16-3	36466106033	0507952	NEOPLAN BUS	17-4
3573300703	0507742	MERCEDES BUS	16-3	36466106040	0507410	MAN BUS	15-5
3573300803	0507644	MERCEDES BUS	16-3	366757	0196959	VOLVO	11-15
3573300903	0507644	MERCEDES BUS	16-3	370875	0506919	SCANIA	10-5
3573301103	0507619	MERCEDES BUS	16-3	371448	0507243	SCANIA	10-20
3573301403	0507644	MERCEDES BUS	16-3	371451	0297229	SCANIA	10-20
3573301503	0507619	MERCEDES BUS	16-3	371452	0287229	SCANIA	10-20
3573301603	0507616	MERCEDES BUS	16-3	371453	0507242	SCANIA	10-20
3573303111	0807419	MERCEDES BUS	16-15				
3573303411	0807418	MERCEDES BUS	16-12	3734600305	0507667	MERCEDES	7-22
3573330101	0807531	MERCEDES BUS	16-16	3734600505	0507143	MERCEDES BUS	16-6
3573330205	0807822	MERCEDES BUS	16-15	3734600505	0507667	MERCEDES	7-22
3573330405	0807594	MERCEDES BUS	16-12	3734600605	0507661	MERCEDES	7-10
3573330605	0807542	MERCEDES BUS	16-15	3734600705	0507143	MERCEDES BUS	16-6
3573330905	0807542	MERCEDES BUS	16-15	3734600705	0507667	MERCEDES	7-22
3573500306	0807882	MERCEDES BUS	16-12	3734600905	0507661	MERCEDES	7-10
3574601005	0507141	MERCEDES BUS	16-6	3734601005	0507143	MERCEDES BUS	16-6
3574601105	0507141	MERCEDES BUS	16-6	3736028	0503870	VEICOLI COMMERCIALI - LCV VEHICLE	1-28
3574601205	0507142	MERCEDES BUS	16-7				
3574601305	0507142	MERCEDES BUS	16-7	3753500105	0807984	MERCEDES	7-39
3574601405	0507645	MERCEDES BUS	16-6	3753500205	0807774	MERCEDES	7-40
3574601505	0507645	MERCEDES BUS	16-6	3753500505	0807599	MERCEDES	7-38
3574602005	0507685	MERCEDES BUS	16-7	3754600005	0507887	MERCEDES	7-20
3574602205	0507438	MERCEDES BUS	16-6	3754600405	0507789	MERCEDES	7-21
3574602305	0507685	MERCEDES BUS	16-7	3754601505	0507911	MERCEDES	7-23
3574602405	0507422	MERCEDES BUS	16-6	3754601605	0507587	MERCEDES	7-11
3574602505	0507426	MERCEDES BUS	16-5	3754601705	0507973	MERCEDES	7-19
3574603105	0507422	MERCEDES BUS	16-6	3812A4	0600918	VEICOLI COMMERCIALI - LCV VEHICLE	1-7
3574603205	0507426	MERCEDES BUS	16-5				
3574603505	0507431	MERCEDES BUS	16-7	3812F0	0602733	VEICOLI COMMERCIALI - LCV VEHICLE	1-9
3583300103	0507605	MERCEDES	7-5				
3583300503	0507605	MERCEDES	7-5	3813300303	0507605	MERCEDES	7-5
3583300703	0507620	MERCEDES	7-5	3813300503	0507605	MERCEDES	7-5
3593300011	0807417	MERCEDES BUS	16-14	3813300603	0507605	MERCEDES	7-5
				3813300703	0507605	MERCEDES	7-5
				381339	0506869	SCANIA	10-6
				3813500206	0807556	MERCEDES	7-36
				3813500306	0807603	MERCEDES	7-37



Cross Reference Guide

RIF. ORIG O.E. NUMBER	RIF. OCAP REF. OCAP	MARCA	PAG.	RIF. ORIG O.E. NUMBER	RIF. OCAP REF. OCAP	MARCA	PAG.
3813500606	0807585	MERCEDES	7-30	3874605005	0506575	MERCEDES	7-18
381770	0282637	VEICOLI COMMERCIALI - LCV VEHICLE	1-5	388941	0507733	SCANIA	10-8
381773	0282733	VEICOLI COMMERCIALI - LCV VEHICLE	1-9	388942	0507732	SCANIA	10-8
381777	0292637	VEICOLI COMMERCIALI - LCV VEHICLE	1-5	3889425	0507732	SCANIA	10-8
3823300403	0507435	MERCEDES BUS	16-3	388943	0507780	SCANIA	10-1
382613	0187682	VOLVO	11-26	3893200732	0807826	MERCEDES	7-32
382702	0507727	SCANIA	10-3	3893200832	0807827	MERCEDES	7-38
382745	0187241	VOLVO	11-26	3895860033	0927436	MERCEDES	7-53
382774	0507188	SCANIA	10-3	3895860033	0927436	MERCEDES BUS	16-21
382780	0507727	SCANIA	10-3	389867	0507728	SCANIA	10-4
3833500006	0807556	MERCEDES	7-36	389870	0507924	BREDAMENARINIBUS	12-1
3833500105	0807218	MERCEDES	7-41	389870	0507924	DAF-LEYLAND DAF	3-3
3834600605	0506963	MERCEDES	7-19	389870	0507924	SCANIA	10-4
3834600705	0507696	MERCEDES	7-19	390784	0506913	SCANIA	10-5
3834600805	0506584	MERCEDES	7-19	3913300019	0927436	MERCEDES	7-53
3834601405	0506963	MERCEDES	7-19	3913300019	0927436	MERCEDES BUS	16-21
3834601605	0506584	MERCEDES	7-19	3913300603	0507610	MERCEDES	7-1
3834602108	0507696	MERCEDES	7-19	3913300803	0507610	MERCEDES	7-1
3834602305	0506963	MERCEDES	7-19	3913301003	0507610	MERCEDES	7-1
3834602405	0506584	MERCEDES	7-19	3913301203	0507610	MERCEDES	7-1
3834604405	0506963	MERCEDES	7-19	3914600905	0507697	MERCEDES	7-24
3834604505	0506584	MERCEDES	7-19	3914600905	0507697	MERCEDES	7-24
3834606605	0507696	MERCEDES	7-19	3914601705	0507697	MERCEDES	7-24
3834606705	0507696	MERCEDES	7-19	3914601805	0507697	MERCEDES	7-24
3853300203	0507793	MERCEDES	7-5	3915860033	0927436	MERCEDES	7-53
3853300503	0507657	MERCEDES	7-4	3915860033	0927436	MERCEDES BUS	16-21
3853300603	0507657	MERCEDES	7-4	3933200132	0807586	MERCEDES	7-34
3853300803	0507793	MERCEDES	7-5	3933200232	0807828	MERCEDES	7-42
3853301103	0507657	MERCEDES	7-4	3933200332	0807825	MERCEDES	7-30
3853301303	0507218	MERCEDES	7-5	3933200632	0506575	MERCEDES	7-18
3853301403	0507657	MERCEDES	7-4	3933300003	0507658	MERCEDES	7-4
3853301403	0507657	MERCEDES BUS	16-2	3933300203	0507658	MERCEDES	7-4
3853301503	0507657	MERCEDES	7-4	3933300303	0507658	MERCEDES	7-4
3853301603	0507793	MERCEDES	7-5	3933300403	0507658	MERCEDES	7-4
3853301803	0507793	MERCEDES	7-5	3933505205	0807218	MERCEDES	7-41
3853302103	0507218	MERCEDES	7-5	3933505305	0807218	MERCEDES	7-41
3853302203	0507218	MERCEDES	7-5	3933505405	0807218	MERCEDES	7-41
3853302403	0507218	MERCEDES	7-5	3933505505	0807218	MERCEDES	7-41
3853500006	0807642	MERCEDES	7-30	395009	0196598	SCANIA	10-9
3853500106	0807608	MERCEDES	7-37	395009	0196598	SCANIA BUS	19-3
3853500206	0807603	MERCEDES	7-37	395010	0186598	SCANIA	10-9
386930	0187228	DAF-LEYLAND DAF	3-22	395010	0186598	SCANIA BUS	19-3
3874600005	0506579	MERCEDES	7-18	3951306	0807770	VOLVO	11-17
3874600405	0506575	MERCEDES	7-18	3953200132	0807606	MERCEDES	7-31
3874600605	0506580	MERCEDES	7-15	3953200206	0807612	MERCEDES	7-33
3874600705	0506962	MERCEDES	7-15	3953200332	0807608	MERCEDES	7-37
3874601405	0506962	MERCEDES	7-15	3953201432	0807610	MERCEDES	7-44
3874601505	0507671	MERCEDES	7-15	3953201532	0807607	MERCEDES	7-42
3874603205	0506962	MERCEDES	7-15	395346	0507778	SCANIA	10-1
3874603305	0506962	MERCEDES	7-15	395347	0507778	SCANIA	10-1
3874603505	0507671	MERCEDES	7-15	395348	0507779	SCANIA	10-1
3874603605	0507671	MERCEDES	7-15	395350	0506939	SCANIA	10-2
3874604405	0506580	MERCEDES	7-15	3953500006	0807611	MERCEDES	7-31
3874604505	0506580	MERCEDES	7-15	3953500206	0807643	MERCEDES	7-33
3874604805	0506579	MERCEDES	7-18	3953500606	0807614	MERCEDES	7-37
3874604905	0506579	MERCEDES	7-18	3953500706	0807617	MERCEDES	7-33
				3953500806	0807600	MERCEDES	7-37
				3953501006	0807829	MERCEDES	7-43
				3953501106	0807831	MERCEDES	7-44

Cross Reference Guide

RIF. ORIG O.E. NUMBER	RIF. OCAP REF. OCAP	MARCA	PAG.	RIF. ORIG O.E. NUMBER	RIF. OCAP REF. OCAP	MARCA	PAG.
3953501206	0807831	MERCEDES	7-44	4054600605	0507617	MERCEDES	7-11
3953501306	0807618	MERCEDES	7-43	405909	0280037	VEICOLI COMMERCIALI - LCV VEHICLE	1-7
395432	0506939	SCANIA	10-2				
3962343	0507124	VOLVO	11-2	4059921	0993868	VEICOLI COMMERCIALI - LCV VEHICLE	1-26
3962768	0507703	VOLVO	11-13				
3985570	0509896	VOLVO	11-2	4059922	0983868	VEICOLI COMMERCIALI - LCV VEHICLE	1-26
3986443	0807691	VOLVO	11-17	4059923	0693868	VEICOLI COMMERCIALI - LCV VEHICLE	1-26
3986450	0507124	VOLVO	11-2				
3986452	0509897	VOLVO	11-8	4059924	0683868	VEICOLI COMMERCIALI - LCV VEHICLE	1-26
3986454	0507124	VOLVO	11-2				
3987354	0509905	VOLVO	11-25	4064600105	0507976	MERCEDES	7-23
3988695	0507112	VOLVO	11-10	406635	0900449	VEICOLI COMMERCIALI - LCV VEHICLE	1-1
3988697	0507112	VOLVO	11-10				
3988701	0507120	VOLVO	11-8	406683	0902733	VEICOLI COMMERCIALI - LCV VEHICLE	1-9
3988704	0507111	VOLVO	11-7	406683 *	1211477	VEICOLI COMMERCIALI - LCV VEHICLE	1-9
3988708	0509891	VOLVO	11-9				
3988710	0509891	VOLVO	11-9	406686	0902637	VEICOLI COMMERCIALI - LCV VEHICLE	1-5
3988711	0507124	VOLVO	11-2				
3988965	0186946	VOLVO	11-15	409639	0807758	SCANIA	10-13
3988968	0196946	VOLVO	11-15	41002118	0281786	IVECO TRUCK	5-37
4000SF *	0602637	VEICOLI COMMERCIALI - LCV VEHICLE	1-5	41002119	0291786	IVECO TRUCK	5-37
4000SG *	0602637	VEICOLI COMMERCIALI - LCV VEHICLE	1-5	41002770	0807211	IVECO TRUCK	5-28
				41003268	0807292	IVECO TRUCK	5-22
400622	0900489	VEICOLI COMMERCIALI - LCV VEHICLE	1-1	41005309	0507288	IVECO TRUCK	5-4
				41005450	0506932	IVECO TRUCK	5-4
400624	0601139	VEICOLI COMMERCIALI - LCV VEHICLE	1-1	41005451	0506932	IVECO TRUCK	5-4
				41005456	0506927	IVECO TRUCK	5-5
40160-00QAB	0401522	VEICOLI COMMERCIALI - LCV VEHICLE	1-55	41005460	0507288	IVECO TRUCK	5-4
				41005463	0506931	IVECO BUS	14-2
40160-00QAD	0401494	VEICOLI COMMERCIALI - LCV VEHICLE	1-55	41005463	0506931	IVECO TRUCK	5-12
				41005466	0506927	IVECO TRUCK	5-5
401608374R	0401536	VEICOLI COMMERCIALI - LCV VEHICLE	1-59	41005469	0507287	IVECO TRUCK	5-7
				41005472	0506897	IVECO TRUCK	5-8
4018036	0186603	FIAT - OM	4-5	41005475	0507293	IVECO TRUCK	5-11
4018037	0196603	FIAT - OM	4-5	41005523	0186949	IVECO TRUCK	5-37
401815	0900489	VEICOLI COMMERCIALI - LCV VEHICLE	1-1	41006093	0507293	IVECO TRUCK	5-11
				41009661	0807358	IVECO TRUCK	5-22
4018A3	0281143	VEICOLI COMMERCIALI - LCV VEHICLE	1-1	41009665	0807211	IVECO TRUCK	5-28
				41011006	0807295	IVECO TRUCK	5-23
4018A4	0601139	VEICOLI COMMERCIALI - LCV VEHICLE	1-1	41011476	0507287	IVECO TRUCK	5-7
				41016958	0506897	IVECO TRUCK	5-8
4018A5	1211310	VEICOLI COMMERCIALI - LCV VEHICLE	1-1	41016960	0507287	IVECO TRUCK	5-7
				41016961	0507287	IVECO TRUCK	5-7
4018E0	0282323	VEICOLI COMMERCIALI - LCV VEHICLE	1-1	41016964	0506927	IVECO TRUCK	5-5
				41022092	0807296	IVECO TRUCK	5-27
4018H4	0281143	VEICOLI COMMERCIALI - LCV VEHICLE	1-1	41028269	0507904	IVECO TRUCK	5-9
				41028598	0807211	IVECO TRUCK	5-28
4025438	0286665	FIAT - OM	4-7	41028599	0807296	IVECO TRUCK	5-27
4028250	0186604	FIAT - OM	4-5	41028600	0807211	IVECO TRUCK	5-28
4028250	0186604	IVECO BUS	14-4	41029665	0807211	IVECO TRUCK	5-28
4028251	0196604	FIAT - OM	4-5	41032608	0507366	IVECO TRUCK	5-2
4028251	0196604	IVECO BUS	14-4	4103300205	0507428	MERCEDES BUS	16-5
4042022	0783869	VEICOLI COMMERCIALI - LCV VEHICLE	1-27	4103300303	0507425	MERCEDES BUS	16-1
				4103300503	0507425	MERCEDES BUS	16-1
4042023	0793869	VEICOLI COMMERCIALI - LCV VEHICLE	1-27	41033237	0507366	IVECO TRUCK	5-2
				41033479	0807211	IVECO TRUCK	5-28
4042068	0503871	VEICOLI COMMERCIALI - LCV VEHICLE	1-28	41034479	0807211	IVECO TRUCK	5-28
				4103500906	0807412	MERCEDES BUS	16-12
4047091	0283867	VEICOLI COMMERCIALI - LCV VEHICLE	1-26	41035950	0807211	IVECO TRUCK	5-28
4054600005	0507617	MERCEDES	7-11				
4054600305	0507617	MERCEDES	7-11				

Cross Reference Guide

RIF. ORIG O.E. NUMBER	RIF. OCAP REF. OCAP	MARCA	PAG.	RIF. ORIG O.E. NUMBER	RIF. OCAP REF. OCAP	MARCA	PAG.
41035951	0807358	IVECO TRUCK	5-22	42037033	0507302	IVECO TRUCK	5-2
41036944	0506932	IVECO TRUCK	5-4	42037040	0506818	IVECO TRUCK	5-2
41042050	0807211	IVECO TRUCK	5-28	42037041	0506818	IVECO TRUCK	5-2
41042092	0807296	IVECO TRUCK	5-27	42037384	0506827	IVECO TRUCK	5-2
41042093	0807299	IVECO TRUCK	5-29	42037386	0506904	IVECO TRUCK	5-1
41042919	0506931	IVECO BUS	14-2	42037655	0506794	IVECO TRUCK	5-3
41042919	0506931	IVECO TRUCK	5-12	42037657	0506794	IVECO TRUCK	5-3
41203863	0281786	IVECO TRUCK	5-37	42039631	0507303	IVECO TRUCK	5-14
41203864	0291786	IVECO TRUCK	5-37	42041107	0807579	IVECO TRUCK	5-24
4120734	0403869	VEICOLI COMMERCIALI - LCV VEHICLE	1-26	42041327	0281786	IVECO TRUCK	5-37
41210795	0607191	IVECO TRUCK	5-38	42041328	0291786	IVECO TRUCK	5-37
41215165	0507370	IVECO TRUCK	5-12	42042912	0181785	IVECO TRUCK	5-38
41218021	0807363	IVECO TRUCK	5-21	42042950	0506848	IVECO TRUCK	5-10
41218482	0181785	IVECO TRUCK	5-38	42043293	0506856	IVECO TRUCK	5-7
41218621	0807372	IVECO TRUCK	5-28	42043295	0507306	IVECO TRUCK	5-6
41226580	0507370	IVECO TRUCK	5-12	42043908	0506856	IVECO TRUCK	5-7
412405	0507772	SCANIA	10-5	42043909	0507306	IVECO TRUCK	5-6
412406	0507758	SCANIA BUS	19-1	42043910	0507306	IVECO TRUCK	5-6
41272706	0807373	IVECO TRUCK	5-28	42043912	0506848	IVECO TRUCK	5-10
41272706 Z	0907774	IVECO TRUCK	5-25	42044493	0506762	IVECO BUS	14-1
41272706 Z	0907774	MAN	6-19	42064639	0506827	IVECO TRUCK	5-2
41296730	0807374	IVECO TRUCK	5-24	42065332	0807295	IVECO TRUCK	5-23
41296731	0807374	IVECO TRUCK	5-24	42071290	0287294	IVECO TRUCK	5-37
41298449	0507904	IVECO TRUCK	5-9	42072495	0607254	IVECO TRUCK	5-38
4131788	1215678	VEICOLI COMMERCIALI - LCV VEHICLE	1-27	42078019	0507310	IVECO TRUCK	5-13
4140393	0783869	VEICOLI COMMERCIALI - LCV VEHICLE	1-27	4207841	0506840	IVECO TRUCK	5-14
4140394	0793869	VEICOLI COMMERCIALI - LCV VEHICLE	1-27	42079850	0291786	IVECO TRUCK	5-37
414531	0807760	SCANIA	10-14	42079852	0291786	IVECO TRUCK	5-37
415400	0507730	SCANIA BUS	19-1	42079853	0281786	IVECO TRUCK	5-37
4164518	0783869	VEICOLI COMMERCIALI - LCV VEHICLE	1-27	42086282	0807308	IVECO TRUCK	5-29
4164522	0793869	VEICOLI COMMERCIALI - LCV VEHICLE	1-27	42086458	0506855	IVECO TRUCK	5-9
416524	0807761	SCANIA	10-11	42087841	0506840	IVECO TRUCK	5-14
416800	0807759	SCANIA	10-13	42087842	0506840	IVECO TRUCK	5-14
417290	0807738	SCANIA	10-11	42087846	0507309	IVECO TRUCK	5-13
4173761	0403869	VEICOLI COMMERCIALI - LCV VEHICLE	1-26	42087848	0507310	IVECO TRUCK	5-13
42000481	0807262	IVECO TRUCK	5-23	42088124	0507284	IVECO TRUCK	5-15
42000486	0807298	IVECO TRUCK	5-24	42100262	0506818	IVECO TRUCK	5-2
42001325	0506855	IVECO TRUCK	5-9	42100263	0506818	IVECO TRUCK	5-2
42001326	0506855	IVECO TRUCK	5-9	42100703	0506818	IVECO TRUCK	5-2
42003432	0506847	IVECO TRUCK	5-4	42102058	0506755	IVECO TRUCK	5-4
42014656	0506794	IVECO TRUCK	5-3	42102633	0507312	IVECO TRUCK	5-2
42014657	0506794	IVECO TRUCK	5-3	42105474	0287313	IVECO TRUCK	5-16
42019074	0507170	IVECO BUS	14-2	42115532	0507314	IVECO TRUCK	5-15
42023778	0507347	IVECO TRUCK	5-8	42117267	0506955	IVECO TRUCK	5-1
42023779	0507347	IVECO TRUCK	5-8	42118693	0506955	IVECO TRUCK	5-1
42026837	0506794	IVECO TRUCK	5-3	42118694	0507314	IVECO TRUCK	5-15
42026840	0506794	IVECO TRUCK	5-3	42118781	0506955	IVECO TRUCK	5-1
42026853	0506788	IVECO TRUCK	5-3	42125057	0807209	IVECO TRUCK	5-21
42034051	0807298	IVECO TRUCK	5-24	421573	0507764	SCANIA	10-7
42034054	0807262	IVECO TRUCK	5-23	42200700	0506928	IVECO TRUCK	5-8
42035418	0507301	IVECO TRUCK	5-9	42202358	0506828	IVECO TRUCK	5-10
42035419	0507301	IVECO TRUCK	5-9	42203459	0506828	IVECO TRUCK	5-10
42037032	0507302	IVECO TRUCK	5-2	42204473	0506893	IVECO TRUCK	5-10
				42204475	0506928	IVECO TRUCK	5-8
				42211146	0506928	IVECO TRUCK	5-8
				42211148	0506928	IVECO TRUCK	5-8
				4243300303	0507618	MERCEDES	7-1
				4243300503	0507618	MERCEDES	7-1

Cross Reference Guide

RIF. ORIG O.E. NUMBER	RIF. OCAP REF. OCAP	MARCA	PAG.	RIF. ORIG O.E. NUMBER	RIF. OCAP REF. OCAP	MARCA	PAG.
4244600305	0507611	MERCEDES	7-17	42551296	0797249	VEICOLI COMMERCIALI - LCV VEHICLE	1-32
42480023	0196595	IVECO TRUCK	5-17	42551297	0787249	VEICOLI COMMERCIALI - LCV VEHICLE	1-32
42480024	0186595	IVECO TRUCK	5-17	4274600005	0507611	MERCEDES	7-17
42483386	0186598	IVECO BUS	14-4	4274600105	0507611	MERCEDES	7-17
42483386	0186598	IVECO TRUCK	5-18	4274600305	0507611	MERCEDES	7-17
42483520	0186424	IVECO TRUCK	5-18	4274600405	0507611	MERCEDES	7-17
42484886	0186613	IVECO TRUCK	5-17	4322906	0280037	VEICOLI COMMERCIALI - LCV VEHICLE	1-7
42484887	0196613	IVECO TRUCK	5-17	432698	0506933	SCANIA BUS	19-2
42485638	0297229	IVECO TRUCK	5-37	4336779	0280513	IVECO TRUCK	5-16
42485639	0287319	IVECO TRUCK	5-37	4339248	1215388	VEICOLI COMMERCIALI - LCV VEHICLE	1-13
42485718	0186424	IVECO TRUCK	5-18	4372130	0783869	VEICOLI COMMERCIALI - LCV VEHICLE	1-27
42487165	0186612	IVECO TRUCK	5-17	4372131	0793869	VEICOLI COMMERCIALI - LCV VEHICLE	1-27
42487482	0187228	IVECO BUS	14-11	4373300003	0507636	MERCEDES	7-1
42488269	0186598	IVECO BUS	14-4	4373300403	0507636	MERCEDES	7-1
42488269	0186598	IVECO TRUCK	5-18	4374600005	0507612	MERCEDES	7-22
42488722	0907259	IVECO BUS	14-6	4374600105	0507612	MERCEDES	7-22
42488722	0907259	IVECO TRUCK	5-21	4381927	0403869	VEICOLI COMMERCIALI - LCV VEHICLE	1-26
42489395	0196598	IVECO TRUCK	5-18	4388159	0400097	IVECO TRUCK	5-34
42489573	0186598	IVECO BUS	14-4	4388159	0400097	VEICOLI COMMERCIALI - LCV VEHICLE	1-11
42489594	0186598	IVECO BUS	14-4	4391813	0380405	VEICOLI COMMERCIALI - LCV VEHICLE	1-11
42489594	0186598	IVECO TRUCK	5-18	4391814	0390405	VEICOLI COMMERCIALI - LCV VEHICLE	1-12
42491638	0186598	IVECO BUS	14-4	4401910	0401523	VEICOLI COMMERCIALI - LCV VEHICLE	1-58
42491937	0186595	IVECO TRUCK	5-17	4404048	0381494	VEICOLI COMMERCIALI - LCV VEHICLE	1-55
42491957	0196598	IVECO TRUCK	5-18	4408474	0604424-K	VEICOLI COMMERCIALI - LCV VEHICLE	1-61
42493431	0907330	IVECO TRUCK	5-21	4408474 *	0604424	VEICOLI COMMERCIALI - LCV VEHICLE	1-61
42493781	0186424	IVECO TRUCK	5-18	4408476	0903807	VEICOLI COMMERCIALI - LCV VEHICLE	1-61
42493782	0196424	IVECO TRUCK	5-18	4408476 *	1211589	VEICOLI COMMERCIALI - LCV VEHICLE	1-61
42530316	0287320	IVECO TRUCK	5-16	4408511	0283875	VEICOLI COMMERCIALI - LCV VEHICLE	1-61
42530929	0907583	IVECO BUS	14-8	4408904	0503878	VEICOLI COMMERCIALI - LCV VEHICLE	1-63
42532294	0287313	IVECO TRUCK	5-16	4408958	0793808	VEICOLI COMMERCIALI - LCV VEHICLE	1-62
42532977	0607552	VEICOLI COMMERCIALI - LCV VEHICLE	1-34	4408959	0783808	VEICOLI COMMERCIALI - LCV VEHICLE	1-61
4253300003	0507636	MERCEDES	7-1	4417177	0394627	VEICOLI COMMERCIALI - LCV VEHICLE	1-62
42533073	0287361	IVECO TRUCK	5-16	4417178	0384627	VEICOLI COMMERCIALI - LCV VEHICLE	1-62
42533101	0287360	IVECO TRUCK	5-16	4418212	0391494	VEICOLI COMMERCIALI - LCV VEHICLE	1-55
42533102	0287906	IVECO TRUCK	5-16	4418213	0381494	VEICOLI COMMERCIALI - LCV VEHICLE	1-55
42533102	0287906	MAN	6-11	4418225	0394627	VEICOLI COMMERCIALI - LCV VEHICLE	1-62
42534911	0287552	IVECO BUS	14-4	4418226	0384627	VEICOLI COMMERCIALI - LCV VEHICLE	1-62
42534911	0287552	VEICOLI COMMERCIALI - LCV VEHICLE	1-31	4419215	0391536	VEICOLI COMMERCIALI - LCV VEHICLE	1-60
42535445	0907339	IVECO BUS	14-6	4419216	0381536	VEICOLI COMMERCIALI - LCV VEHICLE	1-59
42536819	0907362	IVECO BUS	14-8				
42536819	0907362	NEOPLAN BUS	17-10				
42537936	0186598	IVECO BUS	14-4				
42537936	0186598	IVECO TRUCK	5-18				
42538047	0287320	IVECO TRUCK	5-16				
42538048	0289923	DAF-LEYLAND DAF	3-8				
42538048	0289923	IVECO TRUCK	5-16				
42538048	0289923	MAN	6-11				
42538048	0289923	VOLVO	11-14				
4254600105	0507612	MERCEDES	7-22				
4254600205	0507612	MERCEDES	7-22				
4254600305	0507612	MERCEDES	7-22				
4254600405	0507612	MERCEDES	7-22				
42551289	0797250	VEICOLI COMMERCIALI - LCV VEHICLE	1-32				
42551290	0787250	VEICOLI COMMERCIALI - LCV VEHICLE	1-32				



Cross Reference Guide

RIF. ORIG O.E. NUMBER	RIF. OCAP REF. OCAP	MARCA	PAG.	RIF. ORIG O.E. NUMBER	RIF. OCAP REF. OCAP	MARCA	PAG.
4419217 Z	1216016	VEICOLI COMMERCIALI - LCV VEHICLE	1-60	4514235	0286610	FIAT - OM	4-7
4419218 Z	1216017	VEICOLI COMMERCIALI - LCV VEHICLE	1-60	4514236	0296610	FIAT - OM	4-8
4419219	0401536	VEICOLI COMMERCIALI - LCV VEHICLE	1-59	4514245	0286650	FIAT - OM	4-7
4419291	0501536	VEICOLI COMMERCIALI - LCV VEHICLE	1-60	4519467	0503254	VEICOLI COMMERCIALI - LCV VEHICLE	1-28
4419304	0501496	VEICOLI COMMERCIALI - LCV VEHICLE	1-60	4520694	0506712	FIAT - OM	4-1
4420096	0901536	VEICOLI COMMERCIALI - LCV VEHICLE	1-59	4520697	0186657	FIAT - OM	4-6
4420096 Z	0601536	VEICOLI COMMERCIALI - LCV VEHICLE	1-59	4520698	0506753	FIAT - OM	4-1
4420097	0291536	VEICOLI COMMERCIALI - LCV VEHICLE	1-59	4520744	0506984	FIAT - OM	4-4
4420098	0281536	VEICOLI COMMERCIALI - LCV VEHICLE	1-59	4523292	0196605	FIAT - OM	4-6
4421646	0384627	VEICOLI COMMERCIALI - LCV VEHICLE	1-62	4533777	0286666	FIAT - OM	4-7
4421647	0394627	VEICOLI COMMERCIALI - LCV VEHICLE	1-62	4536229	0286659	FIAT - OM	4-5
4422269	0393875	VEICOLI COMMERCIALI - LCV VEHICLE	1-65	4540774	0783869	VEICOLI COMMERCIALI - LCV VEHICLE	1-27
4422270	0383875	VEICOLI COMMERCIALI - LCV VEHICLE	1-64	4540775	0793869	VEICOLI COMMERCIALI - LCV VEHICLE	1-27
4422270 *	0403875	VEICOLI COMMERCIALI - LCV VEHICLE	1-64	4544893	0186653	FIAT - OM	4-5
4431869	0404627	VEICOLI COMMERCIALI - LCV VEHICLE	1-62	4545422	0506987	FIAT - OM	4-3
4440885	0503872	VEICOLI COMMERCIALI - LCV VEHICLE	1-28	4546822	0507154	FIAT - OM	4-3
445599	0807455	SCANIA BUS	19-4	4557357	0507167	IVECO BUS	14-2
445626	0509889	SCANIA BUS	19-7	4562450	0186651	FIAT - OM	4-5
445631	0807773	SCANIA	10-14	4568702	0506977	FIAT - OM	4-2
445632	0807773	SCANIA	10-14	4573092	0507154	FIAT - OM	4-3
445634	0807772	SCANIA	10-12	4574457	0506981	FIAT - OM	4-3
4463926	0807282	IVECO TRUCK	5-25	4579231	0186614	IVECO TRUCK	5-16
4500090	0401523	VEICOLI COMMERCIALI - LCV VEHICLE	1-58	4579232	0196614	IVECO TRUCK	5-17
4500092	0391494	VEICOLI COMMERCIALI - LCV VEHICLE	1-55	4580778	0186684	FIAT - OM	4-6
4500093	0381494	VEICOLI COMMERCIALI - LCV VEHICLE	1-55	4580782	0187152	FIAT - OM	4-7
4500094	1215609	VEICOLI COMMERCIALI - LCV VEHICLE	1-56	4582159	0286652	FIAT - OM	4-7
4500095	1215610	VEICOLI COMMERCIALI - LCV VEHICLE	1-56	4588688	0506976	FIAT - OM	4-2
4500198	0593812	VEICOLI COMMERCIALI - LCV VEHICLE	1-56	4603300435	0182260	MERCEDES BUS	16-8
4500199	0583812	VEICOLI COMMERCIALI - LCV VEHICLE	1-56	4603301235	0182260	MERCEDES	7-25
4500255	0401494	VEICOLI COMMERCIALI - LCV VEHICLE	1-55	4603301235	0182260	MERCEDES BUS	16-8
4501260	0903811	VEICOLI COMMERCIALI - LCV VEHICLE	1-59	4603301235	0182260	VEICOLI COMMERCIALI - LCV VEHICLE	1-36
4501260 Z	1211392	VEICOLI COMMERCIALI - LCV VEHICLE	1-59	4603301335	0182260	MERCEDES BUS	16-8
4501261	0603811-K	VEICOLI COMMERCIALI - LCV VEHICLE	1-57	4608505	0507977	MERCEDES	7-24
4501262	0291495	VEICOLI COMMERCIALI - LCV VEHICLE	1-55	4624032	0506720	FIAT - OM	4-4
4501263	0281495	VEICOLI COMMERCIALI - LCV VEHICLE	1-55	4624116	0506721	FIAT - OM	4-4
4510017	0286606	FIAT - OM	4-7	4626261	0507192	IVECO TRUCK	5-23
4510018	0296606	FIAT - OM	4-7	4626917	0506709	FIAT - OM	4-2
4510019	0186605	FIAT - OM	4-6	463245	0509886	SCANIA	10-19
4510620	0186605	FIAT - OM	4-6	463245	0509886	SCANIA BUS	19-7
				463435	0807453	SCANIA BUS	19-5
				465816	0807554	SCANIA	10-12
				4659860	0506774	IVECO BUS	14-3
				4661613	0186620	IVECO BUS	14-5
				4661614	0196620	IVECO BUS	14-5
				466336	0507998	SCANIA BUS	19-1
				4663787	0186603	FIAT - OM	4-5
				4663791	0196603	FIAT - OM	4-5
				4663972	0186604	FIAT - OM	4-5
				4663974	0196604	FIAT - OM	4-5
				4664088	0287151	FIAT - OM	4-6
				4664090	0287150	FIAT - OM	4-6
				4664092	0287151	FIAT - OM	4-6
				4664292	0186605	FIAT - OM	4-6
				4664295	0196605	FIAT - OM	4-6
				4664297	0186605	FIAT - OM	4-6

Cross Reference Guide

RIF. ORIG O.E. NUMBER	RIF. OCAP REF. OCAP	MARCA	PAG.	RIF. ORIG O.E. NUMBER	RIF. OCAP REF. OCAP	MARCA	PAG.
4664297	0186605	IVECO BUS	14-5	4716799	0807257	IVECO TRUCK	5-26
4664340	0187166	IVECO BUS	14-5	4719609	0807283	IVECO TRUCK	5-30
4664341	0197166	IVECO BUS	14-5	4720262	0507284	IVECO TRUCK	5-15
4664343	0186653	FIAT - OM	4-5	4722108	0507161	IVECO TRUCK	5-13
4664345	0186651	FIAT - OM	4-5	4732041	0286610	FIAT - OM	4-7
4664347	0296606	FIAT - OM	4-7	4732042	0296610	FIAT - OM	4-8
4664349	0286606	FIAT - OM	4-7	4732546	0506720	FIAT - OM	4-4
4664351	0296610	FIAT - OM	4-8	4732549	0506721	FIAT - OM	4-4
4664353	0286610	FIAT - OM	4-7	4733704	0506750	FIAT - OM	4-4
4664460	0286650	FIAT - OM	4-7	4733752	0506723	FIAT - OM	4-4
4664462	0286652	FIAT - OM	4-7	4738069	0807210	IVECO BUS	14-6
4664586	0186657	FIAT - OM	4-6	4741171	0507165	IVECO TRUCK	5-36
4665005	0186649	FIAT - OM	4-6	4747690	0506840	IVECO TRUCK	5-14
4665007	0186648	FIAT - OM	4-6	4747960	0506840	IVECO TRUCK	5-14
4665009	0286647	FIAT - OM	4-6	4747961	0506840	IVECO TRUCK	5-14
4665085	0506709	FIAT - OM	4-2	4765442	0506764	IVECO TRUCK	5-15
4665209	0506710	FIAT - OM	4-2	4773359	0506820	IVECO TRUCK	5-14
4665422	0286658	FIAT - OM	4-8	4793166	0506826	IVECO TRUCK	5-13
4665501	0506711	FIAT - OM	4-2	4802443	0186598	IVECO BUS	14-4
4666933	0506723	FIAT - OM	4-4	4802443	0186598	IVECO TRUCK	5-18
4666954	0506720	FIAT - OM	4-4	4802444	0196598	IVECO TRUCK	5-18
4666991	0506750	FIAT - OM	4-4	4815933	0506915	IVECO TRUCK	5-11
4667156	0506721	FIAT - OM	4-4	4822291	0596419	IVECO BUS	14-1
466801	0807554	SCANIA	10-12	4826513	0586419	IVECO BUS	14-1
4668206	0286658	FIAT - OM	4-8	4827082	0586419	IVECO BUS	14-1
4668258	0506971	FIAT - OM	4-4	482779	0507771	SCANIA	10-7
4668368	0286659	FIAT - OM	4-5	4833820	0186424	IVECO TRUCK	5-18
4668402	0506984	FIAT - OM	4-4	4833821	0196424	IVECO TRUCK	5-18
4668771	0507168	IVECO BUS	14-3	4833825	0186613	IVECO TRUCK	5-17
466880	0509880	SCANIA BUS	19-2	4833826	0196613	IVECO TRUCK	5-17
466881	0506938	SCANIA BUS	19-1	4833827	0186424	IVECO TRUCK	5-18
4669091	0506712	FIAT - OM	4-1	4833828	0196424	IVECO TRUCK	5-18
4669094	0506753	FIAT - OM	4-1	4833829	0186598	IVECO TRUCK	5-18
4670853	0507192	IVECO TRUCK	5-23	4833830	0196598	IVECO TRUCK	5-18
4672795	0506781	IVECO BUS	14-3	4834037	0506820	IVECO TRUCK	5-14
468285	0196598	SCANIA	10-9	4834041	0506826	IVECO TRUCK	5-13
468285	0196598	SCANIA BUS	19-3	4835068	0506553	IVECO TRUCK	5-3
468286	0186598	SCANIA	10-9	483527	0509890	SCANIA BUS	19-7
468286	0186598	SCANIA BUS	19-3	4838587	0596419	IVECO BUS	14-1
4688941	0186608	IVECO TRUCK	5-18	4844041	0506994	IVECO TRUCK	5-3
4688942	0196608	IVECO TRUCK	5-18	48520-00QAH	0291495	VEICOLI COMMERCIALI - LCV VEHICLE	1-55
4688944	0187160	IVECO TRUCK	5-19	48520-00QAJ	0281495	VEICOLI COMMERCIALI - LCV VEHICLE	1-55
4688946	0287159	IVECO TRUCK	5-19	485200780R	0281536	VEICOLI COMMERCIALI - LCV VEHICLE	1-59
4688948	0186599	IVECO BUS	14-4	485206730R	0291536	VEICOLI COMMERCIALI - LCV VEHICLE	1-59
4688948	0186599	IVECO TRUCK	5-19	48521-00QAF	0603811	VEICOLI COMMERCIALI - LCV VEHICLE	1-55
4688949	0196599	IVECO TRUCK	5-19	485212373R	0601536	VEICOLI COMMERCIALI - LCV VEHICLE	1-59
4688951	0186656	IVECO TRUCK	5-19	4854871	0506953	IVECO TRUCK	5-3
4688952	0186655	IVECO TRUCK	5-19	4854874	0506952	IVECO TRUCK	5-9
4692686	0506714	FIAT - OM	4-2	4855237	0807286	IVECO TRUCK	5-30
4699246	0506716	IVECO TRUCK	5-13	4862449	0586419	IVECO BUS	14-1
4699305	0506717	IVECO TRUCK	5-10	4862451	0586419	IVECO BUS	14-1
470272	0507189	SCANIA BUS	19-2	488738	0509913	SCANIA BUS	19-7
4704183	0506810	IVECO TRUCK	5-12	489037	0807901	SCANIA BUS	19-4
4704239	0507169	IVECO BUS	14-2	489986	0809879	SCANIA BUS	19-5
4714134	0807207	IVECO TRUCK	5-21				
4715615	0506839	IVECO TRUCK	5-11				
4716271	0807208	IVECO TRUCK	5-25				
4716557	0507169	IVECO BUS	14-2				

Cross Reference Guide

RIF. ORIG O.E. NUMBER	RIF. OCAP REF. OCAP	MARCA	PAG.	RIF. ORIG O.E. NUMBER	RIF. OCAP REF. OCAP	MARCA	PAG.
489987	0807554	SCANIA	10-12	5000640089	0807673	RENAULT V.I. BUS	18-4
489989	0807455	SCANIA BUS	19-4	5000725267	0506676	RENAULT V.I.	9-8
4941233	0907359	VOLVO	11-17	5000725268	0507674	RENAULT V.I.	9-8
50 01 852 452	0187723	RENAULT V.I.	9-14	5000745719	0506677	RENAULT V.I.	9-9
50 01 858 763	0187723	RENAULT V.I.	9-14	5000748784	0506642	RENAULT V.I.	9-9
5000027957	0807551	RENAULT V.I.	9-18	5000748868	0506642	RENAULT V.I.	9-9
5000240688	0186598	RENAULT V.I.	9-13	5000750976	0807252	RENAULT V.I.	9-18
5000242159	0186424	RENAULT V.I.	9-12	5000761670	0506692	RENAULT V.I. BUS	18-2
5000242159	0186424	RENAULT V.I. BUS	18-3	5000761671	0507678	RENAULT V.I. BUS	18-2
5000242478	0196598	RENAULT V.I.	9-13	5000761673	0507989	RENAULT V.I. BUS	18-1
5000242479	0186598	RENAULT V.I.	9-13	5000783574	0807252	RENAULT V.I.	9-18
5000242485	0186598	RENAULT V.I.	9-13	5000783889	0506642	RENAULT V.I.	9-9
5000246729	0401398	VEICOLI COMMERCIALI - LCV VEHICLE	1-88	5000785429	0506751	RENAULT V.I.	9-6
5000246730	0401399	VEICOLI COMMERCIALI - LCV VEHICLE	1-88	5000786379	0597992	RENAULT V.I. BUS	18-7
5000246731	0400951	VEICOLI COMMERCIALI - LCV VEHICLE	1-88	5000786527	0506692	RENAULT V.I. BUS	18-2
5000246732	0400952	VEICOLI COMMERCIALI - LCV VEHICLE	1-88	5000786768	0507744	RENAULT V.I. BUS	18-2
5000253852	0186598	RENAULT V.I.	9-13	5000786902	0506695	RENAULT V.I.	9-2
5000275496	0186598	RENAULT V.I.	9-13	5000787304	0506676	RENAULT V.I.	9-8
5000288360	0186598	RENAULT V.I.	9-13	5000787305	0506676	RENAULT V.I.	9-8
5000288360	0186598	RENAULT V.I. BUS	18-3	5000787306	0506676	RENAULT V.I.	9-8
5000288361	0196598	RENAULT V.I.	9-13	5000787472	0506680	RENAULT V.I.	9-5
5000288362	0286641	RENAULT V.I.	9-15	5000787496	0807252	RENAULT V.I.	9-18
5000288363	0296641	RENAULT V.I.	9-15	5000791330	0506677	RENAULT V.I.	9-9
5000288364	0287892	RENAULT V.I.	9-14	5000793641	0907264	RENAULT V.I.	9-28
5000288365	0297892	RENAULT V.I.	9-14	5000793828	0927446	RENAULT V.I.	9-27
5000295214	0186424	RENAULT V.I.	9-12	5000793849	0927444	RENAULT V.I.	9-26
5000295214	0186424	RENAULT V.I. BUS	18-3	5000794318	0927447	RENAULT V.I.	9-27
5000295215	0196424	RENAULT V.I.	9-12	5000794319	0927445	RENAULT V.I.	9-27
5000297580	0187900	RENAULT V.I.	9-15	5000794320	0927443	RENAULT V.I.	9-26
5000297581	0197756	RENAULT V.I.	9-15	5000802123	0907678	RENAULT V.I.	9-18
5000297668	0287753	RENAULT V.I.	9-15	5000803459	0297350	RENAULT V.I.	9-15
5000297669	0297753	RENAULT V.I.	9-15	5000803460	0287350	RENAULT V.I.	9-15
5000333285	0907362	IVECO BUS	14-8	5000803464	0287752	RENAULT V.I.	9-14
5000333285	0907362	NEOPLAN BUS	17-10	5000803465	0297752	RENAULT V.I.	9-14
5000336305	0907263	RENAULT V.I.	9-27	5000804824	0186598	RENAULT V.I.	9-13
5000350120	0506904	RENAULT V.I.	9-1	5000804824	0186598	RENAULT V.I. BUS	18-3
5000352082	0506690	RENAULT V.I.	9-7	5000807536	0187228	RENAULT V.I.	9-25
5000352083	0506690	RENAULT V.I.	9-7	5000807553	0196595	RENAULT V.I.	9-11
5000393080	0506595	RENAULT V.I.	9-1	5000807554	0186595	RENAULT V.I.	9-11
5000393204	0506595	RENAULT V.I.	9-1	5000808458	0187146	RENAULT V.I.	9-14
5000395296	0507202	RENAULT V.I.	9-4	5000810038	0807551	RENAULT V.I.	9-18
5000395435	0507202	RENAULT V.I.	9-4	5000812483	0186424	RENAULT V.I.	9-12
5000446681	0506699	RENAULT V.I.	9-1	5000812483	0186424	RENAULT V.I. BUS	18-3
5000450713	0587990	RENAULT V.I.	9-24	5000814096	0196595	RENAULT V.I.	9-11
5000450714	0597990	RENAULT V.I.	9-24	5000814097	0186595	RENAULT V.I.	9-11
5000489779	0407219	RENAULT V.I. BUS	18-6	5000816456	0297892	RENAULT V.I.	9-14
5000516214	0187228	RENAULT V.I.	9-25	5000819349	0186598	RENAULT V.I.	9-13
5000541224	0506904	RENAULT V.I.	9-1	5000819365	0907749	RENAULT V.I.	9-16
5000541230	0506690	RENAULT V.I.	9-7	5000819413	0907595	RENAULT V.I.	9-17
5000559335	0186424	RENAULT V.I.	9-12	5000823947	0196613	RENAULT V.I.	9-12
5000559335	0186424	RENAULT V.I. BUS	18-3	5000823987	0186424	RENAULT V.I.	9-12
5000590236	0186598	RENAULT V.I.	9-13	5000823997	0196613	RENAULT V.I.	9-12
5000590236	0186598	RENAULT V.I. BUS	18-3	5000869572	0807753	RENAULT V.I.	9-17
5000613837	0506697	RENAULT V.I.	9-1	5000869573	0807756	RENAULT V.I.	9-20
5000614223	0506595	RENAULT V.I.	9-1	5000869619	0807673	RENAULT V.I. BUS	18-4
				5000869761	0587992	RENAULT V.I. BUS	18-7
				5000869762	0597992	RENAULT V.I. BUS	18-7
				5000869763	0507993	RENAULT V.I. BUS	18-7

Cross Reference Guide

RIF. ORIG O.E. NUMBER	RIF. OCAP REF. OCAP	MARCA	PAG.	RIF. ORIG O.E. NUMBER	RIF. OCAP REF. OCAP	MARCA	PAG.
5000874577	0506642	RENAULT V.I.	9-9	500310933	0280517	IVECO TRUCK	5-34
5000874578	0506642	RENAULT V.I.	9-9	500324282	0507859	IVECO TRUCK	5-6
5000932435	0506688	RENAULT V.I.	9-5	500333284	0907407	IVECO TRUCK	5-33
5000932435	0506693	RENAULT V.I. BUS	18-2	500333284	0907407	MAN BUS	15-8
5000998430	0506694	RENAULT V.I. BUS	18-2	500333284	0907407	NEOPLAN BUS	17-12
5001000134	0297229	RENAULT V.I.	9-25	500334713	0407249	IVECO TRUCK	5-35
5001014520	0907406	RENAULT V.I.	9-22	500334714	0407249	IVECO TRUCK	5-35
5001823279	0907677	RENAULT V.I.	9-19	500334716	0407250	IVECO TRUCK	5-35
5001823280	0907676	RENAULT V.I.	9-19	500334716	0787250	VEICOLI COMMERCIALI - LCV VEHICLE	1-32
5001825687	0186613	RENAULT V.I.	9-11	500334717	0407250	IVECO TRUCK	5-35
5001829030	0507744	RENAULT V.I. BUS	18-2	500334717	0797250	VEICOLI COMMERCIALI - LCV VEHICLE	1-32
5001831473	0186424	RENAULT V.I.	9-12	500336085	0507367	IVECO TRUCK	5-9
5001831473	0186424	RENAULT V.I. BUS	18-3	500337201	0286616	VEICOLI COMMERCIALI - LCV VEHICLE	1-31
5001831481	0186599	RENAULT V.I.	9-13	500340451	0807299	IVECO TRUCK	5-29
5001831526	0907678	RENAULT V.I.	9-18	500340452	0807292	IVECO TRUCK	5-22
5001832579	0196599	RENAULT V.I.	9-13	500344887	0407249	IVECO TRUCK	5-35
5001832580	0186599	RENAULT V.I.	9-13	500344888	0407249	IVECO TRUCK	5-35
5001832581	0196598	RENAULT V.I.	9-13	500345518	1216308	IVECO BUS	14-12
5001832582	0186424	RENAULT V.I.	9-12	500362533	0507852	IVECO BUS	14-3
5001832582	0186424	RENAULT V.I. BUS	18-3	500362533	0507852	IVECO TRUCK	5-14
5001834533	0196424	RENAULT V.I.	9-12	500363545	0507853	IVECO BUS	14-2
5001836297	0196598	RENAULT V.I.	9-13	500363545	0507853	IVECO TRUCK	5-14
5001836298	0186598	RENAULT V.I.	9-13	500379801	0407249	IVECO TRUCK	5-35
5001836298	0186598	RENAULT V.I. BUS	18-3	500379801	0797249	VEICOLI COMMERCIALI - LCV VEHICLE	1-32
5001836801	0180730	RENAULT V.I.	9-11	500379802	0407249	IVECO TRUCK	5-35
5001842337	0907219	RENAULT V.I.	9-17	500379802	0787249	VEICOLI COMMERCIALI - LCV VEHICLE	1-32
5001842337 *	0907739	RENAULT V.I.	9-19	500383975	0587871	VEICOLI COMMERCIALI - LCV VEHICLE	1-33
5001842823	0907259	RENAULT V.I.	9-18	500383976	0597871	VEICOLI COMMERCIALI - LCV VEHICLE	1-33
5001842823	0907259	RENAULT V.I. BUS	18-4	500397738	0507369	IVECO TRUCK	5-12
5001844136	0186595	RENAULT V.I.	9-11	500559335	0186613	RENAULT V.I.	9-11
5001847026	0907845	MAN BUS	15-10	500559336	0196613	RENAULT V.I.	9-12
5001847026	0907845	NEOPLAN BUS	17-11	5006305888	0809921	IVECO BUS	14-7
5001847436	0196595	RENAULT V.I.	9-11	5006305890	0809925	IVECO BUS	14-6
5001849879	0287361	RENAULT V.I.	9-11	5006305892	0809924	IVECO BUS	14-6
5001849880	0287360	RENAULT V.I.	9-11	5006305917	1216307	IVECO BUS	14-12
5001850530	0807252	RENAULT V.I.	9-18	5006306002	0589922	IVECO BUS	14-10
5001850550	0196424	RENAULT V.I.	9-12	5006306003	0599922	IVECO BUS	14-10
5001850588	0907362	IVECO BUS	14-8	5006306531	0858055	IVECO BUS	14-10
5001850588	0907362	NEOPLAN BUS	17-10	5010005937	0807752	RENAULT V.I.	9-16
5001852263	0196424	RENAULT V.I.	9-12	5010013397	0807756	RENAULT V.I.	9-20
5001852452	0187723	RENAULT V.I.	9-14	5010013398	0807753	RENAULT V.I.	9-17
5001855163	0507677	RENAULT V.I.	9-6	5010014345	0907252	RENAULT V.I.	9-17
5001858756	0196595	RENAULT V.I.	9-11	5010037418	0506686	RENAULT V.I.	9-7
5001858763	0187723	RENAULT V.I.	9-14	5010037602	0506686	RENAULT V.I.	9-7
5001858773	0186598	RENAULT V.I.	9-13	5010037603	0506686	RENAULT V.I.	9-7
5001858773	0186598	RENAULT V.I. BUS	18-3	5010060764	0506679	RENAULT V.I.	9-4
5001858774	0196598	RENAULT V.I.	9-13	5010064641	0807252	RENAULT V.I.	9-18
5001860123	0186595	RENAULT V.I.	9-11	5010064715	0507755	RENAULT V.I.	9-5
5001860300	0907362	IVECO BUS	14-8	5010092170	0506677	RENAULT V.I.	9-9
5001860300	0907362	NEOPLAN BUS	17-10	5010092191	0506677	RENAULT V.I.	9-9
5001860359	0506695	RENAULT V.I.	9-2	5010094838	0807252	RENAULT V.I.	9-18
5001860769	0196595	RENAULT V.I.	9-11	5010094839	0807676	RENAULT V.I.	9-18
5001860770	0187884	RENAULT V.I.	9-11	5010094840	0807219	RENAULT V.I.	9-19
5001866165	0187903	RENAULT V.I.	9-13				
5001867774	0187903	RENAULT V.I.	9-13				
500307556	0506950	IVECO TRUCK	5-2				
500308895	0507367	IVECO TRUCK	5-9				
500309296	0187364	IVECO TRUCK	5-19				



Cross Reference Guide

RIF. ORIG O.E. NUMBER	RIF. OCAP REF. OCAP	MARCA	PAG.	RIF. ORIG O.E. NUMBER	RIF. OCAP REF. OCAP	MARCA	PAG.
5010094941	0807252	RENAULT V.I.	9-18	5010239386	0506678	RENAULT V.I.	9-9
5010097562	0506904	RENAULT V.I.	9-1	5010239387	0506691	RENAULT V.I.	9-10
5010098467	0507849	RENAULT V.I.	9-3	5010245591	0187228	RENAULT V.I.	9-25
50101030452	0506642	RENAULT V.I.	9-9	5010253255	0597991	RENAULT V.I.	9-24
5010104286	0507989	RENAULT V.I. BUS	18-1	5010253256	0587991	RENAULT V.I.	9-24
5010104289	0506692	RENAULT V.I. BUS	18-2	5010268035	0807678	RENAULT V.I.	9-18
5010104365	0907749	RENAULT V.I.	9-16	5010291903	0507865	RENAULT V.I.	9-2
5010129530	0287229	RENAULT V.I.	9-25	5010294287	0506681	RENAULT V.I.	9-5
5010130344	0506688	RENAULT V.I.	9-5	5010294288	0506684	RENAULT V.I.	9-5
5010130382	0507755	RENAULT V.I.	9-5	5010294289	0506685	RENAULT V.I.	9-6
5010130383	0507740	RENAULT V.I.	9-4	5010294502	0506682	RENAULT V.I.	9-6
5010130393	0506683	RENAULT V.I.	9-6	5010294720	0507854	RENAULT V.I.	9-6
5010130446	0506686	RENAULT V.I.	9-7	5010305367	0507863	RENAULT V.I.	9-8
5010130447	0506686	RENAULT V.I.	9-7	5010308082	0506754	RENAULT V.I.	9-2
5010130451	0507673	RENAULT V.I.	9-9	5010308215	0507987	RENAULT V.I.	9-2
5010130453	0506642	RENAULT V.I.	9-9	5010347099	0807750	RENAULT V.I. BUS	18-4
5010130456	0506686	RENAULT V.I.	9-7	5010383097	0507985	RENAULT V.I.	9-7
5010130483	0506680	RENAULT V.I.	9-5	5010383529	0507988	RENAULT V.I.	9-8
5010130710	0507765	RENAULT V.I.	9-9	5010389262	0807674	RENAULT V.I.	9-17
5010130739	0506678	RENAULT V.I.	9-9	5010393047	0907362	IVECO BUS	14-8
5010130740	0506691	RENAULT V.I.	9-10	5010393047	0907362	NEOPLAN BUS	17-10
5010138060	0506642	RENAULT V.I.	9-9	5010393672	0407219	RENAULT V.I. BUS	18-6
5010138446	0506642	RENAULT V.I.	9-9	5010439021	0507858	RENAULT V.I.	9-3
5010138691	0506642	RENAULT V.I.	9-9	5010439022	0507856	RENAULT V.I.	9-3
5010144543	0187228	RENAULT V.I.	9-25	5010439023	0507865	RENAULT V.I.	9-2
5010144549	0506676	RENAULT V.I.	9-8	5010439631	0507849	RENAULT V.I.	9-3
5010144551	0506677	RENAULT V.I.	9-9	5010467915	0807219	RENAULT V.I.	9-19
5010144552	0506676	RENAULT V.I.	9-8	5010488052	0506687	RENAULT V.I.	9-7
5010144554	0507674	RENAULT V.I.	9-8	5010488097	0507988	RENAULT V.I.	9-8
5010144556	0506677	RENAULT V.I.	9-9	5010488146	0507220	RENAULT V.I.	9-8
5010144557	0506677	RENAULT V.I.	9-9	5010488164	0507861	RENAULT V.I.	9-7
5010145077	0506695	RENAULT V.I.	9-2	5010488165	0507862	RENAULT V.I.	9-7
5010145584	0507849	RENAULT V.I.	9-3	5010488167	0507863	RENAULT V.I.	9-8
5010151409	0587992	RENAULT V.I. BUS	18-7	5010488464	0507884	RENAULT V.I.	9-4
5010151410	0597992	RENAULT V.I. BUS	18-7	5010556210	0409919	IVECO BUS	14-9
5010151411	0507993	RENAULT V.I. BUS	18-7	5010557243	0506679	RENAULT V.I.	9-4
5010151528	0507678	RENAULT V.I. BUS	18-2	5010566049	0507864	RENAULT V.I.	9-1
5010151529	0506692	RENAULT V.I. BUS	18-2	5010566058	0507987	RENAULT V.I.	9-2
5010163161	0506686	RENAULT V.I.	9-7	5010566059	0507855	RENAULT V.I.	9-3
5010163162	0506686	RENAULT V.I.	9-7	5010566062	0507865	RENAULT V.I.	9-2
5010163163	0506686	RENAULT V.I.	9-7	5010566063	0507858	RENAULT V.I.	9-3
5010174785	0506694	RENAULT V.I. BUS	18-2	5010566064	0507856	RENAULT V.I.	9-3
5010174787	0506688	RENAULT V.I.	9-5	5010832582	0186598	RENAULT V.I.	9-13
5010174787	0506693	RENAULT V.I. BUS	18-2	5010832582	0186598	RENAULT V.I. BUS	18-3
5010190148	0507986	RENAULT V.I. BUS	18-1	5010832583	0196598	RENAULT V.I.	9-13
5010199642	0507888	IVECO BUS	14-10	504034521	0507866	IVECO TRUCK	5-15
5010199642	0507888	RENAULT V.I. BUS	18-7	504039506	1215953	VEICOLI COMMERCIALI - LCV VEHICLE	1-32
5010207724	0507678	RENAULT V.I. BUS	18-2	504049893	0507368	IVECO TRUCK	5-10
5010207725	0506692	RENAULT V.I. BUS	18-2	504126384	0509918	IVECO BUS	14-1
5010207726	0807753	RENAULT V.I.	9-17	504201479	0409919	IVECO BUS	14-9
5010207727	0807756	RENAULT V.I.	9-20	504212586	0407893	VEICOLI COMMERCIALI - LCV VEHICLE	1-34
5010207728	0507989	RENAULT V.I. BUS	18-1	50705629	0402638	VEICOLI COMMERCIALI - LCV VEHICLE	1-5
5010207771	0807749	RENAULT V.I.	9-16	5081N9 Z	0182638	VEICOLI COMMERCIALI - LCV VEHICLE	1-6
5010224898	0506595	RENAULT V.I.	9-1	508735	0181322	VEICOLI COMMERCIALI - LCV VEHICLE	1-8
5010224899	0506699	RENAULT V.I.	9-1				
5010229242	0506687	RENAULT V.I.	9-7				
5010238594	0597991	RENAULT V.I.	9-24				
5010239340	0506678	RENAULT V.I.	9-9				

Cross Reference Guide

RIF. ORIG O.E. NUMBER	RIF. OCAP REF. OCAP	MARCA	PAG.	RIF. ORIG O.E. NUMBER	RIF. OCAP REF. OCAP	MARCA	PAG.
508735 *	0181322-K	VEICOLI COMMERCIALI - LCV VEHICLE	1-7	550806	0907528	SCANIA	10-11
508756	0502735	VEICOLI COMMERCIALI - LCV VEHICLE	1-10	550806	0907528	SCANIA BUS	19-4
525443	0506430	DAF-LEYLAND DAF	3-5	550807	0907508	SCANIA	10-12
542150011	0395072	VEICOLI COMMERCIALI - LCV VEHICLE	1-35	5508072	0907508	SCANIA	10-12
542150012	0385072	VEICOLI COMMERCIALI - LCV VEHICLE	1-35	550808	0907997	SCANIA	10-12
542180020	0858054	VEICOLI COMMERCIALI - LCV VEHICLE	1-35	5508080	0907997	SCANIA	10-12
542180023	0595068	VEICOLI COMMERCIALI - LCV VEHICLE	1-35	550812	0907405	SCANIA	10-16
542180024	0585068	VEICOLI COMMERCIALI - LCV VEHICLE	1-35	550812	0907405	SCANIA BUS	19-5
542410018	0405069	VEICOLI COMMERCIALI - LCV VEHICLE	1-35	551100019R	0501496	VEICOLI COMMERCIALI - LCV VEHICLE	1-60
542410025	0405069	VEICOLI COMMERCIALI - LCV VEHICLE	1-35	5516017400	0506690	RENAULT V.I.	9-7
5430119888	0507741	RENAULT V.I.	9-4	5516017831	0506690	RENAULT V.I.	9-7
5430122944	0507741	RENAULT V.I.	9-4	554765	0506430	DAF-LEYLAND DAF	3-5
54423-00QAA	1215610	VEICOLI COMMERCIALI - LCV VEHICLE	1-56	574274	0196598	IVECO BUS	14-5
54500-00QAC	0381494	VEICOLI COMMERCIALI - LCV VEHICLE	1-55	579342	0186424	IVECO BUS	14-4
54500-00QAD	0381494	VEICOLI COMMERCIALI - LCV VEHICLE	1-55	579343	0196424	IVECO BUS	14-4
54500-00QAE	0381494	VEICOLI COMMERCIALI - LCV VEHICLE	1-55	5801208436	0409919	IVECO BUS	14-9
545006069R	0383875	VEICOLI COMMERCIALI - LCV VEHICLE	1-64	5801282537	0507365	IVECO TRUCK	5-12
545006069R *	0403875	VEICOLI COMMERCIALI - LCV VEHICLE	1-64	5801282538	0507365	IVECO TRUCK	5-12
54501-00QAC	0391494	VEICOLI COMMERCIALI - LCV VEHICLE	1-55	5801378064	0407894	VEICOLI COMMERCIALI - LCV VEHICLE	1-34
54501-00QAD	0391494	VEICOLI COMMERCIALI - LCV VEHICLE	1-55	5801891027	0509918	IVECO BUS	14-1
54501-00QAE	0391494	VEICOLI COMMERCIALI - LCV VEHICLE	1-55	5801893542	0589922	IVECO BUS	14-10
545019956R	0393875	VEICOLI COMMERCIALI - LCV VEHICLE	1-65	5801893544	0599922	IVECO BUS	14-10
545601173R	1216017	VEICOLI COMMERCIALI - LCV VEHICLE	1-60	581528	0807687	VOLVO	11-19
54570-00QAA	1215609	VEICOLI COMMERCIALI - LCV VEHICLE	1-56	5829067053	0502255	VEICOLI COMMERCIALI - LCV VEHICLE	1-43
54618-00QAA	0583812	VEICOLI COMMERCIALI - LCV VEHICLE	1-56	586753	0186424	DAF-LEYLAND DAF	3-9
54618-00QAB	0593812	VEICOLI COMMERCIALI - LCV VEHICLE	1-56	586753	0186424	DAF BUS	13-1
546180004R	0501536	VEICOLI COMMERCIALI - LCV VEHICLE	1-60	589333	0287229	DAF-LEYLAND DAF	3-22
548588	0927400	DAF-LEYLAND DAF	3-23	6000025546 Z	0903811	VEICOLI COMMERCIALI - LCV VEHICLE	1-59
550257	0927454	SCANIA	10-21	6001547607	1211392	VEICOLI COMMERCIALI - LCV VEHICLE	1-59
550284	0927455	SCANIA	10-21	6003300111	0807417	MERCEDES BUS	16-14
550713	0927452	SCANIA	10-21	60103171	0506613	IVECO TRUCK	5-1
550713	0927452	SCANIA BUS	19-8	6013201389	0502744	VEICOLI COMMERCIALI - LCV VEHICLE	1-41
550714	0927452	SCANIA	10-21	6013210350	1215817	VEICOLI COMMERCIALI - LCV VEHICLE	1-41
550714	0927452	SCANIA BUS	19-8	6013300019	0927412	MERCEDES	7-52
550729	0927453	SCANIA	10-21	6013300435	0180727	VEICOLI COMMERCIALI - LCV VEHICLE	1-42
550729	0927453	SCANIA BUS	19-8	6013300535	0190727	MERCEDES	7-25
550730	0927453	SCANIA	10-21	6013300535	0190727	VEICOLI COMMERCIALI - LCV VEHICLE	1-42
550730	0927453	SCANIA BUS	19-8	6013300635	0180727	MERCEDES	7-25
550732	0927452	SCANIA	10-21	6013300635	0180727	VEICOLI COMMERCIALI - LCV VEHICLE	1-42
550732	0927452	SCANIA BUS	19-8	6013300735	0190727	MERCEDES	7-25
550799	0907528	SCANIA	10-11	6013300735	0190727	VEICOLI COMMERCIALI - LCV VEHICLE	1-42
550799	0907528	SCANIA BUS	19-4	6013305235	0190727	MERCEDES	7-25
				6013305335	0180727	VEICOLI COMMERCIALI - LCV VEHICLE	1-42
				6013305335	0180727	MERCEDES	7-25
				6013305335	0180727	VEICOLI COMMERCIALI - LCV VEHICLE	1-42
				6013325306	0927412	MERCEDES	7-52
				6013743	0506795	IVECO BUS	14-2
				6014300535	0501347	VEICOLI COMMERCIALI - LCV VEHICLE	1-44

**Cross Reference Guide**

RIF. ORIG O.E. NUMBER	RIF. OCAP REF. OCAP	MARCA	PAG.	RIF. ORIG O.E. NUMBER	RIF. OCAP REF. OCAP	MARCA	PAG.
6014600005	0500730	MERCEDES	7-8	6023305735	0192254	VEICOLI COMMERCIALI - LCV VEHICLE	1-43
6014600005	0500730	VEICOLI COMMERCIALI - LCV VEHICLE	1-43	6023305835	0182254	VEICOLI COMMERCIALI - LCV VEHICLE	1-43
6014600105	0500730	MERCEDES	7-8	6025370231	1211392	VEICOLI COMMERCIALI - LCV VEHICLE	1-59
6014600105	0500730	VEICOLI COMMERCIALI - LCV VEHICLE	1-43	6025370231 Z	0903811	VEICOLI COMMERCIALI - LCV VEHICLE	1-59
6014600205	0500730	MERCEDES	7-8	6027074	0187228	VOLVO	11-26
6014600205	0500730	VEICOLI COMMERCIALI - LCV VEHICLE	1-43	606922	0296427	DAF-LEYLAND DAF	3-10
6014600305	0500730	MERCEDES	7-8	606922	0296427	DAF BUS	13-1
6014600305	0500730	VEICOLI COMMERCIALI - LCV VEHICLE	1-43	606923	0286427	DAF-LEYLAND DAF	3-10
6014600505	0502257	MERCEDES	7-8	606923	0286427	DAF BUS	13-1
6014600505	0502257	VEICOLI COMMERCIALI - LCV VEHICLE	1-43	608122	0287519	DAF-LEYLAND DAF	3-12
6014600605	0502257	MERCEDES	7-8	608123	0297519	DAF-LEYLAND DAF	3-13
6014600605	0502257	VEICOLI COMMERCIALI - LCV VEHICLE	1-43	6083200028	0402159	MERCEDES	7-50
6014600705	0502257	MERCEDES	7-8	6083200028	0402159	MERCEDES BUS	16-19
6014600705	0502257	VEICOLI COMMERCIALI - LCV VEHICLE	1-43	6083200028	0402159	VEICOLI COMMERCIALI - LCV VEHICLE	1-37
6014600805	0502257	MERCEDES	7-8	6083200128	0402159	MERCEDES	7-50
6014600805	0502257	VEICOLI COMMERCIALI - LCV VEHICLE	1-43	6083200128	0402159	MERCEDES BUS	16-19
6014600905	0502257	MERCEDES	7-8	6083200128	0402159	VEICOLI COMMERCIALI - LCV VEHICLE	1-37
6014600905	0502257	VEICOLI COMMERCIALI - LCV VEHICLE	1-43	6083300303	0502252	VEICOLI COMMERCIALI - LCV VEHICLE	1-42
6014601005	0502257	MERCEDES	7-8	6083300403	0502255	VEICOLI COMMERCIALI - LCV VEHICLE	1-43
6014601005	0502257	VEICOLI COMMERCIALI - LCV VEHICLE	1-43	6083305535	0192254	VEICOLI COMMERCIALI - LCV VEHICLE	1-43
6014601105	0502257	MERCEDES	7-8	6083305735	0192254	VEICOLI COMMERCIALI - LCV VEHICLE	1-43
6014601105	0502257	VEICOLI COMMERCIALI - LCV VEHICLE	1-43	6083330027	0182252	VEICOLI COMMERCIALI - LCV VEHICLE	1-42
6014601205	0502257	MERCEDES	7-8	6083380110	0192252	VEICOLI COMMERCIALI - LCV VEHICLE	1-42
6014601205	0502257	VEICOLI COMMERCIALI - LCV VEHICLE	1-43	6084600105	0502256	VEICOLI COMMERCIALI - LCV VEHICLE	1-43
6014601305	0502257	MERCEDES	7-8	6113300019	0927411	MERCEDES	7-52
6014601305	0502257	VEICOLI COMMERCIALI - LCV VEHICLE	1-43	6133300003	0507600	MERCEDES BUS	16-2
6014601505	0502257	MERCEDES	7-8	6133300011	0807414	MERCEDES BUS	16-15
6014601505	0502257	VEICOLI COMMERCIALI - LCV VEHICLE	1-43	6133300103	0507144	MERCEDES BUS	16-4
6015865033	0927412	MERCEDES	7-52	6150970	0181724	VEICOLI COMMERCIALI - LCV VEHICLE	1-25
6023300003	0502253	VEICOLI COMMERCIALI - LCV VEHICLE	1-42	6150971	0191724	VEICOLI COMMERCIALI - LCV VEHICLE	1-25
6023300035	0182254	VEICOLI COMMERCIALI - LCV VEHICLE	1-43	61590824	0506746	IVECO TRUCK	5-14
6023300103	0502253	VEICOLI COMMERCIALI - LCV VEHICLE	1-42	61590910	0506741	IVECO TRUCK	5-11
6023300135	0192254	VEICOLI COMMERCIALI - LCV VEHICLE	1-43	61591070	0187158	IVECO TRUCK	5-17
6023300303	0502253	VEICOLI COMMERCIALI - LCV VEHICLE	1-42	61593332	0506743	IVECO TRUCK	5-11
6023300403	0502253	VEICOLI COMMERCIALI - LCV VEHICLE	1-42	61595371	0506745	IVECO TRUCK	5-11
6023300903	0502254	VEICOLI COMMERCIALI - LCV VEHICLE	1-42	61595957	0187158	IVECO TRUCK	5-17
6023301003	0502254	VEICOLI COMMERCIALI - LCV VEHICLE	1-42	61595960	0506746	IVECO TRUCK	5-14
6023305303	0502254	VEICOLI COMMERCIALI - LCV VEHICLE	1-42	61600701	1211073	VEICOLI COMMERCIALI - LCV VEHICLE	1-24
6023305403	0502254	VEICOLI COMMERCIALI - LCV VEHICLE	1-42	6173300203	0507795	MERCEDES	7-4
6023305435	0192254	VEICOLI COMMERCIALI - LCV VEHICLE	1-43	6173300303	0507795	MERCEDES	7-4
6023305535	0182254	VEICOLI COMMERCIALI - LCV VEHICLE	1-43	6174600005	0507626	MERCEDES	7-16
				6174600105	0507825	MERCEDES	7-16
				6174600205	0507626	MERCEDES	7-16
				6174600305	0507825	MERCEDES	7-16
				6174602005	0507592	MERCEDES	7-15
				6174602405	0507592	MERCEDES	7-15
				6174602805	0507626	MERCEDES	7-16

Cross Reference Guide

RIF. ORIG O.E. NUMBER	RIF. OCAP REF. OCAP	MARCA	PAG.	RIF. ORIG O.E. NUMBER	RIF. OCAP REF. OCAP	MARCA	PAG.
6174602905	0507825	MERCEDES	7-16	6254609605	0507700	MERCEDES	7-24
6174603405	0507592	MERCEDES	7-15	6254609805	0507700	MERCEDES	7-24
6174603505	0507666	MERCEDES	7-16	6264600005	0507427	MERCEDES BUS	16-7
6174603605	0507666	MERCEDES	7-16	6273300103	0507421	MERCEDES BUS	16-1
6193500206	0807604	MERCEDES	7-44	6273300203	0507423	MERCEDES BUS	16-1
6194601205	0507804	MERCEDES	7-15	6273300303	0507429	MERCEDES BUS	16-1
6194602505	0506578	MERCEDES	7-15	6273500006	0807413	MERCEDES BUS	16-13
6194602705	0507804	MERCEDES	7-15	6273500106	0807413	MERCEDES BUS	16-13
6194602905	0506578	MERCEDES	7-15	6283200089	0597982	MERCEDES BUS	16-20
6194603105	0507804	MERCEDES	7-15	6283200189	0597983	MERCEDES BUS	16-20
6194605205	0506578	MERCEDES	7-15	6283200289	0587982	MERCEDES BUS	16-20
6194605305	0507804	MERCEDES	7-15	6283200389	0587983	MERCEDES BUS	16-20
619687	0186960	VOLVO	11-16	6283201089	0597980	MERCEDES BUS	16-20
6203300003	0507593	MERCEDES	7-6	6283201189	0587980	MERCEDES BUS	16-20
6203300503	0507593	MERCEDES	7-6	6283201389	0587981	MERCEDES BUS	16-20
6203300603	0507593	MERCEDES	7-6	6283201489	0507433	MERCEDES BUS	16-1
620350006	0807587	MERCEDES	7-36	6283300003	0507435	MERCEDES BUS	16-3
6203500106	0807587	MERCEDES	7-36	6283300103	0507435	MERCEDES BUS	16-3
6204600005	0506575	MERCEDES	7-18	6283330003	0807416	MERCEDES BUS	16-14
6204600105	0507805	MERCEDES	7-18	6283330005	0807413	MERCEDES BUS	16-13
6204602005	0506575	MERCEDES	7-18	6283330205	0807591	MERCEDES BUS	16-13
6204602105	0507805	MERCEDES	7-18	6283330305	0807592	MERCEDES BUS	16-14
6204602405	0507670	MERCEDES	7-21	6283330405	0807593	MERCEDES BUS	16-12
6204602605	0507670	MERCEDES	7-21	6283331005	0807413	MERCEDES BUS	16-13
6204602805	0506575	MERCEDES	7-18	6283331805	0807413	MERCEDES BUS	16-13
6204602905	0507590	MERCEDES	7-16	6284600205	0507432	MERCEDES BUS	16-7
6204603005	0507590	MERCEDES	7-16	6284600305	0507430	MERCEDES BUS	16-5
6204603705	0506575	MERCEDES	7-18	6284601105	0507432	MERCEDES BUS	16-7
6204603805	0507805	MERCEDES	7-18	6284601205	0507430	MERCEDES BUS	16-5
6204603905	0507805	MERCEDES	7-18	6293200189	0507433	MERCEDES BUS	16-1
6204604005	0507670	MERCEDES	7-21	6293500006	0807411	MERCEDES BUS	16-15
6204604105	0507670	MERCEDES	7-21	6293500105	0807411	MERCEDES BUS	16-15
6224600205	0507698	MERCEDES	7-10	6293500106	0807412	MERCEDES BUS	16-12
6224600305	0507698	MERCEDES	7-10	6293500506	0807590	MERCEDES BUS	16-13
6224600905	0507698	MERCEDES	7-10	6293500606	0807590	MERCEDES BUS	16-13
6224601005	0507698	MERCEDES	7-10	6293501106	0807411	MERCEDES BUS	16-15
6243500006	0807611	MERCEDES	7-31	6293501206	0807412	MERCEDES BUS	16-12
6243500106	0807616	MERCEDES	7-32	6293502806	0807412	MERCEDES BUS	16-12
6243500206	0807829	MERCEDES	7-43	6293520005	0807420	MERCEDES BUS	16-14
6243500306	0807613	MERCEDES	7-43	6313200028	0402159	MERCEDES	7-50
6243500406	0807830	MERCEDES	7-43	6313200028	0402159	MERCEDES BUS	16-19
6243500506	0807618	MERCEDES	7-43	6313200028	0402159	VEICOLI COMMERCIALI - LCV VEHICLE	1-37
6244600348	0287313	MERCEDES	7-25	6313200128	0402159	MERCEDES	7-50
6253300119	0927440	MERCEDES	7-54	6313200128	0402159	MERCEDES BUS	16-19
6253300219	0927441	MERCEDES	7-54	6313200228	0402159	MERCEDES	7-50
6253300903	0507910	MERCEDES	7-2	6313200228	0402159	MERCEDES BUS	16-19
6253301203	0507910	MERCEDES	7-2	6313200228	0402159	VEICOLI COMMERCIALI - LCV VEHICLE	1-37
6253301503	0507591	MERCEDES	7-4	6313300303	0502258	VEICOLI COMMERCIALI - LCV VEHICLE	1-36
6253301603	0507591	MERCEDES	7-4	6313300435	0192260	VEICOLI COMMERCIALI - LCV VEHICLE	1-37
6253302403	0507591	MERCEDES	7-4	6313300503	0502260	VEICOLI COMMERCIALI - LCV VEHICLE	1-36
6253302503	0507591	MERCEDES	7-4	6313300535	0182259	VEICOLI COMMERCIALI - LCV VEHICLE	1-36
6253303203	0507437	MERCEDES	7-3	6313300603	0502259	MERCEDES BUS	16-1
6254601405	0507700	MERCEDES	7-24	6313300603	0502259	VEICOLI COMMERCIALI - LCV VEHICLE	1-36
6254602505	0507640	MERCEDES	7-17				
6254604005	0507700	MERCEDES	7-24				
6254604205	0507694	MERCEDES	7-24				
6254605005	0507628	MERCEDES	7-23				
6254607805	0507694	MERCEDES	7-24				



Cross Reference Guide

RIF. ORIG O.E. NUMBER	RIF. OCAP REF. OCAP	MARCA	PAG.	RIF. ORIG O.E. NUMBER	RIF. OCAP REF. OCAP	MARCA	PAG.
6313300703	0502260	VEICOLI COMMERCIALI - LCV VEHICLE	1-36	6394600048	0294249	VEICOLI COMMERCIALI - LCV VEHICLE	1-53
6313380310	0182261	VEICOLI COMMERCIALI - LCV VEHICLE	1-36	6394600055	0604250-K	VEICOLI COMMERCIALI - LCV VEHICLE	1-53
6313380410	0192258	VEICOLI COMMERCIALI - LCV VEHICLE	1-36	6394600348	0284249	VEICOLI COMMERCIALI - LCV VEHICLE	1-53
6313380510	0182260	MERCEDES BUS	16-8	6394600548	0284249	VEICOLI COMMERCIALI - LCV VEHICLE	1-53
6314600705	0502261	VEICOLI COMMERCIALI - LCV VEHICLE	1-37	6474600005	0506962	MERCEDES	7-15
6323200232	0507433	MERCEDES BUS	16-1	6474600105	0506962	MERCEDES	7-15
6323200532	0507433	MERCEDES BUS	16-1	6474600205	0507671	MERCEDES	7-15
6323500306	0807416	MERCEDES BUS	16-14	6474600305	0507671	MERCEDES	7-15
634300120	0287752	RENAULT V.I.	9-14	6517356	1215878	VEICOLI COMMERCIALI - LCV VEHICLE	1-25
634300130	0297752	RENAULT V.I.	9-14	6517364	0281725	VEICOLI COMMERCIALI - LCV VEHICLE	1-24
6344600505	0507424	MERCEDES BUS	16-1	6523500306	0807585	MERCEDES	7-30
6383230268	0591907	VEICOLI COMMERCIALI - LCV VEHICLE	1-52	6533500005	0807218	MERCEDES	7-41
6383230368	0581907	VEICOLI COMMERCIALI - LCV VEHICLE	1-52	6533500006	0807642	MERCEDES	7-30
6383230468	0594163	VEICOLI COMMERCIALI - LCV VEHICLE	1-52	6533500105	0807218	MERCEDES	7-41
6383230568	0584163	VEICOLI COMMERCIALI - LCV VEHICLE	1-52	6533500106	0807585	MERCEDES	7-30
6383260116	0504160	VEICOLI COMMERCIALI - LCV VEHICLE	1-52	6533500205	0807619	MERCEDES	7-40
6383300010	0791906	VEICOLI COMMERCIALI - LCV VEHICLE	1-52	653500006	0807586	MERCEDES	7-34
6383300110	0781906	VEICOLI COMMERCIALI - LCV VEHICLE	1-51	653503506	0807616	MERCEDES	7-32
6383330027	0401906	VEICOLI COMMERCIALI - LCV VEHICLE	1-51	6543500005	0807867	MERCEDES	7-41
6384600048	0281904	MERCEDES BUS	16-8	6543500105	0807867	MERCEDES	7-41
6384600048	0281904	VEICOLI COMMERCIALI - LCV VEHICLE	1-51	6543500305	0807867	MERCEDES	7-41
6384600205	0501904	VEICOLI COMMERCIALI - LCV VEHICLE	1-51	6553500006	0807586	MERCEDES	7-34
6384600255	0601905	VEICOLI COMMERCIALI - LCV VEHICLE	1-51	6553500305	0807218	MERCEDES	7-41
638680	0197523	SCANIA	10-13	656085	0287229	DAF-LEYLAND DAF	3-22
638861	0907531	SCANIA	10-13	6563500005	0807619	MERCEDES	7-40
638862	0907259	SCANIA	10-11	6583500005	0807218	MERCEDES	7-41
638869	0187759	SCANIA	10-13	6583500006	0807586	MERCEDES	7-34
638870	0907761	SCANIA	10-11	6583500105	0807619	MERCEDES	7-40
638938	0907773	SCANIA	10-14	6583500205	0807619	MERCEDES	7-40
639287	0907259	SCANIA	10-11	6583500206	0807586	MERCEDES	7-34
639288	0907773	SCANIA	10-14	6593500106	0807643	MERCEDES	7-33
639299	0907759	SCANIA	10-13	6593500124	0807605	MERCEDES	7-32
639319	0907405	SCANIA	10-16	6593500406	0807617	MERCEDES	7-33
639319	0907405	SCANIA BUS	19-5	6593500427	0807615	MERCEDES	7-32
6393200089	0594262	VEICOLI COMMERCIALI - LCV VEHICLE	1-54	6593500906	0807831	MERCEDES	7-44
6393200189	0584262	VEICOLI COMMERCIALI - LCV VEHICLE	1-54	6593501006	0807618	MERCEDES	7-43
6393300410	0794260	VEICOLI COMMERCIALI - LCV VEHICLE	1-53	6593501106	0807611	MERCEDES	7-31
6393300510	0784260	VEICOLI COMMERCIALI - LCV VEHICLE	1-53	6593501206	0807616	MERCEDES	7-32
6393330214	1215704	VEICOLI COMMERCIALI - LCV VEHICLE	1-54	6593501306	0807829	MERCEDES	7-43
639340	0907623	MERCEDES	7-49	6593501406	0807613	MERCEDES	7-43
639361	0197751	SCANIA	10-12	6593501506	0807830	MERCEDES	7-43
639362	0187772	SCANIA	10-12	6593501606	0807618	MERCEDES	7-43
639370	0907528	SCANIA	10-11	6593502206	0807604	MERCEDES	7-44
639370	0907528	SCANIA BUS	19-4	6593502406	0807643	MERCEDES	7-33
				6593502706	0807617	MERCEDES	7-33
				6593503206	0807831	MERCEDES	7-44
				6593503306	0807618	MERCEDES	7-43
				6593503406	0807611	MERCEDES	7-31
				6593503506	0807616	MERCEDES	7-32
				6593503606	0807829	MERCEDES	7-43
				6593503706	0807613	MERCEDES	7-43
				6593503806	0807830	MERCEDES	7-43
				6593503906	0807618	MERCEDES	7-43

RIF. ORIG O.E. NUMBER	RIF. OCAP REF. OCAP	MARCA	PAG.	RIF. ORIG O.E. NUMBER	RIF. OCAP REF. OCAP	MARCA	PAG.
6593504506	0807604	MERCEDES	7-44	6687191	0281725	VEICOLI COMMERCIALI - LCV VEHICLE	1-24
6608818	1215877	VEICOLI COMMERCIALI - LCV VEHICLE	1-25	6693300403	0507653	VEICOLI COMMERCIALI - LCV VEHICLE	1-47
6608830	0782751	VEICOLI COMMERCIALI - LCV VEHICLE	1-24	6693300503	0507653	VEICOLI COMMERCIALI - LCV VEHICLE	1-47
6608832	0792751	VEICOLI COMMERCIALI - LCV VEHICLE	1-25	6703300003	0507653	MERCEDES	7-3
6643307211	0807417	MERCEDES BUS	16-14	6703300003	0507653	VEICOLI COMMERCIALI - LCV VEHICLE	1-47
6653307411	0807417	MERCEDES BUS	16-14	6703300103	0507653	MERCEDES	7-3
6673300303	0501499	VEICOLI COMMERCIALI - LCV VEHICLE	1-47	6703300103	0507653	VEICOLI COMMERCIALI - LCV VEHICLE	1-47
6673300403	0501499	VEICOLI COMMERCIALI - LCV VEHICLE	1-47	6703300119	0927419	MERCEDES	7-53
6673300503	0501499	VEICOLI COMMERCIALI - LCV VEHICLE	1-47	6703300203	0507653	MERCEDES	7-3
6673300603	0501499	MERCEDES	7-3	6703300203	0507653	MERCEDES BUS	16-2
6673300603	0501499	VEICOLI COMMERCIALI - LCV VEHICLE	1-47	6703300203	0507653	VEICOLI COMMERCIALI - LCV VEHICLE	1-47
6674600705	0507831	VEICOLI COMMERCIALI - LCV VEHICLE	1-47	6703300219	0927420	MERCEDES	7-53
6674601005	0507831	VEICOLI COMMERCIALI - LCV VEHICLE	1-47	6703300303	0507653	MERCEDES	7-3
6674601505	0507905	VEICOLI COMMERCIALI - LCV VEHICLE	1-49	6703300303	0507653	MERCEDES BUS	16-2
6674601605	0507608	MERCEDES	7-9	6703300303	0507653	VEICOLI COMMERCIALI - LCV VEHICLE	1-47
6674601605	0507608	VEICOLI COMMERCIALI - LCV VEHICLE	1-49	6703300403	0507653	MERCEDES	7-3
6674601705	0507905	VEICOLI COMMERCIALI - LCV VEHICLE	1-49	6703300503	0507653	MERCEDES	7-3
6674601805	0507608	MERCEDES	7-9	6704600805	0507830	VEICOLI COMMERCIALI - LCV VEHICLE	1-46
6674601805	0507608	VEICOLI COMMERCIALI - LCV VEHICLE	1-49	6704600905	0507898	MERCEDES	7-9
6683300019	0927416	MERCEDES	7-52	6704600905	0507898	MERCEDES BUS	16-4
6684600505	0507660	MERCEDES	7-9	6704600905	0507898	VEICOLI COMMERCIALI - LCV VEHICLE	1-47
6684600505	0507660	VEICOLI COMMERCIALI - LCV VEHICLE	1-46	6704601205	0507830	VEICOLI COMMERCIALI - LCV VEHICLE	1-46
6684600705	0507660	MERCEDES	7-9	6704601605	0507830	VEICOLI COMMERCIALI - LCV VEHICLE	1-46
6684600705	0507660	VEICOLI COMMERCIALI - LCV VEHICLE	1-46	6704601805	0507898	MERCEDES	7-9
6684600905	0507660	MERCEDES	7-9	6704601805	0507898	MERCEDES BUS	16-4
6684600905	0507660	VEICOLI COMMERCIALI - LCV VEHICLE	1-46	6704601805	0507898	VEICOLI COMMERCIALI - LCV VEHICLE	1-47
6684601105	0507660	MERCEDES	7-9	6704602005	0507830	VEICOLI COMMERCIALI - LCV VEHICLE	1-46
6684601105	0507660	VEICOLI COMMERCIALI - LCV VEHICLE	1-46	6704602205	0507898	MERCEDES	7-9
6684601505	0507656	VEICOLI COMMERCIALI - LCV VEHICLE	1-46	6704602205	0507898	MERCEDES BUS	16-4
6684601705	0507656	MERCEDES	7-9	6704602205	0507898	VEICOLI COMMERCIALI - LCV VEHICLE	1-47
6684601705	0507656	VEICOLI COMMERCIALI - LCV VEHICLE	1-46	6704602605	0507659	MERCEDES	7-8
6684601905	0507656	MERCEDES	7-9	6704602605	0507659	MERCEDES BUS	16-4
6684601905	0507656	VEICOLI COMMERCIALI - LCV VEHICLE	1-46	6704602605	0507659	VEICOLI COMMERCIALI - LCV VEHICLE	1-45
6684602105	0507960	MERCEDES	7-9	6704602705	0507659	MERCEDES	7-8
6684602105	0507960	VEICOLI COMMERCIALI - LCV VEHICLE	1-45	6704602705	0507659	MERCEDES BUS	16-4
6684602205	0507960	MERCEDES	7-9	6704602705	0507659	VEICOLI COMMERCIALI - LCV VEHICLE	1-45
6684602205	0507960	VEICOLI COMMERCIALI - LCV VEHICLE	1-45	6704602805	0507624	MERCEDES	7-8
6684602305	0507826	MERCEDES	7-8	6704602805	0507624	MERCEDES BUS	16-4
6684602305	0507826	VEICOLI COMMERCIALI - LCV VEHICLE	1-45	6704602805	0507624	VEICOLI COMMERCIALI - LCV VEHICLE	1-45
6684602405	0507826	MERCEDES	7-8	6704602905	0507624	MERCEDES	7-8
6684602405	0507826	VEICOLI COMMERCIALI - LCV VEHICLE	1-45	6704602905	0507624	MERCEDES BUS	16-4
				6704602905	0507624	VEICOLI COMMERCIALI - LCV VEHICLE	1-45
				6713300003	0507619	MERCEDES BUS	16-3
				6713330005	0807822	MERCEDES BUS	16-15
				6713330105	0807594	MERCEDES BUS	16-12
				6714600005	0507422	MERCEDES BUS	16-6

Cross Reference Guide

RIF. ORIG O.E. NUMBER	RIF. OCAP REF. OCAP	MARCA	PAG.	RIF. ORIG O.E. NUMBER	RIF. OCAP REF. OCAP	MARCA	PAG.
6714600105	0507426	MERCEDES BUS	16-5	6764600105	0506577	MERCEDES BUS	16-5
6714600205	0507422	MERCEDES BUS	16-6	6764600205	0507701	MERCEDES	7-13
6714600305	0507426	MERCEDES BUS	16-5	6764600605	0506577	MERCEDES	7-12
67303	0296428	DAF-LEYLAND DAF	3-10	6764600605	0506577	MERCEDES BUS	16-5
673300503	0507792	MERCEDES BUS	16-2	6764600705	0507701	MERCEDES	7-13
6734600205	0506583	MERCEDES	7-11	6764601105	0506577	MERCEDES	7-12
6734600305	0507828	MERCEDES	7-11	6764601105	0506577	MERCEDES BUS	16-5
6734600405	0506583	MERCEDES	7-11	6764601205	0507701	MERCEDES	7-13
6734600505	0507828	MERCEDES	7-11	6764601505	0506577	MERCEDES	7-12
6734600605	0506583	MERCEDES	7-11	6764601505	0506577	MERCEDES BUS	16-5
6734600705	0507828	MERCEDES	7-11	6764601605	0507701	MERCEDES	7-13
6734600805	0506583	MERCEDES	7-11	6764601905	0507639	MERCEDES	7-13
6734600905	0507828	MERCEDES	7-11	6764602105	0507639	MERCEDES	7-13
67389	0286428	DAF-LEYLAND DAF	3-10	6764603105	0507794	MERCEDES	7-13
6753300019	0927420	MERCEDES	7-53	6771112	0507707	VOLVO	11-12
6753300119	0927419	MERCEDES	7-53	6771120	0507715	VOLVO	11-12
6754601005	0506576	MERCEDES	7-12	67711200	0507715	VOLVO	11-12
6754601005	0506576	MERCEDES BUS	16-5	6773300303	0506586	MERCEDES	7-2
6754601205	0506581	MERCEDES	7-11	6773300403	0506586	MERCEDES	7-2
6754601205	0506581	MERCEDES BUS	16-5	6777705	0807770	VOLVO	11-17
6754601405	0507787	MERCEDES	7-12	6777855	0507116	VOLVO	11-12
6754601605	0506576	MERCEDES	7-12	6790473	0507717	VOLVO	11-9
6754601605	0506576	MERCEDES BUS	16-5	6790474	0507681	VOLVO	11-9
6754601805	0506581	MERCEDES	7-11	6790572	0507115	VOLVO	11-10
6754601805	0506581	MERCEDES BUS	16-5	67905729	0507115	VOLVO	11-10
6754602005	0507787	MERCEDES	7-12	6790607	0507802	VOLVO	11-10
6754602205	0506576	MERCEDES	7-12	67906073	0507802	VOLVO	11-10
6754602205	0506576	MERCEDES BUS	16-5	6790766	0507802	VOLVO	11-10
6754602405	0506581	MERCEDES	7-11	6791948	0507116	VOLVO	11-12
6754602405	0506581	MERCEDES BUS	16-5	6797979	0807770	VOLVO	11-17
6754602605	0507787	MERCEDES	7-12	6799189	0507121	VOLVO	11-10
6754602805	0506576	MERCEDES	7-12	67991893	0507121	VOLVO	11-10
6754602805	0506576	MERCEDES BUS	16-5	6799190	0509902	VOLVO	11-11
6754603005	0506581	MERCEDES	7-11	680374	0927402	DAF-LEYLAND DAF	3-23
6754603005	0506581	MERCEDES BUS	16-5	681511	0927404	DAF-LEYLAND DAF	3-24
6754603205	0507787	MERCEDES	7-12	681621	0927402	DAF-LEYLAND DAF	3-23
6754603305	0506581	MERCEDES	7-11	681706	0927403	DAF-LEYLAND DAF	3-23
6763300103	0507788	MERCEDES	7-2	6851475000	0186598	MERCEDES BUS	16-10
6763300203	0507790	MERCEDES	7-2	6851476000	0196598	MERCEDES BUS	16-10
6763300203	0507790	MERCEDES BUS	16-2	6851478000	0187146	MERCEDES BUS	16-10
6763300303	0507792	MERCEDES	7-1	6851481000	0196598	MERCEDES BUS	16-10
6763300303	0507792	MERCEDES BUS	16-2	6851484000	0186598	MERCEDES BUS	16-10
6763300403	0507790	MERCEDES	7-2	6851485000	0196598	MERCEDES BUS	16-10
6763300403	0507790	MERCEDES BUS	16-2	6851486000	0187146	MERCEDES BUS	16-10
6763300503	0507792	MERCEDES	7-1	6851488000	0197146	MERCEDES BUS	16-10
6763300603	0507790	MERCEDES	7-2	6851516000	0186424	MERCEDES BUS	16-9
6763300603	0507790	MERCEDES BUS	16-2	6851523000	0197146	MERCEDES BUS	16-10
6763300703	0507790	MERCEDES	7-2	6851529000	0287881	MERCEDES BUS	16-9
6763300703	0507790	MERCEDES BUS	16-2	68515290000	0287881	MERCEDES BUS	16-9
6763300803	0507792	MERCEDES	7-1	6851531000	0186598	MERCEDES BUS	16-10
6763300803	0507792	MERCEDES BUS	16-2	6851532000	0197146	MERCEDES BUS	16-10
6763300903	0507790	MERCEDES	7-2	6851533000	0187146	MERCEDES BUS	16-10
6763300903	0507790	MERCEDES BUS	16-2	6852195	0507769	VOLVO	11-11
6763301003	0507792	MERCEDES	7-1	6852196	0507768	VOLVO	11-11
6763301003	0507792	MERCEDES BUS	16-2	6852197	0507710	VOLVO	11-11
6763301103	0507788	MERCEDES	7-2	6853511	0507709	VOLVO	11-1
6763301203	0507788	MERCEDES	7-2	6853913	0187228	VOLVO	11-26
6764600105	0506577	MERCEDES	7-12	6862225	0507708	VOLVO	11-2

Cross Reference Guide

RIF. ORIG O.E. NUMBER	RIF. OCAP REF. OCAP	MARCA	PAG.	RIF. ORIG O.E. NUMBER	RIF. OCAP REF. OCAP	MARCA	PAG.
6866174	0507713	VOLVO	11-4	701419803E	0591411	VEICOLI COMMERCIALI - LCV VEHICLE	1-98
6866175	0507714	VOLVO	11-4				
6869744	0196960	VOLVO	11-16	701419804C	0581405	VEICOLI COMMERCIALI - LCV VEHICLE	1-95
6869744	0196960	VOLVO BUS	20-4				
6869950	1211165	VEICOLI COMMERCIALI - LCV VEHICLE	1-24	701419804D	0581407	VEICOLI COMMERCIALI - LCV VEHICLE	1-95
68699511	0601726	VEICOLI COMMERCIALI - LCV VEHICLE	1-24	701419804E	0581411	VEICOLI COMMERCIALI - LCV VEHICLE	1-98
6876948	0507712	VOLVO	11-9	701419804F	0581413	VEICOLI COMMERCIALI - LCV VEHICLE	1-98
6882111	0186960	VOLVO	11-16				
6882112	0196960	VOLVO	11-16	701419811A	0291405	VEICOLI COMMERCIALI - LCV VEHICLE	1-95
6883300003	0507653	VEICOLI COMMERCIALI - LCV VEHICLE	1-47				
				701419811B	0291407	VEICOLI COMMERCIALI - LCV VEHICLE	1-96
6883300103	0507653	VEICOLI COMMERCIALI - LCV VEHICLE	1-47				
				701419811C	0291411	VEICOLI COMMERCIALI - LCV VEHICLE	1-98
6884001	0196959	VOLVO	11-15				
				701419811E	0291413	VEICOLI COMMERCIALI - LCV VEHICLE	1-99
6889509	0907359	VOLVO	11-17				
691709	0907359	VOLVO	11-17	701419812	0281405	VEICOLI COMMERCIALI - LCV VEHICLE	1-95
696321	0907686	DAF-LEYLAND DAF	3-21				
698609	0186424	DAF-LEYLAND DAF	3-9	701419812A	0281407	VEICOLI COMMERCIALI - LCV VEHICLE	1-96
698609	0186424	DAF BUS	13-1				
6994601648	0186442	MERCEDES	7-28	701419812B	0281411	VEICOLI COMMERCIALI - LCV VEHICLE	1-98
6994602405	0507694	MERCEDES	7-24				
6994603705	0507700	MERCEDES	7-24	701419812D	0281413	VEICOLI COMMERCIALI - LCV VEHICLE	1-99
6994603905	0507700	MERCEDES	7-24				
6994604005	0507700	MERCEDES	7-24	701501131	1215662	VEICOLI COMMERCIALI - LCV VEHICLE	1-97
6C113A052BB	0783867	VEICOLI COMMERCIALI - LCV VEHICLE	1-27				
				702419803A	0591406	VEICOLI COMMERCIALI - LCV VEHICLE	1-95
6C113A053BB	0793867	VEICOLI COMMERCIALI - LCV VEHICLE	1-27				
				702419803B	0591407	VEICOLI COMMERCIALI - LCV VEHICLE	1-95
6K13312	0289929	DAF-LEYLAND DAF	3-12				
				702419803C	0591412	VEICOLI COMMERCIALI - LCV VEHICLE	1-98
6K13313	0299929	DAF-LEYLAND DAF	3-12				
				702419803D	0591413	VEICOLI COMMERCIALI - LCV VEHICLE	1-99
6.851.488.000	0187342	MERCEDES BUS	16-9				
				702419804A	0581406	VEICOLI COMMERCIALI - LCV VEHICLE	1-95
6.851.489.000	0197342	MERCEDES BUS	16-9				
				702419804B	0581407	VEICOLI COMMERCIALI - LCV VEHICLE	1-95
6.851.490.000	0197467	MERCEDES	7-28				
				702419804C	0581412	VEICOLI COMMERCIALI - LCV VEHICLE	1-98
6.851.490.000	0197467	MERCEDES BUS	16-11				
6.851.491.000	0187467	MERCEDES BUS	16-10	7136367	0507155	FIAT - OM	4-4
701407077A	1215660	VEICOLI COMMERCIALI - LCV VEHICLE	1-96				
				7166166	0506904	IVECO TRUCK	5-1
701407087	1215659	VEICOLI COMMERCIALI - LCV VEHICLE	1-94				
				7166384	0506542	IVECO TRUCK	5-1
701407140B	1215663	VEICOLI COMMERCIALI - LCV VEHICLE	1-97				
				7167757	0186608	IVECO TRUCK	5-18
701407140C	1215663	VEICOLI COMMERCIALI - LCV VEHICLE	1-97				
				71737047	0391184	VEICOLI COMMERCIALI - LCV VEHICLE	1-7
701407183C	1215661	VEICOLI COMMERCIALI - LCV VEHICLE	1-96				
				71737048	0381184	VEICOLI COMMERCIALI - LCV VEHICLE	1-7
701407187A	0401409	VEICOLI COMMERCIALI - LCV VEHICLE	1-96				
				7420399543	0509894	VOLVO	11-3
701407187B	0401409	VEICOLI COMMERCIALI - LCV VEHICLE	1-96				
				7420547286	0907919	RENAULT V.I.	9-20
701407361B	0401410	VEICOLI COMMERCIALI - LCV VEHICLE	1-96				
				7420581086	0509914	VOLVO	11-2
701411041	1214105	VEICOLI COMMERCIALI - LCV VEHICLE	1-97				
				7420713859	0509910	RENAULT V.I.	9-2
701411041D	1214270	VEICOLI COMMERCIALI - LCV VEHICLE	1-97				
				7420741703	0807913	RENAULT V.I.	9-19
701411049	0501443	VEICOLI COMMERCIALI - LCV VEHICLE	1-97				
				7420741710	0907913	RENAULT V.I.	9-19
701411049B	0503864	VEICOLI COMMERCIALI - LCV VEHICLE	1-97				
				7420829503	0807762	RENAULT V.I.	9-20
701419803C	0591405	VEICOLI COMMERCIALI - LCV VEHICLE	1-95				
				7420840815	0907763	RENAULT V.I.	9-20
701419803D	0591407	VEICOLI COMMERCIALI - LCV VEHICLE	1-95				
				7421295227	0807762	RENAULT V.I.	9-20
				7422163637	0509911	RENAULT V.I.	9-2
				7485114029	0287291	RENAULT V.I.	9-11
				7485114932	0507755	RENAULT V.I.	9-5
				7485114938	0507985	RENAULT V.I.	9-7
				7567284	0400096	IVECO TRUCK	5-34
				7567284	0400096	VEICOLI COMMERCIALI - LCV VEHICLE	1-12



Cross Reference Guide

RIF. ORIG O.E. NUMBER	RIF. OCAP REF. OCAP	MARCA	PAG.	RIF. ORIG O.E. NUMBER	RIF. OCAP REF. OCAP	MARCA	PAG.
7695185	0380565	VEICOLI COMMERCIALI - LCV VEHICLE	1-12	7701470364	0281495	VEICOLI COMMERCIALI - LCV VEHICLE	1-55
7695186	0390565	VEICOLI COMMERCIALI - LCV VEHICLE	1-12	7701473333	0604424-K	VEICOLI COMMERCIALI - LCV VEHICLE	1-61
7695190	0380406	VEICOLI COMMERCIALI - LCV VEHICLE	1-12	7701473334	0903807	VEICOLI COMMERCIALI - LCV VEHICLE	1-61
7695191	0390406	VEICOLI COMMERCIALI - LCV VEHICLE	1-12	7701473334 *	1211589	VEICOLI COMMERCIALI - LCV VEHICLE	1-61
7700302122	1215609	VEICOLI COMMERCIALI - LCV VEHICLE	1-56	7701477385	0404627	VEICOLI COMMERCIALI - LCV VEHICLE	1-62
7700302123	1215610	VEICOLI COMMERCIALI - LCV VEHICLE	1-56	77362278	0282323	VEICOLI COMMERCIALI - LCV VEHICLE	1-1
7700302165	0593812	VEICOLI COMMERCIALI - LCV VEHICLE	1-56	77362279	0283815	VEICOLI COMMERCIALI - LCV VEHICLE	1-20
7700307343	0583812	VEICOLI COMMERCIALI - LCV VEHICLE	1-56	77364009	0282637	VEICOLI COMMERCIALI - LCV VEHICLE	1-5
7700309070	0593812	VEICOLI COMMERCIALI - LCV VEHICLE	1-56	77364253	0292637	VEICOLI COMMERCIALI - LCV VEHICLE	1-5
7700309071	0583812	VEICOLI COMMERCIALI - LCV VEHICLE	1-56	77364254	0902637	VEICOLI COMMERCIALI - LCV VEHICLE	1-5
7700309189	0391494	VEICOLI COMMERCIALI - LCV VEHICLE	1-55	7981909	0187228	IVECO BUS	14-11
7700309190	0381494	VEICOLI COMMERCIALI - LCV VEHICLE	1-55	7984276	0196612	IVECO TRUCK	5-17
7700312851	0401522	VEICOLI COMMERCIALI - LCV VEHICLE	1-55	7D0407140	1215663	VEICOLI COMMERCIALI - LCV VEHICLE	1-97
7700312852	0401494	VEICOLI COMMERCIALI - LCV VEHICLE	1-55	7D0407140A	1215663	VEICOLI COMMERCIALI - LCV VEHICLE	1-97
7700680852	1211128	VEICOLI COMMERCIALI - LCV VEHICLE	1-81	7D0407183	1215661	VEICOLI COMMERCIALI - LCV VEHICLE	1-96
7700706007	1211123	VEICOLI COMMERCIALI - LCV VEHICLE	1-82	7D0407361	0401425	VEICOLI COMMERCIALI - LCV VEHICLE	1-99
7700774566	1211267	VEICOLI COMMERCIALI - LCV VEHICLE	1-81	7D0411045	1214109	VEICOLI COMMERCIALI - LCV VEHICLE	1-97
7701002911	0187146	RENAULT V.I.	9-14	7D0411049	0501443	VEICOLI COMMERCIALI - LCV VEHICLE	1-97
7701011267	0907216	RENAULT V.I.	9-21	7D1411041	1214276	VEICOLI COMMERCIALI - LCV VEHICLE	1-97
7701011412	0186598	RENAULT V.I.	9-13	7H0407151E	0392723	VEICOLI COMMERCIALI - LCV VEHICLE	1-102
7701011412	0186598	RENAULT V.I. BUS	18-3	7H0407151F	0392723	VEICOLI COMMERCIALI - LCV VEHICLE	1-102
7701013272	0181401	VEICOLI COMMERCIALI - LCV VEHICLE	1-88	7H0407151G	0392723	VEICOLI COMMERCIALI - LCV VEHICLE	1-102
7701013276	0191401	VEICOLI COMMERCIALI - LCV VEHICLE	1-88	7H0407152E	0382723	VEICOLI COMMERCIALI - LCV VEHICLE	1-102
7701016946	0186424	RENAULT V.I.	9-12	7H0407152F	0382723	VEICOLI COMMERCIALI - LCV VEHICLE	1-102
7701016946	0186424	RENAULT V.I. BUS	18-3	7H0407152G	0382723	VEICOLI COMMERCIALI - LCV VEHICLE	1-102
7701049282	0293875	VEICOLI COMMERCIALI - LCV VEHICLE	1-61	7H0407182A	1215872	VEICOLI COMMERCIALI - LCV VEHICLE	1-102
7701049283	0283875	VEICOLI COMMERCIALI - LCV VEHICLE	1-61	7H0407183	1215873	VEICOLI COMMERCIALI - LCV VEHICLE	1-102
7701461667	0402235	VEICOLI COMMERCIALI - LCV VEHICLE	1-82	7H0407361	0404336	VEICOLI COMMERCIALI - LCV VEHICLE	1-101
7701461770	0180947	VEICOLI COMMERCIALI - LCV VEHICLE	1-81	7H0419803D	0594333	VEICOLI COMMERCIALI - LCV VEHICLE	1-101
7701462427	0282240	VEICOLI COMMERCIALI - LCV VEHICLE	1-76	7H0419803E	0594333	VEICOLI COMMERCIALI - LCV VEHICLE	1-101
7701462692	0402241	VEICOLI COMMERCIALI - LCV VEHICLE	1-76	7H0419804D	0584333	VEICOLI COMMERCIALI - LCV VEHICLE	1-101
7701462693	0402242	VEICOLI COMMERCIALI - LCV VEHICLE	1-76	7H0419804E	0584333	VEICOLI COMMERCIALI - LCV VEHICLE	1-101
7701462987	0502231	VEICOLI COMMERCIALI - LCV VEHICLE	1-81	7H0422817A	0294333	VEICOLI COMMERCIALI - LCV VEHICLE	1-101
7701463035	0502230	VEICOLI COMMERCIALI - LCV VEHICLE	1-81	7H0422817B	0294333	VEICOLI COMMERCIALI - LCV VEHICLE	1-101
7701470361	1211392	VEICOLI COMMERCIALI - LCV VEHICLE	1-59	7H0422817C	0294333	VEICOLI COMMERCIALI - LCV VEHICLE	1-101
7701470362	0601496-K	VEICOLI COMMERCIALI - LCV VEHICLE	1-77				
7701470363	0291495	VEICOLI COMMERCIALI - LCV VEHICLE	1-55				

Cross Reference Guide

RIF. ORIG O.E. NUMBER	RIF. OCAP REF. OCAP	MARCA	PAG.	RIF. ORIG O.E. NUMBER	RIF. OCAP REF. OCAP	MARCA	PAG.
7H0422817D	0294333	VEICOLI COMMERCIALI - LCV VEHICLE	1-101	81432206082	0807818	MAN	6-22
7H0422818A	0284333	VEICOLI COMMERCIALI - LCV VEHICLE	1-101	81432206083	0807818	MAN	6-22
7H0422818B	0284333	VEICOLI COMMERCIALI - LCV VEHICLE	1-101	81432206084	0807818	MAN	6-22
7H0422818C	0284333	VEICOLI COMMERCIALI - LCV VEHICLE	1-101	81432206090	0807811	MAN	6-16
7H0422818D	0284333	VEICOLI COMMERCIALI - LCV VEHICLE	1-101	81432206091	0807833	MAN	6-17
7H0422831	1211430	VEICOLI COMMERCIALI - LCV VEHICLE	1-101	81432206092	0807811	MAN	6-16
7H5411317	0504337	VEICOLI COMMERCIALI - LCV VEHICLE	1-102	81432206093	0807833	MAN	6-17
7H5411317A	0504337	VEICOLI COMMERCIALI - LCV VEHICLE	1-102	81432206096	0807559	MAN	6-16
7H8407361	0404335	VEICOLI COMMERCIALI - LCV VEHICLE	1-101	81432206097	0807559	MAN	6-16
7H8407361A	0404335	VEICOLI COMMERCIALI - LCV VEHICLE	1-101	81432206098	0807559	MAN	6-16
80003406	0506893	IVECO TRUCK	5-10	81432206099	0807822	MAN BUS	15-10
80003408	0506893	IVECO TRUCK	5-10	81432206100	0807822	MAN BUS	15-10
80003410	0507321	IVECO TRUCK	5-8	81432206103	0807822	MAN BUS	15-10
8073569	0809907	VOLVO	11-21	81432206104	0907259	MAN	6-15
8122752	0186598	IVECO BUS	14-4	81432206104	0907259	MAN BUS	15-8
8122754	0186424	IVECO TRUCK	5-18	81432206106	0807818	MAN	6-22
8122755	0196424	IVECO TRUCK	5-18	81432206107	0907259	MAN	6-15
8123326	0196608	DAF-LEYLAND DAF	3-8	81432206107	0907259	MAN BUS	15-8
8123394	0196613	IVECO TRUCK	5-17	81432206108	0907258	DAF-LEYLAND DAF	3-14
8131582	0506931	IVECO BUS	14-2	81432206108	0907258	MAN	6-16
8131582	0506931	IVECO TRUCK	5-12	81432206112	0807409	MAN BUS	15-9
8132373	0507683	VOLVO	11-12	81432206113	0807822	MAN BUS	15-10
8132397	0506931	IVECO BUS	14-2	81432206114	0807822	MAN BUS	15-10
8132397	0506931	IVECO TRUCK	5-12	81432206123	0807409	MAN BUS	15-9
8135446	0506897	IVECO TRUCK	5-8	81432206125	0807409	MAN BUS	15-9
8135492	0507287	IVECO TRUCK	5-7	81432206127	0807409	MAN BUS	15-9
8136061	0506927	IVECO TRUCK	5-5	81432206129	0807559	MAN	6-16
8137026	0807211	IVECO TRUCK	5-28	81432206132	0907258	DAF-LEYLAND DAF	3-14
8137027	0807358	IVECO TRUCK	5-22	81432206132	0907258	IVECO TRUCK	5-22
8137594	0507860	IVECO TRUCK	5-4	81432206132	0907258	MAN	6-16
8138182	0506932	IVECO TRUCK	5-4	81432206137	0807559	MAN	6-16
814304	0186601	FIAT - OM	4-5	81432206140	0807824	MAN	6-17
814305	0196601	FIAT - OM	4-5	81432206140	0807824	MAN	6-17
81432206010	0807214	MAN	6-15	81432206143	0807822	MAN BUS	15-10
81432206012	0807214	MAN	6-15	81432206144	0807408	MAN BUS	15-9
81432206013	0807214	MAN	6-15	81432206145	0807808	MAN BUS	15-8
81432206020	0807214	MAN	6-15	81432206145	0807808	NEOPLAN BUS	17-9
81432206035	0807214	MAN	6-15	81432206147	0807818	MAN	6-22
81432206040	0807214	MAN	6-15	81432206151	0807823	MAN BUS	15-8
81432206041	0807214	MAN	6-15	81432206151	0807823	NEOPLAN BUS	17-10
81432206052	0807214	MAN	6-15	81432206160	0807808	MAN BUS	15-8
81432206055	0907259	MAN	6-15	81432206161	0807821	MAN	6-15
81432206055	0907259	MAN BUS	15-8	81432206161	0807821	MAN BUS	15-8
81432206056	0807214	MAN	6-15	81432206161	0807821	NEOPLAN BUS	17-10
81432206067	0807811	MAN	6-16	81432206162	0807808	MAN BUS	15-8
81432206068	0807811	MAN	6-16	81432206164	0807806	MAN BUS	15-8
81432206070	0807833	MAN	6-17	81432206165	0807806	MAN BUS	15-8
81432206071	0807833	MAN	6-17	81432206166	0807806	MAN BUS	15-8
81432206072	0807833	MAN	6-17	81432206173	0807822	MAN BUS	15-10
81432206073	0907259	MAN	6-15	81432206174	0807807	MAN	6-20
81432206073	0907259	MAN BUS	15-8	81432206177	0807816	MAN BUS	15-8
				81432206177	0807816	NEOPLAN BUS	17-8
				81432206179	0807816	MAN BUS	15-8
				81432206183	0807823	MAN BUS	15-8
				81432206183	0807823	NEOPLAN BUS	17-10
				81432206185	0807822	MAN BUS	15-10
				81432206187	0807410	MAN BUS	15-9
				81432206189	0807408	MAN BUS	15-9
				81432206189	0807408	NEOPLAN BUS	17-9

**Cross Reference Guide**

<b>RIF. ORIG O.E. NUMBER</b>	<b>RIF. OCAP REF. OCAP</b>	<b>MARCA</b>	<b>PAG.</b>	<b>RIF. ORIG O.E. NUMBER</b>	<b>RIF. OCAP REF. OCAP</b>	<b>MARCA</b>	<b>PAG.</b>
81432206190	0807821	MAN	6-15	81432206409	0807408	MAN BUS	15-9
81432206190	0807821	MAN BUS	15-8	81432206409	0807408	NEOPLAN BUS	17-9
81432206190	0807821	NEOPLAN BUS	17-10	81432209092	0807811	MAN	6-16
81432206196	0807906	MAN	6-17	81432209129	0807559	MAN	6-16
81432206202	0907405	MAN	6-24	81432209140	0807824	MAN	6-17
81432206204	0907409	MAN BUS	15-9	81432209236	0807407	MAN	6-16
81432206208	0807808	MAN BUS	15-8	81432209267	0807407	MAN	6-16
81432206209	0807808	MAN BUS	15-8	81432209272	0807407	MAN	6-16
81432206210	0807408	MAN BUS	15-9	81432306014	0807559	MAN	6-16
81432206211	0807408	MAN BUS	15-9	81432306018	0807214	MAN	6-15
81432206213	0807801	MAN	6-21	81432306028	0807214	MAN	6-15
81432206215	0807806	MAN BUS	15-8	81432306030	0807559	MAN	6-16
81432206215	0807806	NEOPLAN BUS	17-9	81432306037	0807216	MAN	6-15
81432206220	0807409	MAN BUS	15-9	81432306038	0807810	MAN	6-22
81432206221	0807840	MAN	6-19	81432306039	0807810	MAN	6-22
81432206222	0807817	MAN	6-22	81432306043	0907216	MAN	6-15
81432206224	0807816	MAN BUS	15-8	81432306049	0807818	MAN	6-22
81432206227	0807806	MAN BUS	15-8	81432306051	0907528	MAN	6-22
81432206228	0807806	MAN BUS	15-8	81432306051	0907528	MAN BUS	15-11
81432206232	0807906	MAN	6-17	81432306068	0907528	MAN	6-22
81432206234	0807410	MAN BUS	15-9	81432309037	0807216	MAN	6-15
81432206236	0807407	MAN	6-16	81432309039	0807810	MAN	6-22
81432206240	0807410	MAN BUS	15-9	81432506009	0907770	MAN	6-24
81432206241	0907919	MAN	6-17	81432706030	0807533	MAN	6-18
81432206247	0807820	MAN	6-15	81432706034	0807533	MAN	6-18
81432206248	0807819	MAN BUS	15-8	81432706040	0907330	MAN	6-24
81432206250	0907362	NEOPLAN BUS	17-10	81432706040	0907330	MAN BUS	15-11
81432206250	0907906	MAN	6-17	81432706045	0907330	MAN	6-24
81432206251	0807819	MAN BUS	15-8	81432706045	0907330	MAN BUS	15-11
81432206254	0807819	MAN BUS	15-8	81432706053	0807846	MAN	6-21
81432206256	0807819	MAN BUS	15-8	81432706054	0807533	MAN	6-18
81432206258	0807832	MAN BUS	15-9	81432706055	0807533	MAN	6-18
81432206258	0807832	NEOPLAN BUS	17-10	81432706056	0807847	MAN	6-21
81432206260	0807817	MAN	6-22	81432706057	0807533	MAN	6-18
81432206264	0807832	MAN BUS	15-9	81432706065	0907406	MAN	6-21
81432206264	0807832	NEOPLAN BUS	17-10	81432706067	0807847	MAN	6-21
81432206267	0807407	MAN	6-16	81432706068	0807847	MAN	6-21
81432206272	0807407	MAN	6-16	81432706074	0807533	MAN	6-18
81432206275	0807832	MAN BUS	15-9	81432706075	0807847	MAN	6-21
81432206275	0807832	NEOPLAN BUS	17-10	81432706076	0807533	MAN	6-18
81432206276	0807823	MAN BUS	15-8	81432706077	0807847	MAN	6-21
81432206276	0807823	NEOPLAN BUS	17-10	81432706078	0807533	MAN	6-18
81432206278	0807832	MAN BUS	15-9	81432706079	0907686	MAN	6-21
81432206278	0807832	NEOPLAN BUS	17-10	81432706080	0907683	MAN	6-25
81432206279	0807832	MAN BUS	15-9	81432706081	0807847	MAN	6-21
81432206279	0807832	NEOPLAN BUS	17-10	81432706087	0807839	MAN	6-19
81432206283	0807817	MAN	6-22	81432706088	0807839	MAN	6-19
81432206284	0807817	MAN	6-22	81432706091	0907846	MAN	6-22
81432206304	0807407	MAN	6-16	81432706094	0807839	MAN	6-19
81432206305	0807407	MAN	6-16	81432706095	0807839	MAN	6-19
81432206322	0907820	MAN	6-15	81432706096	0807840	MAN	6-19
81432206341	0807820	MAN	6-15	81432706097	0807842	MAN	6-20
81432206342	0807820	MAN	6-15	81432706105	0907907	MAN	6-18
81432206369	0907362	NEOPLAN BUS	17-10	81432706110	0907774	IVECO TRUCK	5-25
81432206382	0807407	MAN	6-16	81432706110	0907774	MAN	6-19
81432206396	0807408	MAN BUS	15-9	81432706113	0807842	MAN	6-20
81432206396	0807408	NEOPLAN BUS	17-9	81432706114	0807840	MAN	6-19
81432206401	0807407	MAN	6-16	81432706116	0807841	MAN	6-20

**Cross Reference Guide**

<b>RIF. ORIG O.E. NUMBER</b>	<b>RIF. OCAP REF. OCAP</b>	<b>MARCA</b>	<b>PAG.</b>	<b>RIF. ORIG O.E. NUMBER</b>	<b>RIF. OCAP REF. OCAP</b>	<b>MARCA</b>	<b>PAG.</b>
81432706117	0807907	MAN	6-18	81466106578	0507823	MAN	6-5
81432706118	0907840	MAN	6-19	81466106579	0507848	MAN	6-2
81432706119	0907919	MAN	6-17	81466106579	0507848	MAN BUS	15-2
81432706121	0807840	MAN	6-19	81466106580	0507848	MAN	6-2
81432706123	0907840	MAN	6-19	81466106580	0507848	MAN BUS	15-2
81432706126	0907840	MAN	6-19	81466106583	0507848	MAN	6-2
81432706127	0907362	MAN BUS	15-9	81466106583	0507848	MAN BUS	15-2
81432706133	0907845	MAN BUS	15-10	81466106598	0507823	MAN	6-5
81432706133	0907845	NEOPLAN BUS	17-11	81466106603	0507810	MAN	6-10
81432706135	0807842	MAN	6-20	81466106606	0507212	MAN BUS	15-5
81432706137	0807841	MAN	6-20	81466106624	0507848	MAN	6-2
81432706150	0807841	MAN	6-20	81466106624	0507848	MAN BUS	15-2
81432706151	0807841	MAN	6-20	81466106640	0507848	MAN	6-2
81432706160	0807842	MAN	6-20	81466106640	0507848	MAN BUS	15-2
81432706161	0807842	MAN	6-20	81466106648	0507204	MAN BUS	15-5
81432709053	0807846	MAN	6-21	81466106656	0507406	MAN	6-10
81432709054	0807533	MAN	6-18	81466106659	0507406	MAN	6-10
81432709056	0807847	MAN	6-21	81466106669	0507406	MAN	6-10
81432709078	0807533	MAN	6-18	81466106684	0507685	MAN BUS	15-5
81433150009	0907844	MAN BUS	15-10	81466106692	0507815	MAN	6-8
81433150009	0907844	NEOPLAN BUS	17-10	81466106693	0507815	MAN	6-8
81433156036	0807844	MAN BUS	15-10	81466106695	0507815	MAN	6-8
81433156036	0807844	NEOPLAN BUS	17-10	81466106706	0507549	MAN BUS	15-4
81433156037	0807844	MAN BUS	15-10	81466106708	0509920	MAN BUS	15-4
81433156037	0807844	NEOPLAN BUS	17-10	81466106711	0507809	MAN BUS	15-4
81466106001	0506446	MAN	6-6	81466106721	0506443	MAN	6-9
81466106004	0507839	MAN	6-6	81466106722	0506443	MAN	6-9
81466106006	0507839	MAN	6-6	81466106723	0506443	MAN	6-9
81466106088	0506445	MAN	6-5	81466106724	0506446	MAN	6-6
81466106159	0507958	MAN	6-5	81466106725	0506446	MAN	6-6
81466106160	0507821	MAN	6-7	81466106753	0507839	MAN	6-6
81466106167	0507844	MAN	6-6	81466106754	0507839	MAN	6-6
81466106200	0507958	MAN	6-5	81466106779	0507822	MAN	6-10
81466106241	0507214	MAN	6-8	81466106780	0507822	MAN	6-10
81466106275	0507958	MAN	6-5	81466106782	0507822	MAN	6-10
81466106280	0506444	MAN	6-6	81466106785	0507809	MAN BUS	15-4
81466106281	0506436	MAN	6-5	81466106790	0507820	MAN	6-10
81466106288	0506445	MAN	6-5	81466106791	0507820	MAN	6-10
81466106300	0506436	MAN	6-5	81466106794	0507952	MAN BUS	15-5
81466106301	0507818	MAN	6-5	81466106794	0507952	NEOPLAN BUS	17-4
81466106303	0506436	MAN	6-5	81466106795	0507791	MAN BUS	15-4
81466106304	0506436	MAN	6-5	81466106798	0507823	MAN	6-5
81466106305	0507818	MAN	6-5	81466106807	0507917	MAN	6-9
81466106305	0507818	MAN BUS	15-4	81466106808	0507917	MAN	6-9
81466106317	0507958	MAN	6-5	81466106809	0507408	MAN	6-8
81466106327	0506436	MAN	6-5	81466106810	0507408	MAN	6-8
81466106328	0507818	MAN	6-5	81466106811	0507951	MAN	6-9
81466106329	0506436	MAN	6-5	81466106812	0507951	MAN	6-9
81466106333	0506443	MAN	6-9	81466106823	0507408	MAN	6-8
81466106334	0506443	MAN	6-9	81466106836	0507917	MAN	6-9
81466106354	0506443	MAN	6-9	81466106838	0507408	MAN	6-8
81466106355	0506443	MAN	6-9	81466106839	0507408	MAN	6-8
81466106360	0506443	MAN	6-9	81466106840	0507951	MAN	6-9
81466106361	0506443	MAN	6-9	81466106876	0507823	MAN	6-5
81466106374	0507955	MAN	6-9	81466116003	0507409	MAN	6-10
81466106374	0507955	MAN BUS	15-4	81466116004	0507409	MAN	6-10
81466106375	0507685	MAN BUS	15-5	81466116005	0507409	MAN	6-10
81466106414	0507214	MAN	6-8	81466116006	0507406	MAN	6-10

**Cross Reference Guide**

<b>RIF. ORIG O.E. NUMBER</b>	<b>RIF. OCAP REF. OCAP</b>	<b>MARCA</b>	<b>PAG.</b>	<b>RIF. ORIG O.E. NUMBER</b>	<b>RIF. OCAP REF. OCAP</b>	<b>MARCA</b>	<b>PAG.</b>
81466116016	0507685	MAN BUS	15-5	81467106137	0507806	MAN BUS	15-1
81466116017	0507549	MAN BUS	15-4	81467106162	0507833	MAN	6-2
81466116019	0507955	MAN	6-9	81467106163	0507807	MAN	6-4
81466116019	0507955	MAN BUS	15-4	81467106164	0507833	MAN	6-2
81466116043	0507809	MAN BUS	15-4	81467106165	0507807	MAN	6-4
81466116044	0507952	MAN BUS	15-5	81467106167	0507807	MAN	6-4
81466116044	0507952	NEOPLAN BUS	17-4	81467106172	0507950	MAN BUS	15-1
81466116045	0507791	MAN BUS	15-4	81467106173	0507806	MAN BUS	15-1
81466116045	0507791	NEOPLAN BUS	17-3	81467106189	0507833	MAN	6-2
81466116047	0507791	MAN BUS	15-4	81467106194	0507817	MAN	6-2
81466116049	0507791	MAN BUS	15-4	81467106195	0507817	MAN	6-2
81466116064	0507958	MAN	6-5	81467106198	0507807	MAN	6-4
81466116067	0509920	MAN BUS	15-4	81467106236	0507835	MAN	6-4
81466116081	0507809	MAN BUS	15-4	81467106238	0507816	MAN	6-1
81466116085	0507952	MAN BUS	15-5	81467106240	0507816	MAN	6-1
81466116085	0507952	NEOPLAN BUS	17-4	81467106242	0507816	MAN	6-1
81466116096	0507917	MAN	6-9	81467106265	0507808	MAN	6-3
81466116097	0507917	MAN	6-9	81467106266	0507808	MAN	6-3
81466116099	0507917	MAN	6-9	81467106267	0507835	MAN	6-4
81466116104	0507408	MAN	6-8	81467106268	0507835	MAN	6-4
81466116105	0507408	MAN	6-8	81467106280	0507958	MAN	6-5
81466116107	0507408	MAN	6-8	81467106294	0507806	MAN BUS	15-1
81466116108	0507952	MAN BUS	15-5	81467106295	0507950	MAN BUS	15-1
81466116108	0507952	NEOPLAN BUS	17-4	81467106313	0507958	MAN	6-5
81466116114	0507952	MAN BUS	15-5	81467106314	0507534	MAN	6-2
81466116114	0507952	NEOPLAN BUS	17-4	81467106314	0507534	MAN BUS	15-2
81466116115	0507791	MAN BUS	15-4	81467106315	0507534	MAN	6-2
81466116120	0507952	MAN BUS	15-5	81467106315	0507534	MAN BUS	15-2
81466116120	0507952	NEOPLAN BUS	17-4	81467106316	0507534	MAN	6-2
81466116126	0507791	MAN BUS	15-4	81467106316	0507534	MAN BUS	15-2
81466116132	0507917	MAN	6-9	81467106319	0507958	MAN	6-5
81466116133	0507917	MAN	6-9	81467106325	0507832	MAN	6-1
81466116134	0507408	MAN	6-8	81467106337	0507950	MAN BUS	15-1
81466116135	0507408	MAN	6-8	81467106345	0507950	MAN BUS	15-1
81466116136	0507917	MAN	6-9	81467106353	0507807	MAN	6-4
81466116137	0507408	MAN	6-8	81467106354	0507807	MAN	6-4
81466116138	0507951	MAN	6-9	81467106355	0507835	MAN	6-4
81466116139	0507951	MAN	6-9	81467106356	0507835	MAN	6-4
81466116145	0507951	MAN	6-9	81467106359	0507808	MAN	6-3
81466116150	0507204	MAN BUS	15-5	81467106360	0507808	MAN	6-3
81466116197	0507917	MAN	6-9	81467106361	0507807	MAN	6-4
81466116198	0507917	MAN	6-9	81467106362	0507808	MAN	6-3
81466116199	0507408	MAN	6-8	81467106368	0507833	MAN	6-2
81466116200	0507408	MAN	6-8	81467106369	0507833	MAN	6-2
81466116201	0507951	MAN	6-9	81467106373	0507835	MAN	6-4
81466116202	0507951	MAN	6-9	81467106378	0507817	MAN	6-2
81466116203	0507951	MAN	6-9	81467106379	0507817	MAN	6-2
81466116205	0507917	MAN	6-9	81467106380	0507817	MAN	6-2
81466116206	0507408	MAN	6-8	81467106388	0507847	MAN	6-2
81466116217	0507410	MAN BUS	15-5	81467106390	0507847	MAN	6-2
81467106080	0507950	MAN BUS	15-1	81467106393	0507847	MAN	6-2
81467106081	0507806	MAN BUS	15-1	81467106394	0507833	MAN	6-2
81467106086	0507832	MAN	6-1	81467106395	0507840	MAN	6-3
81467106112	0507807	MAN	6-4	81467106395	0507840	MAN BUS	15-2
81467106118	0507833	MAN	6-2	81467106396	0507808	MAN	6-3
81467106122	0507817	MAN	6-2	81467106397	0507808	MAN	6-3
81467106131	0507808	MAN	6-3	81467106409	0507816	MAN	6-1
81467106136	0507950	MAN BUS	15-1	81467106410	0507816	MAN	6-1



**Cross Reference Guide**

<b>RIF. ORIG O.E. NUMBER</b>	<b>RIF. OCAP REF. OCAP</b>	<b>MARCA</b>	<b>PAG.</b>	<b>RIF. ORIG O.E. NUMBER</b>	<b>RIF. OCAP REF. OCAP</b>	<b>MARCA</b>	<b>PAG.</b>
81467106411	0507816	MAN	6-1	81467116717	0507841	MAN	6-3
81467106419	0507806	MAN BUS	15-1	81467116719	0507840	MAN	6-3
81467106421	0507950	MAN BUS	15-1	81467116719	0507840	MAN BUS	15-2
81467106434	0507819	MAN	6-1	81467116720	0507848	MAN	6-2
81467106435	0507819	MAN	6-1	81467116720	0507848	MAN BUS	15-2
81467106436	0507216	MAN	6-8	81467116722	0507811	MAN BUS	15-2
81467106437	0507216	MAN	6-8	81467116723	0507835	MAN	6-4
81467106438	0507845	MAN	6-1	81467116724	0507808	MAN	6-3
81467106439	0507845	MAN	6-1	81467116725	0507807	MAN	6-4
81467106442	0507846	MAN	6-1	81467116726	0507581	MAN	6-4
81467106443	0507846	MAN	6-1	81467116728	0507841	MAN	6-3
81467106444	0507806	MAN BUS	15-1	81467116743	0507405	MAN	6-1
81467106451	0507950	MAN BUS	15-1	81467116744	0507405	MAN	6-1
81467106453	0507407	MAN BUS	15-1	81467116759	0507806	MAN BUS	15-1
81467106455	0507216	MAN	6-8	81467116762	0507950	MAN BUS	15-1
81467106457	0507407	MAN BUS	15-1	81467116765	0507407	MAN BUS	15-1
81467106458	0507407	MAN BUS	15-1	81467116766	0507407	MAN BUS	15-1
81467106459	0507742	MAN BUS	15-3	81467116767	0507407	MAN BUS	15-1
81467106460	0507846	MAN	6-1	81467116770	0507743	MAN BUS	15-1
81467106806	0507742	MAN BUS	15-3	81467116770	0507743	NEOPLAN BUS	17-1
81467106816	0507808	MAN	6-3	81467116771	0507957	MAN BUS	15-1
81467106818	0507742	MAN BUS	15-3	81467116772	0507743	MAN BUS	15-1
81467106819	0507742	MAN BUS	15-3	81467116772	0507743	NEOPLAN BUS	17-1
81467106830	0507817	MAN	6-2	81467116773	0507915	MAN	6-4
81467106833	0507833	MAN	6-2	81467116780	0507957	MAN BUS	15-1
81467106836	0507817	MAN	6-2	81467116803	0507814	MAN	6-3
81467106849	0507807	MAN	6-4	81467116810	0507405	MAN	6-1
81467106851	0507840	MAN	6-3	81467116820	0507807	MAN	6-4
81467106851	0507840	MAN BUS	15-2	81467116845	0507824	MAN BUS	15-2
81467106852	0507840	MAN	6-3	81467116848	0507915	MAN	6-4
81467106852	0507840	MAN BUS	15-2	81467116858	0507915	MAN	6-4
81467106862	0507824	MAN BUS	15-2	81467116859	0507915	MAN	6-4
81467106863	0507824	MAN BUS	15-2	81467116860	0507915	MAN	6-4
81467106864	0507824	MAN BUS	15-2	81467116861	0507915	MAN	6-4
81467106865	0507841	MAN	6-3	81467116862	0507915	MAN	6-4
81467106866	0507841	MAN	6-3	81467116863	0507915	MAN	6-4
81467106875	0507407	MAN BUS	15-1	81467116874	0507743	MAN BUS	15-1
81467106876	0507950	MAN BUS	15-1	81467116874	0507743	NEOPLAN BUS	17-1
81467106877	0507806	MAN BUS	15-1	81467116875	0507743	MAN BUS	15-1
81467106879	0507806	MAN BUS	15-1	81467116875	0507743	NEOPLAN BUS	17-1
81467106881	0507407	MAN BUS	15-1	81467116876	0507743	MAN BUS	15-1
81467106902	0507811	MAN BUS	15-2	81467116876	0507743	NEOPLAN BUS	17-1
81467106904	0507808	MAN	6-3	81467116877	0507957	MAN BUS	15-1
81467106908	0507742	MAN BUS	15-3	81467116878	0507957	MAN BUS	15-1
81467106909	0507824	MAN BUS	15-2	81467116879	0507957	MAN BUS	15-1
81467106910	0507824	MAN BUS	15-2	81467116882	0507915	MAN	6-4
81467106912	0507817	MAN	6-2	81467116883	0507915	MAN	6-4
81467106912	0507817	MAN BUS	15-2	81467116884	0507405	MAN	6-1
81467106926	0507405	MAN	6-1	81467116885	0507405	MAN	6-1
81467106933	0507843	MAN	6-3	81467116886	0507954	MAN BUS	15-1
81467106934	0507843	MAN	6-3	81467116886	0507954	NEOPLAN BUS	17-1
81467106937	0507833	MAN	6-2	81467116888	0507915	MAN	6-4
81467106974	0507824	MAN BUS	15-2	81467116893	0507814	MAN	6-3
81467106994	0507581	MAN	6-4	81467116894	0507814	MAN	6-3
81467107001	0507832	MAN	6-1	81467116896	0507814	MAN	6-3
81467116711	0507843	MAN	6-3	81467116897	0507954	MAN BUS	15-1
81467116712	0507824	MAN BUS	15-2	81467116897	0507954	NEOPLAN BUS	17-1
81467116715	0507894	MAN BUS	15-3	81467116898	0507954	MAN BUS	15-1

**Cross Reference Guide**

<b>RIF. ORIG O.E. NUMBER</b>	<b>RIF. OCAP REF. OCAP</b>	<b>MARCA</b>	<b>PAG.</b>	<b>RIF. ORIG O.E. NUMBER</b>	<b>RIF. OCAP REF. OCAP</b>	<b>MARCA</b>	<b>PAG.</b>
81467116898	0507954	NEOPLAN BUS	17-1	81953016043	0196598	MAN	6-13
81467116899	0507954	MAN BUS	15-1	81953016043	0196598	MAN BUS	15-6
81467116899	0507954	NEOPLAN BUS	17-1	81953016048	0186598	MAN	6-12
81467116920	0507915	MAN	6-4	81953016048	0186598	MAN BUS	15-6
81467116921	0507915	MAN	6-4	81953016049	0186598	MAN	6-12
81467116930	0507915	MAN	6-4	81953016049	0186598	MAN BUS	15-6
81467116972	0507957	MAN BUS	15-1	81953016050	0196598	MAN	6-13
814671406367	0507847	MAN	6-2	81953016050	0196598	MAN BUS	15-6
8151876	0287458	VOLVO	11-14	81953016053	0186598	MAN	6-12
8154016	0807762	VOLVO	11-20	81953016053	0186598	MAN BUS	15-6
8154017	0807687	VOLVO	11-19	81953016054	0196598	MAN	6-13
8154018	0807687	VOLVO	11-19	81953016054	0196598	MAN BUS	15-6
8156123	0509900	VOLVO	11-2	81953016060	0186613	MAN	6-11
8156123	0509900	VOLVO BUS	20-1	81953016063	0297229	MAN	6-26
8158206	0807687	VOLVO	11-19	81953016063	0297229	MAN BUS	15-12
8158207	0807687	VOLVO	11-19	81953016064	0287229	MAN	6-26
8163773	0506932	IVECO TRUCK	5-4	81953016064	0287229	MAN BUS	15-12
8165309	0507288	IVECO TRUCK	5-4	81953016067	0186424	MAN	6-12
8166702	0507371	IVECO TRUCK	5-15	81953016067	0186424	MAN BUS	15-6
81767106879	0507807	MAN	6-4	81953016068	0196424	MAN	6-12
8190225	0196598	IVECO TRUCK	5-18	81953016068	0196424	MAN BUS	15-6
8193645	0186613	IVECO TRUCK	5-17	81953016070	0197146	MAN	6-13
8193646	0196613	IVECO TRUCK	5-17	81953016071	0287684	MAN	6-11
8193649	0196595	IVECO TRUCK	5-17	81953016087	0196598	MAN	6-13
81953010013	0196424	MAN	6-12	81953016087	0196598	MAN BUS	15-6
81953010013	0196424	MAN BUS	15-6	81953016090	0186598	MAN	6-12
81953010014	0186424	MAN	6-12	81953016090	0186598	MAN BUS	15-6
81953010014	0186424	MAN BUS	15-6	81953016091	0196598	MAN	6-13
81953010015	0196598	MAN	6-13	81953016091	0196598	MAN BUS	15-6
81953010015	0196598	MAN BUS	15-6	81953016092	0187349	MAN	6-14
81953010016	0186598	MAN	6-12	81953016093	0197523	MAN	6-14
81953010016	0186598	MAN BUS	15-6	81953016095	0287684	MAN	6-11
81953010022	0186758	MAN	6-13	81953016096	0187838	MAN	6-11
81953010022	0186758	MAN BUS	15-7	81953016106	0287684	MAN	6-11
81953010022	0186758	NEOPLAN BUS	17-7	81953016107	0196598	MAN	6-13
81953010022	0186758	SCANIA	10-9	81953016107	0196598	MAN BUS	15-6
81953010025	0187146	MAN	6-13	81953016108	0186598	MAN	6-12
81953010038	0187228	MAN	6-26	81953016108	0186598	MAN BUS	15-6
81953010038	0187228	MAN BUS	15-12	81953016112	0186598	MAN	6-12
81953010045	0187228	MAN	6-26	81953016112	0186598	MAN BUS	15-6
81953010064	0186424	MAN	6-12	81953016120	0196598	MAN	6-13
81953010064	0186424	MAN BUS	15-6	81953016120	0196598	MAN BUS	15-6
81953010067	0186424	MAN	6-12	81953016125	0196598	MAN	6-13
81953010074	0196424	MAN	6-12	81953016125	0196598	MAN BUS	15-6
81953010074	0196424	MAN BUS	15-6	81953016126	0186598	MAN	6-12
81953010077	0186595	MAN	6-11	81953016126	0186598	MAN BUS	15-6
81953010078	0196595	MAN	6-11	81953016130	0287229	MAN	6-26
81953010079	0196613	MAN	6-12	81953016130	0287229	MAN BUS	15-12
81953010082	0196424	MAN	6-12	81953016131	0297229	MAN	6-26
81953010084	0186598	MAN	6-12	81953016131	0297229	MAN BUS	15-12
81953010084	0186598	MAN BUS	15-6	81953016132	0907533	MAN	6-18
81953010087	0196598	MAN	6-13	81953016133	0907534	MAN	6-18
81953010087	0196598	MAN BUS	15-6	81953016134	0186595	MAN	6-11
81953010089	0187410	MAN BUS	15-7	81953016135	0186613	MAN	6-11
81953010091	0187463	MAN	6-13	81953016139	0196613	MAN	6-12
81953016016	0187228	MAN	6-26	81953016140	0186613	MAN	6-11
81953016030	0196598	MAN	6-13	81953016141	0196595	MAN	6-11
81953016030	0196598	MAN BUS	15-6	81953016142	0186595	MAN	6-11

Cross Reference Guide

RIF. ORIG O.E. NUMBER	RIF. OCAP REF. OCAP	MARCA	PAG.	RIF. ORIG O.E. NUMBER	RIF. OCAP REF. OCAP	MARCA	PAG.
81953016143	0186598	MAN	6-12	81953016242	0186598	MAN	6-12
81953016143	0186598	MAN BUS	15-6	81953016242	0186598	MAN BUS	15-6
81953016149	0186598	MAN	6-12	81953016246	0186424	MAN	6-12
81953016149	0186598	MAN BUS	15-6	81953016249	0186613	MAN	6-11
81953016152	0196598	MAN	6-13	81953016250	0186424	MAN	6-12
81953016152	0196598	MAN BUS	15-6	81953016250	0186424	MAN BUS	15-6
81953016154	0186598	MAN	6-12	81953016255	0287907	MAN BUS	15-7
81953016154	0186598	MAN BUS	15-6	81953016261	0197146	MAN	6-13
81953016155	0196598	MAN	6-13	81953016263	0186442	MAN	6-14
81953016155	0196598	MAN BUS	15-6	81953016266	0187228	MAN	6-26
81953016156	0186598	MAN	6-12	81953016266	0187228	MAN BUS	15-12
81953016156	0186598	MAN BUS	15-6	81953016267	0287906	MAN	6-11
81953016157	0196598	MAN	6-13	81953016268	0289923	DAF-LEYLAND DAF	3-8
81953016157	0196598	MAN BUS	15-6	81953016268	0289923	IVECO TRUCK	5-16
81953016162	0186424	MAN	6-12	81953016268	0289923	MAN	6-11
81953016162	0186424	MAN BUS	15-6	81953016268	0289923	VOLVO	11-14
81953016163	0196424	MAN	6-12	81953016270	0187843	MAN	6-14
81953016163	0196424	MAN BUS	15-6	81953016270	0187843	MAN BUS	15-7
81953016168	0196598	MAN	6-13	81953016271	0187894	MAN	6-14
81953016168	0196598	MAN BUS	15-6	81953016271	0187894	MAN BUS	15-7
81953016169	0187228	MAN	6-26	81953016274	0186598	MAN	6-12
81953016169	0187228	MAN BUS	15-12	81953016274	0186598	MAN BUS	15-6
81953016170	0287229	MAN	6-26	81953016275	0196598	MAN	6-13
81953016170	0287229	MAN BUS	15-12	81953016275	0196598	MAN BUS	15-6
81953016171	0297229	MAN	6-26	81953016276	0186599	MAN	6-13
81953016171	0297229	MAN BUS	15-12	81953016277	0287907	MAN BUS	15-7
81953016172	0187228	MAN	6-26	81953016278	0186598	MAN	6-12
81953016172	0187228	MAN BUS	15-12	81953016278	0186598	MAN BUS	15-6
81953016173	0287229	MAN	6-26	81953016279	0196598	MAN	6-13
81953016173	0287229	MAN BUS	15-12	81953016279	0196598	MAN BUS	15-6
81953016174	0297229	MAN	6-26	81953016280	0287361	MAN	6-11
81953016174	0297229	MAN BUS	15-12	81953016281	0287360	MAN	6-11
81953016176	0187228	MAN	6-26	81953016288	0187723	MAN	6-14
81953016176	0187228	MAN BUS	15-12	81953016291	0287906	MAN	6-11
81953016178	0186598	MAN	6-12	81953016302	0187228	MAN	6-26
81953016178	0186598	MAN BUS	15-6	81953016302	0187228	MAN BUS	15-12
81953016179	0196598	MAN	6-13	81953016303	0186595	MAN	6-11
81953016179	0196598	MAN BUS	15-6	81953016304	0196595	MAN	6-11
81953016184	0186599	MAN	6-13	81953016325	0187894	MAN	6-14
81953016194	0186598	MAN	6-12	81953016325	0187894	MAN BUS	15-7
81953016194	0186598	MAN BUS	15-6	81953016337	0287360	MAN	6-11
81953016219	0287906	MAN	6-11	81953016345	0187410	MAN BUS	15-7
81953016222	0196613	MAN	6-12	81953016355	0187410	MAN BUS	15-7
81953016223	0196598	MAN	6-13	8198187	0287229	IVECO TRUCK	5-37
81953016223	0196598	MAN BUS	15-6	8198188	0297229	IVECO TRUCK	5-37
81953016224	0186598	MAN	6-12	81991648156	0807810	MAN	6-22
81953016224	0186598	MAN BUS	15-6	81998051662	0507951	MAN	6-9
81953016225	0287906	MAN	6-11	81.43270.6065	0907406	MAN	6-21
81953016226	0287906	MAN	6-11	81.44204.0008	0927406	MAN BUS	15-13
81953016233	0287907	MAN BUS	15-7	81.44205.6009	0927406	MAN	6-27
81953016234	0186598	MAN	6-12	81.44205.6009	0927406	MAN BUS	15-13
81953016234	0186598	MAN BUS	15-6	81.44205.6013	0927408	MAN	6-27
81953016235	0187228	MAN	6-26	81.44205.6013	0927408	MAN BUS	15-13
81953016235	0187228	MAN BUS	15-12	81.44205.6016	0927742	MAN	6-27
81953016237	0196598	MAN	6-13	81.95301.6288	0187723	MAN	6-14
81953016237	0196598	MAN BUS	15-6	8200002868	1215640	VEICOLI COMMERCIALI - LCV VEHICLE	1-62
81953016239	0186424	MAN	6-12				
81953016239	0186424	MAN BUS	15-6				



Cross Reference Guide

RIF. ORIG O.E. NUMBER	RIF. OCAP REF. OCAP	MARCA	PAG.	RIF. ORIG O.E. NUMBER	RIF. OCAP REF. OCAP	MARCA	PAG.
8200002869	1215641	VEICOLI COMMERCIALI - LCV VEHICLE	1-62	82467106016	0507833	MAN	6-2
8200002870	0503878	VEICOLI COMMERCIALI - LCV VEHICLE	1-63	82953010010	0287361	MAN	6-11
8200247898	0793808	VEICOLI COMMERCIALI - LCV VEHICLE	1-62	82953016016	0287360	MAN	6-11
8200247900	0783808	VEICOLI COMMERCIALI - LCV VEHICLE	1-61	82953016018	0289923	DAF-LEYLAND DAF	3-8
8200395007	0394627	VEICOLI COMMERCIALI - LCV VEHICLE	1-62	82953016018	0289923	IVECO TRUCK	5-16
8200395034	0384627	VEICOLI COMMERCIALI - LCV VEHICLE	1-62	82953016018	0289923	MAN	6-11
8200626959	0394627	VEICOLI COMMERCIALI - LCV VEHICLE	1-62	82953016018	0289923	VOLVO	11-14
8200626961	0384627	VEICOLI COMMERCIALI - LCV VEHICLE	1-62	82953016019	0289923	DAF-LEYLAND DAF	3-8
8200688832 Z	1216016	VEICOLI COMMERCIALI - LCV VEHICLE	1-60	82953016019	0289923	IVECO TRUCK	5-16
8200688871	0391536	VEICOLI COMMERCIALI - LCV VEHICLE	1-60	82953016019	0289923	MAN	6-11
8200688875	0381536	VEICOLI COMMERCIALI - LCV VEHICLE	1-59	82953016019	0289923	VOLVO	11-14
8200688877	0401536	VEICOLI COMMERCIALI - LCV VEHICLE	1-59	83466106001	0507410	MAN BUS	15-5
8200876657	0384627	VEICOLI COMMERCIALI - LCV VEHICLE	1-62	83466106501	0507410	MAN BUS	15-5
8200876659	0394627	VEICOLI COMMERCIALI - LCV VEHICLE	1-62	85104265	0509892	VOLVO BUS	20-2
8226232000	0807420	MERCEDES BUS	16-14	85114167	0509892	VOLVO BUS	20-2
8226241000	0807420	MERCEDES BUS	16-14	85115631	0509894	VOLVO	11-3
8226244000D	0507424	MERCEDES BUS	16-1	8525704	0506993	FIAT - OM	4-1
8226247000C	0507429	MERCEDES BUS	16-1	8526148	0506733	FIAT - OM	4-1
8226248000C	0507425	MERCEDES BUS	16-1	8533963	0507171	FIAT - OM	4-1
8226258000C	0507424	MERCEDES BUS	16-1	8535664	0506991	FIAT - OM	4-1
82262800000	0507427	MERCEDES BUS	16-7	85432206002	0907407	MAN	6-16
8226280000B	0507427	MERCEDES BUS	16-7	85432206002	0907407	MAN BUS	15-8
8226280000C	0507427	MERCEDES BUS	16-7	85432206002	0907407	NEOPLAN BUS	17-12
8226293000B	0807590	MERCEDES BUS	16-13	85461106141	0507217	MAN	6-5
8226306000	0507424	MERCEDES BUS	16-1	85466106005	0507217	MAN	6-5
8226308000	0507425	MERCEDES BUS	16-1	85466106007	0507559	MAN	6-7
8226308000C	0507425	MERCEDES BUS	16-1	85466106012	0507842	MAN	6-6
8226318000B	0807415	MERCEDES BUS	16-14	85466106018	0507956	MAN	6-8
8226323000B	0807415	MERCEDES BUS	16-14	85466106019	0507215	MAN	6-7
82263260000	0507423	MERCEDES BUS	16-1	85466106020	0507815	MAN	6-8
82263280000	0507423	MERCEDES BUS	16-1	85466106021	0507533	MAN	6-6
8226330000	0507421	MERCEDES BUS	16-1	85466106026	0507953	MAN	6-9
8226330000C	0507421	MERCEDES BUS	16-1	85466106030	0506446	MAN	6-6
8226347000	0507429	MERCEDES BUS	16-1	85466106031	0507839	MAN	6-6
8226355000	0507427	MERCEDES BUS	16-7	85466106102	0506446	MAN	6-6
82263550000	0507427	MERCEDES BUS	16-7	85466106104	0507839	MAN	6-6
8226357000	0807420	MERCEDES BUS	16-14	85466106105	0507217	MAN	6-5
8226380000	0507428	MERCEDES BUS	16-5	85466106107	0507559	MAN	6-7
8226380000C	0507428	MERCEDES BUS	16-5	85466106108	0507537	MAN	6-7
8226381000	0507425	MERCEDES BUS	16-1	85466106112	0507842	MAN	6-6
82466106080	0507955	MAN	6-9	85466106118	0507956	MAN	6-8
82466106080	0507955	MAN BUS	15-4	85466106119	0507215	MAN	6-7
82466106189	0507955	MAN	6-9	85466106121	0507533	MAN	6-6
82466106189	0507955	MAN BUS	15-4	85466106126	0507953	MAN	6-9
82466106190	0507955	MAN	6-9	85466106140	0507533	MAN	6-6
82466106190	0507955	MAN BUS	15-4	85466106141	0507217	MAN	6-5
82466106191	0507820	MAN	6-10	85466106142	0507842	MAN	6-6
8246610691	0507820	MAN	6-10	85466106143	0507559	MAN	6-7
				85466106144	0507537	MAN	6-7
				85466106150	0507215	MAN	6-7
				85466106151	0507815	MAN	6-8
				85466106152	0507956	MAN	6-8
				85466106153	0507953	MAN	6-9
				85466106160	0507812	MAN	6-7
				85466106201	0506446	MAN	6-6
				85466106205	0507217	MAN	6-5
				85466106208	0507537	MAN	6-7
				85466106212	0507842	MAN	6-6

Cross Reference Guide

RIF. ORIG O.E. NUMBER	RIF. OCAP REF. OCAP	MARCA	PAG.	RIF. ORIG O.E. NUMBER	RIF. OCAP REF. OCAP	MARCA	PAG.
85466106218	0507956	MAN	6-8	9013200589	0502379	VEICOLI COMMERCIALI - LCV VEHICLE	1-39
85466106219	0507215	MAN	6-7				
85466106226	0507953	MAN	6-9	9013200689	0502368	VEICOLI COMMERCIALI - LCV VEHICLE	1-39
85466106230	0507839	MAN	6-6				
85466106231	0507217	MAN	6-5	9013301807	0791505	VEICOLI COMMERCIALI - LCV VEHICLE	1-39
85466106235	0507956	MAN	6-8				
85466106246	0507812	MAN	6-7	9013301907	0781505	VEICOLI COMMERCIALI - LCV VEHICLE	1-38
85466106247	0507813	MAN	6-7	9013302507	0781505	VEICOLI COMMERCIALI - LCV VEHICLE	1-38
8550139	0187228	IVECO TRUCK	5-37				
8557536	0506725	IVECO TRUCK	5-5	9013330214	1215705	VEICOLI COMMERCIALI - LCV VEHICLE	1-39
8558522	0506726	IVECO TRUCK	5-7				
8558524	0196612	IVECO TRUCK	5-17	9013330627	0401505	VEICOLI COMMERCIALI - LCV VEHICLE	1-38
8558527	0186612	IVECO TRUCK	5-17				
8558533	0186613	IVECO TRUCK	5-17	9013330727	0401505	VEICOLI COMMERCIALI - LCV VEHICLE	1-38
8558536	0196613	IVECO TRUCK	5-17				
8558540	0506728	IVECO TRUCK	5-6	9013331027	0401505	VEICOLI COMMERCIALI - LCV VEHICLE	1-38
8558541	0506728	IVECO TRUCK	5-6				
8558647	0506733	FIAT - OM	4-1	9013331127	0401505	VEICOLI COMMERCIALI - LCV VEHICLE	1-38
8558651	0506991	FIAT - OM	4-1	9013331227	0401505	VEICOLI COMMERCIALI - LCV VEHICLE	1-38
8558653	0507153	FIAT - OM	4-3	9014600048	0281503	MERCEDES BUS	16-8
8559559	0506726	IVECO TRUCK	5-7	9014600048	0281503	VEICOLI COMMERCIALI - LCV VEHICLE	1-38
8564248	0506737	IVECO TRUCK	5-6				
8564386	0507290	IVECO TRUCK	5-1	9014600148	0281503	MERCEDES BUS	16-8
8565366	0186608	IVECO TRUCK	5-18	9014600148	0281503	VEICOLI COMMERCIALI - LCV VEHICLE	1-38
8567618	0506736	IVECO TRUCK	5-6				
8567619	0506736	IVECO TRUCK	5-6	9014600155	0601504	VEICOLI COMMERCIALI - LCV VEHICLE	1-38
8570528	0506812	IVECO TRUCK	5-5				
8573757	0507164	IVECO TRUCK	5-5	9014600205	0501503	VEICOLI COMMERCIALI - LCV VEHICLE	1-38
8578492	0187234	IVECO TRUCK	5-38				
8578493	0187226	IVECO TRUCK	5-38	9014600255	0601504	VEICOLI COMMERCIALI - LCV VEHICLE	1-38
8582313	0187226	IVECO TRUCK	5-38				
8582320	0507290	IVECO TRUCK	5-1	9014600348	0281503	MERCEDES BUS	16-8
8582322	0186613	IVECO TRUCK	5-17	9014600348	0281503	VEICOLI COMMERCIALI - LCV VEHICLE	1-38
8582332	0186608	IVECO TRUCK	5-18				
8582333	0196608	IVECO TRUCK	5-18	9014600455	0601504	VEICOLI COMMERCIALI - LCV VEHICLE	1-38
8582350	0506736	IVECO TRUCK	5-6				
8590435	0506887	IVECO TRUCK	5-5	9014605500	0901504	VEICOLI COMMERCIALI - LCV VEHICLE	1-38
8591219	0506737	IVECO TRUCK	5-6				
8591222	0506726	IVECO TRUCK	5-7	9063201789	0592743	VEICOLI COMMERCIALI - LCV VEHICLE	1-41
85.43220.6002	0907407	MAN	6-16				
86011651	0506827	IVECO TRUCK	5-2	9063201889	0582743	VEICOLI COMMERCIALI - LCV VEHICLE	1-41
86012923	0506904	IVECO TRUCK	5-1				
86012924	0507323	IVECO TRUCK	5-1	9063201889	0582743	VEICOLI COMMERCIALI - LCV VEHICLE	1-41
86018015	0506827	IVECO TRUCK	5-2				
86027074	0187228	IVECO BUS	14-11	9063304007	0792742	VEICOLI COMMERCIALI - LCV VEHICLE	1-41
8788387	0506738	FIAT - OM	4-3				
8788641	0506740	FIAT - OM	4-3	9063330014	1215874	VEICOLI COMMERCIALI - LCV VEHICLE	1-41
8.226.318.000B	0807415	MERCEDES BUS	16-14				
8.226.323.000B	0807415	MERCEDES BUS	16-14	9064600048	0282717	VEICOLI COMMERCIALI - LCV VEHICLE	1-40
9009500	0506725	IVECO TRUCK	5-5				
9009501	0186614	IVECO TRUCK	5-16	9064600055	0602741-K	VEICOLI COMMERCIALI - LCV VEHICLE	1-40
9009503	0196614	IVECO TRUCK	5-17				
9013200089	0104151	VEICOLI COMMERCIALI - LCV VEHICLE	1-39	9064600096	0902741	VEICOLI COMMERCIALI - LCV VEHICLE	1-40
9013200289	0591514	VEICOLI COMMERCIALI - LCV VEHICLE	1-39				
9013200389	0581514	VEICOLI COMMERCIALI - LCV VEHICLE	1-39	90804105207	0287294	MAN	6-26
				90804105207	0287294	MAN BUS	15-12
				90804153107	0196424	MAN	6-12
				90804153107	0196424	MAN BUS	15-6
				90804153111	0186424	MAN	6-12
				90804153111	0186424	MAN BUS	15-6
				90804153113	0196424	MAN	6-12
				90804153113	0196424	MAN BUS	15-6
				90804154117	0187146	MAN	6-13
				91160038	0903807	VEICOLI COMMERCIALI - LCV VEHICLE	1-61

Cross Reference Guide

RIF. ORIG O.E. NUMBER	RIF. OCAP REF. OCAP	MARCA	PAG.	RIF. ORIG O.E. NUMBER	RIF. OCAP REF. OCAP	MARCA	PAG.
91166461	0783808	VEICOLI COMMERCIALI - LCV VEHICLE	1-61	93197233	0401536	VEICOLI COMMERCIALI - LCV VEHICLE	1-59
91166462	0793808	VEICOLI COMMERCIALI - LCV VEHICLE	1-62	93197325	0501536	VEICOLI COMMERCIALI - LCV VEHICLE	1-60
9160392	0391494	VEICOLI COMMERCIALI - LCV VEHICLE	1-55	93197332	0501496	VEICOLI COMMERCIALI - LCV VEHICLE	1-60
9160393	0381494	VEICOLI COMMERCIALI - LCV VEHICLE	1-55	93800662	0280515	IVECO TRUCK	5-16
9160394	1215609	VEICOLI COMMERCIALI - LCV VEHICLE	1-56	93802209	0280517	IVECO TRUCK	5-34
9160395	1215610	VEICOLI COMMERCIALI - LCV VEHICLE	1-56	93802209	0280517	VEICOLI COMMERCIALI - LCV VEHICLE	1-31
9160498	0593812	VEICOLI COMMERCIALI - LCV VEHICLE	1-56	93802242	0400518	IVECO TRUCK	5-35
9160499	0583812	VEICOLI COMMERCIALI - LCV VEHICLE	1-56	93802242	0400518	VEICOLI COMMERCIALI - LCV VEHICLE	1-31
9160555	0401494	VEICOLI COMMERCIALI - LCV VEHICLE	1-55	93804059	0280515	IVECO TRUCK	5-16
9161560	0903811	VEICOLI COMMERCIALI - LCV VEHICLE	1-59	93804060	0280517	IVECO TRUCK	5-34
9161560 Z	1211392	VEICOLI COMMERCIALI - LCV VEHICLE	1-59	93807545	0400518	IVECO TRUCK	5-35
9161561	0603811-K	VEICOLI COMMERCIALI - LCV VEHICLE	1-57	93807640	1215270	VEICOLI COMMERCIALI - LCV VEHICLE	1-33
9161562	0291495	VEICOLI COMMERCIALI - LCV VEHICLE	1-55	93807641	1215269	VEICOLI COMMERCIALI - LCV VEHICLE	1-33
9161563	0281495	VEICOLI COMMERCIALI - LCV VEHICLE	1-55	93810239	1215271	VEICOLI COMMERCIALI - LCV VEHICLE	1-33
9281792	0287291	IVECO TRUCK	5-17	93853465	0384627	VEICOLI COMMERCIALI - LCV VEHICLE	1-62
93157156	0287320	IVECO TRUCK	5-16	9386136	0394627	VEICOLI COMMERCIALI - LCV VEHICLE	1-62
93161371	0907578	IVECO TRUCK	5-21	93862135	0384627	VEICOLI COMMERCIALI - LCV VEHICLE	1-62
93161631	0907299	IVECO TRUCK	5-29	94038	0506430	DAF-LEYLAND DAF	3-5
93161638	0907299	IVECO TRUCK	5-29	9403817738	0282733	VEICOLI COMMERCIALI - LCV VEHICLE	1-9
93161884	0404627	VEICOLI COMMERCIALI - LCV VEHICLE	1-62	9404059080	0280037	VEICOLI COMMERCIALI - LCV VEHICLE	1-7
93161958	0907297	IVECO TRUCK	5-27	9404066838	0902733	VEICOLI COMMERCIALI - LCV VEHICLE	1-9
93161960	0907296	IVECO TRUCK	5-28	9404066838 *	1211477	VEICOLI COMMERCIALI - LCV VEHICLE	1-9
93162239	0907297	IVECO TRUCK	5-27	9413300007	0807636	MERCEDES	7-45
93162361	0907296	IVECO TRUCK	5-28	9413300011	0807671	MERCEDES	7-45
93163617	0907927	IVECO TRUCK	5-33	9413300103	0507643	MERCEDES	7-6
93165049	0807326	IVECO TRUCK	5-24	9413300203	0507643	MERCEDES	7-6
93167687	0901536	VEICOLI COMMERCIALI - LCV VEHICLE	1-59	9413300303	0507643	MERCEDES	7-6
93167687 Z	0601536	VEICOLI COMMERCIALI - LCV VEHICLE	1-59	9413300503	0507643	MERCEDES	7-6
93167688	0291536	VEICOLI COMMERCIALI - LCV VEHICLE	1-59	9423300003	0507633	MERCEDES	7-7
93167689	0281536	VEICOLI COMMERCIALI - LCV VEHICLE	1-59	9423300103	0507633	MERCEDES	7-7
93192361	0907327	IVECO BUS	14-8	9423300203	0507633	MERCEDES	7-7
93192361	0907327	IVECO TRUCK	5-22	9423300303	0507886	MERCEDES	7-6
93192618	0907304	IVECO TRUCK	5-24	9423300403	0507886	MERCEDES	7-6
93192619	0907330	IVECO TRUCK	5-21	9423300703	0507633	MERCEDES	7-7
93192809	0287238	IVECO BUS	14-4	9423300803	0507591	MERCEDES	7-4
93192809	0287238	IVECO TRUCK	5-20	9423301003	0507431	MERCEDES BUS	16-7
93194458	0907260	IVECO BUS	14-8	9423301103	0507633	MERCEDES	7-7
93194626	0186612	IVECO TRUCK	5-17	9423301603	0507886	MERCEDES	7-6
93194627	0196612	IVECO TRUCK	5-17	9423301703	0507431	MERCEDES BUS	16-7
93197214	0391536	VEICOLI COMMERCIALI - LCV VEHICLE	1-60	9423301803	0507633	MERCEDES	7-7
93197215	0381536	VEICOLI COMMERCIALI - LCV VEHICLE	1-59	9423302003	0507633	MERCEDES	7-7
93197216 Z	1216016	VEICOLI COMMERCIALI - LCV VEHICLE	1-60	9423302303	0507633	MERCEDES	7-7
93197232 Z	1216017	VEICOLI COMMERCIALI - LCV VEHICLE	1-60	9423302403	0507979	MERCEDES	7-5
				9423302503	0507431	MERCEDES BUS	16-7
				9423500105	0807984	MERCEDES	7-39
				9423500505	0807599	MERCEDES	7-38
				9423500705	0807984	MERCEDES	7-39
				9423500805	0807599	MERCEDES	7-38

**Cross Reference Guide**

<b>RIF. ORIG O.E. NUMBER</b>	<b>RIF. OCAP REF. OCAP</b>	<b>MARCA</b>	<b>PAG.</b>	<b>RIF. ORIG O.E. NUMBER</b>	<b>RIF. OCAP REF. OCAP</b>	<b>MARCA</b>	<b>PAG.</b>
9423501005	0807634	MERCEDES	7-39	9519279	0507686	VOLVO BUS	20-2
9423501105	0807984	MERCEDES	7-39	9566950880	0600918	VEICOLI COMMERCIALI - LCV VEHICLE	1-7
9423501205	0807599	MERCEDES	7-38				
9423501605	0807984	MERCEDES	7-39	9574600505	0507972	MERCEDES	7-14
94373501005	0807634	MERCEDES	7-39	9574600705	0507972	MERCEDES	7-14
9443300203	0507910	MERCEDES	7-2	9703300003	0506167	MERCEDES	7-5
9443300503	0507969	MERCEDES	7-2	9703300103	0506167	MERCEDES	7-5
9443301303	0507969	MERCEDES	7-2	9703300203	0506167	MERCEDES	7-5
9443301703	0507437	MERCEDES	7-3	9703300303	0506167	MERCEDES	7-5
9443500005	0807634	MERCEDES	7-39	9703300403	0506167	MERCEDES	7-5
9443500305	0807634	MERCEDES	7-39	9704600705	0507613	MERCEDES	7-14
9443500505	0807774	MERCEDES	7-40	9704600905	0507613	MERCEDES	7-14
9453300003	0507916	MERCEDES	7-6	97104296	0807326	IVECO TRUCK	5-24
9453300007	0807635	MERCEDES	7-45	97104299	0807328	IVECO TRUCK	5-31
9453300011	0807670	MERCEDES	7-45	9724601405	0507439	MERCEDES	7-14
9453300103	0507916	MERCEDES	7-6	9724601605	0507439	MERCEDES	7-14
9453300203	0507651	MERCEDES	7-1	9724601805	0507827	MERCEDES	7-20
9453300303	0507651	MERCEDES	7-1	9724601905	0507434	MERCEDES	7-20
9453300403	0507916	MERCEDES	7-6	9724602005	0507827	MERCEDES	7-20
9453300503	0507651	MERCEDES	7-1	9724602105	0507434	MERCEDES	7-20
9453300603	0507916	MERCEDES	7-6	9744601005	0507887	MERCEDES	7-20
9453500105	0807669	MERCEDES	7-31	9744601105	0507963	MERCEDES	7-20
94613	0507799	DAF-LEYLAND DAF	3-6	9744601205	0507887	MERCEDES	7-20
9473500005	0807634	MERCEDES	7-39	9744601305	0507963	MERCEDES	7-20
9473500105	0807634	MERCEDES	7-39	9750000280	1211064	VEICOLI COMMERCIALI - LCV VEHICLE	1-11
9473500705	0807634	MERCEDES	7-39				
9473500905	0807774	MERCEDES	7-40	9750000380	1211063	VEICOLI COMMERCIALI - LCV VEHICLE	1-11
9483500405	0807774	MERCEDES	7-40	9750079980	0280513	IVECO TRUCK	5-16
9483500605	0807669	MERCEDES	7-31	9750079980	0280513	VEICOLI COMMERCIALI - LCV VEHICLE	1-11
9483500805	0807669	MERCEDES	7-31				
9483501105	0807774	MERCEDES	7-40	9750390080	0600514	VEICOLI COMMERCIALI - LCV VEHICLE	1-11
9483501205	0807669	MERCEDES	7-31				
9483501305	0807669	MERCEDES	7-31	9753300203	0507975	MERCEDES	7-3
9483502005	0807669	MERCEDES	7-31	9753300303	0507975	MERCEDES	7-3
9483502205	0807908	MERCEDES	7-38	9753300803	0507975	MERCEDES	7-3
9483502305	0807908	MERCEDES	7-38	9753301703	0507975	MERCEDES	7-3
9483502405	0807669	MERCEDES	7-31	9753302503	0507975	MERCEDES	7-3
9483503005	0807774	MERCEDES	7-40	9790002680	0501112	VEICOLI COMMERCIALI - LCV VEHICLE	1-11
948372	0109903	VOLVO	11-25	98402544	0506951	IVECO TRUCK	5-7
948372	0109903	VOLVO BUS	20-7	98402553	0506950	IVECO TRUCK	5-2
9493300203	0507591	MERCEDES	7-4	98427667	0506817	IVECO TRUCK	5-4
9493300303	0507591	MERCEDES	7-4	98446354	0506894	IVECO TRUCK	5-10
9493300403	0507604	MERCEDES	7-6	98449025	0506956	IVECO TRUCK	5-8
9493300503	0507604	MERCEDES	7-6	98458724	0506817	IVECO TRUCK	5-4
9493300603	0507603	MERCEDES	7-6	98467459	0506951	IVECO TRUCK	5-7
9493300703	0507603	MERCEDES	7-6	98469650	0506956	IVECO TRUCK	5-8
9493300803	0507604	MERCEDES	7-6	98470968	0506994	IVECO TRUCK	5-3
9493300903	0507591	MERCEDES	7-4	98472466	0807358	IVECO TRUCK	5-22
9493301003	0507436	MERCEDES	7-3	98472468	0807296	IVECO TRUCK	5-27
9493301103	0507436	MERCEDES	7-3	98472871	0807336	IVECO TRUCK	5-22
9493301403	0507604	MERCEDES	7-6	98473328	0507850	IVECO BUS	14-2
9493301503	0507603	MERCEDES	7-6	98473328	0507850	IVECO TRUCK	5-12
9493301603	0507603	MERCEDES	7-6	98484091	0507335	IVECO TRUCK	5-36
9493301703	0507436	MERCEDES	7-3	98488010	0807209	IVECO TRUCK	5-21
9493301903	0507604	MERCEDES	7-6	98488010	0807213	IVECO BUS	14-6
9493302003	0507603	MERCEDES	7-6	98488010	0807213	IVECO TRUCK	5-21
9493302303	0507604	MERCEDES	7-6	98488013	0507335	IVECO TRUCK	5-36
9493302403	0507603	MERCEDES	7-6	98493054	0507851	IVECO TRUCK	5-9



Cross Reference Guide

RIF. ORIG O.E. NUMBER	RIF. OCAP REF. OCAP	MARCA	PAG.	RIF. ORIG O.E. NUMBER	RIF. OCAP REF. OCAP	MARCA	PAG.
99432565	0807339	IVECO BUS	14-6				
99455009	0507367	IVECO TRUCK	5-9				
9945836	0601139	VEICOLI COMMERCIALI - LCV VEHICLE	1-1				
9945837	0900449	VEICOLI COMMERCIALI - LCV VEHICLE	1-1				
99463268	0607552	VEICOLI COMMERCIALI - LCV VEHICLE	1-34				
9946982	0900489	VEICOLI COMMERCIALI - LCV VEHICLE	1-1				
9959151	0507224	VOLVO	11-1				
9959153	0507222	VOLVO	11-5				
9983325	0600516	VEICOLI COMMERCIALI - LCV VEHICLE	1-31				
A0004634429	0287361	MERCEDES	7-25				
A0004634429	0287361	MERCEDES BUS	16-8				
A0009964845	0287361	MERCEDES	7-25				
A0009964845	0287361	MERCEDES BUS	16-8				
A3574602405	0507422	MERCEDES BUS	16-6				
A3574603105	0507422	MERCEDES BUS	16-6				
A3574603205	0507426	MERCEDES BUS	16-5				
A3574603505	0507431	MERCEDES BUS	16-7				
A6273300203	0507423	MERCEDES BUS	16-1				
A6284600205	0507432	MERCEDES BUS	16-7				
A6284600305	0507430	MERCEDES BUS	16-5				
A6284601205	0507430	MERCEDES BUS	16-5				
ACU9239	0197803	DAF-LEYLAND DAF	3-13				
ACU9240	0187803	DAF-LEYLAND DAF	3-13				
ACU9241	0196613	DAF-LEYLAND DAF	3-8				
ACU9242	0186613	DAF-LEYLAND DAF	3-8				
AFRA635	0197928	DAF-LEYLAND DAF	3-10				
AFRA888	0187803	DAF-LEYLAND DAF	3-13				
BK213059A	1216246	VEICOLI COMMERCIALI - LCV VEHICLE	1-29				
BK213A262AC	1216245	VEICOLI COMMERCIALI - LCV VEHICLE	1-29				
EAX1458	0289929	DAF-LEYLAND DAF	3-12				
EAX1459	0299929	DAF-LEYLAND DAF	3-12				
HJK3892	0506167	DAF-LEYLAND DAF	3-1				
KT6C113K209AA	0403867	VEICOLI COMMERCIALI - LCV VEHICLE	1-26				
MAK1295	0196424	DAF-LEYLAND DAF	3-9				
MAK1296	0186424	DAF-LEYLAND DAF	3-9				
NAK3394	0197785	DAF-LEYLAND DAF	3-10				
NAK3395	0187785	DAF-LEYLAND DAF	3-9				
PAX1458	0299929	DAF-LEYLAND DAF	3-12				
PAX1459	0289929	DAF-LEYLAND DAF	3-12				
S009593	0507924	BREDAMENARINIBUS	12-1				
S009593	0507924	DAF-LEYLAND DAF	3-3				
S009593	0507924	SCANIA	10-4				
X50561	0807507	DAF-LEYLAND DAF	3-16				

Cross Reference Guide

RIF. OCAP REF. OCAP	RIF. ORIG O.E. NUMBER	MARCA	PAG.	RIF. OCAP REF. OCAP	RIF. ORIG O.E. NUMBER	MARCA	PAG.
0104151	2D0511329	VEICOLI COMMERCIALI - LCV VEHICLE	1-39	0186595	42480024	IVECO TRUCK	5-17
0109903	948372	VOLVO	11-25	0186595	81953010077	MAN	6-11
0109903	948372	VOLVO BUS	20-7	0186595	0003300335	MERCEDES	7-25
0180727	6013300635	MERCEDES	7-25	0186595	0003406252	RENAULT V.I.	9-11
0180727	6013300435	VEICOLI COMMERCIALI - LCV VEHICLE	1-42	0186595	1190778	VOLVO	11-14
0180729	0003300835	MERCEDES	7-29	0186595	1518142	VOLVO BUS	20-4
0180730	0003305035	MERCEDES	7-25	0186598	189716	BREDAMENARINIBUS	12-3
0180730	0003305035	MERCEDES BUS	16-8	0186598	0607981	DAF-LEYLAND DAF	3-10
0180730	5001836801	RENAULT V.I.	9-11	0186598	0607981	DAF BUS	13-1
0180730	0004604148	VEICOLI COMMERCIALI - LCV VEHICLE	1-43	0186598	2966252	IVECO BUS	14-4
0180947	7701461770	VEICOLI COMMERCIALI - LCV VEHICLE	1-81	0186598	2969808	IVECO TRUCK	5-18
0181322	508735	VEICOLI COMMERCIALI - LCV VEHICLE	1-8	0186598	81953010016	MAN	6-12
0181322-K	1308664080 *	VEICOLI COMMERCIALI - LCV VEHICLE	1-7	0186598	81953010016	MAN BUS	15-6
0181401	7701013272	VEICOLI COMMERCIALI - LCV VEHICLE	1-88	0186598	0004600348	MERCEDES	7-27
0181602	1300716080	VEICOLI COMMERCIALI - LCV VEHICLE	1-3	0186598	0004600348	MERCEDES BUS	16-10
0181724	6150970	VEICOLI COMMERCIALI - LCV VEHICLE	1-25	0186598	11019659	NEOPLAN BUS	17-6
0181785	3435788	IVECO TRUCK	5-38	0186598	0003401169	RENAULT V.I.	9-13
0182252	6083330027	VEICOLI COMMERCIALI - LCV VEHICLE	1-42	0186598	0003401169	RENAULT V.I. BUS	18-3
0182254	6023300035	VEICOLI COMMERCIALI - LCV VEHICLE	1-43	0186598	0283784	SCANIA	10-9
0182259	6313300535	VEICOLI COMMERCIALI - LCV VEHICLE	1-36	0186598	1358793	SCANIA BUS	19-3
0182260	0004607248	MERCEDES	7-25	0186599	4688948	IVECO BUS	14-4
0182260	0004607248	MERCEDES BUS	16-8	0186599	4688948	IVECO TRUCK	5-19
0182260	0004607248	VEICOLI COMMERCIALI - LCV VEHICLE	1-36	0186599	81953016184	MAN	6-13
0182261	0004606548	MERCEDES BUS	16-8	0186599	0013301835	MERCEDES	7-28
0182261	0004606548	VEICOLI COMMERCIALI - LCV VEHICLE	1-36	0186599	0003401207	RENAULT V.I.	9-13
0182344	-	RENAULT V.I.	9-12	0186601	814304	FIAT - OM	4-5
0182345	-	RENAULT V.I.	9-12	0186603	4018036	FIAT - OM	4-5
0182346	-	RENAULT V.I.	9-14	0186604	4028250	FIAT - OM	4-5
0182638	1350658080 Z	VEICOLI COMMERCIALI - LCV VEHICLE	1-6	0186604	4028250	IVECO BUS	14-4
0186424	0586753	DAF-LEYLAND DAF	3-9	0186605	4510019	FIAT - OM	4-6
0186424	0586753	DAF BUS	13-1	0186605	4664297	IVECO BUS	14-5
0186424	579342	IVECO BUS	14-4	0186608	1689604	DAF-LEYLAND DAF	3-8
0186424	2966688	IVECO TRUCK	5-18	0186608	4688941	IVECO TRUCK	5-18
0186424	81953010014	MAN	6-12	0186612	42487165	IVECO TRUCK	5-17
0186424	81953010014	MAN BUS	15-6	0186612	42487165	IVECO TRUCK	5-17
0186424	0003300248	MERCEDES	7-26	0186612	0003301235	MERCEDES	7-26
0186424	0003300248	MERCEDES BUS	16-9	0186612	0003301235	MERCEDES BUS	16-8
0186424	0013300135	NEOPLAN BUS	17-6	0186612	120324001	NEOPLAN BUS	17-5
0186424	0003406212	RENAULT V.I.	9-12	0186612	0003301235	VEICOLI COMMERCIALI - LCV VEHICLE	1-48
0186424	0003406212	RENAULT V.I. BUS	18-3	0186612	0003301235	VEICOLI COMMERCIALI - LCV VEHICLE	1-48
0186442	81953016263	MAN	6-14	0186612	1696919	VOLVO	11-14
0186442	6994601648	MERCEDES	7-28	0186613	0110197	DAF-LEYLAND DAF	3-8
0186547	0003303135	MERCEDES	7-27	0186613	2966321	IVECO TRUCK	5-17
0186547	0003303135	MERCEDES BUS	16-9	0186613	81953016060	MAN	6-11
0186551	0004605748	MERCEDES	7-27	0186613	0003301435	MERCEDES	7-26
0186592	11200360-0	NISSAN	8-3	0186613	0003301435	MERCEDES BUS	16-9
0186595	0608530	DAF-LEYLAND DAF	3-8	0186613	120325701	NEOPLAN BUS	17-5
				0186613	0003406242	RENAULT V.I.	9-11
				0186613	0003301435	VEICOLI COMMERCIALI - LCV VEHICLE	1-45
				0186613	1517440	VOLVO	11-14
				0186614	4579231	IVECO TRUCK	5-16
				0186620	4661613	IVECO BUS	14-5
				0186648	4665007	FIAT - OM	4-6
				0186649	4665005	FIAT - OM	4-6
				0186651	4562450	FIAT - OM	4-5
				0186653	4544893	FIAT - OM	4-5
				0186655	4688952	IVECO TRUCK	5-19
				0186656	4688951	IVECO TRUCK	5-19

Cross Reference Guide

RIF. OCAP REF. OCAP	RIF. ORIG O.E. NUMBER	MARCA	PAG.	RIF. OCAP REF. OCAP	RIF. ORIG O.E. NUMBER	MARCA	PAG.
0186657	4520697	FIAT - OM	4-6	0187467	6.851.491.000	MERCEDES BUS	16-10
0186684	4580778	FIAT - OM	4-6	0187467	120322305	NEOPLAN BUS	17-7
0186758	0122810	DAF-LEYLAND DAF	3-11	0187476	11019966	NEOPLAN BUS	17-7
0186758	0586714	MAN	6-13	0187530	0698586	DAF-LEYLAND DAF	3-12
0186758	0586714	MAN BUS	15-7	0187560	0003301035	MERCEDES	7-25
0186758	0586714	NEOPLAN BUS	17-7	0187560	0003301035	VEICOLI COMMERCIALI - LCV VEHICLE	1-45
0186758	0586714	SCANIA	10-9				
0186946	3090472	VOLVO	11-15	0187571	120326400	NEOPLAN BUS	17-6
0186948	1506269	VOLVO	11-15	0187682	382613	VOLVO	11-26
0186949	41005523	IVECO TRUCK	5-37	0187686	21263821	VOLVO	11-16
0186959	1505759	VOLVO	11-15	0187686	21263821	VOLVO BUS	20-4
0186959	1698846	VOLVO BUS	20-4	0187723	1603883	DAF-LEYLAND DAF	3-12
0186960	1507826	SCANIA BUS	19-3	0187723	81953016288	MAN	6-14
0186960	0356310	VOLVO	11-16	0187723	50 01 852 452	RENAULT V.I.	9-14
0186960	1507826	VOLVO BUS	20-4	0187723	1357674	SCANIA	10-10
0187137	0004607748	MERCEDES BUS	16-10	0187759	638869	SCANIA	10-13
0187146	0069867	DAF-LEYLAND DAF	3-9	0187772	639362	SCANIA	10-12
0187146	2980875	IVECO TRUCK	5-19	0187785	NAK3395	DAF-LEYLAND DAF	3-9
0187146	81953010025	MAN	6-13	0187789	0014604148	MERCEDES	7-29
0187146	0004600148	MERCEDES	7-27	0187803	ACU9240	DAF-LEYLAND DAF	3-13
0187146	0004600148	MERCEDES BUS	16-10	0187838	81953016096	MAN	6-11
0187146	120326000	NEOPLAN BUS	17-6	0187838	325615	SCANIA	10-9
0187146	5000808458	RENAULT V.I.	9-14	0187843	1389190	DAF-LEYLAND DAF	3-11
0187152	4580782	FIAT - OM	4-7	0187843	81953016270	MAN	6-14
0187156	2463583	IVECO TRUCK	5-35	0187843	81953016270	MAN BUS	15-7
0187157	2460515	IVECO TRUCK	5-34	0187854	-	RENAULT V.I.	9-13
0187158	61591070	IVECO TRUCK	5-17	0187856	-	RENAULT V.I.	9-14
0187160	4688944	IVECO TRUCK	5-19	0187884	5001860770	RENAULT V.I.	9-11
0187166	4664340	IVECO BUS	14-5	0187894	1785340	DAF-LEYLAND DAF	3-11
0187226	8578493	IVECO TRUCK	5-38	0187894	81953016271	MAN	6-14
0187228	0386930	DAF-LEYLAND DAF	3-22	0187894	81953016271	MAN BUS	15-7
0187228	42487482	IVECO BUS	14-11	0187894	1723897	SCANIA	10-9
0187228	8550139	IVECO TRUCK	5-37	0187900	5000297580	RENAULT V.I.	9-15
0187228	81953010038	MAN	6-26	0187903	5001866165	RENAULT V.I.	9-13
0187228	81953010038	MAN BUS	15-12	0187916	0014602948	MERCEDES	7-28
0187228	0002680189	MERCEDES	7-51	0187929	1604248	DAF-LEYLAND DAF	3-12
0187228	0023162046	RENAULT V.I.	9-25	0187959	0014603848	MERCEDES	7-27
0187228	0386930	SCANIA	10-20	0187971	0004604848	MERCEDES	7-29
0187228	1132493	VOLVO	11-26	0189896	21263974	VOLVO	11-16
0187230	0350270	SCANIA	10-20	0189914	20581089	VOLVO	11-16
0187231	1383405	SCANIA	10-20	0189926	1401944	DAF-LEYLAND DAF	3-9
0187234	8578492	IVECO TRUCK	5-38	0190727	6013300535	MERCEDES	7-25
0187241	1527234	VOLVO	11-26	0190727	6013300535	VEICOLI COMMERCIALI - LCV VEHICLE	1-42
0187278	2981461	IVECO TRUCK	5-18	0190729	0003302635	MERCEDES	7-29
0187342	0003305635	MERCEDES	7-26	0190731	0004602248	MERCEDES	7-29
0187342	0003305635	MERCEDES BUS	16-9	0190731	0004604248	VEICOLI COMMERCIALI - LCV VEHICLE	1-44
0187342	120326100	NEOPLAN BUS	17-5				
0187349	81953016092	MAN	6-14	0191401	7701013276	VEICOLI COMMERCIALI - LCV VEHICLE	1-88
0187364	500309296	IVECO TRUCK	5-19				
0187410	81953010089	MAN BUS	15-7	0191724	6150971	VEICOLI COMMERCIALI - LCV VEHICLE	1-25
0187435	0014605648	MERCEDES BUS	16-11				
0187456	1668179	VOLVO	11-26	0192252	6083380110	VEICOLI COMMERCIALI - LCV VEHICLE	1-42
0187460	-	NEOPLAN BUS	17-6	0192254	6023300135	VEICOLI COMMERCIALI - LCV VEHICLE	1-43
0187463	0697221	DAF-LEYLAND DAF	3-11	0192258	6313380410	VEICOLI COMMERCIALI - LCV VEHICLE	1-36
0187463	81953010091	MAN	6-13				
0187463	11019933	NEOPLAN BUS	17-7	0192260	6313300435	VEICOLI COMMERCIALI - LCV VEHICLE	1-37
0187465	120110403	NEOPLAN BUS	17-5				
0187467	0004601748	MERCEDES	7-28	0192345	-	RENAULT V.I.	9-12

Cross Reference Guide

RIF. OCAP REF. OCAP	RIF. ORIG O.E. NUMBER	MARCA	PAG.	RIF. OCAP REF. OCAP	RIF. ORIG O.E. NUMBER	MARCA	PAG.
0196424	0311300	DAF-LEYLAND DAF	3-9	0196946	3090728	VOLVO	11-15
0196424	0311300	DAF BUS	13-1	0196959	1505758	VOLVO	11-15
0196424	579343	IVECO BUS	14-4	0196959	1698847	VOLVO BUS	20-4
0196424	2980129	IVECO TRUCK	5-18	0196960	1131744	VOLVO	11-16
0196424	81953010013	MAN	6-12	0196960	1131744	VOLVO BUS	20-4
0196424	81953010013	MAN BUS	15-6	0196961	0004605848	MERCEDES	7-28
0196424	0003300035	MERCEDES	7-27	0197137	0004607848	MERCEDES BUS	16-10
0196424	0003300148	MERCEDES BUS	16-9	0197146	81953016070	MAN	6-13
0196424	0003300148	NEOPLAN BUS	17-6	0197146	0014607448	MERCEDES BUS	16-10
0196424	0003406213	RENAULT V.I.	9-12	0197166	4664341	IVECO BUS	14-5
0196424	1517647	VOLVO	11-15	0197342	120326200	MERCEDES BUS	16-9
0196592	11200361-0	NISSAN	8-3	0197342	120326200	NEOPLAN BUS	17-6
0196595	42480023	IVECO TRUCK	5-17	0197463	122169100	NEOPLAN BUS	17-7
0196595	81953010078	MAN	6-11	0197467	1203.223.00	MERCEDES	7-28
0196595	0003300235	MERCEDES	7-25	0197467	6.851.490.000	MERCEDES BUS	16-11
0196595	5000807553	RENAULT V.I.	9-11	0197467	120322300	NEOPLAN BUS	17-7
0196595	1517448	VOLVO	11-14	0197523	0638680	DAF-LEYLAND DAF	3-12
0196595	1517448	VOLVO BUS	20-4	0197523	81953016093	MAN	6-14
0196598	189717	BREDAMENARINIBUS	12-3	0197523	638680	SCANIA	10-13
0196598	0607053	DAF-LEYLAND DAF	3-10	0197751	639361	SCANIA	10-12
0196598	0607053	DAF BUS	13-1	0197756	5000297581	RENAULT V.I.	9-15
0196598	574274	IVECO BUS	14-5	0197785	NAK3394	DAF-LEYLAND DAF	3-10
0196598	2984061	IVECO TRUCK	5-18	0197803	ACU9239	DAF-LEYLAND DAF	3-13
0196598	81953010015	MAN	6-13	0197854	-	RENAULT V.I.	9-13
0196598	81953010015	MAN BUS	15-6	0197884	5001860769	RENAULT V.I.	9-11
0196598	0004600648	MERCEDES	7-27	0197928	1401942	DAF-LEYLAND DAF	3-10
0196598	0004600648	MERCEDES BUS	16-10	0197929	1604247	DAF-LEYLAND DAF	3-12
0196598	11019661	NEOPLAN BUS	17-6	0197971	0004608448	MERCEDES	7-29
0196598	0003401170	RENAULT V.I.	9-13	0199914	20710008	VOLVO	11-16
0196598	1358792	SCANIA	10-9	0199928	1310760	DAF-LEYLAND DAF	3-11
0196598	1358792	SCANIA BUS	19-3	0280037	1306003080	VEICOLI COMMERCIALI - LCV VEHICLE	1-7
0196599	4688949	IVECO TRUCK	5-19	0280513	4336779	IVECO TRUCK	5-16
0196599	0003401206	RENAULT V.I.	9-13	0280513	9750079980	VEICOLI COMMERCIALI - LCV VEHICLE	1-11
0196601	814305	FIAT - OM	4-5	0280515	1903652	IVECO TRUCK	5-16
0196603	4018037	FIAT - OM	4-5	0280515	1903652	VEICOLI COMMERCIALI - LCV VEHICLE	1-31
0196604	4028251	FIAT - OM	4-5	0280517	500310933	IVECO TRUCK	5-34
0196604	4028251	IVECO BUS	14-4	0280517	93802209	VEICOLI COMMERCIALI - LCV VEHICLE	1-31
0196605	4523292	FIAT - OM	4-6	0280886	171419811	VEICOLI COMMERCIALI - LCV VEHICLE	1-93
0196608	1689605	DAF-LEYLAND DAF	3-8	0281143	1306716080	IVECO TRUCK	5-18
0196608	4688942	IVECO TRUCK	5-18	0281143	1306716080	VEICOLI COMMERCIALI - LCV VEHICLE	1-1
0196612	7984276	IVECO TRUCK	5-17	0281405	701419812	VEICOLI COMMERCIALI - LCV VEHICLE	1-95
0196612	0003301335	MERCEDES	7-26	0281407	701419812A	VEICOLI COMMERCIALI - LCV VEHICLE	1-96
0196612	0003301335	MERCEDES BUS	16-8	0281411	701419812B	VEICOLI COMMERCIALI - LCV VEHICLE	1-98
0196612	120324002	NEOPLAN BUS	17-5	0281413	701419812D	VEICOLI COMMERCIALI - LCV VEHICLE	1-99
0196612	0003301335	VEICOLI COMMERCIALI - LCV VEHICLE	1-48	0281495	4501263	VEICOLI COMMERCIALI - LCV VEHICLE	1-55
0196612	1696920	VOLVO	11-15	0281503	9014600048	MERCEDES BUS	16-8
0196613	0110196	DAF-LEYLAND DAF	3-8	0281503	2D0422811	VEICOLI COMMERCIALI - LCV VEHICLE	1-38
0196613	2969507	IVECO TRUCK	5-17	0281536	4420098	VEICOLI COMMERCIALI - LCV VEHICLE	1-59
0196613	81953010079	MAN	6-12				
0196613	0003303335	MERCEDES	7-26				
0196613	0003303335	MERCEDES BUS	16-9				
0196613	120325702	NEOPLAN BUS	17-5				
0196613	5000823947	RENAULT V.I.	9-12				
0196613	1517279	VOLVO	11-14				
0196614	4579232	IVECO TRUCK	5-17				
0196620	4661614	IVECO BUS	14-5				
0196758	1337366	SCANIA	10-9				



Cross Reference Guide

RIF. OCAP REF. OCAP	RIF. ORIG O.E. NUMBER	MARCA	PAG.	RIF. OCAP REF. OCAP	RIF. ORIG O.E. NUMBER	MARCA	PAG.
0281725	10391031	VEICOLI COMMERCIALI - LCV VEHICLE	1-24	0287291	9281792	IVECO TRUCK	5-17
0281786	41002118	IVECO TRUCK	5-37	0287291	120164610	NEOPLAN BUS	17-5
0281904	6384600048	MERCEDES BUS	16-8	0287291	7485114029	RENAULT V.I.	9-11
0281904	6384600048	VEICOLI COMMERCIALI - LCV VEHICLE	1-51	0287294	42071290	IVECO TRUCK	5-37
0282240	7701462427	VEICOLI COMMERCIALI - LCV VEHICLE	1-76	0287294	90804105207	MAN	6-26
0282323	4018E0	VEICOLI COMMERCIALI - LCV VEHICLE	1-1	0287294	90804105207	MAN BUS	15-12
0282637	381770	VEICOLI COMMERCIALI - LCV VEHICLE	1-5	0287313	42105474	IVECO TRUCK	5-16
0282717	9064600048	VEICOLI COMMERCIALI - LCV VEHICLE	1-40	0287313	6244600348	MERCEDES	7-25
0282733	381773	VEICOLI COMMERCIALI - LCV VEHICLE	1-9	0287319	42485639	IVECO TRUCK	5-37
0283815	77362279	VEICOLI COMMERCIALI - LCV VEHICLE	1-20	0287320	42530316	IVECO TRUCK	5-16
0283867	1138275	VEICOLI COMMERCIALI - LCV VEHICLE	1-26	0287350	5000803460	RENAULT V.I.	9-15
0283875	4408511	VEICOLI COMMERCIALI - LCV VEHICLE	1-61	0287360	42533101	IVECO TRUCK	5-16
0284249	6384600048	VEICOLI COMMERCIALI - LCV VEHICLE	1-53	0287360	81953016281	MAN	6-11
0284333	7H0422818A	VEICOLI COMMERCIALI - LCV VEHICLE	1-101	0287360	0014606948	MERCEDES BUS	16-8
0286427	0606923	DAF-LEYLAND DAF	3-10	0287360	5001849880	RENAULT V.I.	9-11
0286427	0606923	DAF BUS	13-1	0287361	1394444	SCANIA	10-9
0286428	0067389	DAF-LEYLAND DAF	3-10	0287361	42533073	IVECO TRUCK	5-16
0286606	4510017	FIAT - OM	4-7	0287361	81953016280	MAN	6-11
0286610	4514235	FIAT - OM	4-7	0287361	0004634429	MERCEDES	7-25
0286616	500337201	VEICOLI COMMERCIALI - LCV VEHICLE	1-31	0287361	0004634429	MERCEDES BUS	16-8
0286641	5000288362	RENAULT V.I.	9-15	0287361	11019859	NEOPLAN BUS	17-5
0286647	4665009	FIAT - OM	4-6	0287361	5001849879	RENAULT V.I.	9-11
0286650	4514245	FIAT - OM	4-7	0287361	1394443	SCANIA	10-9
0286652	4582159	FIAT - OM	4-7	0287457	1607483	VOLVO	11-14
0286658	4665422	FIAT - OM	4-8	0287458	8151876	VOLVO	11-14
0286659	4536229	FIAT - OM	4-5	0287466	0004632329	NEOPLAN BUS	17-5
0286665	4025438	FIAT - OM	4-7	0287503	0273203	DAF-LEYLAND DAF	3-8
0286666	4533777	FIAT - OM	4-7	0287519	0608122	DAF-LEYLAND DAF	3-12
0286759	0310980	SCANIA	10-10	0287552	42534911	IVECO BUS	14-4
0286964	1131742	VOLVO	11-16	0287552	42534911	VEICOLI COMMERCIALI - LCV VEHICLE	1-31
0286964	1131742	VOLVO BUS	20-4	0287646	0002685589	MERCEDES	7-51
0287136	0003302835	MERCEDES	7-28	0287684	81953016071	MAN	6-11
0287136	0003302835	MERCEDES BUS	16-11	0287684	0004604948	MERCEDES	7-26
0287136	0003304035	NEOPLAN BUS	17-7	0287684	1375228	SCANIA	10-9
0287150	4664090	FIAT - OM	4-6	0287684	1606980	VOLVO	11-14
0287151	4664088	FIAT - OM	4-6	0287724	1235514	DAF-LEYLAND DAF	3-11
0287159	4688946	IVECO TRUCK	5-19	0287752	11100521	RENAULT V.I.	9-14
0287229	1249129	DAF-LEYLAND DAF	3-22	0287753	0003401151	RENAULT V.I.	9-15
0287229	8198187	IVECO TRUCK	5-37	0287881	1315878	MERCEDES BUS	16-9
0287229	81953016064	MAN	6-26	0287892	5000288364	RENAULT V.I.	9-14
0287229	81953016064	MAN BUS	15-12	0287906	1394446	IVECO TRUCK	5-16
0287229	0002684689	MERCEDES	7-51	0287906	42533102	MAN	6-11
0287229	5010129530	RENAULT V.I.	9-25	0287907	0004606748	MAN BUS	15-7
0287229	1384898	SCANIA	10-20	0287907	0004606748	MERCEDES BUS	16-11
0287229	1696685	VOLVO	11-26	0288003	-	IVECO TRUCK	5-20
0287229	1696685	VOLVO BUS	20-8	0289923	1271126	DAF-LEYLAND DAF	3-8
0287238	93192809	IVECO BUS	14-4	0289923	1271126	IVECO TRUCK	5-16
0287238	93192809	IVECO TRUCK	5-20	0289923	1271126	MAN	6-11
0287291	0817824	DAF-LEYLAND DAF	3-8	0289923	1271126	VOLVO	11-14
				0289927	1344684	DAF-LEYLAND DAF	3-9
				0289929	6K13312	DAF-LEYLAND DAF	3-12
				0291405	701419811A	VEICOLI COMMERCIALI - LCV VEHICLE	1-95
				0291407	701419811B	VEICOLI COMMERCIALI - LCV VEHICLE	1-96
				0291411	701419811C	VEICOLI COMMERCIALI - LCV VEHICLE	1-98

Cross Reference Guide

RIF. OCAP REF. OCAP	RIF. ORIG O.E. NUMBER	MARCA	PAG.	RIF. OCAP REF. OCAP	RIF. ORIG O.E. NUMBER	MARCA	PAG.
0291413	701419811E	VEICOLI COMMERCIALI - LCV VEHICLE	1-99	0381536	4419216	VEICOLI COMMERCIALI - LCV VEHICLE	1-59
0291495	4501262	VEICOLI COMMERCIALI - LCV VEHICLE	1-55	0382638	1352225080	VEICOLI COMMERCIALI - LCV VEHICLE	1-5
0291536	4420097	VEICOLI COMMERCIALI - LCV VEHICLE	1-59	0382639	1352226080	VEICOLI COMMERCIALI - LCV VEHICLE	1-6
0291786	41002119	IVECO TRUCK	5-37	0382723	7H0407152E	VEICOLI COMMERCIALI - LCV VEHICLE	1-102
0292637	381777	VEICOLI COMMERCIALI - LCV VEHICLE	1-5	0382734	1497407080	VEICOLI COMMERCIALI - LCV VEHICLE	1-9
0293875	7701049282	VEICOLI COMMERCIALI - LCV VEHICLE	1-61	0383875	4422270	VEICOLI COMMERCIALI - LCV VEHICLE	1-64
0294249	6394600048	VEICOLI COMMERCIALI - LCV VEHICLE	1-53	0384627	4417178	VEICOLI COMMERCIALI - LCV VEHICLE	1-62
0294333	7H0422817A	VEICOLI COMMERCIALI - LCV VEHICLE	1-101	0385072	542150012	VEICOLI COMMERCIALI - LCV VEHICLE	1-35
0296427	0606922	DAF-LEYLAND DAF	3-10	0390405	4391814	VEICOLI COMMERCIALI - LCV VEHICLE	1-12
0296427	0606922	DAF BUS	13-1	0390406	7695191	VEICOLI COMMERCIALI - LCV VEHICLE	1-12
0296428	67303	DAF-LEYLAND DAF	3-10	0390565	7695186	VEICOLI COMMERCIALI - LCV VEHICLE	1-12
0296606	4510018	FIAT - OM	4-7	0391140	1308759080	VEICOLI COMMERCIALI - LCV VEHICLE	1-3
0296610	4514236	FIAT - OM	4-8	0391141	1308600080	VEICOLI COMMERCIALI - LCV VEHICLE	1-2
0296641	5000288363	RENAULT V.I.	9-15	0391184	1313083080	VEICOLI COMMERCIALI - LCV VEHICLE	1-7
0296759	0310979	SCANIA	10-10	0391446	1331938080	VEICOLI COMMERCIALI - LCV VEHICLE	1-2
0296964	1131741	VOLVO	11-16	0391451	1331937080	VEICOLI COMMERCIALI - LCV VEHICLE	1-3
0296964	1131741	VOLVO BUS	20-5	0391494	4418212	VEICOLI COMMERCIALI - LCV VEHICLE	1-55
0297136	0003302935	MERCEDES	7-28	0391536	4419215	VEICOLI COMMERCIALI - LCV VEHICLE	1-60
0297136	0003302935	MERCEDES BUS	16-11	0392638	1352227080	VEICOLI COMMERCIALI - LCV VEHICLE	1-5
0297136	0003301935	NEOPLAN BUS	17-7	0392639	1352228080	VEICOLI COMMERCIALI - LCV VEHICLE	1-6
0297229	0592106	DAF-LEYLAND DAF	3-22	0392723	7H0407151E	VEICOLI COMMERCIALI - LCV VEHICLE	1-102
0297229	42485638	IVECO TRUCK	5-37	0392734	1497408080	VEICOLI COMMERCIALI - LCV VEHICLE	1-9
0297229	81953016063	MAN	6-26	0393875	4422269	VEICOLI COMMERCIALI - LCV VEHICLE	1-65
0297229	81953016063	MAN BUS	15-12	0394627	4417177	VEICOLI COMMERCIALI - LCV VEHICLE	1-62
0297229	0002684789	MERCEDES	7-51	0395072	542150011	VEICOLI COMMERCIALI - LCV VEHICLE	1-35
0297229	5001000134	RENAULT V.I.	9-25	0400096	7567284	IVECO TRUCK	5-34
0297229	1384897	SCANIA	10-20	0400096	7567284	VEICOLI COMMERCIALI - LCV VEHICLE	1-12
0297229	1696684	VOLVO	11-26	0400097	4388159	IVECO TRUCK	5-34
0297229	1696684	VOLVO BUS	20-8	0400097	4388159	VEICOLI COMMERCIALI - LCV VEHICLE	1-11
0297350	5000803459	RENAULT V.I.	9-15	0400518	93802242	IVECO TRUCK	5-35
0297519	0608123	DAF-LEYLAND DAF	3-13	0400518	93802242	VEICOLI COMMERCIALI - LCV VEHICLE	1-31
0297724	1235515	DAF-LEYLAND DAF	3-11	0400888	251407361	VEICOLI COMMERCIALI - LCV VEHICLE	1-93
0297752	11100492	RENAULT V.I.	9-14	0400889	251407187A	VEICOLI COMMERCIALI - LCV VEHICLE	1-93
0297753	0003401152	RENAULT V.I.	9-15	0400951	5000246731	VEICOLI COMMERCIALI - LCV VEHICLE	1-88
0297796	1205248	DAF-LEYLAND DAF	3-11	0400952	5000246732	VEICOLI COMMERCIALI - LCV VEHICLE	1-88
0297892	5000288365	RENAULT V.I.	9-14	0401127	1055194	VEICOLI COMMERCIALI - LCV VEHICLE	1-24
0299929	6K13313	DAF-LEYLAND DAF	3-12				
0380405	4391813	VEICOLI COMMERCIALI - LCV VEHICLE	1-11				
0380406	7695190	VEICOLI COMMERCIALI - LCV VEHICLE	1-12				
0380565	7695185	VEICOLI COMMERCIALI - LCV VEHICLE	1-12				
0381140	1308760080	VEICOLI COMMERCIALI - LCV VEHICLE	1-2				
0381141	1308601080	VEICOLI COMMERCIALI - LCV VEHICLE	1-1				
0381184	1313084080	VEICOLI COMMERCIALI - LCV VEHICLE	1-7				
0381446	1331940080	VEICOLI COMMERCIALI - LCV VEHICLE	1-2				
0381451	1331939080	VEICOLI COMMERCIALI - LCV VEHICLE	1-3				
0381494	4404048	VEICOLI COMMERCIALI - LCV VEHICLE	1-55				

Cross Reference Guide

RIF. OCAP REF. OCAP	RIF. ORIG O.E. NUMBER	MARCA	PAG.	RIF. OCAP REF. OCAP	RIF. ORIG O.E. NUMBER	MARCA	PAG.
0401137	1302368080	IVECO TRUCK	5-34	0407219	5000489779	RENAULT V.I. BUS	18-6
0401137	1302368080	VEICOLI COMMERCIALI - LCV VEHICLE	1-1	0407232	307443	SCANIA	10-20
0401138	1300473080	IVECO TRUCK	5-34	0407249	500334713	IVECO TRUCK	5-35
0401138	1300473080	VEICOLI COMMERCIALI - LCV VEHICLE	1-2	0407249	-	VEICOLI COMMERCIALI - LCV VEHICLE	1-31
0401398	5000246729	VEICOLI COMMERCIALI - LCV VEHICLE	1-88	0407250	500334716	IVECO TRUCK	5-35
0401399	5000246730	VEICOLI COMMERCIALI - LCV VEHICLE	1-88	0407250	-	VEICOLI COMMERCIALI - LCV VEHICLE	1-32
0401409	701407187A	VEICOLI COMMERCIALI - LCV VEHICLE	1-96	0407893	504212586	VEICOLI COMMERCIALI - LCV VEHICLE	1-34
0401410	701407361B	VEICOLI COMMERCIALI - LCV VEHICLE	1-96	0407894	5801378064	VEICOLI COMMERCIALI - LCV VEHICLE	1-34
0401425	7D0407361	VEICOLI COMMERCIALI - LCV VEHICLE	1-99	0409919	5010556210	IVECO BUS	14-9
0401446	1331640080	IVECO TRUCK	5-34	0500730	3094600305	MERCEDES	7-8
0401446	1331640080	VEICOLI COMMERCIALI - LCV VEHICLE	1-2	0500730	3094600305	VEICOLI COMMERCIALI - LCV VEHICLE	1-43
0401451	1331641080	IVECO TRUCK	5-34	0501112	9790002680	VEICOLI COMMERCIALI - LCV VEHICLE	1-11
0401451	1331641080	VEICOLI COMMERCIALI - LCV VEHICLE	1-3	0501347	6014300535	VEICOLI COMMERCIALI - LCV VEHICLE	1-44
0401494	40160-00QAD	VEICOLI COMMERCIALI - LCV VEHICLE	1-55	0501443	7014111049	VEICOLI COMMERCIALI - LCV VEHICLE	1-97
0401505	2D0407361A	VEICOLI COMMERCIALI - LCV VEHICLE	1-38	0501496	4419304	VEICOLI COMMERCIALI - LCV VEHICLE	1-60
0401522	40160-00QAB	VEICOLI COMMERCIALI - LCV VEHICLE	1-55	0501499	6673300603	MERCEDES	7-3
0401523	4401910	VEICOLI COMMERCIALI - LCV VEHICLE	1-58	0501499	6673300303	VEICOLI COMMERCIALI - LCV VEHICLE	1-47
0401536	401608374R	VEICOLI COMMERCIALI - LCV VEHICLE	1-59	0501501	251419803	VEICOLI COMMERCIALI - LCV VEHICLE	1-93
0401906	6383330027	VEICOLI COMMERCIALI - LCV VEHICLE	1-51	0501503	2D0422803	VEICOLI COMMERCIALI - LCV VEHICLE	1-38
0402159	0003200028	MERCEDES	7-50	0501536	4419291	VEICOLI COMMERCIALI - LCV VEHICLE	1-60
0402159	0003200028	MERCEDES BUS	16-19	0501904	6384600205	VEICOLI COMMERCIALI - LCV VEHICLE	1-51
0402159	0003200028	VEICOLI COMMERCIALI - LCV VEHICLE	1-37	0502230	7701463035	VEICOLI COMMERCIALI - LCV VEHICLE	1-81
0402235	7701461667	VEICOLI COMMERCIALI - LCV VEHICLE	1-82	0502231	7701462987	VEICOLI COMMERCIALI - LCV VEHICLE	1-81
0402241	7701462692	VEICOLI COMMERCIALI - LCV VEHICLE	1-76	0502252	6083300303	VEICOLI COMMERCIALI - LCV VEHICLE	1-42
0402242	7701462693	VEICOLI COMMERCIALI - LCV VEHICLE	1-76	0502253	6023300003	VEICOLI COMMERCIALI - LCV VEHICLE	1-42
0402638	364067	VEICOLI COMMERCIALI - LCV VEHICLE	1-5	0502254	6023300903	VEICOLI COMMERCIALI - LCV VEHICLE	1-42
0402742	-	VEICOLI COMMERCIALI - LCV VEHICLE	1-40	0502255	5829067053	VEICOLI COMMERCIALI - LCV VEHICLE	1-43
0403808	-	VEICOLI COMMERCIALI - LCV VEHICLE	1-61	0502256	6084600105	VEICOLI COMMERCIALI - LCV VEHICLE	1-43
0403867	1417351	VEICOLI COMMERCIALI - LCV VEHICLE	1-26	0502257	6014600505	MERCEDES	7-8
0403869	4120734	VEICOLI COMMERCIALI - LCV VEHICLE	1-26	0502257	6014600505	VEICOLI COMMERCIALI - LCV VEHICLE	1-43
0403875	4422270 *	VEICOLI COMMERCIALI - LCV VEHICLE	1-64	0502258	6313300303	VEICOLI COMMERCIALI - LCV VEHICLE	1-36
0404001	251407187C	VEICOLI COMMERCIALI - LCV VEHICLE	1-93	0502259	6313300603	MERCEDES BUS	16-1
0404260	-	VEICOLI COMMERCIALI - LCV VEHICLE	1-53	0502259	6313300603	VEICOLI COMMERCIALI - LCV VEHICLE	1-36
0404335	7H8407361	VEICOLI COMMERCIALI - LCV VEHICLE	1-101	0502260	6313300503	VEICOLI COMMERCIALI - LCV VEHICLE	1-36
0404336	7H0407361	VEICOLI COMMERCIALI - LCV VEHICLE	1-101	0502261	6314600705	VEICOLI COMMERCIALI - LCV VEHICLE	1-37
0404627	4431869	VEICOLI COMMERCIALI - LCV VEHICLE	1-62	0502368	9013200689	VEICOLI COMMERCIALI - LCV VEHICLE	1-39
0405069	542410018	VEICOLI COMMERCIALI - LCV VEHICLE	1-35	0502379	9013200589	VEICOLI COMMERCIALI - LCV VEHICLE	1-39
				0502735	1400099680	VEICOLI COMMERCIALI - LCV VEHICLE	1-10

Cross Reference Guide

RIF. OCAP REF. OCAP	RIF. ORIG O.E. NUMBER	MARCA	PAG.	RIF. OCAP REF. OCAP	RIF. ORIG O.E. NUMBER	MARCA	PAG.
0502744	6013201389	VEICOLI COMMERCIALI - LCV VEHICLE	1-41	0506679	5010060764	RENAULT V.I.	9-4
0503254	1495685	VEICOLI COMMERCIALI - LCV VEHICLE	1-28	0506680	5000787472	RENAULT V.I.	9-5
0503520	1355449080 Z	VEICOLI COMMERCIALI - LCV VEHICLE	1-6	0506681	5010294287	RENAULT V.I.	9-5
0503864	701411049B	VEICOLI COMMERCIALI - LCV VEHICLE	1-97	0506682	5010294502	RENAULT V.I.	9-6
0503870	3736028	VEICOLI COMMERCIALI - LCV VEHICLE	1-28	0506683	5010130393	RENAULT V.I.	9-6
0503871	4042068	VEICOLI COMMERCIALI - LCV VEHICLE	1-28	0506684	5010294288	RENAULT V.I.	9-5
0503872	4440885	VEICOLI COMMERCIALI - LCV VEHICLE	1-28	0506685	5010294289	RENAULT V.I.	9-6
0503878	4408904	VEICOLI COMMERCIALI - LCV VEHICLE	1-63	0506686	5010037418	RENAULT V.I.	9-7
0504160	6383260116	VEICOLI COMMERCIALI - LCV VEHICLE	1-52	0506687	5010229242	RENAULT V.I.	9-7
0504337	7H5411317	VEICOLI COMMERCIALI - LCV VEHICLE	1-102	0506688	5000932435	RENAULT V.I.	9-5
0506167	1408040	DAF-LEYLAND DAF	3-1	0506689	0023123262	RENAULT V.I.	9-4
0506167	9703300003	MERCEDES	7-5	0506690	5000352082	RENAULT V.I.	9-7
0506168	1407963	DAF-LEYLAND DAF	3-1	0506691	5010130740	RENAULT V.I.	9-10
0506429	0094029	DAF-LEYLAND DAF	3-5	0506692	5000761670	RENAULT V.I. BUS	18-2
0506430	0094038	DAF-LEYLAND DAF	3-5	0506693	5000932435	RENAULT V.I.	9-8
0506431	0094016	DAF-LEYLAND DAF	3-3	0506693	5000932435	RENAULT V.I. BUS	18-2
0506432	1286343	DAF-LEYLAND DAF	3-1	0506694	5000998430	RENAULT V.I. BUS	18-2
0506433	1291060	DAF-LEYLAND DAF	3-6	0506695	0023123224	RENAULT V.I.	9-2
0506434	1247957	DAF-LEYLAND DAF	3-4	0506697	5000613837	RENAULT V.I.	9-1
0506435	1247956	DAF-LEYLAND DAF	3-5	0506699	5000446681	RENAULT V.I.	9-1
0506436	81466106281	MAN	6-5	0506709	4626917	FIAT - OM	4-2
0506443	81466106333	MAN	6-9	0506710	4665209	FIAT - OM	4-2
0506444	81466106280	MAN	6-6	0506711	4665501	FIAT - OM	4-2
0506445	81466106088	MAN	6-5	0506712	4520694	FIAT - OM	4-1
0506446	81466106001	MAN	6-6	0506714	4692686	FIAT - OM	4-2
0506542	7166384	IVECO TRUCK	5-1	0506716	4699246	IVECO TRUCK	5-13
0506553	4835068	IVECO TRUCK	5-3	0506717	4699305	IVECO TRUCK	5-10
0506575	3874600405	MERCEDES	7-18	0506720	4624032	FIAT - OM	4-4
0506576	6754601005	MERCEDES	7-12	0506721	4624116	FIAT - OM	4-4
0506576	6754601005	MERCEDES BUS	16-5	0506723	4666933	FIAT - OM	4-4
0506577	6764600105	MERCEDES	7-12	0506725	8557536	IVECO TRUCK	5-5
0506577	6764600105	MERCEDES BUS	16-5	0506726	8558522	IVECO TRUCK	5-7
0506578	6194602505	MERCEDES	7-15	0506728	8558540	IVECO TRUCK	5-6
0506579	3874600005	MERCEDES	7-18	0506733	8526148	FIAT - OM	4-1
0506580	3874600605	MERCEDES	7-15	0506736	8567618	IVECO TRUCK	5-6
0506581	6754601205	MERCEDES	7-11	0506737	8564248	IVECO TRUCK	5-6
0506581	6754601205	MERCEDES BUS	16-5	0506738	8788387	FIAT - OM	4-3
0506582	0014602905	MERCEDES	7-14	0506740	8788641	FIAT - OM	4-3
0506583	6734600205	MERCEDES	7-11	0506741	61590910	IVECO TRUCK	5-11
0506584	3834600805	MERCEDES	7-19	0506743	61593332	IVECO TRUCK	5-11
0506585	0004607105	MERCEDES	7-17	0506745	61595371	IVECO TRUCK	5-11
0506586	6773300303	MERCEDES	7-2	0506746	61590824	IVECO TRUCK	5-14
0506588	11200265-0	NISSAN	8-1	0506750	4666991	FIAT - OM	4-4
0506590	11200454-0	NISSAN	8-2	0506751	5000785429	RENAULT V.I.	9-6
0506591	11505036-0	NISSAN	8-2	0506753	4520698	FIAT - OM	4-1
0506595	5000393080	RENAULT V.I.	9-1	0506754	5010308082	RENAULT V.I.	9-2
0506613	60103171	IVECO TRUCK	5-1	0506755	2476066	IVECO TRUCK	5-4
0506642	0000712758	RENAULT V.I.	9-9	0506762	42044493	IVECO BUS	14-1
0506676	5000725267	RENAULT V.I.	9-8	0506764	4765442	IVECO TRUCK	5-15
0506677	5000745719	RENAULT V.I.	9-9	0506774	4659860	IVECO BUS	14-3
0506678	5010130739	RENAULT V.I.	9-9	0506781	4672795	IVECO BUS	14-3
				0506788	2476050	IVECO TRUCK	5-3
				0506794	2475843	IVECO TRUCK	5-3
				0506795	2506671	IVECO BUS	14-2
				0506810	4704183	IVECO TRUCK	5-12
				0506812	8570528	IVECO TRUCK	5-5
				0506814	2458534	IVECO TRUCK	5-7
				0506816	0278665	SCANIA	10-6



Cross Reference Guide

RIF. OCAP REF. OCAP	RIF. ORIG O.E. NUMBER	MARCA	PAG.	RIF. OCAP REF. OCAP	RIF. ORIG O.E. NUMBER	MARCA	PAG.
0506817	98427667	IVECO TRUCK	5-4	0506971	4668258	FIAT - OM	4-4
0506818	2478910	IVECO TRUCK	5-2	0506976	4588688	FIAT - OM	4-2
0506820	4773359	IVECO TRUCK	5-14	0506977	4568702	FIAT - OM	4-2
0506826	4793166	IVECO TRUCK	5-13	0506981	4574457	FIAT - OM	4-3
0506827	42037384	IVECO TRUCK	5-2	0506984	4520744	FIAT - OM	4-4
0506828	42202358	IVECO TRUCK	5-10	0506987	4545422	FIAT - OM	4-3
0506829	352637	SCANIA	10-6	0506991	8535664	FIAT - OM	4-1
0506839	4715615	IVECO TRUCK	5-11	0506993	8525704	FIAT - OM	4-1
0506840	4207841	IVECO TRUCK	5-14	0506994	4844041	IVECO TRUCK	5-3
0506846	291395	SCANIA	10-4	0507100	1592940	VOLVO	11-7
0506847	42003432	IVECO TRUCK	5-4	0507101	1592939	VOLVO	11-7
0506848	42042950	IVECO TRUCK	5-10	0507102	1576093	VOLVO	11-9
0506851	2454629	IVECO TRUCK	5-5	0507103	1576816	VOLVO	11-11
0506854	2461519	IVECO TRUCK	5-7	0507104	1610074	VOLVO	11-6
0506855	42001325	IVECO TRUCK	5-9	0507105	1080788	VOLVO	11-6
0506856	42043293	IVECO TRUCK	5-7	0507106	1080787	VOLVO	11-6
0506858	2519077	IVECO TRUCK	5-6	0507107	1075005	VOLVO	11-8
0506860	2444423	IVECO TRUCK	5-8	0507108	1075006	VOLVO	11-8
0506869	1304571	SCANIA	10-6	0507109	1505855	VOLVO	11-1
0506881	2443499	IVECO TRUCK	5-3	0507109	1626494	VOLVO BUS	20-1
0506887	8590435	IVECO TRUCK	5-5	0507111	1075663	VOLVO	11-7
0506888	345124	SCANIA	10-6	0507112	1075153	VOLVO	11-10
0506889	278663	SCANIA	10-6	0507113	1075153	VOLVO	11-10
0506893	42204473	IVECO TRUCK	5-10	0507114	1080786	VOLVO	11-6
0506894	98446354	IVECO TRUCK	5-10	0507115	20400941	VOLVO	11-10
0506897	41005472	IVECO TRUCK	5-8	0507116	20400909	VOLVO	11-12
0506904	42037386	IVECO TRUCK	5-1	0507117	1071169	VOLVO	11-5
0506904	5000350120	RENAULT V.I.	9-1	0507118	1071344	VOLVO	11-10
0506913	0390784	SCANIA	10-5	0507119	1094912	VOLVO	11-5
0506914	291398	SCANIA	10-4	0507120	1075664	VOLVO	11-8
0506915	4815933	IVECO TRUCK	5-11	0507121	3124962	VOLVO	11-10
0506916	1308643	SCANIA	10-8	0507122	1071315	VOLVO	11-11
0506918	0306981	SCANIA	10-7	0507124	1412254	VOLVO	11-2
0506919	0370875	SCANIA	10-5	0507127	004909	BREDAMENARINIBUS	12-1
0506920	1356055	SCANIA	10-7	0507128	004908	BREDAMENARINIBUS	12-1
0506927	41005456	IVECO TRUCK	5-5	0507131	065472	BREDAMENARINIBUS	12-1
0506928	42200700	IVECO TRUCK	5-8	0507133	043102	BREDAMENARINIBUS	12-2
0506931	41005463	IVECO BUS	14-2	0507138	3004600405	MERCEDES BUS	16-6
0506931	41005463	IVECO TRUCK	5-12	0507138	3004600405	NEOPLAN BUS	17-4
0506932	41005450	IVECO TRUCK	5-4	0507139	3004600605	MERCEDES BUS	16-5
0506933	432698	SCANIA BUS	19-2	0507139	3004600305	NEOPLAN BUS	17-4
0506936	1112511	SCANIA	10-5	0507140	3004600205	MERCEDES BUS	16-4
0506937	1369411	SCANIA	10-1	0507141	3574601005	MERCEDES BUS	16-6
0506938	466881	SCANIA BUS	19-1	0507142	3054600605	MERCEDES BUS	16-7
0506939	0301369	SCANIA	10-2	0507143	3734600505	MERCEDES BUS	16-6
0506950	500307556	IVECO TRUCK	5-2	0507144	3563300103	MERCEDES BUS	16-4
0506951	98402544	IVECO TRUCK	5-7	0507153	8558653	FIAT - OM	4-3
0506952	4854874	IVECO TRUCK	5-9	0507154	4546822	FIAT - OM	4-3
0506953	4854871	IVECO TRUCK	5-3	0507155	7136367	FIAT - OM	4-4
0506955	42117267	IVECO TRUCK	5-1	0507161	4722108	IVECO TRUCK	5-13
0506956	98449025	IVECO TRUCK	5-8	0507163	61591070	IVECO TRUCK	5-13
0506962	3874600705	MERCEDES	7-15	0507164	8573757	IVECO TRUCK	5-5
0506963	3834600605	MERCEDES	7-19	0507165	4741171	IVECO TRUCK	5-36
0506965	1584620	VOLVO	11-4	0507167	4557357	IVECO BUS	14-2
0506966	1508557	VOLVO	11-4	0507168	4668771	IVECO BUS	14-3
0506967	1610338	VOLVO	11-6	0507169	4704239	IVECO BUS	14-2
0506968	1613562	VOLVO	11-7	0507170	42019074	IVECO BUS	14-2
0506969	1576092	VOLVO	11-9	0507171	8533963	FIAT - OM	4-1

Cross Reference Guide

RIF. OCAP REF. OCAP	RIF. ORIG O.E. NUMBER	MARCA	PAG.	RIF. OCAP REF. OCAP	RIF. ORIG O.E. NUMBER	MARCA	PAG.
0507188	0382774	SCANIA	10-3	0507426	3574602505	MERCEDES BUS	16-5
0507189	470272	SCANIA BUS	19-2	0507427	6264600005	MERCEDES BUS	16-7
0507192	4626261	IVECO TRUCK	5-23	0507428	4103300205	MERCEDES BUS	16-5
0507202	5000395296	RENAULT V.I.	9-4	0507429	6273300303	MERCEDES BUS	16-1
0507204	81466106648	MAN BUS	15-5	0507430	6284600305	MERCEDES BUS	16-5
0507212	81466106606	MAN BUS	15-5	0507431	3574603505	MERCEDES BUS	16-7
0507214	81466106241	MAN	6-8	0507432	6284600205	MERCEDES BUS	16-7
0507215	85466106019	MAN	6-7	0507433	0003201232	MERCEDES BUS	16-1
0507216	81467106436	MAN	6-8	0507434	0034606005	MERCEDES	7-20
0507217	85461106141	MAN	6-5	0507435	3823300403	MERCEDES BUS	16-3
0507218	3853301303	MERCEDES	7-5	0507436	9493301003	MERCEDES	7-3
0507220	5010488146	RENAULT V.I.	9-8	0507437	3463303903	MERCEDES	7-3
0507221	20443062	VOLVO	11-25	0507438	3564600205	MERCEDES BUS	16-6
0507222	20497800	VOLVO	11-5	0507439	9724601405	MERCEDES	7-14
0507222	3112122	VOLVO BUS	20-2	0507440	0014605305	MERCEDES	7-11
0507223	3112273	VOLVO BUS	20-2	0507441	0014604905	MERCEDES	7-20
0507224	20497798	VOLVO	11-1	0507468	11019632	NEOPLAN BUS	17-1
0507224	3112050	VOLVO BUS	20-1	0507469	11019635	NEOPLAN BUS	17-2
0507242	305317	SCANIA	10-20	0507470	11019641	NEOPLAN BUS	17-3
0507243	1384896	SCANIA	10-20	0507471	120324500	NEOPLAN BUS	17-2
0507244	1127452	VOLVO	11-12	0507472	11019664	NEOPLAN BUS	17-3
0507245	1577081	VOLVO	11-5	0507473	120325800	NEOPLAN BUS	17-3
0507253	213123268	RENAULT V.I.	9-5	0507474	11019692	NEOPLAN BUS	17-1
0507284	42088124	IVECO TRUCK	5-15	0507477	11020274	NEOPLAN BUS	17-3
0507287	41005469	IVECO TRUCK	5-7	0507479	122351500	NEOPLAN BUS	17-4
0507288	41005309	IVECO TRUCK	5-4	0507480	11020285	NEOPLAN BUS	17-3
0507290	8564386	IVECO TRUCK	5-1	0507481	11020291	NEOPLAN BUS	17-1
0507293	41005475	IVECO TRUCK	5-11	0507482	11020292	NEOPLAN BUS	17-1
0507301	42035418	IVECO TRUCK	5-9	0507483	122352740	NEOPLAN BUS	17-1
0507302	42037032	IVECO TRUCK	5-2	0507492	0094037	DAF-LEYLAND DAF	3-6
0507303	42039631	IVECO TRUCK	5-14	0507494	0094053	DAF-LEYLAND DAF	3-7
0507306	42043295	IVECO TRUCK	5-6	0507495	0098726	DAF-LEYLAND DAF	3-6
0507309	42087846	IVECO TRUCK	5-13	0507533	85466106021	MAN	6-6
0507310	42078019	IVECO TRUCK	5-13	0507534	81467106314	MAN	6-2
0507312	42102633	IVECO TRUCK	5-2	0507534	81467106314	MAN BUS	15-2
0507314	42115532	IVECO TRUCK	5-15	0507537	85466106108	MAN	6-7
0507321	80003410	IVECO TRUCK	5-8	0507549	81466106706	MAN BUS	15-4
0507323	86012924	IVECO TRUCK	5-1	0507559	85466106007	MAN	6-7
0507335	98484091	IVECO TRUCK	5-36	0507581	81467106994	MAN	6-4
0507347	42023778	IVECO TRUCK	5-8	0507584	0024605305	MERCEDES	7-21
0507365	5801282537	IVECO TRUCK	5-12	0507587	0014601505	MERCEDES	7-11
0507366	41032608	IVECO TRUCK	5-2	0507590	6204602905	MERCEDES	7-16
0507367	500308895	IVECO TRUCK	5-9	0507591	6253301503	MERCEDES	7-4
0507368	504049893	IVECO TRUCK	5-10	0507592	6174602005	MERCEDES	7-15
0507369	500397738	IVECO TRUCK	5-12	0507593	6203300003	MERCEDES	7-6
0507370	41215165	IVECO TRUCK	5-12	0507594	0014600305	MERCEDES	7-13
0507371	8166702	IVECO TRUCK	5-15	0507600	3563300003	MERCEDES BUS	16-2
0507405	81467106926	MAN	6-1	0507603	9493300603	MERCEDES	7-6
0507406	81466106656	MAN	6-10	0507604	9493300403	MERCEDES	7-6
0507407	81467106453	MAN BUS	15-1	0507605	3583300103	MERCEDES	7-5
0507408	81466106809	MAN	6-8	0507606	3134600005	MERCEDES BUS	16-4
0507409	81466116003	MAN	6-10	0507607	3524603705	MERCEDES	7-10
0507410	36466106012	MAN BUS	15-5	0507608	6674601605	MERCEDES	7-9
0507421	6273300103	MERCEDES BUS	16-1	0507608	6674601605	VEICOLI COMMERCIALI - LCV VEHICLE	1-49
0507422	3574602405	MERCEDES BUS	16-6				
0507423	6273300203	MERCEDES BUS	16-1	0507610	3913300603	MERCEDES	7-1
0507424	6344600505	MERCEDES BUS	16-1	0507611	4244600305	MERCEDES	7-17
0507425	4103300303	MERCEDES BUS	16-1	0507612	4254600105	MERCEDES	7-22

Cross Reference Guide

RIF. OCAP REF. OCAP	RIF. ORIG O.E. NUMBER	MARCA	PAG.	RIF. OCAP REF. OCAP	RIF. ORIG O.E. NUMBER	MARCA	PAG.
0507613	9704600705	MERCEDES	7-14	0507666	6174603505	MERCEDES	7-16
0507614	0024609605	MERCEDES	7-14	0507667	3024600305	MERCEDES	7-22
0507615	0024604905	MERCEDES	7-20	0507669	3463303903	MERCEDES	7-3
0507616	3573300203	MERCEDES BUS	16-3	0507670	6204602405	MERCEDES	7-21
0507617	4054600005	MERCEDES	7-11	0507671	3874601505	MERCEDES	7-15
0507618	4243300303	MERCEDES	7-1	0507673	5010130451	RENAULT V.I.	9-9
0507619	3053300403	MERCEDES BUS	16-3	0507674	5000725268	RENAULT V.I.	9-8
0507620	3273300103	MERCEDES	7-5	0507677	0023123268	RENAULT V.I.	9-6
0507621	3524602305	MERCEDES	7-10	0507678	5000761671	RENAULT V.I. BUS	18-2
0507624	6704602805	MERCEDES	7-8	0507679	1134840	VOLVO	11-12
0507624	6704602805	MERCEDES BUS	16-4	0507680	1194824	VOLVO	11-6
0507624	6704602805	VEICOLI COMMERCIALI - LCV VEHICLE	1-45	0507681	6790474	VOLVO	11-9
0507625	3164600605	MERCEDES	7-9	0507683	8132373	VOLVO	11-12
0507626	6174600005	MERCEDES	7-16	0507685	81466106375	MAN BUS	15-5
0507627	0004609805	MERCEDES	7-21	0507685	3574602005	MERCEDES BUS	16-7
0507628	0004604405	MERCEDES	7-23	0507686	20490120	VOLVO BUS	20-2
0507629	0004609205	MERCEDES	7-17	0507688	1075663	VOLVO	11-8
0507630	0024604305	MERCEDES	7-18	0507692	1197338	VOLVO BUS	20-2
0507631	0024604705	MERCEDES	7-17	0507693	1083744	VOLVO	11-7
0507632	0014609805	MERCEDES	7-16	0507694	0004604105	MERCEDES	7-24
0507633	0014600005	MERCEDES	7-7	0507695	0004602705	MERCEDES	7-14
0507636	4253300003	MERCEDES	7-1	0507696	3834600705	MERCEDES	7-19
0507637	0024607705	MERCEDES	7-22	0507697	3914600905	MERCEDES	7-24
0507639	6764601905	MERCEDES	7-13	0507698	6224600205	MERCEDES	7-10
0507640	6254602505	MERCEDES	7-17	0507700	6254601405	MERCEDES	7-24
0507641	0004606605	MERCEDES	7-23	0507701	6764600205	MERCEDES	7-13
0507642	0034601805	MERCEDES	7-19	0507702	1088985	VOLVO	11-4
0507643	9413300103	MERCEDES	7-6	0507703	1612779	VOLVO	11-13
0507644	3573300803	MERCEDES BUS	16-3	0507704	1612857	VOLVO	11-13
0507645	3574601405	MERCEDES BUS	16-6	0507705	1612858	VOLVO	11-13
0507647	3433300103	MERCEDES	7-2	0507706	1130567	VOLVO	11-4
0507651	9453300203	MERCEDES	7-1	0507707	6771112	VOLVO	11-12
0507652	3093301203	MERCEDES	7-24	0507708	1080792	VOLVO	11-2
0507652	3093301203	MERCEDES BUS	16-7	0507709	6853511	VOLVO	11-1
0507653	6703300003	MERCEDES	7-3	0507710	6852197	VOLVO	11-11
0507653	6703300203	MERCEDES BUS	16-2	0507712	6876948	VOLVO	11-9
0507653	6693300403	VEICOLI COMMERCIALI - LCV VEHICLE	1-47	0507713	6866174	VOLVO	11-4
0507654	3023300303	MERCEDES BUS	16-3	0507714	6866175	VOLVO	11-4
0507655	3523301603	MERCEDES	7-4	0507715	20400907	VOLVO	11-12
0507656	6684601705	MERCEDES	7-9	0507716	1571862	VOLVO	11-1
0507656	6684601505	VEICOLI COMMERCIALI - LCV VEHICLE	1-46	0507717	6790473	VOLVO	11-9
0507657	3853300503	MERCEDES	7-4	0507718	1611880	VOLVO	11-7
0507657	3853301403	MERCEDES BUS	16-2	0507719	1194390	VOLVO	11-2
0507658	3503307203	MERCEDES	7-4	0507720	1094334	VOLVO	11-5
0507659	6704602605	MERCEDES	7-8	0507723	1361413	SCANIA	10-8
0507659	6704602605	MERCEDES BUS	16-4	0507725	0310977	SCANIA	10-2
0507659	6704602605	VEICOLI COMMERCIALI - LCV VEHICLE	1-45	0507726	1394884	SCANIA	10-3
0507660	6684600505	MERCEDES	7-9	0507727	0382780	SCANIA	10-3
0507660	6684600505	VEICOLI COMMERCIALI - LCV VEHICLE	1-46	0507728	0389867	SCANIA	10-4
0507661	3024600505	MERCEDES	7-10	0507729	1112023	SCANIA	10-5
0507662	3524602105	MERCEDES	7-10	0507730	0415400	SCANIA BUS	19-1
0507663	3524603005	MERCEDES	7-10	0507731	1384027	SCANIA	10-7
0507664	3434600405	MERCEDES	7-12	0507732	0388942	SCANIA	10-8
0507665	3354600005	MERCEDES	7-12	0507733	1367628	SCANIA	10-8
				0507734	1367641	SCANIA	10-8
				0507735	1304569	SCANIA	10-6
				0507737	1305012	SCANIA	10-4
				0507740	5010130383	RENAULT V.I.	9-4

Cross Reference Guide

RIF. OCAP REF. OCAP	RIF. ORIG O.E. NUMBER	MARCA	PAG.	RIF. OCAP REF. OCAP	RIF. ORIG O.E. NUMBER	MARCA	PAG.
0507741	5430119888	RENAULT V.I.	9-4	0507818	81466106301	MAN	6-5
0507742	81467106459	MAN BUS	15-3	0507818	81466106305	MAN BUS	15-4
0507742	3573300603	MERCEDES BUS	16-3	0507819	81467106434	MAN	6-1
0507743	81467116770	MAN BUS	15-1	0507820	81466106790	MAN	6-10
0507743	81467116770	NEOPLAN BUS	17-1	0507821	81466106160	MAN	6-7
0507744	5000786768	RENAULT V.I. BUS	18-2	0507822	81466106779	MAN	6-10
0507755	5010064715	RENAULT V.I.	9-5	0507823	81466106578	MAN	6-5
0507758	412406	SCANIA BUS	19-1	0507824	81467106862	MAN BUS	15-2
0507764	421573	SCANIA	10-7	0507825	6174600105	MERCEDES	7-16
0507765	5010130710	RENAULT V.I.	9-9	0507826	6684602305	MERCEDES	7-8
0507766	1343283	SCANIA	10-3	0507826	6684602305	VEICOLI COMMERCIALI - LCV VEHICLE	1-45
0507767	1343266	SCANIA	10-3				
0507768	6852196	VOLVO	11-11	0507827	0034605905	MERCEDES	7-20
0507769	6852195	VOLVO	11-11	0507828	6734600305	MERCEDES	7-11
0507771	1507260	SCANIA	10-7	0507829	0014604205	MERCEDES	7-21
0507772	412405	SCANIA	10-5	0507830	6704600805	VEICOLI COMMERCIALI - LCV VEHICLE	1-46
0507775	0388941	SCANIA	10-3				
0507776	283768	SCANIA	10-1	0507831	6674600705	VEICOLI COMMERCIALI - LCV VEHICLE	1-47
0507777	283766	SCANIA	10-2				
0507778	395346	SCANIA	10-1	0507832	81467106086	MAN	6-1
0507779	1363964	SCANIA	10-1	0507833	81467106118	MAN	6-2
0507780	388943	SCANIA	10-1	0507835	81467106236	MAN	6-4
0507781	1300284	SCANIA	10-4	0507839	81466106004	MAN	6-6
0507782	1305012	SCANIA	10-5	0507840	81467106395	MAN	6-3
0507784	1257991	DAF-LEYLAND DAF	3-4	0507840	81467106395	MAN BUS	15-2
0507786	3163300203	MERCEDES	7-1	0507841	81467106865	MAN	6-3
0507786	3163300203	MERCEDES BUS	16-2	0507842	85466106012	MAN	6-6
0507787	6754601405	MERCEDES	7-12	0507843	81467106933	MAN	6-3
0507788	6763300103	MERCEDES	7-2	0507844	81466106167	MAN	6-6
0507789	0024604505	MERCEDES	7-21	0507845	81467106438	MAN	6-1
0507790	6763300203	MERCEDES	7-2	0507846	81467106442	MAN	6-1
0507790	6763300203	MERCEDES BUS	16-2	0507847	81467106118	MAN	6-2
0507791	81466106795	MAN BUS	15-4	0507848	81466106579	MAN	6-2
0507791	81466116045	NEOPLAN BUS	17-3	0507848	81466106579	MAN BUS	15-2
0507792	6763300303	MERCEDES	7-1	0507849	5010098467	RENAULT V.I.	9-3
0507792	673300503	MERCEDES BUS	16-2	0507850	98473328	IVECO BUS	14-2
0507793	3853300203	MERCEDES	7-5	0507850	98473328	IVECO TRUCK	5-12
0507794	6764603105	MERCEDES	7-13	0507851	98493054	IVECO TRUCK	5-9
0507795	6173300203	MERCEDES	7-4	0507852	500362533	IVECO BUS	14-3
0507798	0890991	DAF-LEYLAND DAF	3-3	0507852	500362533	IVECO TRUCK	5-14
0507799	0094613	DAF-LEYLAND DAF	3-6	0507853	500363545	IVECO BUS	14-2
0507800	0275962	DAF-LEYLAND DAF	3-1	0507853	500363545	IVECO TRUCK	5-14
0507802	20400942	VOLVO	11-10	0507854	5010294720	RENAULT V.I.	9-6
0507804	0014609705	MERCEDES	7-15	0507854	5010294720	RENAULT V.I.	9-6
0507805	6204600105	MERCEDES	7-18	0507855	5010566059	RENAULT V.I.	9-3
0507806	81467106081	MAN BUS	15-1	0507856	5010439022	RENAULT V.I.	9-3
0507807	81467106112	MAN	6-4	0507858	5010439021	RENAULT V.I.	9-3
0507808	81467106131	MAN	6-3	0507859	500324282	IVECO TRUCK	5-6
0507809	81466106711	MAN BUS	15-4	0507860	8137594	IVECO TRUCK	5-4
0507810	81466106603	MAN	6-10	0507861	5010488164	RENAULT V.I.	9-7
0507811	81467106902	MAN BUS	15-2	0507862	5010488165	RENAULT V.I.	9-7
0507812	85466106160	MAN	6-7	0507863	5010305367	RENAULT V.I.	9-8
0507813	85466106247	MAN	6-7	0507864	5010566049	RENAULT V.I.	9-1
0507814	81467116803	MAN	6-3	0507865	5010291903	RENAULT V.I.	9-2
0507815	81466106692	MAN	6-8	0507866	504034521	IVECO TRUCK	5-15
0507816	81467106238	MAN	6-1	0507884	5010488464	RENAULT V.I.	9-4
0507817	81467106122	MAN	6-2	0507886	9423300303	MERCEDES	7-6
0507817	81467106912	MAN BUS	15-2	0507887	0034604605	MERCEDES	7-20
				0507888	5010199642	IVECO BUS	14-10
				0507888	5010199642	RENAULT V.I. BUS	18-7



Cross Reference Guide

RIF. OCAP REF. OCAP	RIF. ORIG O.E. NUMBER	MARCA	PAG.	RIF. OCAP REF. OCAP	RIF. ORIG O.E. NUMBER	MARCA	PAG.
0507894	81467116715	MAN BUS	15-3	0507966	0014605705	MERCEDES	7-12
0507895	1599175	VOLVO	11-13	0507967	0004609505	MERCEDES	7-21
0507898	6704600905	MERCEDES	7-9	0507968	0014600705	MERCEDES	7-19
0507898	6704600905	MERCEDES BUS	16-4	0507969	9443300503	MERCEDES	7-2
0507898	6704600905	VEICOLI COMMERCIALI - LCV VEHICLE	1-47	0507970	0004601005	MERCEDES	7-13
0507904	41028269	IVECO TRUCK	5-9	0507971	0004606005	MERCEDES	7-10
0507905	6674601505	VEICOLI COMMERCIALI - LCV VEHICLE	1-49	0507972	9574600505	MERCEDES	7-14
0507910	6253300903	MERCEDES	7-2	0507973	0024601705	MERCEDES	7-19
0507911	0014601305	MERCEDES	7-23	0507974	0024609205	MERCEDES	7-22
0507912	0024605105	MERCEDES	7-18	0507975	9753300203	MERCEDES	7-3
0507915	81467116773	MAN	6-4	0507975	20830369	VOLVO	11-1
0507916	9453300003	MERCEDES	7-6	0507976	4064600105	MERCEDES	7-23
0507917	81466106807	MAN	6-9	0507977	0004608505	MERCEDES	7-24
0507924	0087932	BREDAMENARINIBUS	12-1	0507978	0014606505	MERCEDES	7-13
0507924	0087932	DAF-LEYLAND DAF	3-3	0507979	9423300403	MERCEDES	7-5
0507924	0087932	SCANIA	10-4	0507985	5010383097	RENAULT V.I.	9-7
0507928	1401940	DAF-LEYLAND DAF	3-5	0507986	0000755676	RENAULT V.I. BUS	18-1
0507930	1143319	DAF-LEYLAND DAF	3-3	0507987	5010308215	RENAULT V.I.	9-2
0507931	1295415	DAF-LEYLAND DAF	3-2	0507988	5010383529	RENAULT V.I.	9-8
0507932	1311048	DAF-LEYLAND DAF	3-6	0507989	5000761673	RENAULT V.I. BUS	18-1
0507933	1270853	DAF-LEYLAND DAF	3-2	0507993	5000869763	RENAULT V.I. BUS	18-7
0507934	0288281	DAF-LEYLAND DAF	3-2	0507995	1479122	SCANIA BUS	19-2
0507935	1363858	DAF-LEYLAND DAF	3-4	0507996	1450364	SCANIA BUS	19-1
0507936	1392640	DAF-LEYLAND DAF	3-7	0507998	0466336	SCANIA BUS	19-1
0507937	1451118	DAF-LEYLAND DAF	3-4	0507999	1343262	SCANIA	10-3
0507938	1380417	DAF-LEYLAND DAF	3-4	0509879	1343264	SCANIA	10-8
0507939	0593883	DAF-LEYLAND DAF	3-3	0509880	0466880	SCANIA BUS	19-2
0507940	1315530	DAF-LEYLAND DAF	3-7	0509881	1348269	SCANIA	10-7
0507941	1346489	DAF-LEYLAND DAF	3-7	0509882	1197339	SCANIA BUS	19-1
0507942	1297572	DAF-LEYLAND DAF	3-1	0509882	1197339	VOLVO BUS	20-2
0507943	1143322	DAF-LEYLAND DAF	3-5	0509884	1343278	SCANIA	10-8
0507944	1257992	DAF-LEYLAND DAF	3-3	0509885	1733471	SCANIA	10-8
0507945	0094044	DAF-LEYLAND DAF	3-6	0509886	1766014	SCANIA	10-19
0507946	1143324	DAF-LEYLAND DAF	3-7	0509886	1766014	SCANIA BUS	19-7
0507947	1395994	DAF-LEYLAND DAF	3-5	0509889	1766015	SCANIA BUS	19-7
0507948	1363859	DAF-LEYLAND DAF	3-4	0509890	1455327	SCANIA BUS	19-7
0507949	1700000	DAF-LEYLAND DAF	3-1	0509891	1628635	VOLVO	11-9
0507950	81467106080	MAN BUS	15-1	0509892	3098294	VOLVO BUS	20-2
0507951	81466106811	MAN	6-9	0509893	1094219	VOLVO	11-5
0507952	36466106007	MAN BUS	15-5	0509894	20399543	VOLVO	11-3
0507952	36466106007	NEOPLAN BUS	17-4	0509895	20375556	VOLVO	11-8
0507953	85466106026	MAN	6-9	0509896	1606897	VOLVO	11-2
0507954	81467116886	MAN BUS	15-1	0509897	20375555	VOLVO	11-8
0507954	81467116886	NEOPLAN BUS	17-1	0509898	20393091	VOLVO	11-13
0507955	81466106374	MAN	6-9	0509899	3039647	VOLVO BUS	20-2
0507955	81466106374	MAN BUS	15-4	0509900	8156123	VOLVO	11-2
0507956	85466106018	MAN	6-8	0509900	8156123	VOLVO BUS	20-1
0507957	81467116771	MAN BUS	15-1	0509901	3116050	VOLVO BUS	20-3
0507958	81466106159	MAN	6-5	0509902	6799190	VOLVO	11-11
0507960	6684602105	MERCEDES	7-9	0509904	1196631	VOLVO BUS	20-7
0507960	6684602105	VEICOLI COMMERCIALI - LCV VEHICLE	1-45	0509905	3173613	VOLVO	11-25
0507961	0014601105	MERCEDES	7-11	0509906	3112282	VOLVO BUS	20-7
0507962	0024606105	MERCEDES	7-22	0509910	20713859	RENAULT V.I.	9-2
0507963	0034600705	MERCEDES	7-20	0509911	7422163637	RENAULT V.I.	9-2
0507964	0014605505	MERCEDES	7-23	0509911	22163637	VOLVO	11-3
0507965	0024605905	MERCEDES	7-22	0509912	1164684	RENAULT V.I.	9-1
				0509913	488738	SCANIA BUS	19-7
				0509914	20581086	VOLVO	11-2

Cross Reference Guide

RIF. OCAP REF. OCAP	RIF. ORIG O.E. NUMBER	MARCA	PAG.	RIF. OCAP REF. OCAP	RIF. ORIG O.E. NUMBER	MARCA	PAG.
0509915	21119064	VOLVO	11-25	0594262	6393200089	VEICOLI COMMERCIALI - LCV VEHICLE	1-54
0509916	21260274	VOLVO	11-1				
0509918	504126384	IVECO BUS	14-1	0594333	7H0419803D	VEICOLI COMMERCIALI - LCV VEHICLE	1-101
0509920	81466106708	MAN BUS	15-4	0595068	542180023	VEICOLI COMMERCIALI - LCV VEHICLE	1-35
0581405	701419804C	VEICOLI COMMERCIALI - LCV VEHICLE	1-95	0596419	4822291	IVECO BUS	14-1
0581406	702419804A	VEICOLI COMMERCIALI - LCV VEHICLE	1-95	0597871	500383976	VEICOLI COMMERCIALI - LCV VEHICLE	1-33
0581407	701419804D	VEICOLI COMMERCIALI - LCV VEHICLE	1-95	0597980	6283201089	MERCEDES BUS	16-20
0581411	701419804E	VEICOLI COMMERCIALI - LCV VEHICLE	1-98	0597981	6283201389	MERCEDES BUS	16-20
0581412	702419804C	VEICOLI COMMERCIALI - LCV VEHICLE	1-98	0597982	6283200089	MERCEDES BUS	16-20
0581413	701419804F	VEICOLI COMMERCIALI - LCV VEHICLE	1-98	0597983	6283200189	MERCEDES BUS	16-20
0581514	2D0411052	VEICOLI COMMERCIALI - LCV VEHICLE	1-39	0597990	5000450714	RENAULT V.I.	9-24
0581907	6383230368	VEICOLI COMMERCIALI - LCV VEHICLE	1-52	0597991	5010238594	RENAULT V.I.	9-24
0582743	9063201889	VEICOLI COMMERCIALI - LCV VEHICLE	1-41	0597992	5000786379	RENAULT V.I. BUS	18-7
0583812	4500199	VEICOLI COMMERCIALI - LCV VEHICLE	1-56	0599888	1506925	SCANIA BUS	19-7
0584163	6383230568	VEICOLI COMMERCIALI - LCV VEHICLE	1-52	0599922	5006306003	IVECO BUS	14-10
0584262	6393200189	VEICOLI COMMERCIALI - LCV VEHICLE	1-54	0600514	9750390080	VEICOLI COMMERCIALI - LCV VEHICLE	1-11
0584333	7H0419804D	VEICOLI COMMERCIALI - LCV VEHICLE	1-101	0600516	9983325	VEICOLI COMMERCIALI - LCV VEHICLE	1-31
0585068	542180024	VEICOLI COMMERCIALI - LCV VEHICLE	1-35	0600887	-	VEICOLI COMMERCIALI - LCV VEHICLE	1-93
0586419	4826513	IVECO BUS	14-1	0600918	3812A4	VEICOLI COMMERCIALI - LCV VEHICLE	1-7
0587871	500383975	VEICOLI COMMERCIALI - LCV VEHICLE	1-33	0601139	1471654080	VEICOLI COMMERCIALI - LCV VEHICLE	1-1
0587980	6283201189	MERCEDES BUS	16-20	0601406	-	VEICOLI COMMERCIALI - LCV VEHICLE	1-96
0587981	6283201389	MERCEDES BUS	16-20	0601412	-	VEICOLI COMMERCIALI - LCV VEHICLE	1-96
0587982	6283200289	MERCEDES BUS	16-20	0601496-K	7701470362	VEICOLI COMMERCIALI - LCV VEHICLE	1-77
0587983	6283200389	MERCEDES BUS	16-20	0601504	2D0422803	VEICOLI COMMERCIALI - LCV VEHICLE	1-38
0587990	5000450713	RENAULT V.I.	9-24	0601536	4420096 Z	VEICOLI COMMERCIALI - LCV VEHICLE	1-59
0587991	5010253256	RENAULT V.I.	9-24	0601726	68699511	VEICOLI COMMERCIALI - LCV VEHICLE	1-24
0587992	5000869761	RENAULT V.I. BUS	18-7	0601905	6384600255	VEICOLI COMMERCIALI - LCV VEHICLE	1-51
0589888	1506924	SCANIA BUS	19-7	0602230	-	VEICOLI COMMERCIALI - LCV VEHICLE	1-81
0589922	5006306002	IVECO BUS	14-10	0602231	-	VEICOLI COMMERCIALI - LCV VEHICLE	1-81
0591405	701419803C	VEICOLI COMMERCIALI - LCV VEHICLE	1-95	0602637	1341019080 *	VEICOLI COMMERCIALI - LCV VEHICLE	1-5
0591406	702419803A	VEICOLI COMMERCIALI - LCV VEHICLE	1-95	0602733	1401381380	VEICOLI COMMERCIALI - LCV VEHICLE	1-9
0591407	701419803D	VEICOLI COMMERCIALI - LCV VEHICLE	1-95	0602741	-	VEICOLI COMMERCIALI - LCV VEHICLE	1-40
0591411	701419803E	VEICOLI COMMERCIALI - LCV VEHICLE	1-98	0602741-K	9064600055	VEICOLI COMMERCIALI - LCV VEHICLE	1-40
0591412	702419803C	VEICOLI COMMERCIALI - LCV VEHICLE	1-98	0602749	2992593	VEICOLI COMMERCIALI - LCV VEHICLE	1-34
0591413	702419803D	VEICOLI COMMERCIALI - LCV VEHICLE	1-99	0603811	-	VEICOLI COMMERCIALI - LCV VEHICLE	1-55
0591514	2D0411051	VEICOLI COMMERCIALI - LCV VEHICLE	1-39	0603811-K	4501261	VEICOLI COMMERCIALI - LCV VEHICLE	1-57
0591907	6383230268	VEICOLI COMMERCIALI - LCV VEHICLE	1-52	0603867	1763991	VEICOLI COMMERCIALI - LCV VEHICLE	1-29
0592743	9063201789	VEICOLI COMMERCIALI - LCV VEHICLE	1-41	0604250	-	VEICOLI COMMERCIALI - LCV VEHICLE	1-53
0593812	4500198	VEICOLI COMMERCIALI - LCV VEHICLE	1-56	0604250-K	6394600055	VEICOLI COMMERCIALI - LCV VEHICLE	1-53
0594163	6383230468	VEICOLI COMMERCIALI - LCV VEHICLE	1-52	0604334	-	VEICOLI COMMERCIALI - LCV VEHICLE	1-101

Cross Reference Guide

RIF. OCAP REF. OCAP	RIF. ORIG O.E. NUMBER	MARCA	PAG.	RIF. OCAP REF. OCAP	RIF. ORIG O.E. NUMBER	MARCA	PAG.
0604424	4408474 *	VEICOLI COMMERCIALI - LCV VEHICLE	1-61	0807213	98488010	IVECO TRUCK	5-21
0604424-K	4408474	VEICOLI COMMERCIALI - LCV VEHICLE	1-61	0807214	81432206010	MAN	6-15
0606927	-	VEICOLI COMMERCIALI - LCV VEHICLE	1-31	0807216	81432306037	MAN	6-15
0607191	41210795	IVECO TRUCK	5-38	0807218	3833500105	MERCEDES	7-41
0607254	42072495	IVECO TRUCK	5-38	0807219	5010094840	RENAULT V.I.	9-19
0607552	42532977	VEICOLI COMMERCIALI - LCV VEHICLE	1-34	0807221	1080690	VOLVO	11-18
0683868	4059924	VEICOLI COMMERCIALI - LCV VEHICLE	1-26	0807222	1082104	VOLVO	11-20
0693868	4059923	VEICOLI COMMERCIALI - LCV VEHICLE	1-26	0807252	0023123253	RENAULT V.I.	9-18
0781505	2D0407022	VEICOLI COMMERCIALI - LCV VEHICLE	1-38	0807257	4716799	IVECO TRUCK	5-26
0781906	6383300110	VEICOLI COMMERCIALI - LCV VEHICLE	1-51	0807262	42000481	IVECO TRUCK	5-23
0782742	2E0407152M	VEICOLI COMMERCIALI - LCV VEHICLE	1-40	0807282	4463926	IVECO TRUCK	5-25
0782751	6608830	VEICOLI COMMERCIALI - LCV VEHICLE	1-24	0807283	4719609	IVECO TRUCK	5-30
0783808	4408959	VEICOLI COMMERCIALI - LCV VEHICLE	1-61	0807286	4855237	IVECO TRUCK	5-30
0783867	1371231	VEICOLI COMMERCIALI - LCV VEHICLE	1-27	0807292	41003268	IVECO TRUCK	5-22
0783868	1877332	VEICOLI COMMERCIALI - LCV VEHICLE	1-29	0807295	41011006	IVECO TRUCK	5-23
0783869	4042022	VEICOLI COMMERCIALI - LCV VEHICLE	1-27	0807296	41022092	IVECO TRUCK	5-27
0783870	1903526	VEICOLI COMMERCIALI - LCV VEHICLE	1-30	0807298	42000486	IVECO TRUCK	5-24
0784260	6393300510	VEICOLI COMMERCIALI - LCV VEHICLE	1-53	0807299	41042093	IVECO TRUCK	5-29
0787249	42551297	VEICOLI COMMERCIALI - LCV VEHICLE	1-32	0807308	42086282	IVECO TRUCK	5-29
0787250	42551290	VEICOLI COMMERCIALI - LCV VEHICLE	1-32	0807326	93165049	IVECO TRUCK	5-24
0791505	2D0407021	VEICOLI COMMERCIALI - LCV VEHICLE	1-39	0807328	97104299	IVECO TRUCK	5-31
0791906	6383300010	VEICOLI COMMERCIALI - LCV VEHICLE	1-52	0807336	98472871	IVECO TRUCK	5-22
0792742	9063304007	VEICOLI COMMERCIALI - LCV VEHICLE	1-41	0807339	99432565	IVECO BUS	14-6
0792751	6608832	VEICOLI COMMERCIALI - LCV VEHICLE	1-25	0807354	082750900	NEOPLAN BUS	17-8
0793808	4408958	VEICOLI COMMERCIALI - LCV VEHICLE	1-62	0807357	082751110	NEOPLAN BUS	17-8
0793867	1371228	VEICOLI COMMERCIALI - LCV VEHICLE	1-27	0807358	41009661	IVECO TRUCK	5-22
0793868	1877334	VEICOLI COMMERCIALI - LCV VEHICLE	1-29	0807363	41218021	IVECO TRUCK	5-21
0793869	4042023	VEICOLI COMMERCIALI - LCV VEHICLE	1-27	0807372	41218621	IVECO TRUCK	5-28
0793870	1903527	VEICOLI COMMERCIALI - LCV VEHICLE	1-30	0807373	41272706	IVECO TRUCK	5-28
0794260	6393300410	VEICOLI COMMERCIALI - LCV VEHICLE	1-53	0807374	41296730	IVECO TRUCK	5-24
0797249	42551296	VEICOLI COMMERCIALI - LCV VEHICLE	1-32	0807407	81432206236	MAN	6-16
0797250	42551289	VEICOLI COMMERCIALI - LCV VEHICLE	1-32	0807408	81432206144	MAN BUS	15-9
0807207	4714134	IVECO TRUCK	5-21	0807408	81432206189	NEOPLAN BUS	17-9
0807208	4716271	IVECO TRUCK	5-25	0807409	81432206112	MAN BUS	15-9
0807209	42125057	IVECO TRUCK	5-21	0807410	81432206187	MAN BUS	15-9
0807210	4738069	IVECO BUS	14-6	0807411	6293500006	MERCEDES BUS	16-15
0807211	41002770	IVECO TRUCK	5-28	0807412	4103500906	MERCEDES BUS	16-12
0807213	98488010	IVECO BUS	14-6	0807413	6273500006	MERCEDES BUS	16-13
				0807414	3563300211	MERCEDES BUS	16-15
				0807415	8226318000B	MERCEDES BUS	16-14
				0807416	6273500106	MERCEDES BUS	16-14
				0807417	3173500706	MERCEDES BUS	16-14
				0807418	3173500606	MERCEDES BUS	16-12
				0807419	3223301011	MERCEDES BUS	16-15
				0807420	6293520005	MERCEDES BUS	16-14
				0807451	0477889	SCANIA BUS	19-4
				0807452	1438475	SCANIA BUS	19-4
				0807453	463435	SCANIA BUS	19-5
				0807454	1326771	SCANIA	10-11
				0807455	1796671	SCANIA BUS	19-4
				0807464	082756320	NEOPLAN BUS	17-9
				0807478	122351400	NEOPLAN BUS	17-8
				0807489	0080521	DAF-LEYLAND DAF	3-15
				0807501	0267743	DAF-LEYLAND DAF	3-15
				0807507	0296110	DAF-LEYLAND DAF	3-16
				0807509	0368541	DAF-LEYLAND DAF	3-17
				0807513	0392418	DAF-LEYLAND DAF	3-16
				0807525	0649819	DAF-LEYLAND DAF	3-17

Cross Reference Guide

RIF. OCAP REF. OCAP	RIF. ORIG O.E. NUMBER	MARCA	PAG.	RIF. OCAP REF. OCAP	RIF. ORIG O.E. NUMBER	MARCA	PAG.
0807528	0658102	DAF-LEYLAND DAF	3-16	0807690	1626957	VOLVO	11-17
0807529	1576953	VOLVO	11-21	0807691	1629668	VOLVO	11-17
0807531	3573330101	MERCEDES BUS	16-16	0807738	417290	SCANIA	10-11
0807533	81432706030	MAN	6-18	0807745	0023123251	RENAULT V.I.	9-16
0807542	3573330605	MERCEDES BUS	16-15	0807749	5010207771	RENAULT V.I.	9-16
0807544	1606552	VOLVO	11-18	0807750	5010347099	RENAULT V.I. BUS	18-4
0807551	5000027957	RENAULT V.I.	9-18	0807752	5010005937	RENAULT V.I.	9-16
0807554	465816	SCANIA	10-12	0807753	5000869572	RENAULT V.I.	9-17
0807555	1261101	DAF-LEYLAND DAF	3-14	0807756	5000869573	RENAULT V.I.	9-20
0807556	3813500206	MERCEDES	7-36	0807758	409639	SCANIA	10-13
0807559	81432206096	MAN	6-16	0807759	416800	SCANIA	10-13
0807579	42041107	IVECO TRUCK	5-24	0807760	414531	SCANIA	10-14
0807585	3813500606	MERCEDES	7-30	0807761	416524	SCANIA	10-11
0807586	3933200132	MERCEDES	7-34	0807762	7420829503	RENAULT V.I.	9-20
0807587	620350006	MERCEDES	7-36	0807762	1076639	VOLVO	11-20
0807589	41028599	IVECO TRUCK	5-27	0807770	3951306	VOLVO	11-17
0807590	6293500506	MERCEDES BUS	16-13	0807771	1338769	SCANIA	10-11
0807591	6283330205	MERCEDES BUS	16-13	0807772	445634	SCANIA	10-12
0807592	6283330305	MERCEDES BUS	16-14	0807773	445631	SCANIA	10-14
0807593	6283330405	MERCEDES BUS	16-12	0807774	3753500205	MERCEDES	7-40
0807594	3573330405	MERCEDES BUS	16-12	0807797	0646373	DAF-LEYLAND DAF	3-14
0807599	3753500505	MERCEDES	7-38	0807801	81432206213	MAN	6-21
0807600	3953500806	MERCEDES	7-37	0807806	81432206164	MAN BUS	15-8
0807601	3433201632	MERCEDES	7-35	0807806	81432206215	NEOPLAN BUS	17-9
0807602	3433201032	MERCEDES	7-35	0807807	81432206174	MAN	6-20
0807603	3813500306	MERCEDES	7-37	0807808	81432206145	MAN BUS	15-8
0807604	6193500206	MERCEDES	7-44	0807808	81432206145	NEOPLAN BUS	17-9
0807605	6593500124	MERCEDES	7-32	0807810	81432306038	MAN	6-22
0807606	3953200132	MERCEDES	7-31	0807811	81432206067	MAN	6-16
0807607	3953201532	MERCEDES	7-42	0807816	81432206177	MAN BUS	15-8
0807608	3853500106	MERCEDES	7-37	0807816	81432206177	NEOPLAN BUS	17-8
0807610	3953201432	MERCEDES	7-44	0807817	81432206222	MAN	6-22
0807611	3953500006	MERCEDES	7-31	0807818	81432206082	MAN	6-22
0807612	3953200206	MERCEDES	7-33	0807819	81432206248	MAN BUS	15-8
0807613	6243500306	MERCEDES	7-43	0807820	81432206247	MAN	6-15
0807614	3953500606	MERCEDES	7-37	0807821	81432206161	MAN	6-15
0807615	6593500427	MERCEDES	7-32	0807821	81432206161	MAN BUS	15-8
0807616	6243500106	MERCEDES	7-32	0807821	81432206161	NEOPLAN BUS	17-10
0807617	3953500706	MERCEDES	7-33	0807822	81432206099	MAN BUS	15-10
0807618	3953501306	MERCEDES	7-43	0807822	3573330205	MERCEDES BUS	16-15
0807619	6533500205	MERCEDES	7-40	0807823	81432206151	MAN BUS	15-8
0807634	9423501005	MERCEDES	7-39	0807823	81432206151	NEOPLAN BUS	17-10
0807635	9453300007	MERCEDES	7-45	0807824	81432206140	MAN	6-17
0807636	9413300007	MERCEDES	7-45	0807825	3933200332	MERCEDES	7-30
0807637	3433201632	MERCEDES	7-35	0807826	3893200732	MERCEDES	7-32
0807638	3523500306	MERCEDES	7-34	0807827	3893200832	MERCEDES	7-38
0807642	3853500006	MERCEDES	7-30	0807828	3933200232	MERCEDES	7-42
0807643	3953500206	MERCEDES	7-33	0807829	3953501006	MERCEDES	7-43
0807669	9453500105	MERCEDES	7-31	0807830	6243500406	MERCEDES	7-43
0807670	9453300011	MERCEDES	7-45	0807831	3953501106	MERCEDES	7-44
0807671	000360098524	MERCEDES	7-45	0807832	81432206258	MAN BUS	15-9
0807672	3563331304	MERCEDES BUS	16-13	0807832	81432206258	NEOPLAN BUS	17-10
0807673	5000640089	RENAULT V.I. BUS	18-4	0807833	81432206070	MAN	6-17
0807674	5010389262	RENAULT V.I.	9-17	0807839	81432706087	MAN	6-19
0807675	0023123275	RENAULT V.I.	9-17	0807840	81432206221	MAN	6-19
0807676	5010094839	RENAULT V.I.	9-18	0807841	81432706116	MAN	6-20
0807678	5010268035	RENAULT V.I.	9-18	0807842	81432706097	MAN	6-20
0807687	1581527	VOLVO	11-19	0807844	81433156036	MAN BUS	15-10



Cross Reference Guide

RIF. OCAP REF. OCAP	RIF. ORIG O.E. NUMBER	MARCA	PAG.	RIF. OCAP REF. OCAP	RIF. ORIG O.E. NUMBER	MARCA	PAG.
0807844	81433156036	NEOPLAN BUS	17-10	0907222	1598588	VOLVO	11-20
0807846	81432706053	MAN	6-21	0907224	1135080	VOLVO	11-20
0807847	81432706055	MAN	6-21	0907252	5010014345	RENAULT V.I.	9-17
0807867	6543500005	MERCEDES	7-41	0907257	0691704	DAF-LEYLAND DAF	3-20
0807882	3573500306	MERCEDES BUS	16-12	0907257	2968454	IVECO TRUCK	5-25
0807901	1431710	SCANIA BUS	19-4	0907257	082750905	NEOPLAN BUS	17-9
0807906	81432206196	MAN	6-17	0907257	271188	VOLVO	11-23
0807907	81432706117	MAN	6-18	0907258	1271124	DAF-LEYLAND DAF	3-14
0807908	9483502205	MERCEDES	7-38	0907258	2980884	IVECO TRUCK	5-22
0807913	7420741703	RENAULT V.I.	9-19	0907258	81432206108	MAN	6-16
0807914	20589061	VOLVO	11-21	0907259	0689749	DAF-LEYLAND DAF	3-16
0807918	20443061	VOLVO	11-17	0907259	2969844	IVECO BUS	14-6
0807927	1294251	DAF-LEYLAND DAF	3-15	0907259	2969844	IVECO TRUCK	5-21
0807930	1361652	DAF-LEYLAND DAF	3-18	0907259	81432206055	MAN	6-15
0807984	3753500105	MERCEDES	7-39	0907259	81432206055	MAN BUS	15-8
0807997	1353445	SCANIA	10-12	0907259	0003300611	MERCEDES BUS	16-12
0809879	489986	SCANIA BUS	19-5	0907259	070550504	NEOPLAN BUS	17-9
0809907	3172829	VOLVO	11-21	0907259	5001842823	RENAULT V.I.	9-18
0809908	1590068	VOLVO	11-19	0907259	5001842823	RENAULT V.I. BUS	18-4
0809909	1094466	VOLVO	11-19	0907259	1104335	SCANIA	10-11
0809921	5006305888	IVECO BUS	14-7	0907260	93194458	IVECO BUS	14-8
0809924	5006305892	IVECO BUS	14-6	0907262	2983125	IVECO TRUCK	5-23
0809925	5006305890	IVECO BUS	14-6	0907263	5000336305	RENAULT V.I.	9-27
0858054	542180020	VEICOLI COMMERCIALI - LCV VEHICLE	1-35	0907264	5000793641	RENAULT V.I.	9-28
0858055	5006306531	IVECO BUS	14-10	0907296	93161960	IVECO TRUCK	5-28
0900449	406635	VEICOLI COMMERCIALI - LCV VEHICLE	1-1	0907297	1376730	DAF-LEYLAND DAF	3-20
0900489	400622	VEICOLI COMMERCIALI - LCV VEHICLE	1-1	0907297	93161958	IVECO TRUCK	5-27
0901169	-	VEICOLI COMMERCIALI - LCV VEHICLE	1-11	0907297	3093469	VOLVO	11-23
0901504	2D0498831	VEICOLI COMMERCIALI - LCV VEHICLE	1-38	0907297	3093469	VOLVO BUS	20-6
0901527	-	VEICOLI COMMERCIALI - LCV VEHICLE	1-12	0907299	93161631	IVECO TRUCK	5-29
0901528	-	VEICOLI COMMERCIALI - LCV VEHICLE	1-12	0907304	0691703	DAF-LEYLAND DAF	3-21
0901536	4420096	VEICOLI COMMERCIALI - LCV VEHICLE	1-59	0907304	93192618	IVECO TRUCK	5-24
0902079	-	VEICOLI COMMERCIALI - LCV VEHICLE	1-93	0907304	0003500613	MERCEDES	7-30
0902230	-	VEICOLI COMMERCIALI - LCV VEHICLE	1-82	0907304	274068	VOLVO	11-18
0902231	-	VEICOLI COMMERCIALI - LCV VEHICLE	1-81	0907327	0067354	DAF-LEYLAND DAF	3-16
0902637	406686	VEICOLI COMMERCIALI - LCV VEHICLE	1-5	0907327	93192361	IVECO BUS	14-8
0902733	406683	VEICOLI COMMERCIALI - LCV VEHICLE	1-9	0907327	93192361	IVECO TRUCK	5-22
0902741	9064600096	VEICOLI COMMERCIALI - LCV VEHICLE	1-40	0907330	42493431	IVECO TRUCK	5-21
0902749	2992592	VEICOLI COMMERCIALI - LCV VEHICLE	1-34	0907330	81432706040	MAN	6-24
0903807	4408476	VEICOLI COMMERCIALI - LCV VEHICLE	1-61	0907330	81432706040	MAN BUS	15-11
0903811	4501260	VEICOLI COMMERCIALI - LCV VEHICLE	1-59	0907330	0003500413	MERCEDES	7-31
0907201	0003501505	MERCEDES	7-46	0907339	42535445	IVECO BUS	14-6
0907210	-	IVECO BUS	14-7	0907339	81432206213	MAN	6-21
0907216	81432306043	MAN	6-15	0907359	0513757	DAF-LEYLAND DAF	3-14
0907216	7701011267	RENAULT V.I.	9-21	0907359	273373	VOLVO	11-17
0907219	5001842337	RENAULT V.I.	9-17	0907362	42536819	IVECO BUS	14-8
				0907362	81432706127	MAN BUS	15-9
				0907362	0003500906	MERCEDES BUS	16-17
				0907362	42536819	NEOPLAN BUS	17-10
				0907405	1435944	SCANIA BUS	19-4
				0907405	81432206202	MAN	6-24
				0907405	550812	SCANIA	10-16
				0907405	550812	SCANIA BUS	19-5
				0907405	275988	VOLVO	11-23
				0907406	81432706065	MAN	6-21
				0907406	5001014520	RENAULT V.I.	9-22
				0907406	3133173	VOLVO	11-19
				0907407	500333284	IVECO TRUCK	5-33

Cross Reference Guide

RIF. OCAP REF. OCAP	RIF. ORIG O.E. NUMBER	MARCA	PAG.	RIF. OCAP REF. OCAP	RIF. ORIG O.E. NUMBER	MARCA	PAG.
0907407	85432206002	MAN	6-16	0907635	0003301411	MERCEDES	7-45
0907407	0003302011	MAN BUS	15-8	0907638	0005860132	MERCEDES	7-34
0907407	0003302011	MERCEDES BUS	16-17	0907672	0003501005	MERCEDES BUS	16-13
0907407	0003302011	NEOPLAN BUS	17-12	0907676	5001823280	RENAULT V.I.	9-19
0907409	81432206204	MAN BUS	15-9	0907677	5001823279	RENAULT V.I.	9-19
0907414	0003501305	MERCEDES BUS	16-15	0907678	5000802123	RENAULT V.I.	9-18
0907484	-	NEOPLAN BUS	17-8	0907683	81432706080	MAN	6-25
0907485	-	NEOPLAN BUS	17-9	0907683	276191	VOLVO	11-18
0907487	0069600	DAF-LEYLAND DAF	3-15	0907686	0696321	DAF-LEYLAND DAF	3-21
0907487	2968454	IVECO TRUCK	5-33	0907686	276192	MAN	6-21
0907487	271188	VOLVO	11-21	0907686	276192	VOLVO	11-18
0907489	0698724	DAF-LEYLAND DAF	3-15	0907739	5001842337 *	RENAULT V.I.	9-19
0907508	1208073	DAF-LEYLAND DAF	3-16	0907745	-	RENAULT V.I.	9-16
0907508	550807	SCANIA	10-12	0907746	-	RENAULT V.I.	9-16
0907525	0696320	DAF-LEYLAND DAF	3-17	0907747	-	RENAULT V.I.	9-16
0907528	0689748	DAF-LEYLAND DAF	3-17	0907748	-	RENAULT V.I.	9-16
0907528	81432306051	MAN	6-22	0907749	5000819365	RENAULT V.I.	9-16
0907528	81432306051	MAN BUS	15-11	0907757	-	IVECO TRUCK	5-22
0907528	0003300707	MERCEDES BUS	16-16	0907757	-	MAN	6-16
0907528	0639370	SCANIA	10-11	0907759	639299	SCANIA	10-13
0907528	0639370	SCANIA BUS	19-4	0907761	638870	SCANIA	10-11
0907528	271187	VOLVO	11-17	0907762	3090712	RENAULT V.I.	9-20
0907529	0696321	DAF-LEYLAND DAF	3-17	0907762	3090712	VOLVO	11-20
0907529	1104336	SCANIA	10-16	0907763	3093630	RENAULT V.I.	9-20
0907529	274056	VOLVO	11-21	0907763	3093631	VOLVO	11-20
0907531	0689747	DAF-LEYLAND DAF	3-16	0907770	81432506009	MAN	6-24
0907531	0003501013	MERCEDES	7-37	0907770	3090015	VOLVO	11-17
0907531	0003300107	MERCEDES BUS	16-16	0907773	638938	SCANIA	10-14
0907531	638861	SCANIA	10-13	0907774	0003502405	IVECO TRUCK	5-25
0907533	81953016132	MAN	6-18	0907774	0003502405	MAN	6-19
0907533	273706	VOLVO	11-21	0907774	0003502405	MERCEDES	7-40
0907534	81953016133	MAN	6-18	0907820	81432206322	MAN	6-15
0907534	273375	VOLVO	11-23	0907836	0005860732	MERCEDES	7-34
0907541	0003500113	MERCEDES	7-43	0907840	81432706118	MAN	6-19
0907545	274069	VOLVO	11-18	0907840	0003503305	MERCEDES	7-47
0907547	0003502705	MERCEDES	7-31	0907844	81433150009	MAN BUS	15-10
0907556	0693778	DAF-LEYLAND DAF	3-14	0907844	81433150009	NEOPLAN BUS	17-10
0907556	0003500213	MERCEDES	7-30	0907845	5001847026	MAN BUS	15-10
0907556	-	NEOPLAN BUS	17-8	0907845	5001847026	NEOPLAN BUS	17-11
0907578	93161371	IVECO TRUCK	5-21	0907846	1498132	MAN	6-22
0907583	42530929	IVECO BUS	14-8	0907882	0003300080	MERCEDES BUS	16-12
0907584	0003500105	MERCEDES	7-41	0907883	0003301611	MERCEDES BUS	16-12
0907586	0005861533	IVECO BUS	14-7	0907906	81432206250	MAN	6-17
0907586	0005861533	IVECO TRUCK	5-21	0907907	81432706105	MAN	6-18
0907586	0005861533	MERCEDES	7-30	0907908	0003503605	MERCEDES	7-38
0907586	0005861533	NEOPLAN BUS	17-8	0907909	0003503705	MERCEDES	7-38
0907591	0003302111	MERCEDES BUS	16-13	0907913	7420741710	RENAULT V.I.	9-19
0907595	5000819413	RENAULT V.I.	9-17	0907913	20741710	VOLVO	11-24
0907599	0003502505	MERCEDES	7-39	0907919	81432206241	MAN	6-17
0907601	0005861633	MERCEDES	7-34	0907919	7420547286	RENAULT V.I.	9-20
0907602	0005860632	MERCEDES	7-35	0907919	1515981	SCANIA	10-17
0907609	0003502205	MERCEDES	7-39	0907919	20547286	VOLVO	11-24
0907620	0003500205	MERCEDES	7-46	0907925	1445656	DAF-LEYLAND DAF	3-19
0907621	0005861035	MERCEDES	7-46	0907926	1398368	DAF-LEYLAND DAF	3-19
0907622	0003502105	MERCEDES	7-39	0907927	1321936	DAF-LEYLAND DAF	3-15
0907623	0003501905	MERCEDES	7-49	0907927	093163617	IVECO TRUCK	5-33
0907623	082751027	NEOPLAN BUS	17-13	0907927	0003300511	MERCEDES	7-47
0907634	0003502305	MERCEDES	7-39	0907984	0003502005	MERCEDES	7-39

Cross Reference Guide

RIF. OCAP REF. OCAP	RIF. ORIG O.E. NUMBER	MARCA	PAG.	RIF. OCAP REF. OCAP	RIF. ORIG O.E. NUMBER	MARCA	PAG.
0907997	1243618	DAF-LEYLAND DAF	3-20	1211073	61600701	VEICOLI COMMERCIALI - LCV VEHICLE	1-24
0907997	550808	SCANIA	10-12				
0909909	3090452	VOLVO	11-19	1211123	7700706007	VEICOLI COMMERCIALI - LCV VEHICLE	1-82
0927221	20751021	VOLVO	11-27				
0927398	0206137	DAF-LEYLAND DAF	3-23	1211128	7700680852	VEICOLI COMMERCIALI - LCV VEHICLE	1-81
0927399	0100873	DAF-LEYLAND DAF	3-23				
0927400	0548588	DAF-LEYLAND DAF	3-23	1211142	251419831A	VEICOLI COMMERCIALI - LCV VEHICLE	1-93
0927401	0118086	DAF-LEYLAND DAF	3-23				
0927402	0680374	DAF-LEYLAND DAF	3-23	1211165	6869950	VEICOLI COMMERCIALI - LCV VEHICLE	1-24
0927403	0681706	DAF-LEYLAND DAF	3-23				
0927404	0681511	DAF-LEYLAND DAF	3-24	1211267	7700774566	VEICOLI COMMERCIALI - LCV VEHICLE	1-81
0927406	81.44205.6009	MAN	6-27				
0927406	81.44204.0008	MAN BUS	15-13	1211310	4018A5	VEICOLI COMMERCIALI - LCV VEHICLE	1-1
0927408	81.44205.6013	MAN	6-27				
0927408	81.44205.6013	MAN BUS	15-13	1211392	4501260 Z	VEICOLI COMMERCIALI - LCV VEHICLE	1-59
0927409	-	MAN	6-27				
0927409	3463320106	MERCEDES	7-52	1211400	2D0422831	VEICOLI COMMERCIALI - LCV VEHICLE	1-38
0927410	-	MAN	6-28				
0927410	3465860133	MERCEDES	7-52	1211430	7H0422831	VEICOLI COMMERCIALI - LCV VEHICLE	1-101
0927411	6113300019	MERCEDES	7-52				
0927412	6013300019	MERCEDES	7-52	1211477	406683 *	VEICOLI COMMERCIALI - LCV VEHICLE	1-9
0927416	3103301219	MERCEDES	7-52				
0927419	6703300119	MERCEDES	7-53	1211481	-	VEICOLI COMMERCIALI - LCV VEHICLE	1-40
0927420	6703300219	MERCEDES	7-53				
0927432	3553300319	MERCEDES	7-53	1211482	-	VEICOLI COMMERCIALI - LCV VEHICLE	1-34
0927432	3553300319	MERCEDES BUS	16-21				
0927436	3895860033	MERCEDES	7-53	1211589	4408476 *	VEICOLI COMMERCIALI - LCV VEHICLE	1-61
0927436	3895860033	MERCEDES BUS	16-21				
0927437	3463300019	MERCEDES	7-53	1214105	701411041	VEICOLI COMMERCIALI - LCV VEHICLE	1-97
0927438	3463300119	MERCEDES	7-53				
0927440	6253300119	MERCEDES	7-54	1214109	7D0411045	VEICOLI COMMERCIALI - LCV VEHICLE	1-97
0927441	6253300219	MERCEDES	7-54				
0927443	5000794320	RENAULT V.I.	9-26	1214127	251411041C	VEICOLI COMMERCIALI - LCV VEHICLE	1-93
0927444	5000793849	RENAULT V.I.	9-26				
0927445	5000794319	RENAULT V.I.	9-27	1214270	701411041D	VEICOLI COMMERCIALI - LCV VEHICLE	1-97
0927446	5000793828	RENAULT V.I.	9-27				
0927447	5000794318	RENAULT V.I.	9-27	1214276	7D1411041	VEICOLI COMMERCIALI - LCV VEHICLE	1-97
0927450	-	RENAULT V.I.	9-28				
0927450	-	RENAULT V.I. BUS	18-8	1215173	-	VEICOLI COMMERCIALI - LCV VEHICLE	1-7
0927452	550713	SCANIA	10-21				
0927452	550713	SCANIA BUS	19-8	1215174	-	VEICOLI COMMERCIALI - LCV VEHICLE	1-7
0927453	550729	SCANIA	10-21				
0927453	550729	SCANIA BUS	19-8	1215175	-	VEICOLI COMMERCIALI - LCV VEHICLE	1-7
0927454	550257	SCANIA	10-21				
0927455	550284	SCANIA	10-21	1215176	-	VEICOLI COMMERCIALI - LCV VEHICLE	1-3
0927456	270911	VOLVO	11-27				
0927456	270911	VOLVO BUS	20-9	1215177	-	VEICOLI COMMERCIALI - LCV VEHICLE	1-3
0927458	270912	VOLVO	11-27				
0927458	270912	VOLVO BUS	20-9	1215269	93807641	VEICOLI COMMERCIALI - LCV VEHICLE	1-33
0927742	81.44205.6016	MAN	6-27				
0983868	4059922	VEICOLI COMMERCIALI - LCV VEHICLE	1-26	1215270	93807640	VEICOLI COMMERCIALI - LCV VEHICLE	1-33
0993868	4059921	VEICOLI COMMERCIALI - LCV VEHICLE	1-26				
1211063	9750000380	VEICOLI COMMERCIALI - LCV VEHICLE	1-11	1215271	93810239	VEICOLI COMMERCIALI - LCV VEHICLE	1-33
1211064	9750000280	VEICOLI COMMERCIALI - LCV VEHICLE	1-11				
				1215388	4339248	VEICOLI COMMERCIALI - LCV VEHICLE	1-13
				1215491	1300720080	VEICOLI COMMERCIALI - LCV VEHICLE	1-17
				1215503	-	VEICOLI COMMERCIALI - LCV VEHICLE	1-52
				1215504	-	VEICOLI COMMERCIALI - LCV VEHICLE	1-52
				1215609	4500094	VEICOLI COMMERCIALI - LCV VEHICLE	1-56
				1215610	4500095	VEICOLI COMMERCIALI - LCV VEHICLE	1-56
				1215640	8200002868	VEICOLI COMMERCIALI - LCV VEHICLE	1-62
				1215641	8200002869	VEICOLI COMMERCIALI - LCV VEHICLE	1-62

**Cross Reference Guide**

RIF. OCAP REF. OCAP	RIF. ORIG O.E. NUMBER	MARCA	PAG.	RIF. OCAP REF. OCAP	RIF. ORIG O.E. NUMBER	MARCA	PAG.
1215659	701407087	VEICOLI COMMERCIALI - LCV VEHICLE	1-94				
1215660	701407077A	VEICOLI COMMERCIALI - LCV VEHICLE	1-96				
1215661	701407183C	VEICOLI COMMERCIALI - LCV VEHICLE	1-96				
1215662	701501131	VEICOLI COMMERCIALI - LCV VEHICLE	1-97				
1215663	701407140B	VEICOLI COMMERCIALI - LCV VEHICLE	1-97				
1215671	-	VEICOLI COMMERCIALI - LCV VEHICLE	1-97				
1215677	-	VEICOLI COMMERCIALI - LCV VEHICLE	1-27				
1215678	4131788	VEICOLI COMMERCIALI - LCV VEHICLE	1-27				
1215704	6393330214	VEICOLI COMMERCIALI - LCV VEHICLE	1-54				
1215705	2D0407140	VEICOLI COMMERCIALI - LCV VEHICLE	1-39				
1215817	6013210350	VEICOLI COMMERCIALI - LCV VEHICLE	1-41				
1215822	-	VEICOLI COMMERCIALI - LCV VEHICLE	1-6				
1215823	-	VEICOLI COMMERCIALI - LCV VEHICLE	1-6				
1215872	7H0407182A	VEICOLI COMMERCIALI - LCV VEHICLE	1-102				
1215873	7H0407183	VEICOLI COMMERCIALI - LCV VEHICLE	1-102				
1215874	9063330014	VEICOLI COMMERCIALI - LCV VEHICLE	1-41				
1215877	6608818	VEICOLI COMMERCIALI - LCV VEHICLE	1-25				
1215878	6517356	VEICOLI COMMERCIALI - LCV VEHICLE	1-25				
1215953	504039506	VEICOLI COMMERCIALI - LCV VEHICLE	1-32				
1216016	4419217 Z	VEICOLI COMMERCIALI - LCV VEHICLE	1-60				
1216017	4419218 Z	VEICOLI COMMERCIALI - LCV VEHICLE	1-60				
1216245	BK213A262AC	VEICOLI COMMERCIALI - LCV VEHICLE	1-29				
1216246	BK213059A	VEICOLI COMMERCIALI - LCV VEHICLE	1-29				
1216307	5006305917	IVECO BUS	14-12				
1216308	500345518	IVECO BUS	14-12				