

AUXILIARY HEATER (HI-OUTPUT) AH24535/24 VOLT

CONTENTS:

Heater • Mounting Brackets • Instruction Sheet • Installation Kit

Kit Includes:

- | | |
|-----------------------|--------------------|
| (2) Mounting Brackets | (4) Screws |
| (2) Y Splicers | (1) 15 AMP Fuse |
| (2) Rubber Grommets | (1) 3 Speed Switch |
| (8) Hose Clamps | (1) Control Knob |



INSTALLATION DIAGRAM:

Materials required to install this heater are available in the kit shown above. In addition you will need 5/8" heater hose and 14 GA wire.



FRONT VIEW



REAR VIEW

INSTALLATION INSTRUCTIONS:

1. This versatile heater may be mounted either horizontally or vertically. Typical locations include floor, wall or under dash. Mark the inlet and outlet tube locations and cut a hole through the vehicle's floor. Grommets are included, but may not be required for below floor mounting. Mount the heater to the floor using the provided mounting brackets.
2. Route the heater hose to the engine compartment. We recommend the heater hose follow the inside of the frame rails for protection from road debris. Wire ties or clamps may be used to secure the hose to the frame. Please note that all hoses must clear all driveline or moving parts and must be securely fastened to the frame to avoid potential damage to the hose and cooling system. In the engine compartment, locate where the existing heater hoses pass through the fire wall. On the engine side of the fire wall, cut and insert the Y splicers in the existing heater hoses, as close to the firewall as possible. Secure all the Y splicer connections with hose clamps, then install the new heater hose to the auxiliary heater. Avoid any sharp bends which may kink the hose and restrict proper flow. (See splicer diagram.)
3. Mount the switch panel in a convenient under dash location. Route power supply wire from fuse block to rocker switch, including inline 15 AMP fuse. Clip plug, then connect the red, orange and yellow wires from the heater to the switch extending them where necessary. Finally, ground the black wire to the chassis of the vehicle. We recommend all electrical connections are terminated or soldered and taped. (See the connection diagram below.)

WIRE CONNECTION DIAGRAM:

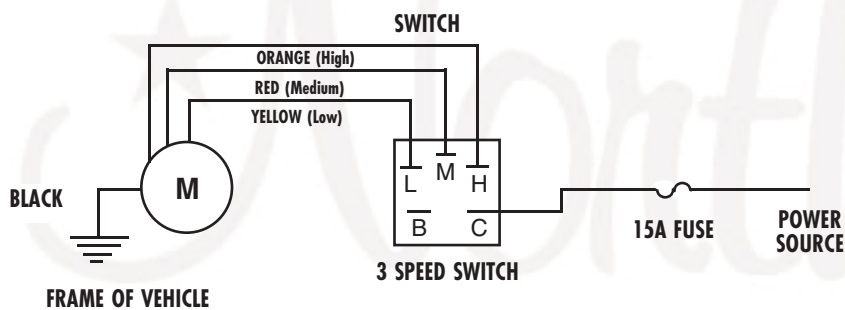

SPLICER DIAGRAM:

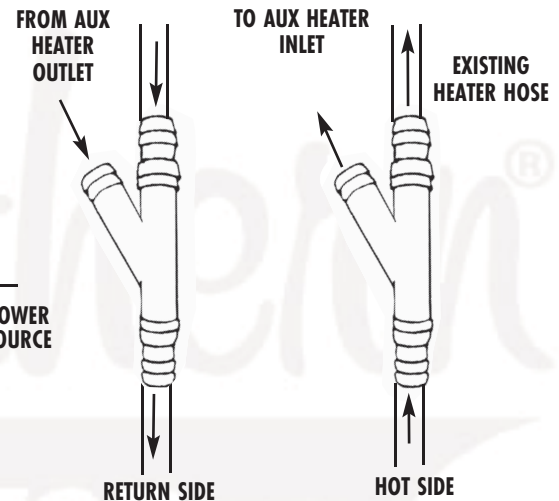

NOTE: The low speed terminal is located behind the high position due to internal switching.