



I-SHHET #: INST-00224
PART NUMBER: TST16CC-TX
PRODUCT: **TRAIL SLIDER**
APPLICATION: **16-20 Tacoma CREW Cab SWB**

HARDWARE DESCRIPTION	QTY.
HWKT-03054X	1
M8 X 30MM FLANGE CAPSCREW W/WASHER	12

PARTS INCLUDED	QTY
Driver side slider	1
Passenger side slider	1



TRAIL SLIDER

Step 1 Identify the Driver and Passenger side step.

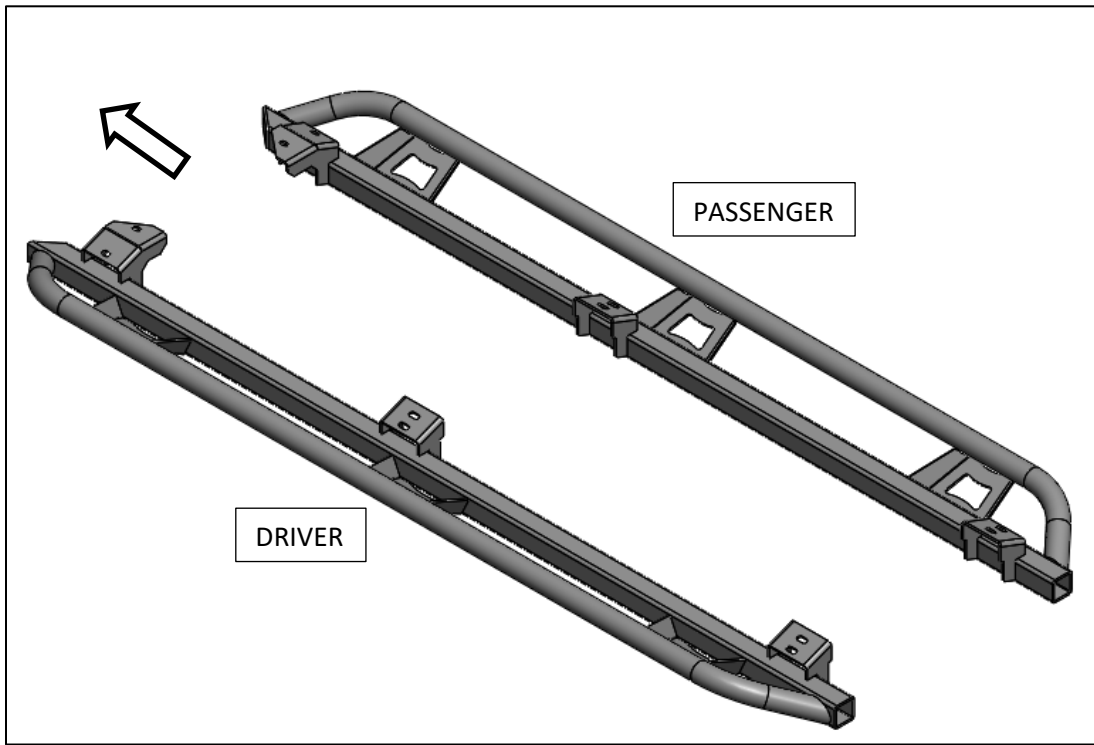

Step 2 Remove any factory hardware and discard. (Fig. A)

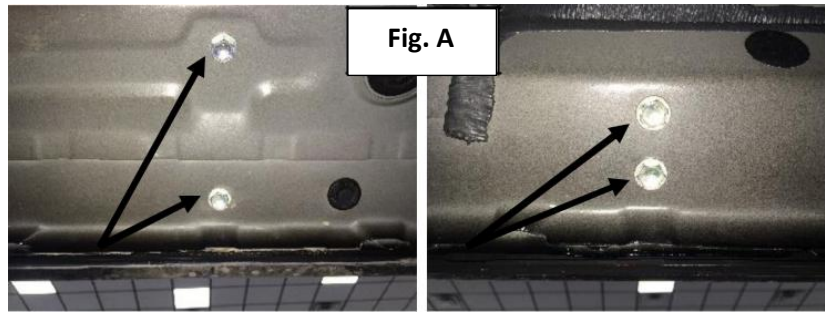

Step 3 Starting with the driver side, position Trail slider up to the body of the vehicle and align the brackets up with the factory mounting locations.



Step 4 Beginning with the center bracket, start one of the M8x30mm hex bolts into the factory bolt location and leave loose. Start the second M8x30mm hex bolt in the same bracket and loosely tighten.



Step 5 Start all remaining M8x30mm hex bolts in each bracket and leave loose.

Step 6 After final positioning torque each bolt location to 17 ft/lbs – 21 ft/lbs.

Step 7 Repeat steps 2-6 for passenger side step.

Step 8 This concludes the install.