



2019 PRODUCT CATALOG



BOX BLINDS | GROUND BLINDS | LADDERSTANDS | HANG-ON STANDS | CLIMBER STANDS | CLIMBING SYSTEMS
SAFETY HARNESSSES | TRAIL CAMERAS | POD STANDS | SEATS | ACCESSORIES



- 01 NEW PRODUCTS
- 04 BOX BLINDS
- 18 LADDERSTANDS
- 31 HANG-ON STANDS
- 36 CLIMBER STANDS
- 38 CLIMBING SYSTEMS
- 42 HARNESSES
- 52 TRAIL CAMERAS
- 58 TRAIL CAMERA ACCESSORIES
- 60 POD STANDS
- 64 GROUND BLINDS
- 68 SEATS
- 72 ACCESSORIES
- 82 COMPARISON CHARTS



NEW FOR 2019

HUNT HARD CAMERA ARM

MODEL MCA150 | PAGE 73



DEFENDER SECURITY CABLE

MODEL MA3531 | PAGE 80



SAFEGUARD PINK

MODEL MSH40S-S/M | PAGE 46



660 LB. DIGITAL SCALE

MODEL GSD660 | PAGE 80



BOSS

MODEL MFP1080 | PAGE 32

COMPLETE STAND KIT

MODEL MA9045 | PAGE 78



HUNTSMAN DELUXE
MODEL MIS1300 | PAGE 23



SKYBOX DELUXE
MODEL MIS1550 | PAGE 21



ODYSSEY XTL
MODEL MIS1776 | PAGE 24



FEATURING

HERCULES

CROSS GRIP SAFETY SYSTEM

STRONGHOLD 2.5 XTL
MODEL MIS2251 | PAGE 26



NEXUS XTL
MODEL MIS2601 | PAGE 30



BOX BLINDS

“We’ve been using box blinds for years, but never have we seen success like we’ve seen since using the Muddy line of box blinds. These blinds are over built, and do a superb job of containing your scent which gives us the advantage we’ve been looking for. If you can beat a deer’s nose, you’re doing something right. Great job, Muddy!”

- Mark Drury
Drury Outdoors





CONSTRUCTION

THERE IS NO COMPARISON, MUDDY IS SUPERIOR TO OTHER FIBERGLASS OR MOLDED PLASTIC SETUPS.

THERMA-TEK: Innovative structural insulated design provides **ULTIMATE THERMAL CONTROL, SCENT CONTROL, AND NOISE CONTROL!**

- Exterior Grade UV Protected PVC, 1.5 Pound Density Foam, Tempered Hardboard, Marine Carpet are bonded together for unbeatable performance!
- **THERMAL CONTROL** – Panels have an R-7 insulation value; Offers superior climate control
- **SCENT CONTROL** – Each seam is sealed with aircraft grade sealant/adhesive to keep the elements out and scent in
- **NOISE CONTROL** – The innovative Therma-Tek design offers the ultimate noise barrier. Entire wall panel is carpeted



SOLID FLOOR: Joist and sheeting construction

- Super strong and quiet!
- **Dead air chamber** provides insulation
- Noise control



HEAVY-DUTY ROOF: Rotational molded polymer construction

- Ultimate in strength to handle **any snow load**
- **Hollow-core technology** provides dead air gap on the roof for insulation and added strength
- A full **6"** of **roof overhang** to defend against even the toughest elements





INTERIOR



DURABLE CARPET: Dark color keeps you hidden, sound deadening, floor removable for easy cleaning

- SHELF:**
- 1 Rotational molded shelf
 - Raised lip around the entire perimeter to help keep items on shelf
 - Molded-in drink holder & cubby box
 - Two 1/4" – 20 molded-in inserts into shelf to allow the use of many accessories using 1/4" – 20 threads
 - Holes provided to integrate a towel bar (bar not included)

TALL ENOUGH TO STAND



Made in USA

SHIPPED FULLY ASSEMBLED!



WINDOWS



- Residential quality glass
- Gasket lined
- All metal hardware

**QUIET, EFFECTIVE,
AND SECURE!**

SILENT, ONE-HANDED OPERATION

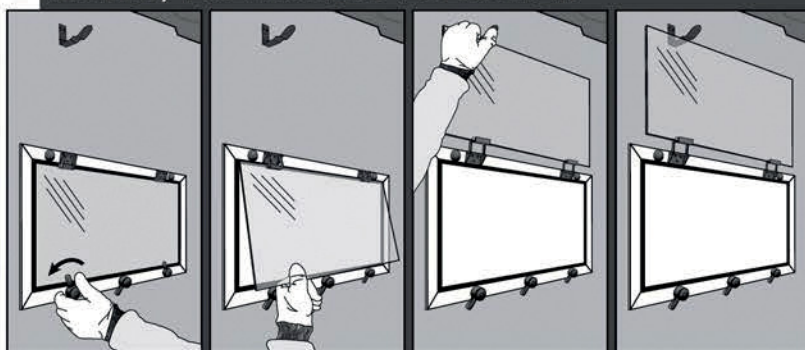

TWIST LATCH OPEN

RAISE WINDOW

LIFT SPRING LOCK

SECURE

- CONSTRUCTION:** Residential quality glass, gasket lined, with all metal hardware
- PERFECT STANDING OR SITTING HEIGHT FOR FULL 360° VIEWING & SHOOTING**
- ULTRA-QUIET WINDOW LATCHES**

DOOR

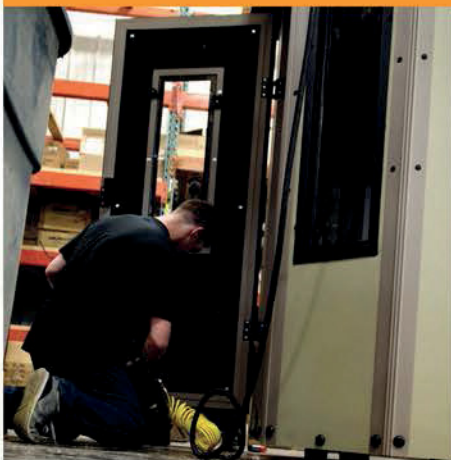

- FULL-SIZE DOOR TO ALLOW FOR EASY ENTRY EVEN WHEN WEARING A PACK**
- FULL GASKET + CO-EXTRUDED DOOR TRIM FOR THE ULTIMATE IN PERFORMANCE AND DURABILITY**
- LOCKABLE KEYED ENTRY DOOR**



BULL BLIND COMBO

CONSTRUCTION	<ul style="list-style-type: none"> ● FLOOR: JOIST AND SHEETING ● WALLS: THERMA-TEK PANELS ● ROOF: HEAVY-DUTY ROTATIONAL MOLDED PLASTIC ● WINDOWS: RESIDENTIAL QUALITY GLASS AND ALL STEEL HARDWARE ● TOWER: HEAVY-DUTY POWDER-COATED STEEL
BLIND	6' SQUARE x 6.5' TALL

DOOR	30"W x 70"T
WINDOWS	<ul style="list-style-type: none"> ● WALL: 33" WIDE x 13" TALL ● CORNER: 12" WIDE x 42" TALL ● DOOR: 13" WIDE x 33" TALL, LOCKS
LADDER	15" WIDE, HANDRAIL FOR SUPPORT, NON-SLIP STEPS

MODEL BBB4000-10C (BULL AND ELITE 10' TOWER)
 MODEL BBB4005 (BULL AND ELITE 5' TOWER)



Enough space to be functional for traditional bow, crossbow, or rifle hunting



Non-slip Steps & Platform





BULL BLIND

CONSTRUCTION

- FLOOR: JOIST AND SHEETING
- WALLS: THERMA-TEK PANELS
- ROOF: HEAVY-DUTY ROTATIONAL MOLDED PLASTIC
- WINDOWS: RESIDENTIAL QUALITY GLASS AND ALL STEEL HARDWARE

BLIND

6' SQUARE
x 6.5' TALL

DOOR

30"W x 70"T

WINDOWS

- WALL: 33" WIDE x 13" TALL
- CORNER: 12" WIDE x 42" TALL
- DOOR: 13" WIDE x 33" TALL

WEIGHT

500 LBS.

Built for use as a ground blind or to be mounted on Elite 5' Tower Model BBT500 (sold separately)

MODEL BBB4000



Leg stakes & ground anchor system included



Made in USA

SHIPPED FULLY ASSEMBLED!

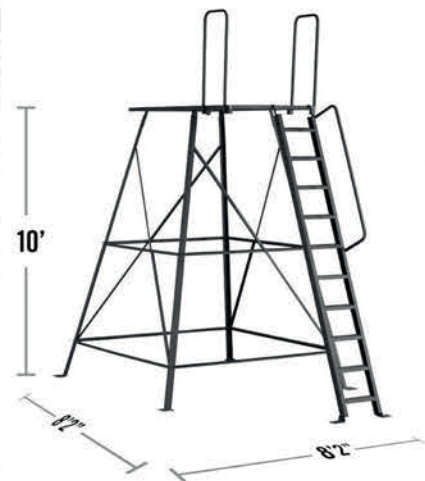

ELITE 5FT TOWER

MODEL BBT500

- **CONSTRUCTION:** Heavy-duty powder-coated steel
- **LADDER:** 15" wide, handrail for support, non-slip steps
- **LANDING:** 43" wide x 20" deep, non-slip, spacious for easy entry into blind
- **STAKES:** Includes (4) 24" leg stakes, (1) 30" ground anchor with cable & turnbuckle
- **WEIGHT:** 250 lbs.

ELITE 5FT TOWER EXTENSION KIT

MODEL BBT510

- **CONSTRUCTION:** Heavy-duty powder-coated Steel
- **USE:** Raises Model BBT500 Elite 5' tower height to 10'

ELITE 10FT TOWER

MODEL BBT500 & BBT510

- **ASSEMBLY:** Combines Model BBT500 Elite 5' Tower and Model BBT510 Elite 5' Tower Extension Kit to complete the Elite 10' Tower.



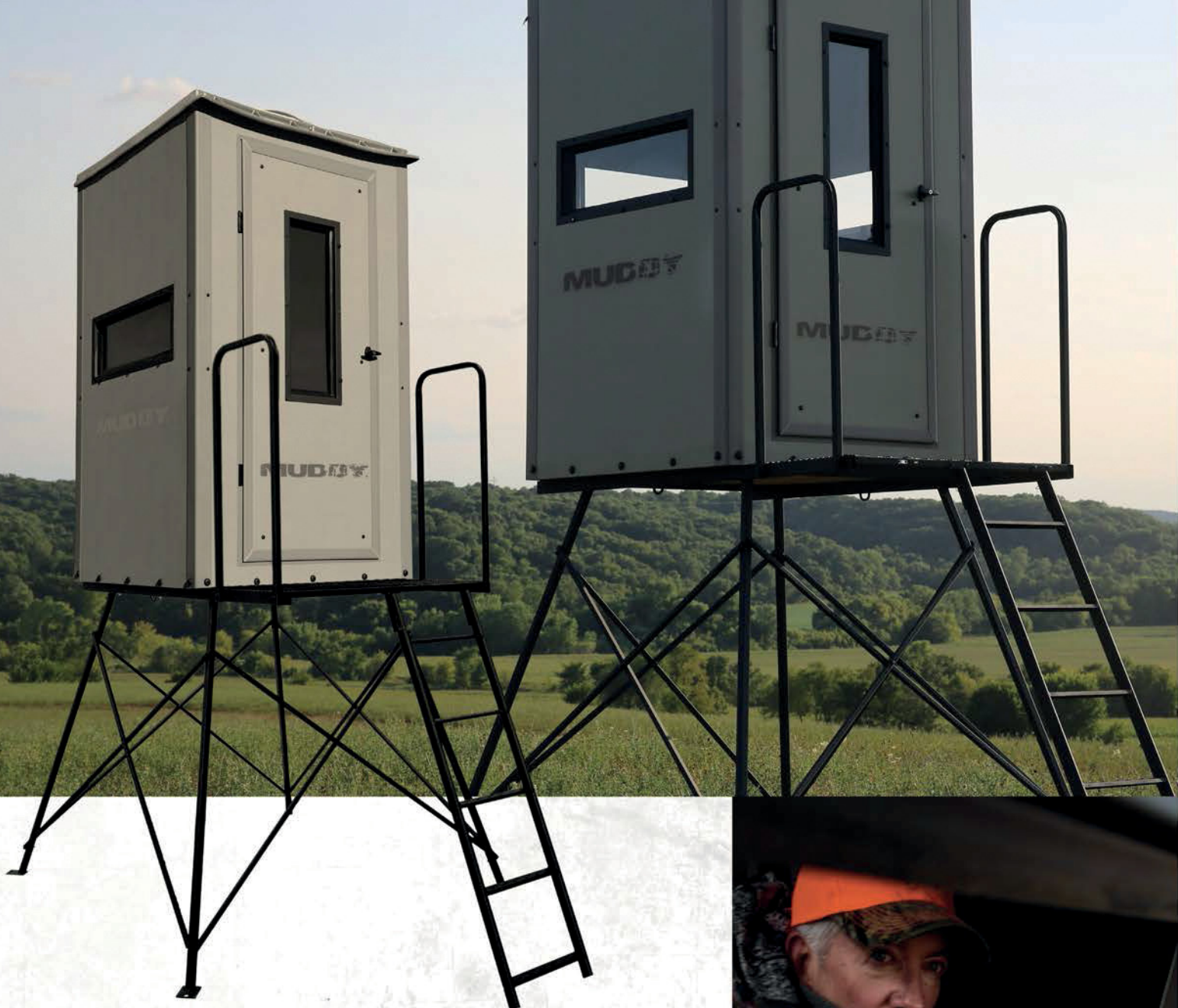

GUNNER COMBO

CONSTRUCTION	<ul style="list-style-type: none"> ● FLOOR: JOIST AND SHEETING ● WALLS: THERMA-TEK PANELS ● ROOF: HEAVY-DUTY MOLDED PLASTIC ● WINDOWS: RESIDENTIAL QUALITY GLASS AND ALL STEEL HARDWARE ● TOWER: HEAVY-DUTY POWDER-COATED STEEL
BLIND	4' SQUARE x 7' TALL
DOOR	30"W x 70"T
WINDOWS	(4) 33" WIDE x 13" TALL
LADDER	NON-SLIP, SPACIOUS FOR EASY ENTRY INTO BLIND

MODEL BBB1000-5C (GUNNER AND DELUXE 5' TOWER)
 MODEL BBB1010 (GUNNER AND DELUXE 10' TOWER)

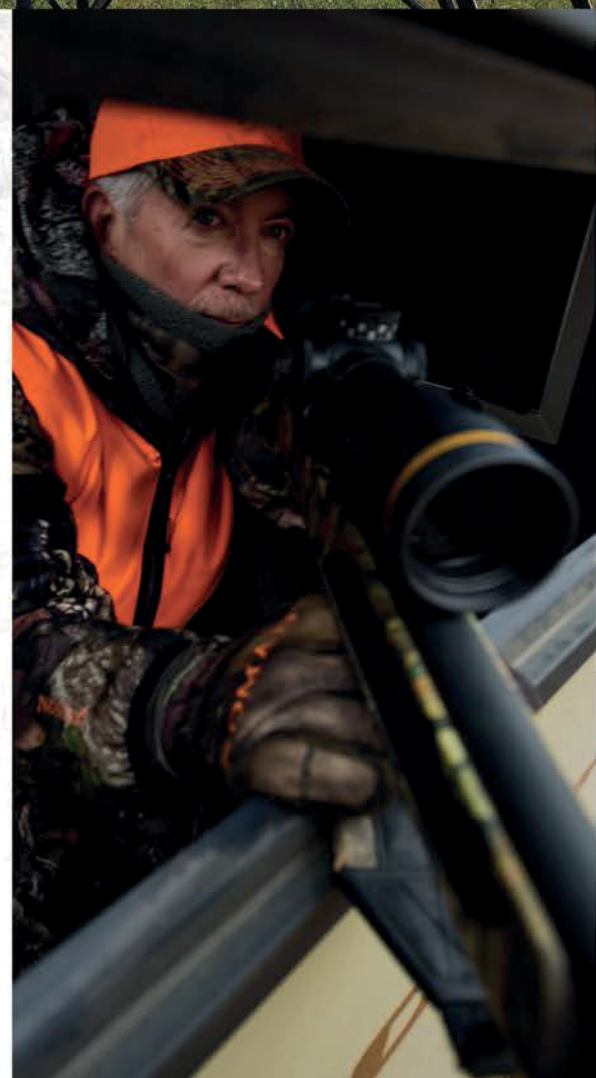

GUNNER

CONSTRUCTION

- **FLOOR:** JOIST AND SHEETING
- **WALLS:** THERMA-TEK PANELS
- **ROOF:** HEAVY-DUTY MOLDED PLASTIC
- **WINDOWS:** RESIDENTIAL QUALITY GLASS AND ALL STEEL HARDWARE

BLIND 4' SQUARE x 7' TALL

DOOR 30"W x 70"T

WINDOWS (4) 33" WIDE x 13" TALL

WEIGHT 270 LBS.



MODEL BBB1000



SHIPPED FULLY ASSEMBLED!

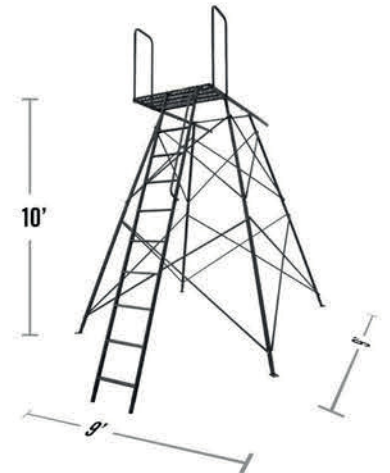
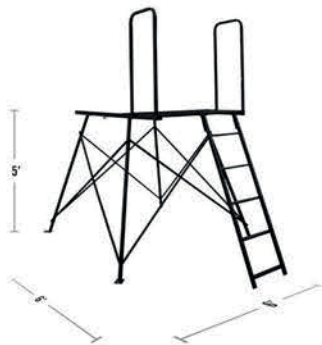

DELUXE 5FT TOWER

MODEL BBT200

- **CONSTRUCTION:** Heavy-duty powder-coated steel
- **LADDER:** 15" wide, handrail for support, non-slip steps
- **LANDING:** 43" wide x 20" deep, non-slip, spacious for easy entry into blind
- **STAKES:** Includes 4: 24" leg stakes, 1: 30" ground anchor with cable & turnbuckle
- **WEIGHT:** 250 lbs.

DELUXE 5FT TOWER EXTENSION KIT

MODEL BBT210

- **CONSTRUCTION:** Steel
- **USE:** Raises Elite 5' tower BBT500 height to 10'

DELUXE 10FT TOWER

MODEL BBT200 & BBT210

- **ASSEMBLY:** Combines Model BBT200 Deluxe 5' Tower and Model BBT210 Deluxe 5' Tower Extension Kit to complete the Deluxe 10' Tower.



PENTHOUSE COMBO

- CONSTRUCTION**
- FLOOR: JOIST AND SHEETING
 - WALLS: THERMA-TEK PANELS
 - ROOF: HEAVY-DUTY ROTATIONAL MOLDED PLASTIC
 - WINDOWS: RESIDENTIAL QUALITY GLASS AND ALL STEEL HARDWARE
 - TOWER: HEAVY-DUTY POWDER-COATED STEEL

BLIND	87"W x 69"D x 78"T
DOOR	30" WIDE x 70" TALL
WINDOWS	<ul style="list-style-type: none"> ● HORIZONTAL: 33"W x 19"T ● VERTICAL: 12"W x 42"T
LADDER	15"WIDE, HANDRAIL FOR SUPPORT, NON-SLIP STEPS

MODEL BBB7010 (PENTHOUSE AND ELITE 10' TOWER)
 MODEL BBB7005 (PENTHOUSE AND ELITE 5' TOWER)



PENTHOUSE

CONSTRUCTION

- **FLOOR:** JOIST AND SHEETING
- **WALLS:** THERMA-TEK PANELS
- **ROOF:** HEAVY-DUTY ROTATIONAL MOLDED PLASTIC
- **WINDOWS:** RESIDENTIAL QUALITY GLASS AND ALL STEEL HARDWARE
- **TOWER:** HEAVY-DUTY POWDER-COATED STEEL

BLIND 87"W x 69"D x 78"T

DOOR 30" WIDE x 70" TALL

WINDOWS

- **HORIZONTAL:** 33"W x 19"T
- **VERTICAL:** 12"W x 42"T

WEIGHT 530 LBS.



MODEL BBB7000



SHIPPED FULLY ASSEMBLED!

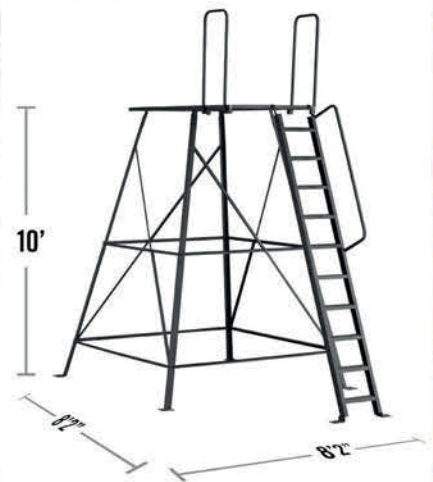

ELITE 5FT TOWER

MODEL BBT500

- **CONSTRUCTION:** Heavy-duty powder-coated steel
- **LADDER:** 15" wide, handrail for support, non-slip steps
- **LANDING:** 43" wide x 20" deep, non-slip, spacious for easy entry into blind
- **STAKES:** Includes (4) 24" leg stakes, (1) 30" ground anchor with cable & turnbuckle
- **WEIGHT:** 250 lbs.

ELITE 5FT TOWER EXTENSION KIT

MODEL BBT510

- **CONSTRUCTION:** Heavy-duty powder-coated Steel
- **USE:** Raises Model BBT500 Elite 5' tower height to 10'

ELITE 10FT TOWER

MODEL BBT500 & BBT510

- **ASSEMBLY:** Combines Model BBT500 Elite 5' Tower and Model BBT510 Elite 5' Tower Extension Kit to complete the Elite 10' Tower.





SOFT SIDE 360 COMBO

CONSTRUCTION	DURABLE THERMA-TEK FABRIC FOR SUPERIOR INSULATION
DIMENSIONS	72" x 72" X 85" TALL
WINDOWS	SILENT ZIPPER WINDOW SYSTEM WITH SLIDEING MESH BACKING
TOWER	ATTACHES TO THE DELUXE OR ELITE TOWERS

MODEL BBB0755 (SOFT SIDE 360 & DELUXE 5' TOWER)
 MODEL BBB0760 (SOFT SIDE 360 & DELUXE 10' TOWER)



Quiet foam padded floor



Non-slip surface for safe and easy entry



SOFT SIDE 360

CONSTRUCTION DURABLE THERMA-TEK FABRIC FOR SUPERIOR INSULATION

DIMENSIONS 72" x 72" X 85" TALL

WINDOWS SILENT ZIPPER WINDOW SYSTEM WITH SLIDING MESH BACKING

MODEL BBB0750



SWIVEL-EASE XTREME

CONSTRUCTION	STEEL FRAME
MATERIAL	FLEX-TEK SEAT
WEIGHT	16 LBS.
WEIGHT RATING	300 LBS.
FEATURES	FOOTREST, SWIVELS 360°

MODEL MGS600



SEAT HEIGHT ADJUSTS 17" TO 24"

UNIVERSAL WINDOW CURTAIN KIT

CONSTRUCTION	BLACKED OUT QUIET FABRIC; BLACK BACKED
USE	BLACK OUT WINDOWS TO KEEP YOU CONCEALED
SIZE	CUSTOM FIT FOR THE GUNNER, BULL, AND PENTHOUSE BOX BLINDS

MODEL BBA002



"The window kits are a must for hunting from a box blind! Great way to stay concealed while still being able to see what game is coming your way." -Joseph



Velcro strips hold curtain kit to window; peep hole included

BOX BLIND BOW HANGER

CONSTRUCTION	STEEL WITH RUBBER COATING TO PROTECT GEAR
USE	HANG BOW OR GEAR FROM MUDDY BOX BLIND
SIZE	7" TALL X 4" WIDE
WEIGHT RATING	20 LBS.

MODEL BBA-BH1



Keeps gear within reach



UNIVERSAL WINDOW GUN REST

CONSTRUCTION	TEXTURED, REINFORCED, WATER RESISTANT MATERIAL
USE	MOUNTS OVER BOX BLIND WINDOW, SHOOTING RAIL OR FENCE
SIZE	REST SITS 2" HIGH 8.5" TALL X 5" WIDE

MODEL BBA-GR1



Leather rest for gun stock

UNIVERSAL 6' x 6' PLATFORM KIT

CONSTRUCTION	STEEL
USE	ATTACHES TO ELITE OR DELUXE TOWERS. ADD A GROUND BLIND, BALE BLIND, OR SOFT SIDED BLIND TO PLATFORM

MODEL BBT050 (UNIVERSAL 6' X 6' PLATFORM KIT)
 MODEL BBT255 (UNIVERSAL 6' X 6' PLATFORM KIT & DELUXE 5' TOWER BBT200)
 MODEL BBT260 (UNIVERSAL 6' X 6' PLATFORM KIT & DELUXE 5' TOWER BBT200 WITH 5' EXTENSION KIT BBT210)

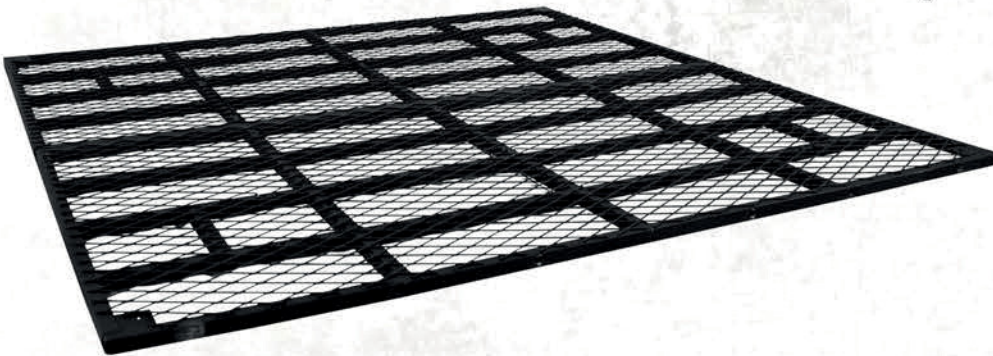

LADDERSTANDS

“As my kids are getting older, they have started to show more interest in hunting with me. This past year we setup some Muddy 2-man ladderstands on our farm and they were the ticket to helping introduce my kids to the outdoors. Solid heavy duty construction and noise free, these stands gave me the confidence to enjoy the outdoors with my children sitting right beside me.”

-Joe Sir
Rizen Media



FEATURE PACKED!

EVERY ITEM HAS PURPOSE DRIVEN
FEATURES TO IMPROVE THE EXPERIENCE!

SILENT: BECAUSE WE ALL KNOW THAT BEING STEALTHY
IS IMPORTANT!

TREESTAND FEATURES:



- **ZERO METAL ON METAL CONTACT!** NYLON WASHERS & CAPS PREVENT ANY NOISE ON PIVOTING OR CONTACT POINTS!
- **BOLTED LADDER-SECTIONS!** PREVENTS NOISY MOVEMENT DURING CLIMBING & DESCENT.
- **SILENT MATERIAL ON SEATS & RAILS!** NO NOISE WHILE SHIFTING OR SETTING UP!
- **MANY ITEMS HAVE SILENT CAM ATTACHMENT SYSTEMS.**

COMFORTABLE: BECAUSE IF YOU AREN'T COMFORTABLE,
YOU'RE MOVING AND IF YOU'RE MOVING
YOU'LL BE SEEN!

TREESTAND FEATURES:



- **COMFORTABLE SEATS!** EITHER FLEX-TEK, ZERO-GRAVITY SEATS OR OUR LUXURIOUS TRI-PLEX TRIPLE LAYER FOAM SEAT SYSTEMS PROVIDE ALL DAY COMFORT IN ANY STAND!
- **WATERPROOF SEATS!** STAY DRY, HUNT LONGER.

STRONG: HEAVY DUTY MATERIAL & UNIQUE FABRICATION
= DEPENDABILITY!

TREESTAND FEATURES:



- **STRONG TUBING;** ITEMS FEATURE EITHER 1" SQUARE TUBING OR IN SOME CASES WIDER RECTANGULAR OR OVAL TUBING. EVERY STAND IS OVERBUILT WITH SECURITY, SAFETY, AND COMFORT IN MIND.
- **PLATFORMS FEATURE EITHER D-FORCE EXPANDED OR LYNX FABRICATED EXPANDED METAL.** NO FLEX AND GOOD GRIPPING FOR A SOLID STANCE!
- **EVERY PRODUCT HAS OUR ADVANCE FIBER-GUARD POWDER COATING FOR DURABILITY AND THE TEXTURED FINISH OFFERS MORE GRIP.**
- **CLIMBERS FEATURE OUR FAST ATTACH CABLE SYSTEM FOR QUICK AND EASY ADJUSTMENTS**



BOSS HAWG 1.5

HEIGHT	17' TALL
FOOT PLATFORM	28"W x 30"D
SEAT	24"W x 17"D x 27"T FLIPS BACK
STAND WEIGHT	67 LBS.
WEIGHT RATING	350 LBS.

MODEL MLS1900

17'
HEIGHT



Comfortable & spacious seat; flips back for full platform use



Weight rating **350lbs**



Flip-back, padded shooting rail



Lumbar support seat

Quiet, Padded shooting rest and armrests

Silencer technology throughout the stand; no metal on metal contact

All steel is powder coated with Fiber-Guard

Flip-back footrest



NEW SKYBOX DELUXE

HEIGHT	20' TALL
FOOT PLATFORM	19"W x 25"D
SEAT	22"W x 17"D x 19" FLIPS BACK
STAND WEIGHT	73 LBS.
WEIGHT RATING	300 LBS.

MODEL MLS1550



 FLEX-TEK™	 D-FORCE
 FOOTREST	 SILENCERS
 FIBER-GUARD	 BOLTED LADDER SECTIONS

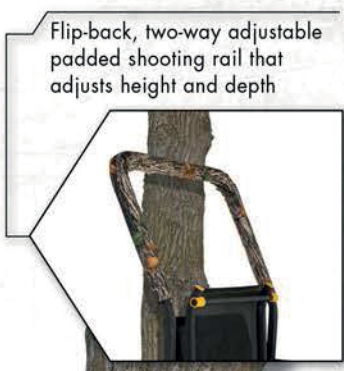

Ultra comfort lumbar style seat

Quiet, Padded shooting rest

Silencer technology throughout the stand; no metal on metal contact

D-Force expanded metal grates

Double rail ladder



HUNTSMAN

HEIGHT	17' TALL
FOOT PLATFORM	19"W x 25"D
SEAT	20"W x 15"D x 19"T FLIPS BACK
STAND WEIGHT	55 LBS.
WEIGHT RATING	300 LBS.

MODEL MLS1200



FLEX-TEK™	D-FORCE
FOOTREST	SILENCERS
FIBER-GUARD	BOLTED LADDER SECTIONS

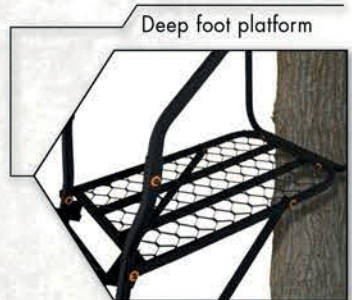

Removable, flip-back, TWO-WAY adjustable padded shooting rail that adjusts height and depth

Silencer technology throughout the stand; no metal on metal contact

All steel is powder coated with Fiber-Guard



NEW HUNTSMAN DELUXE

HEIGHT	17' TALL
FOOT PLATFORM	19"W x 25"D
SEAT	22"W x 17"D x 19"T FLIPS BACK
STAND WEIGHT	55 LBS.
WEIGHT RATING	300 LBS.

MODEL MLS1300

**17'
HEIGHT**

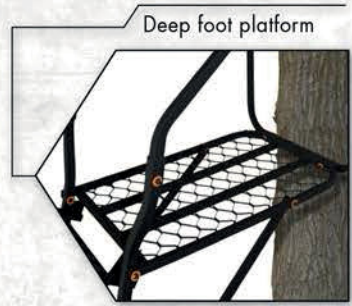
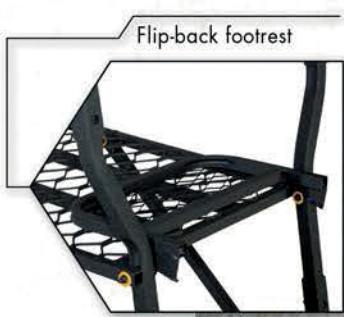

Lumbar support seat

Removable, flip-back, TWO-WAY adjustable padded shooting rail that adjusts height and depth

Silencer technology throughout the stand; no metal on metal contact

All steel is powder coated with Fiber-Guard



NEW

ODYSSEY XTL

HEIGHT	20' TALL
FOOT PLATFORM	18"W x 26"D
SEAT	22"W x 17"D x 19"T FLIPS BACK
STAND WEIGHT	75 LBS.
WEIGHT RATING	300 LBS.

MODEL MLS1776

20'
HEIGHT

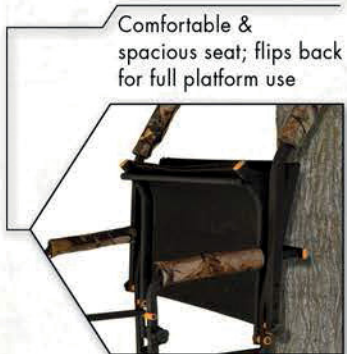

Comfortable & spacious seat; flips back for full platform use



1 x Drink Holder + 1 x Accessory Hook

FEATURING
HERCULES
CROSS GRIP SAFETY SYSTEM

Quiet, Padded shooting rail and armrests

DXT oval tubing; strong, sturdy & easy to grip

Silencer technology throughout the stand; no metal on metal contact

All steel is powder coated with Fiber-Guard

Flip-back footrest



STRONGHOLD 1.5

HEIGHT	21' TALL
FOOT PLATFORM	27"W x 14"D
SEAT	26"W x 18"D x 24"T
STAND WEIGHT	71 LBS.
WEIGHT RATING	300 LBS.

MODEL MLS1150

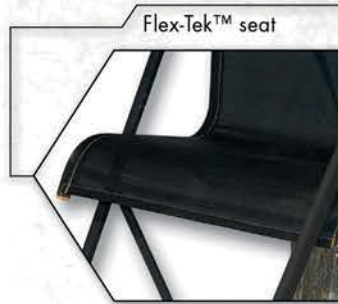
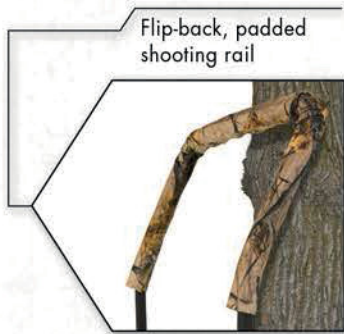

Quiet, Padded shooting rest

Extra large lumbar style seat for all day comfort

D-Force expanded metal grates

Silencer technology throughout the stand; no metal on metal contact

DXT oval tubing; strong, sturdy & easy to grip



NEW **STRONGHOLD** 2.5 XTL

HEIGHT	18' TALL
FOOT PLATFORM	50"W x 17"D
SEAT	24"W x 17"D x 27"T PER SEAT
STAND WEIGHT	105 LBS.
WEIGHT RATING	500 LBS.

MODEL MLS2251

18'
HEIGHT



FLEX-TEK™	FOOTREST
D-FORCE	FIBER-GUARD
SILENCERS	BOLTED LADDER SECTIONS
DX TUBING	RS TUBING

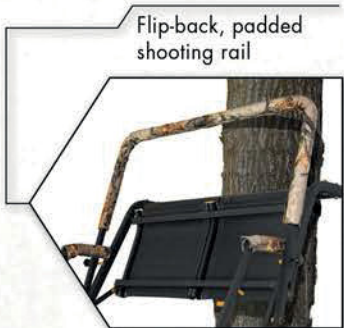

FEATURING
HERCULES
CROSS GRIP SAFETY SYSTEM

Comfortable Flex-tek seat with backrest

Padded shooting rail

Padded armrests

Interchangeable cup holders & accessory hooks

Wide foot platform with footrest

Oval tubing; strong, sturdy & easy to grip



REBEL 2.5

HEIGHT	17' TALL
FOOT PLATFORM	45"W x 30"D
SEAT	21"W x 17"D x 27"T, FLIPS BACK
STAND WEIGHT	101 LBS.
WEIGHT RATING	500 LBS.

MODEL MLS2800



17'
HEIGHT

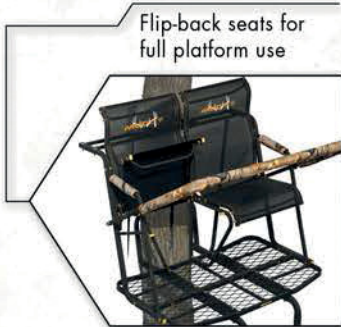

Flip-back seats for full platform use



Adjustable and flip-back shooting rail



Comfortable Flex-tek seat with backrest

Padded armrests

Padded shooting rail

Amazingly wide & spacious foot platform

DXT oval tubing; strong, sturdy & easy to grip



BIG BUDDY

HEIGHT	16' TALL
FOOT PLATFORM	38"W x 12"D
SEAT	38"W x 17"D x 18"T
STAND WEIGHT	64 LBS.
WEIGHT RATING	500 LBS.

MODEL MLS2200



16'
HEIGHT



FLEX-TEK™



D-FORCE



SILENCERS



BOLTED LADDER SECTIONS



FIBER-GUARD



MADE TO FIT BLIND KIT II

MODEL MCB-MF2

- **FOR USE WITH:** The Big Buddy Ladderstand - MODEL MLS2200 (This blind may fit future stands as well, see stand box for more details.)
- **ENTRANCE OPENING:** 25" x 25" Zippered closure
- **FASTENERS:** Snaps & bungee cords



Comfortable and spacious seat



Flip-back, padded shooting rail



Padded, flip-back shooting rail

Extremely comfortable Flex-Tek seat

Fiber-Guard powder coated steel

D-Force grates for added strength and traction



PARTNER

HEIGHT	17' TALL
FOOT PLATFORM	40"W x 33"D
SEAT	37"W x 18"D x 18"T FLIPS BACK
STAND WEIGHT	88 LBS.
WEIGHT RATING	500 LBS.

MODEL MLS2300

17'
HEIGHT



**MADE TO FIT
BLIND KIT III**

MODEL MCB-MF3

- FOR USE WITH:**
 The Nexus Ladderstand - MODEL MLS2600
 & The Partner Ladderstand - MODEL
 MLS2300 (This blind may fit future stands as
 well, see stand box for more details.)
- ENTRANCE OPENING:** 25" x 25" Zippered
 closure
- FASTENERS:** Snaps & bungee cords

Padded, flip-back
shooting rail & flip-
back seat



Extra-wide foot platform
with foot rest



Flex-tek seats for all
day comfort

Fiber-Guard powder
coated steel

D-Force grates for
added strength and
traction

Flip-back foot rest



"Just purchased this stand, very comfortable seat for 2 people. Well-designed stand with the shooting rail that lifts out of the way for bow hunting. Or use the rail for a gun rest." - Tim



NEW

NEXUS XTL

HEIGHT	20' TALL
FOOT PLATFORM	42"W x 34"D
SEAT	39"W x 17"D x 19"T FLIPS BACK
STAND WEIGHT	115 LBS.
WEIGHT RATING	500 LBS.

MODEL MLS2601

20'
HEIGHT



Flip-back seat;
adjustable padded shooting
rail that flips-back



2 x Drink Holder + 2x
Accessory Hook



FEATURING

HERCULES

CROSS GRIP SAFETY SYSTEM

Comfortable Flex-tek
seat with backrest

Padded armrests

Padded shooting rail

Interchangeable cup
holders & accessory
hooks

Rectangle tubing;
extremely rigid for
stability

Wide foot platform with
footrest

Oval tubing; strong,
sturdy & easy to grip



HANG-ON STANDS

“Muddy hang-on stands are made with the serious hunter in mind. Reliable, well built, and solid, Muddy continues to set the standard for quality products for the serious hunter who demands the most out of the gear they trust.”

-Joe Sir
Rizen Media



STEEL

BOSS™ NEW

CONSTRUCTION	STEEL
FOOT PLATFORM	24"W x 30"D
STAND WEIGHT	16 LBS.
WEIGHT RATING	300 LBS.

MODEL MFP1080

- FLEX-TEK™
- D-FORCE
- FIBER-GUARD
- SILENT STRAP SYSTEM
- SILENCERS
- PACKABLE
- WATERPROOF



STEEL

BOSS™ XL

CONSTRUCTION	STEEL
FOOT PLATFORM	25"W x 34"D
FOOTREST	FIXED
STAND WEIGHT	20 LBS.
WEIGHT RATING	300 LBS.

MODEL MFP1200

- FLEX-TEK™
- D-FORCE
- FIBER-GUARD
- SILENT STRAP SYSTEM
- SILENCERS
- PACKABLE
- FOOTREST
- WATERPROOF



Flex-tek seat

Seat flips back for full platform use

Silent straps, no metal on metal contact

Wide stance platform with fixed footrest

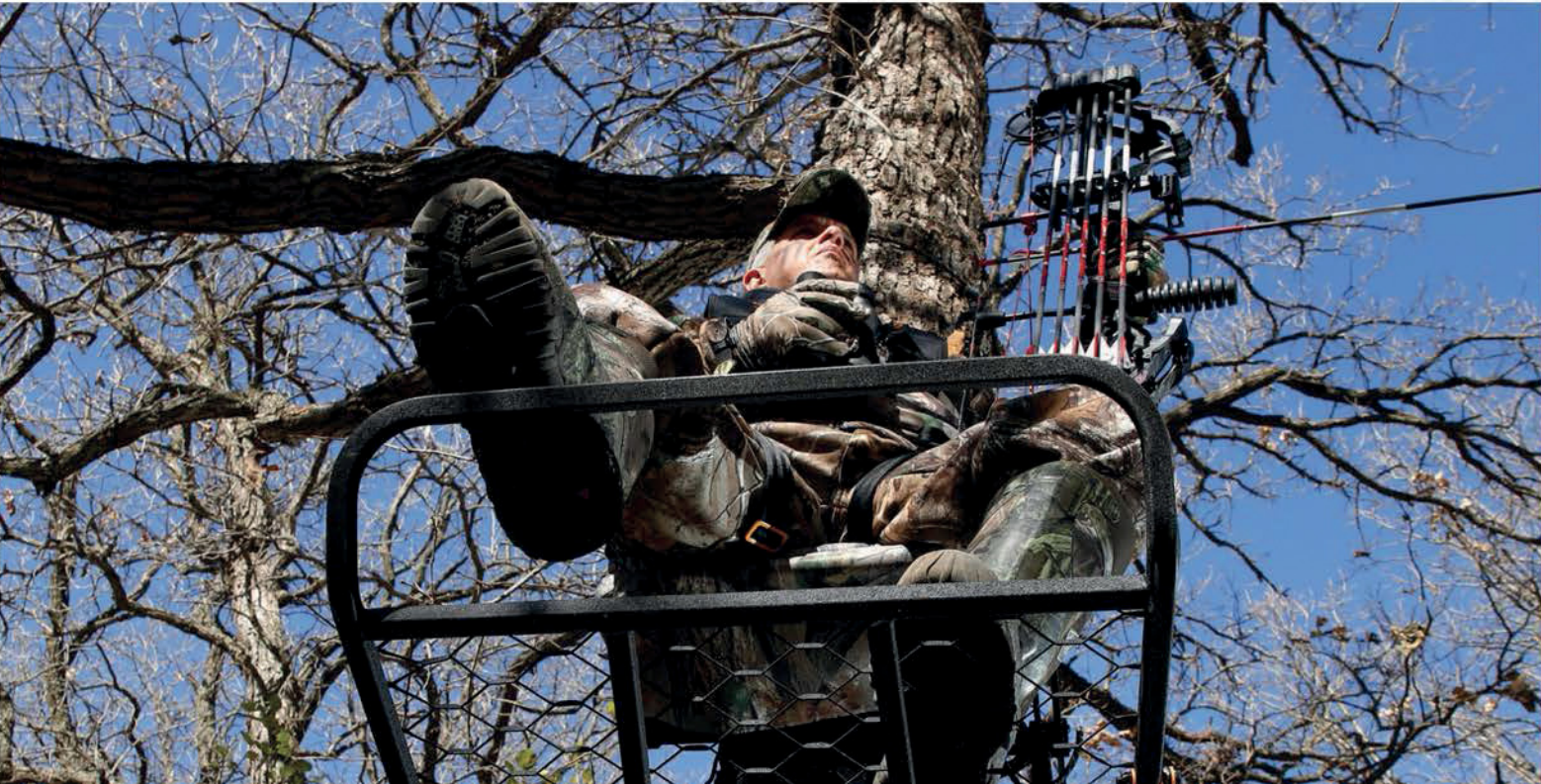

STEEL

OUTFITTER

CONSTRUCTION	STEEL
FOOT PLATFORM	24"W x 34"D
FOOTREST	FLIPS BACK
STAND WEIGHT	22 LBS.
WEIGHT RATING	300 LBS.

MODEL MFP3205



TRI-PLEX FOAM



D-FORCE



FIBER-GUARD



SILENT STRAP SYSTEM



SILENCERS



PACKABLE



FOOTREST



WATERPROOF



PEG PACK



ALUMINUM

BOSS ELITE AL

CONSTRUCTION	ALUMINUM
FOOT PLATFORM	20"W x 37"D
FOOTREST	FLIPS BACK
STAND WEIGHT	20 LBS.
WEIGHT RATING	300 LBS.

MODEL MFP5100-A

-  FLEX-TEK™
-  LYNX EXPANDED METAL
-  FIBER-GUARD
-  SILENT STRAP SYSTEM
-  SILENCERS
-  PACKABLE
-  FOOTREST
-  WATERPROOF

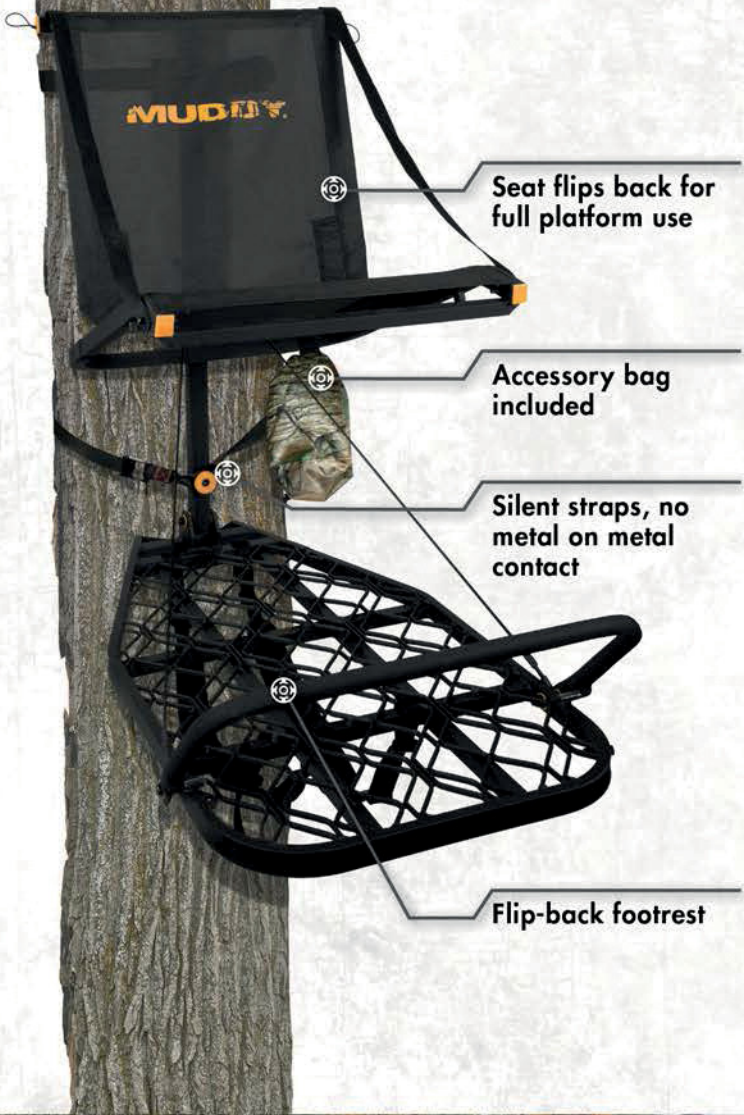

Seat flips back for full platform use

Accessory bag included

Silent straps, no metal on metal contact

Flip-back footrest

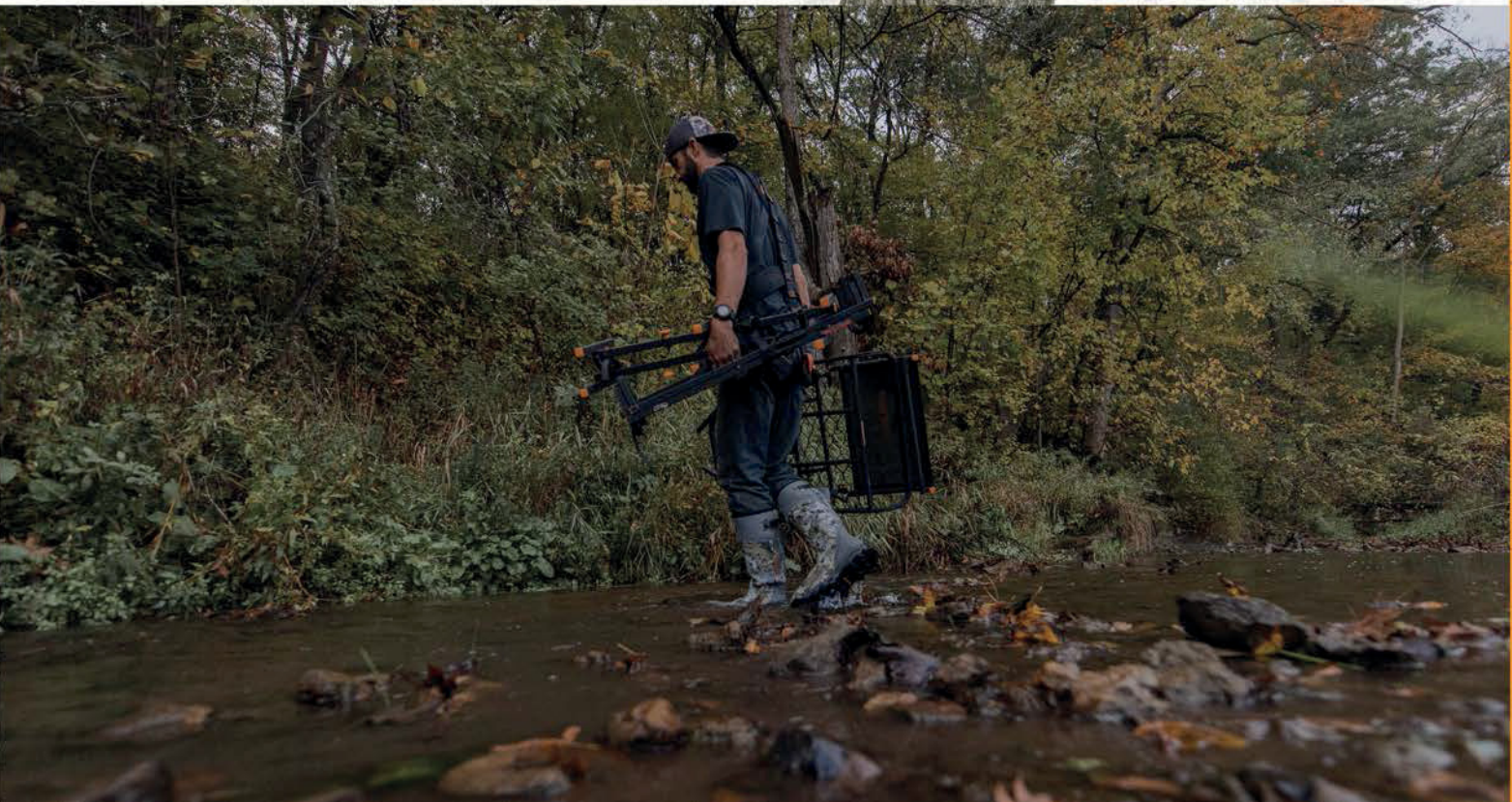



Fast attach silent cable system for quick and easy adjustments

Padded armrests & seat bar

Nylon netted seat

Non-slip slats on foot platform

Backpack straps included



4 Platform adjustment options



Accessory bag included



Backpack straps included for easy transport



ALUMINUM

STALKER

CONSTRUCTION	ALUMINUM
FOOT PLATFORM	20"W x 28"D
STAND WEIGHT	19 LBS.
WEIGHT RATING	300 LBS.

MODEL MCL150-A





Padded backrest

Padded armrest & seat bar

Padded, sling-style seat for comfort

Fast attach cable system for quick and easy adjustments

Rubber-coated foot straps

Flip-back footrest

Non-slip slats on foot platform

*Patent Pending



"Recently purchased a Woodsman Climber and I'm extremely satisfied with this product. Went together easily, climbs great, light and extremely sturdy. This my first climbing stand, the only regret that I have is that I didn't buy this stand years ago." - John



Fast attach cable system



Backpack straps included



Accessory bag included

ALUMINUM

WOODSMAN

CONSTRUCTION	ALUMINUM
FOOT PLATFORM	20.5"W x 29.5"D
FOOTREST	FLIPS BACK
STAND WEIGHT	25 LBS.
WEIGHT RATING	300 LBS.

MODEL MCL300-A



CLIMBING SYSTEMS

“Muddy not only makes top of the line treestands, but also top of the line climbing systems. From portable and lightweight, to more stationary models, Muddy has you covered every step of the climb.”

- Matt Drury
Drury Outdoors



20'
HEIGHT

Ladder-like climb for extreme stability

9" wide, square steps

Silent cam-buckle fastening system

Steel bark biters attach to the tree

Durable powder coat finish

MUDDY

20'
HEIGHT

Durable powder coat finish

Silencers; plastic caps and nylon washers throughout

10.5" wide steps

Steel construction

QUICK STEP XL

HEIGHT	20' TALL
WEIGHT	27 LBS. (TOTAL WEIGHT)
WEIGHT RATING	300 LBS.

MODEL MCS1020

QUICK-STICK XL

HEIGHT	20' TALL
STEP WIDTH	10.5"
SECTIONS	5 PIECES
STAND WEIGHT	25 LBS. (TOTAL WEIGHT)
WEIGHT RATING	300 LBS.

MODEL MCS0120





20'
HEIGHT

Silencers; plastic caps and nylon washers throughout

11" wide solid oval tubing steps

Steel construction



Enclosed step for added stability

Each section is 31" long

Steel Construction

Works great on not so straight trees

Rock solid performance

ASCENDER

HEIGHT	20' TALL
STEP WIDTH	11"
SECTIONS	5 PIECES
STAND WEIGHT	33 LBS. (TOTAL WEIGHT)
WEIGHT RATING	300 LBS.

MODEL MCS0520

STAGGER-STEPS

STEP WIDTH	9"
AVAILABLE MODELS	1 SECTION MODEL MCS1200 3 SECTIONS MODEL MCS1200-3
WEIGHT	4 LBS. EACH
WEIGHT RATING	300 LBS.

MODEL MCS1200, MCS1200-3



8" between the step & tree for a safer climb



Packable for easy carrying & storage



ALUMINUM



Geared dual-fold steps make a safer more durable step

Rope cam system for QUICK & QUIET install

The ultimate climbing stick for the mobile hunter

Each step has built-in teeth for extra grip

ALUMINUM

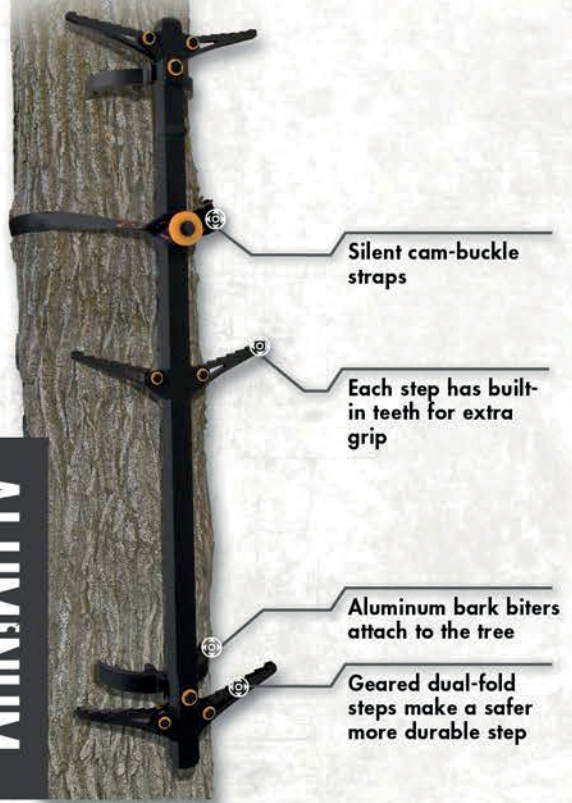

Silent cam-buckle straps

Each step has built-in teeth for extra grip

Aluminum bark biters attach to the tree

Geared dual-fold steps make a safer more durable step

PRO CLIMBING STICKS

CONSTRUCTION	ALUMINUM
STEP WIDTH	9.25"
SECTIONS	4 PIECES; 20" EACH
WEIGHT	2.5 LBS. EACH
WEIGHT RATING	300 LBS.

MODEL MCS2000-4

AEROLITE CLIMBING STICKS

CONSTRUCTION	ALUMINUM
STEP WIDTH	10"
SECTIONS	3 PIECES; 32" EACH
WEIGHT	3 LBS. EACH
WEIGHT RATING	350 LBS.

MODEL MCS3000-3A



"The Muddy Pro Climbing Sticks are hands down the best sticks I have ever used. They are light weight, they pack nicely and they are a breeze to install..." - Jeff



Peg-pack series; sticks pack together with several compatible Muddy fixed-position treestand models



HARNESSES

“Muddy safety harnesses are simply the best in the business. Muddy has multiple harness options for every hunter, and ensure that I’ll return home safely after each hunt.”

-Taylor Drury
Drury Outdoors



AMBUSH

CAMO	OPTIFADE ELEVATED II
CONSTRUCTION	LIGHT WEIGHT PADDED NYLON
BUCKLES	STANDARD QUICK RELEASE BUCKLES
WEIGHT	1.9 LBS.
WEIGHT RATING	300 LBS.

MODEL MSH500



One-hand, quick-set carabiner clip



Flexible tether for 360° movement



Optifade Elevated II Camo Pattern

New innovative binocular cables are lightweight yet extremely durable

Padded waist strap for extreme comfort

Suspension relief strap pocket for easy access



Quick-release leg buckles with adjustable leg straps



New durable elastic chest strap to keep harness tight to chest

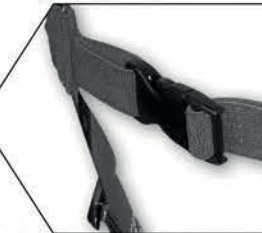

CROSSOVER COMBO

CONSTRUCTION	LIGHT WEIGHT PADDED NYLON
BUCKLES	STANDARD QUICK-RELEASE
WEIGHT	2 LBS.
WEIGHT RATING	300 LBS.

MODEL MSH600-SM-C = SMALL/MEDIUM
 MODEL MSH600-L-C = LARGE
 MODEL MSH600-XL-C = EXTRA LARGE

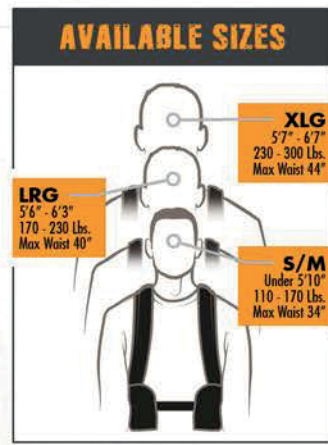

One-hand, quick-set carabiner clip

Flexible tether for 360° movement

6 pockets + built-in binocular straps

Quick-release leg buckles with adjustable leg straps

INCLUDED!

THE SAFE-LINE

STAY CONNECTED AT ALL TIMES
 USE WITH ANY LADDERSTAND
 OR FIXED POSITION

SEE PAGE 23 FOR MORE DETAILS.



- Includes:**
- Lineman's Rope
 - Tree Strap
 - Suspension Relief Strap
 - Carabiner
 - Safe-Line



Padded shoulders & back for comfort & endurance for long sits

DIAMONDBACK

CONSTRUCTION	LIGHT WEIGHT PADDED NYLON
BUCKLES	STANDARD QUICK-RELEASE
WEIGHT	2 LBS.
WEIGHT RATING	300 LBS.

SIZE: ONE SIZE FITS MOST
MODEL MSH300



Air-flow mesh for breathability

Easy cinch adjustable chest strap



Easy to use, no tangle design = once personal adjustments have been made goes on in seconds

Silencers; no metal on metal contact



- Includes:
- Lineman's Rope
 - Tree Strap
 - Suspension Relief Strap
 - Carabiner



Quick-release leg buckles with adjustable leg straps



Flexible tether allows 360° movement



One-hand carabiner loop



"I just purchased a new Diamondback harness and while I haven't hunted with it yet I have worn it while hanging stands and it was awesome! The padded straps combined with the lightweight make it very comfortable to wear and the buckles make it very easy to get on and off. The tether is a nice length as well as I had plenty of room to move while setting my stands while still being secure." - Chad



NEW SAFEGUARD™

CONSTRUCTION	LIGHT WEIGHT PADDED NYLON
BUCKLES	CAM LEG BUCKLES
WEIGHT	1.9 LBS.
WEIGHT RATING	300 LBS.

MODEL MSH405-S/M = ONE SIZE FITS MOST



(2) gear lanyards;
instant access to gear

Easy cinch adjustable
chest straps and waist
belt

Silent, vinyl coated
parachute waist buckle

Extra leg cushion



"Fits my 12 year old daughter pretty well. Being adjustable, she will be able to use it for a long time. Very happy with this purchase" - Kenneth



Specifically fit to
feminine figure



Extremely gear
friendly, keeps
everything within
reach

SAFEGUARD™

CONSTRUCTION	LIGHT WEIGHT PADDED NYLON
BUCKLES	CAM LEG BUCKLES
WEIGHT	1.9 LBS.
WEIGHT RATING	300 LBS. (YOUTH = 150 LBS.)

MODEL MSH400-Y = YOUTH
 MODEL MSH400-SM = SMALL/MEDIUM
 MODEL MSH400-L = LARGE
 MODEL MSH400-XL = EXTRA LARGE



**Less fabric =
Less scent, super
lightweight**

**Extra cushion;
padded
shoulders**

**Binocular straps
for quick &
convenience**

Padded waist

**Noiseless &
adjustable leg
buckles; no metal
on metal contact**

AVAILABLE SIZES

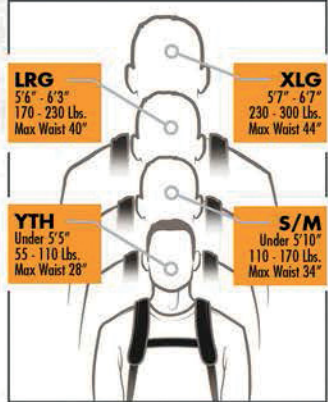

- Includes:**
- Lineman's Rope
 - Tree Strap
 - Suspension Relief Strap
 - Carabiner

**Flexible
tether
for 360°
movement**



MAGNUM PRO

CONSTRUCTION	LIGHT WEIGHT PADDED NYLON
BUCKLES	CAM LEG BUCKLES
WEIGHT	1.5 LBS.
WEIGHT RATING	300 LBS.

SIZE: ONE SIZE FITS MOST
MODEL MSH110



Rugged tether reduces chances of fall/injury

Easy cinch adjustable torso straps

 Padded waist

 Noiseless & adjustable leg buckles; no metal on metal contact

- Includes:
- Lineman's Belt
 - Tree Strap
 - Suspension Relief Strap



 Extra cushion; padded shoulders = comfort & endurance for long sits



MAGNUM ELITE

CONSTRUCTION	LIGHT WEIGHT PADDED NYLON
BUCKLES	STANDARD QUICK-RELEASE
WEIGHT	2 LBS.
WEIGHT RATING	300 LBS.

MODEL MSH120



Rugged tether
reduces chances of
fall/injury

 Air-flow
mesh for
breathability

Extreme silent
material to keep you
undetected

Easy cinch
adjustable chest
strap

Padded waist



Extra cushion;
padded shoulders
= comfort &
endurance for
long sits



Easy cinch
adjustable chest



Quick-release
leg buckles with
adjustable leg
straps



SAFE-LINE



Two prusik knots; Slides easily up and down; Stops you immediately should a fall occur.



STAY CONNECTED AT ALL TIMES

USE WITH ANY LADDERSTAND OR HANG-ON!

USE	SAFE FROM THE MOMENT YOU LEAVE THE GROUND TO THE TIME YOU RETURN!	
2 MODELS	1 PACK MODEL MSA500	3 PACK MODEL MSA500-3
LENGTH	30'	
WEIGHT RATING	300 LBS.	

MODEL MSA500, MSA500-3

30' braided nylon

REFLECTIVE material that enhances daytime and low-light visibility

SAFETY HARNESSTREE STRAP

CONSTRUCTION	STEEL BUCKLE; STITCHED NYLON
LOOP	EXTRA THICK, DOUBLE STITCHED
SIZE	1.5 LBS.
WEIGHT RATING	300 LBS.

MODEL MSA050



Large loop for easy secure carabiner clipping

SAFETY HARNESSLINEMAN'S ROPE

USE	SAFE TREE CLIMBING WHILE INSTALLING TREESTAND, SAFE-LINE, OR ANY OTHER ELEVATED HUNTING EQUIPMENT
CONSTRUCTION	BRAIDED NYLON
WEIGHT RATING	300 LBS.

MODEL MSA070



Easy to use, quick-clip design



Includes prusik knot + one-handed lockable carabiner combo

SAFETY HARNESS CARABINER



CONSTRUCTION	STEEL
TYPE	ONE-HAND LOCKING
SIZE	ONE SIZE FITS MOST
WEIGHT RATING	300 LBS.

MODEL MSA060

SAFETY HARNESS ALUMINUM CARABINER



CONSTRUCTION	ALUMINUM
TYPE	ONE-HAND LOCKING
SIZE	ONE SIZE FITS MOST
WEIGHT RATING	300 LBS.

MODEL MSA080

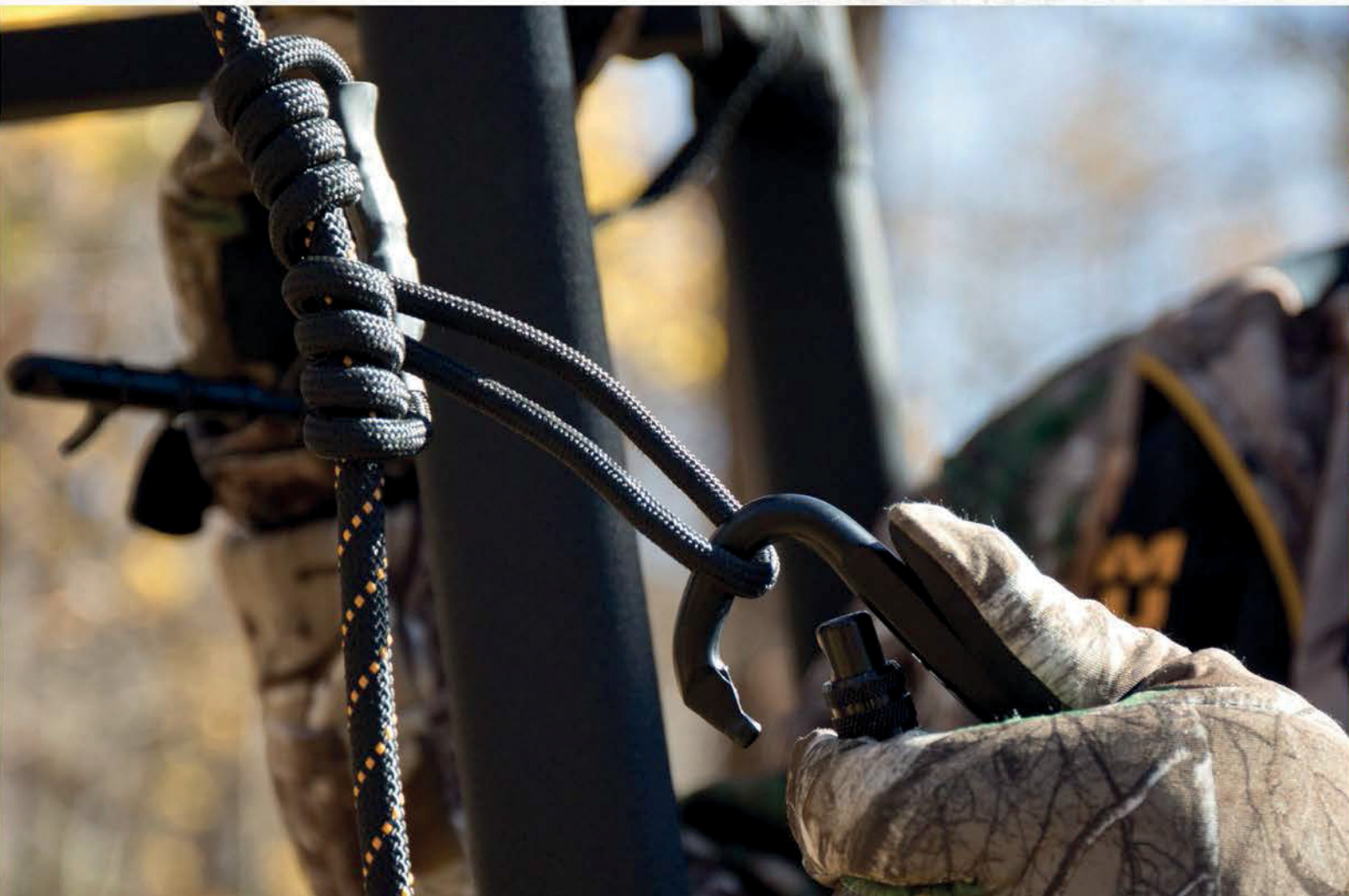

TRAIL CAMERAS

“No matter the time of year, we rely heavily on our Muddy Pro Cams to pattern and inventory the bucks on the properties we hunt. Packed full of features and dependable, Muddy trail cameras truly do help us when it comes to filling tags on mature whitetails!”

-Pat Reeve
CO-HOST, DRIVEN TV



PHOTO BURST OPTIONS



SIMPLE TO PROGRAM



INVISIBLE FLASH



*(SOLD SEPARATELY—EXCEPT FOR MODELS MTC600K AND MTC200-K; 8GB SD CARD & 6AA BATTERIES ARE INCLUDED)

CRYSTAL CLEAR IMAGES

FULL COLOR DAYTIME IMAGES AND MONOCHROME NIGHTTIME IMAGES



CLIMATE SHIELD



PRO-CAM 20



"This is the best camera on the market. I love the how it blends into the surroundings. It captures great pictures and is easy to set up." - Cassie

FLASH	INVISIBLE FLASH
RESOLUTION	20 MP
DETECTION RANGE	70 FEET
TRIGGER SPEED	0.6 SECONDS
FLASH RANGE	70+ FEET
VIDEO	HD + SOUND VIDEO

MODEL MTC600 OR MTC600-K



SATISFACTION
100%
GUARANTEED

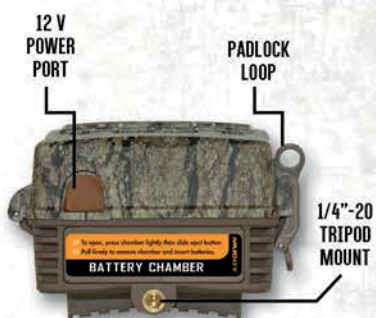

Non-reflective bark pattern camo on molded ABS housing

36 HE LEDs with invisible flash technology

3 Zone + 50° detection angle

Easy access latch + cable lock and padlock ready

Waterproof membrane protects camera from weather

SPECS

Camera Specifications	
Image Resolution	20 MP (Day), 5 MP (Night)
Image Detail	Color (Day), B/W (Night)
Video Mode	1280 x 720 HD with Sound or VGA (32 FPS) with Sound
Video Length	6 Options: 5 Sec - 2 Minutes (Day), 10 sec (Night)
Illumination	Invisible Flash with 36 HE LEDs
Detection Range	70 Feet
Trigger Speed	0.6 Seconds
Flash Range	70+ Feet
Burst Interval	2 Seconds or 0.6 Seconds
Field of View	3 Zone + 50° Detection Angle
Image Data	Camera ID, Date, Time, Temp, & Moon Phase
Camera Options - Beyond Optimal Presets	
Photo Burst	2 - 8 Photos
Trigger Delay	10 Options: 2.5 Sec. - 60 Min.
Time-lapse	Yes
Time-lapse Frequency	10 Options: 5 Sec. - 60 Min
Time-lapse Period	Customizable Start/End Time
SD Overwrite	Camera will overwrite oldest images on SD card if SD card is full

Physical Specs	
Dimensions	4.75" H x 4.25" W x 2.5" D
Material	Molded ABS
Finish	Non-reflective Bark Pattern
Housing	Waterproof
Settings Screen	Backlit LCD Screen
Mounting Options	Adjustable Strap with Buckle
Alt. Mounting	1/4" - 20
Theft Deterrence	Cable Lock and Padlock Ready
Technical Data	
Battery Life	Up to 10,000 Images
Batteries Required	6 AA
Alt. Power Option	12V DC
Memory Card	Secure Digital Up to 32 GB
Product Warranty	1 Year
Operating Temp.	-10° F to 140° F

BACKLIT LCD SCREEN

Backlit LCD Screen will allow the user to easily navigate through the settings any time of day.



Shooting a number of photos of the same area, spread out over a period of time. Custom settings from 1 hr-24hrs, with multiple intervals. This feature is great for images 200 plus yards away that you normally couldn't get.



Programmable 2-8 photo bursts and only .6 seconds delay between photos.

READY TO SET CAMERA BUNDLE

MODEL MTC600-K



8 GB
MEMORY CARD



6 AA BATTERIES
INCLUDED!



PRO-CAM



FLASH	INVISIBLE FLASH
RESOLUTION	14 MP
DETECTION RANGE	50 FEET
TRIGGER SPEED	1.5 SECONDS
FLASH RANGE	50+ FEET
VIDEO	STANDARD VGA (32 FPS)

MODEL MTC200 OR MTC200-K



SIMPLE TO PROGRAM



INVISIBLE FLASH

SATISFACTION
100%
GUARANTEED

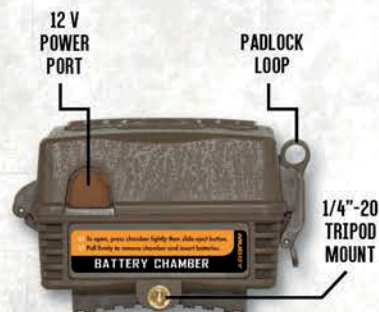

Non-reflective molded ABS housing

18 HE LEDs with invisible flash technology

3 Zone + 50° detection angle

Easy access latch + cable lock and padlock ready

Waterproof membrane protects camera from weather

SPECS

Camera Specifications	
Image Resolution	14 MP (Day), 5 MP (Night)
Image Detail	Color (Day), B/W (Night)
Video Mode	Standard VGA (32 FPS)
Video Length	4 Options: 10 - 60 seconds (Day), 10 sec (Night)
Illumination	Invisible Flash with 18 HE LEDs
Detection Range	50 Feet
Trigger Speed	1.5 Seconds
Flash Range	50+ Feet
Burst Interval	2 Seconds
Field of View	3 Zone + 50° Detection Angle
Image Data	Camera ID, Date, Time, Temp, & Moon Phase
Camera Options - Beyond Optimal Presets	
Photo Burst	2 - 6 Photos
Trigger Delay	7 Options: 10 Sec - 30 Min

Physical Specs	
Dimensions	4.75" H x 4.25" W x 2.5" D
Material	Molded ABS
Finish	Non-reflective Brown
Housing	Waterproof
Settings Screen	LCD Screen
Mounting Options	Adjustable Strap with Buckle
Alt. Mounting	1/4" - 20
Theft Deterrence	Cable Lock and Padlock Ready
Technical Data	
Battery Life	Up to 10,000 Images
Batteries Required	6 AA
Alt. Power Option	12V DC
Memory Card	Secure Digital Up to 32 GB
Product Warranty	1 Year
Operating Temp.	-10° F to 140° F

BACKLIT LCD SCREEN

Backlit LCD Screen will allow the user to easily navigate through the settings any time of day.



READY TO SET CAMERA BUNDLE

MODEL MTC200-K



8 GB
MEMORY CARD



6 AA BATTERIES
INCLUDED!



TRAIL CAMERA ACCESSORIES

ADJUSTABLE TRAIL CAMERA SUPPORT

MODEL MTCA-TCS02

CONSTRUCTION	STEEL
USAGE	SCREWS SECURELY INTO TREE; WORKS ON MOST CAMERAS WITH 1/4"-20 RECEIVER
FULLY ADJUSTABLE	CAMERA MOUNT CAN BE ADJUSTED TO ANY DIRECTION & ANGLE
WEIGHT RATING	10 LBS.



DUAL CAMERA GROUND MOUNT

MODEL MTCA-TCS03

CONSTRUCTION	STEEL
USAGE	STAKES SECURELY IN GROUND. WORKS ON MOST CAMERAS WITH 1/4" - 20 RECEIVER.
FULLY ADJUSTABLE	1 OR 2 CAMERAS SECURELY ATTACH. CAN ADJUST HEIGHT 19" TO 41". CAN ADJUST TO ANY DIRECTION & ANGLE.
WEIGHT RATING	25 LBS.

HEIGHT ADJUSTS FROM 19" TO 41"

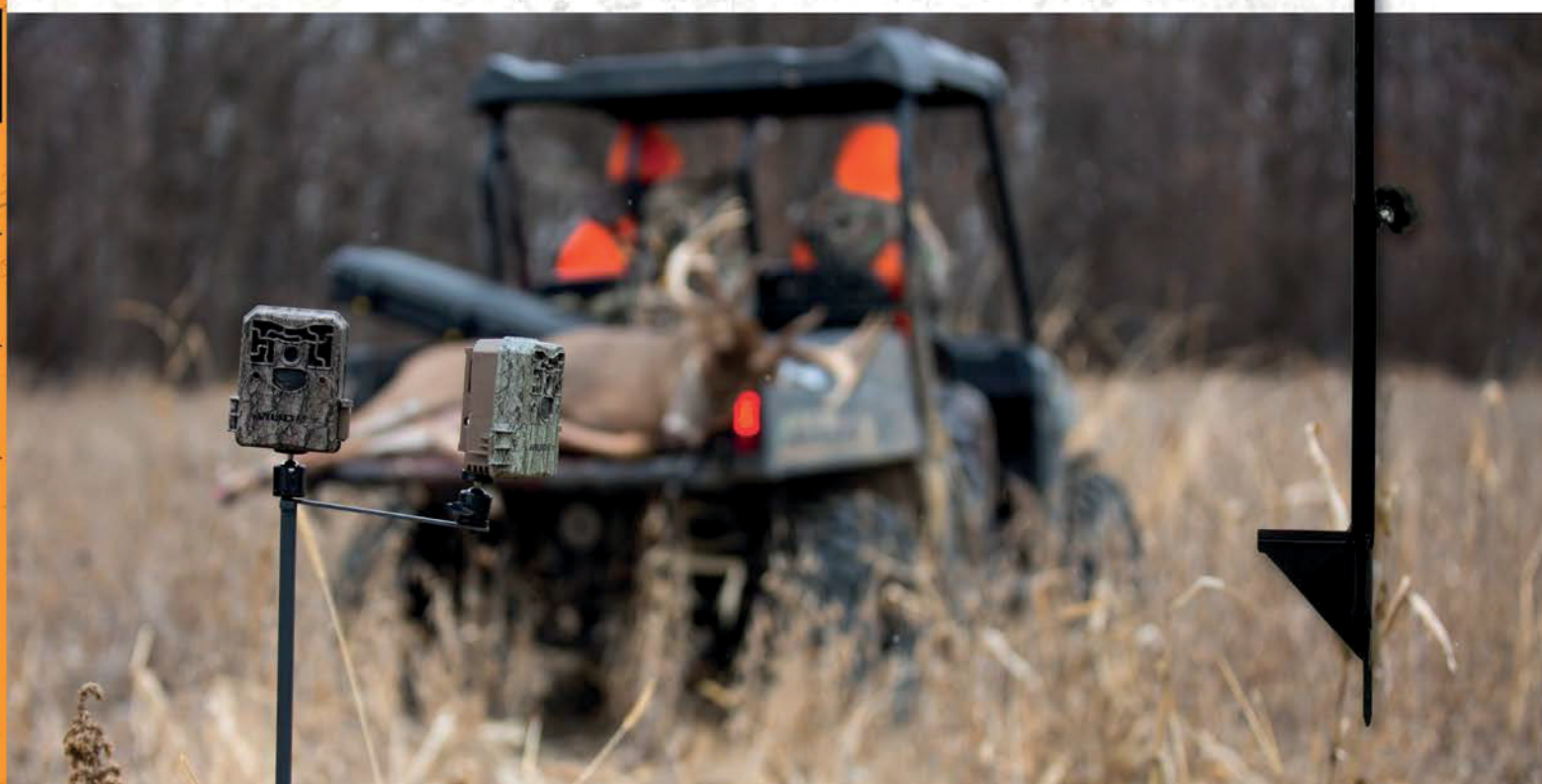

COMPARISON CHART



PRO-CAM EO



PRO-CAM I4

Camera Specifications	MTC600	MTC200
Image Resolution	20 MP (Day), 5 MP (Night)	14 MP (Day), 2 MP (Night)
Image Detail: Color (Day), B/W (Night)	✓	✓
Illumination	Invisible Flash with 36 HE LEDs	Invisible Flash with 18 HE LEDs
Trigger Speed	0.6 Seconds	1.5 Seconds
Burst Interval	2 Seconds or 0.6 Seconds	2 Seconds
Image Data: Camera ID, Date, Time, Temp, & Moon Phase	✓	✓
Video Mode	1280 x 720 HD with Sound or VGA (32 FPS) with Sound	Standard VGA (32 FPS)
Video Length	6 Options: 5 Sec - 2 Minutes (Day), 10 sec (Night)	4 Options: 10 - 60 seconds (Day), 10 sec (Night)
Detection Range	70 Feet	50 Feet
Flash Range	70+ Feet	50+ Feet
Field of View: 3 Zone + 50° Detection Angle	✓	✓
Camera Options - Beyond Optimal Presets		
Photo Burst	2 - 8 Photos	2 - 6 Photos
Trigger Delay	Options from 2.5 Seconds - 60 Minutes	Options from 10 Seconds - 30 Minutes
Time-lapse	Yes	-
Time-lapse Period	Custom Start/End Time	-
Time-lapse Frequency	10 Options: 5 Sec. - 60 Min	-
SD Overwrite	Camera will overwrite oldest images on SD card if SD card is full	-
Physical Specs		
Dimensions	4.75" H x 4.25" W x 2.5" D	4.75" H x 4.25" W x 2.5" D
Material	Molded ABS	Molded ABS
Finish	Non-reflective Bark Pattern	Non-reflective Brown
Housing	Waterproof	Waterproof
Settings Screen	Backlit LCD Screen	Backlit LCD Screen
Mounting Options	Adjustable Strap with Buckle	Adjustable Strap with Buckle
Alt. Mounting	1/4" - 20	1/4" - 20
Theft Deterrence	Cable Lock and Padlock Ready	Cable Lock and Padlock Ready
Technical Data		
Battery Life	Up to 10,000 Images	Up to 10,000 Images
Batteries Required	6 AA	6 AA
Alt. Power Option	12V DC	12V DC
Memory Card	Secure Digital Up to 32 GB	Secure Digital Up to 32 GB
Product Warranty	1 Year	1 Year
Operating Temp.	-10° F to 140° F	-10° F to 140° F



QUAD

HEIGHT	12' TALL
DIMENSIONS	57" x 57" PLATFORM
ENTRANCE	2-RAIL LADDER
SEAT	18"W x 14"D SWIVELS 360°
WEIGHT RATING	500 LBS.

MODEL MQP1600

(*Additional freight or handling may apply; oversize/overweight carton)



12'
HEIGHT



147" to shooting rail

2 Muddy Flex-tek seats

Steel floor



QUAD BLIND KIT

MODEL MQA1602



Large zippered corner entry

QUAD ENCLOSURE KIT



HEIGHT 84" STANDING HEIGHT

WINDOWS 4; 22"W x 28"H

MODEL MQA1601

4 x Zippered windows

7' standing height

Large zippered corner entry



NOMAD

HEIGHT	12' TALL
DIMENSIONS	19" DIAMETER PLATFORM
ENTRANCE	SINGLE RAIL LADDER
STAND WEIGHT	67 LBS.
WEIGHT RATING	300 LBS.

MODEL MTP8100

12'
HEIGHT

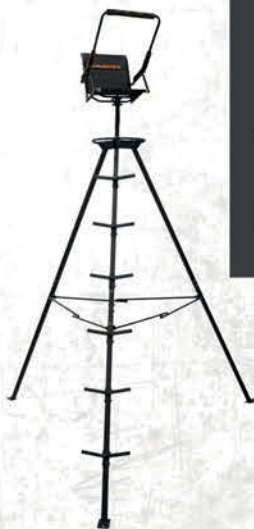

12 ft to shooting rail

Muddy Flex-tek seat

360-degree rotating seat

Easy fold up for transport

Steel construction

36" high, padded, shooting rail



LIBERTY

HEIGHT	16' TALL
FOOT PLATFORM	42" DIAMETER
SEAT	18"W x 14"D SWIVELS 360°
STAND WEIGHT	132 LBS.
WEIGHT RATING	300 LBS.

MODEL MTP3000

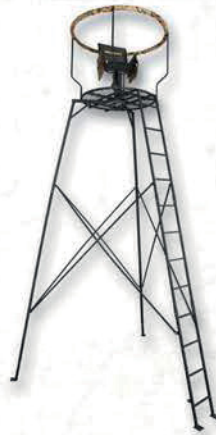

16'
HEIGHT



Padded shooting rail

Padded armrests with gear bags

Extremely wide & comfortable 360° Flex-tek seat

Flared-out shooting rail for extra room

Wide expanded metal grates

Adjustable legs for uneven ground



2x detachable gear bags



THE ENCLOSURE KIT FOR LIBERTY

MODEL MTA3000-RK

- CONSTRUCTION: Steel/water-resistant quiet denier fabric in Epic Camo
- WINDOWS: 8 Zippered windows
- ENTRANCE: 21"W x 25"H
- INTERIOR: Tall enough to stand
- COVER: Full surround
- FASTENERS: Bungee cords
- TOTAL KIT WEIGHT: 24 LBS.

THE 4 FOOT EXTENSION FOR LIBERTY

MODEL MTA3004-EX

- CONSTRUCTION: Steel
- USE: Raises Liberty height to 20'
- SET UP: Easy to install
- STAND WEIGHT: 38 LBS.
- WEIGHT RATING: 300 LBS.

MADE TO FIT BLIND KIT IV

MODEL MCB-MF4

- CONSTRUCTION: Water-resistant quiet denier fabric in Epic Camo
- FOR USE WITH: The Liberty Tripod - Model MTP3000 (This blind may fit future stands as well, see stand box for more details.)
- ENTRANCE: 25" x 25" Zippered closure
- FASTENERS: Snaps & bungee cords



GROUND BLINDS

"I picked my daughter Brooke up from school and we were off to the Muddy ground blind. Spacious and easy to setup, we were comfortable which makes the Muddy blinds perfect for both kids and adults. As the sun started to set Brooke noticed movement to our left and a huge buck stepped out. Brooke made a perfect shot!"

-Jason Kephart

The Kindred Life



V\$360™

HEIGHT	19.5 LBS.
SHOOTING WIDTH	77"W x 77"D
STANDING HEIGHT	70"
STYLE	HUB

MODEL MGB2000



"I pulled it out of the box yesterday and took it hunting. It fooled the turkey as he came into 7 yards! The window system is flawless when it comes to bow hunting." - Bucks



Weather resistant black-backed Epic camo fabric

Sliding shoot-through mesh over all windows for 360° viewing & shooting

4 Tie down straps for added security

Hub-style frame for quick put up and take down

Bottom wind flaps



RAVAGE™

WEIGHT	18.5 LBS.
SHOOTING WIDTH	72"W x 72"D
STANDING HEIGHT	64"
STYLE	HUB

MODEL MGB0500

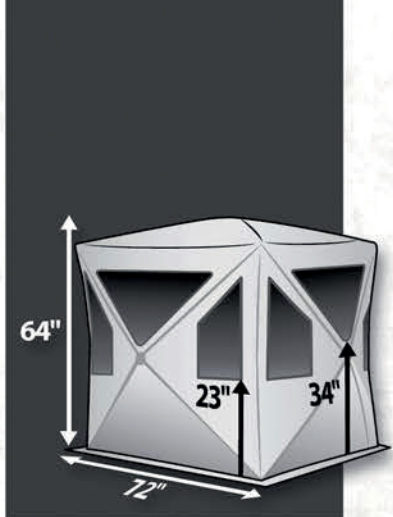

Silent, one-hand release hooks for window adjustment



Standard carry bag included



2 interior Gear pockets



Completely blacked-out interior

4 Tie down straps for added security

Hub-style frame for quick put up and take down



BALE BLIND

CONSTRUCTION	POWDER-COATED STEEL COVERED WITH BLACK-BACKED, WATER-RESISTANT DENIER FABRIC + BURLAP
SHOOTING WIDTH	82" W X 64" L
STANDING HEIGHT	73"
WATERFOWL OPENING	64" W X 27" T, ONE-HAND USE
HEIGHT FROM THE BOTTOM OF THE WINDOWS	32"
WEIGHT	90 LBS.

MODEL MGB6000

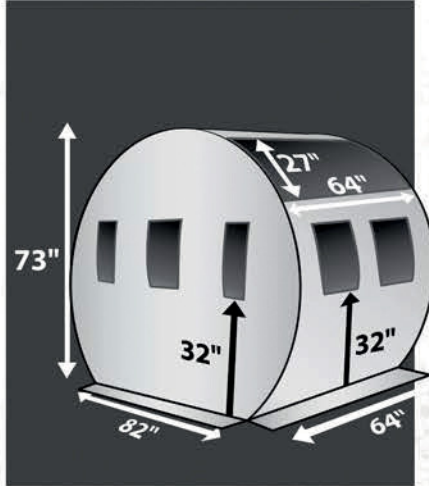

- REVERSIBLE WINDOWS
- CONCEALMENT FROM THE ELEMENTS
- WEATHER RESISTANT MATERIAL
- BLACKED-OUT INTERIOR



"Enjoy the simplicity of this product and how all the features are integrated from the windows to the door placement. One of the most fundamentally sound constructed Blinds I have hunted from. Overall another well-constructed product from Muddy." - Rodney



SPACIOUS, FEATURE PACKED, AND A PERFECT BLEND WITH THE SURROUNDINGS!

Reversible windows with camo on one side & black on the other allow hunters to have the same looking blind whether the windows are open or closed. Professional hunters know that game is easily spooked when details in their environment change.

Waterfowl drop down window, easy one-hand operation

Windows are reversible, slide easily on bungees

64" W x 27" T Waterfowl Window

4 windows 6"W x 16"T

6 windows 12"W x 16"T

Bottom wind flaps +4 steel stakes included



EASY-ACCESS DOOR
Large zippered door with window

BRUSH STRIPS
Brush ties & brush strips throughout the blind





SWIVEL-EASE XTREME

CONSTRUCTION	STEEL FRAME
MATERIAL	FLEX-TEK SEAT
WEIGHT	16 LBS.
WEIGHT RATING	300 LBS.
FEATURES	FOOTREST, SWIVELS 360°

MODEL MGS600



SWIVEL-EASE GROUND SEAT

Armrests for all day comfort

Removable carry strap

CONSTRUCTION	STEEL FRAME
MATERIAL	FLEX-TEK SEAT
WEIGHT	15 LBS.
WEIGHT RATING	300 LBS.

MODEL MGS400



Folds compact for easy carrying

Wide base for increased stability



FOLDING TRIPOD GROUND SEAT

CONSTRUCTION	STEEL FRAME
MATERIAL	HEAVY-DUTY, WATER-RESISTANT FABRIC
FEATURES	PADDED SEAT, CONTOURED BACKREST, CARRY STRAP, FOLDS FLAT FOR STORAGE
WEIGHT	6.5 LBS.
WEIGHT RATING	250 LBS.

MODEL MGS300

DELUXE STADIUM CHAIR



- SEAT: 22" WIDE X 16.5" DEEP; 3" THICK
- BACKREST: 22" WIDE X 16.5" TALL; 3" THICK
- FEATURES: BUILT-IN ARMRESTS AND BENCH SEAT AND EASY TRANSPORTATION
 - ADJUSTABLE PADDED BACKPACK STRAPS
 - ATTACHES TO ANY 5 OR 6 GALLON BUCKET
 - MULTIPLE COMFORT ADJUSTMENT SETTINGS
- WEIGHT: 8.5 LBS

*BUCKET SOLD SEPERATELY

MODEL GS1206

SPORTSMAN'S BUCKET



5 GALLON PAIL: SWIVEL SEAT COVER

- FEATURES: CAMO PAIL COVER WITH POCKETS AND CARRY STRAP

MODEL GS1205

SPIN-TOP BUCKET



5 GALLON PAIL: SWIVEL SEAT COVER

MODEL GS1204

WATERPROOF SEAT COVER

- ADJUSTABLE TO 23" X 16"
- WATERPROOF
- FITS MOST FIXED POSITION TREESTANDS
- FASTENERS: ELASTIC BAND & ADJUSTABLE CORD LOCK



MODEL CR86-V

SPRING BACK LUMBAR SUPPORT

- USE WITH ANY TREESTAND OR AT GROUND LEVEL FOR EXTRA BACK SUPPORT
- MATERIAL: SPRING STEEL FRAME, BLACK MESH
- FASTENERS: ADJUSTABLE STRAPS; FITS UP TO 34" TREE



MODEL AC200



PORTABLE HOT SEAT



- CONSTRUCTION: DURABLE CAMOUFLAGE CUSHION RETAINS & REFLECTS YOUR OWN BODY HEAT FOR A WARM, COMFORTABLE SEAT
- SIZE: 15" DIAMETER X 4" THICK

MODEL GS0105

SWIVEL SEAT



- 5-GALLON PAIL SWIVEL SEAT TOP: 1" THICK ROTATING CUSHION SNAPS ONTO ANY STANDARD 5-GALLON PAIL CREATING A COMFORTABLE SEAT FOR HUNTING.

MODEL GS0205



ULTRA TREE SEAT

- DELIVERS MOBILITY AND COMFORT WITH THE FLEX-TEK SEAT DESIGN
- CONVENIENT AND COMFORTABLE WAY OF HUNTING FROM THE GROUND
- EXTREMELY PORTABLE

MODEL MTS500

ULTRA PLUSH SEAT



- CONSTRUCTION: DURAFOAM; MAKES THIS SEAT CUSHION FIRM YET ULTRA-PLUSH FOR ALL-DAY COMFORT.
- WATERPROOF EPIC CAMO
- SIZE: 16" WIDE X 14" DEEP X 3" THICK
- 1.5" WIDE CARRY STRAP

MODEL GS0109

COMPLETE SEAT

- SEAT CUSHION: 18" WIDE X 14" DEEP; 3" THICK IN FRONT TO 2" THICK IN REAR
- BACKREST: 14" WIDE X 17" TALL; 1.5" THICK
- SUPPORT STRAPS: STRAPS CAN BE USED TO SUPPORT THE BACKREST AS A FREESTANDING SEAT OR CAN BE USED TO SECURE BACKREST AROUND TREE; CARRY STRAP INCLUDED
- WEIGHT: 2 LBS.

MODEL GS1105



UNIVERSAL SHOOTING RAIL



- SHOOTING RAIL FLIPS UP & OUT OF THE WAY
- BACKREST CUSHION: 14" WIDE X 8" TALL X 2" THICK
- FOR USE WITH: MOST FIXED POSITION TREESTANDS, BLIND KIT FOR UNIVERSAL SHOOTING RAIL - MODEL CR0095 (SOLD SEPARATELY)
- FASTENERS: ONE 1" RATCHET STRAP
- WEIGHT: 7 LBS.

MODEL CR0090

STANDARD SEAT CUSHION



- 18" WIDE X 10" DEEP X 2" THICK
- FITS ON MOST TREESTANDS
- FASTENERS: SILENT TIES

MODEL CR87-V

MULE GAME CART

CONSTRUCTION	STEEL
DIMENSIONS	16"W x 40"L
WHEEL	16" DIAMETER, HARDENED RUBBER
WEIGHT	29 LBS.
WEIGHT RATING	300 LBS.

MODEL MGC400

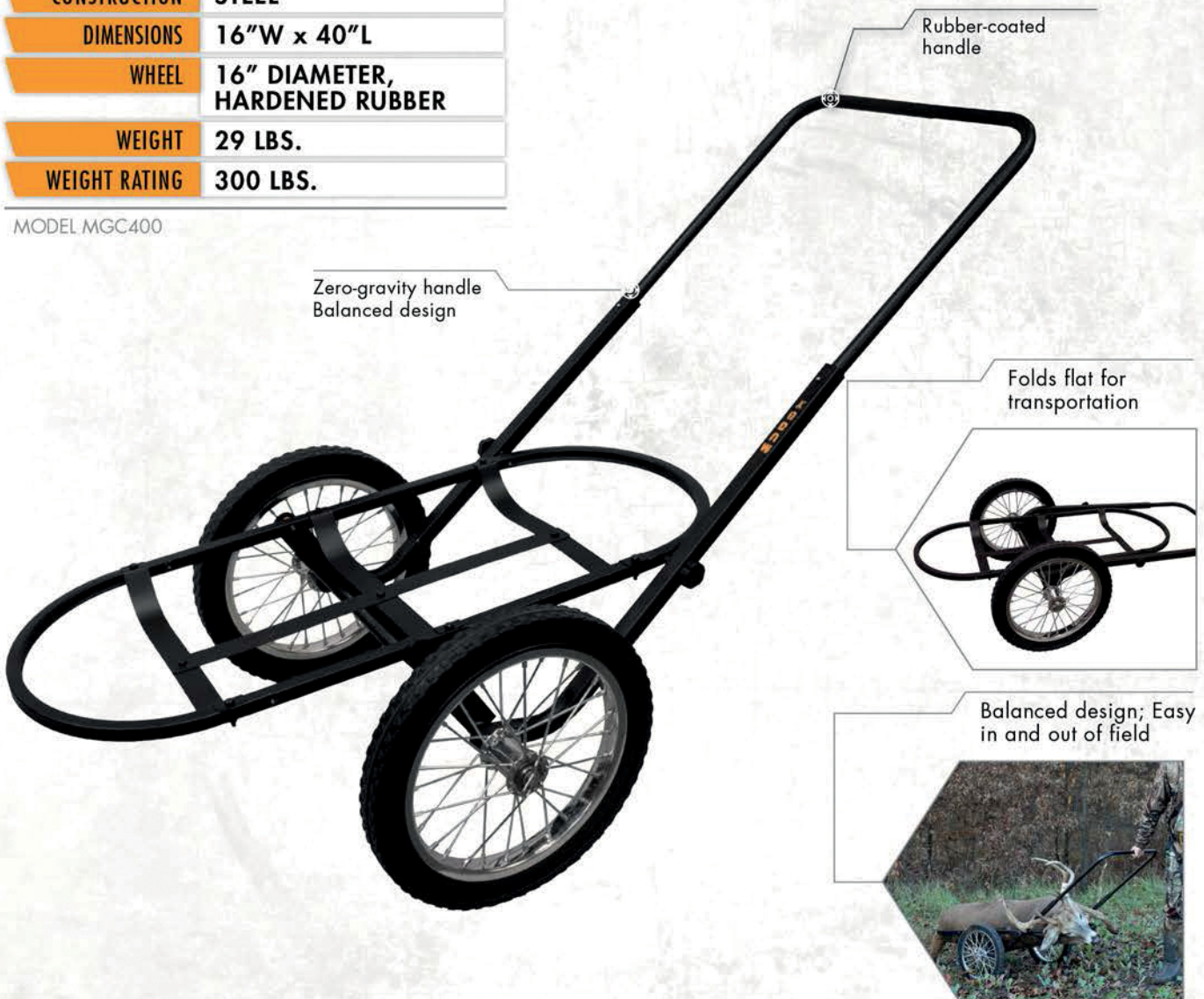



OUTFITTER CAMERA ARM

SIZE	4"W X 14"T X 40"L (WITH FULL ARM EXTENSION)
CONSTRUCTION	STEEL, EXTREMELY QUIET JOINTS & PIVOTS
MECHANICS	EASY LEVELING + QUICK RELEASE LEVER + 360° EXTENDABLE ARM = PERFECT CAMERA ANGLE
PACKABLE	EASILY PACKABLE & SETS UP IN SECONDS!
FEATURES	2 DIFFERENT CAMERA BOLT SIZES, BUBBLE LEVEL, QUICK RELEASE LEVER ADJUSTMENTS, & QUIET LOOP-END RATCHET STRAP
WEIGHT	4.5 LBS.

RATED FOR:
10 LBS.

MODEL MCA200



"This camera arm has covered all the basics. It's solid, light-weight, easy to set up, smooth, and quiet!" – JD

THE OUTFITTER CAMERA ARM BASE

MODEL MCA202

- WEIGHT: 2 Lbs.
- EASY TO INSTALL
- SOLID LOCK LEVELING SYSTEM ELIMINATES ARM SLIPPAGE

(BASE ONLY. OUTFITTER ARM SOLD SEPARATELY.)



HUNTER CAMERA ARM

SIZE	4"W X 14"T X 46"L (WITH FULL ARM EXTENSION)
CONSTRUCTION	STEEL, EXTREMELY QUIET JOINTS & PIVOTS
MECHANICS	46" REACH WITH OVER 5 POINTS OF ADJUSTMENT
PACKABLE	EASILY PACKABLE & SETS UP IN SECONDS!
FEATURES	EASY GRIP CAMERA TIGHTENING KNOB, BUBBLE LEVEL, SPRING-LOADED LEVER ADJUSTMENT, & RATCHET STRAP
WEIGHT	7 LBS.

RATED FOR:
15 LBS.

MODEL MCA400

THE HUNTER CAMERA ARM BASE

MODEL MCA402

- WEIGHT: 5 Lbs.
- HEAVY-DUTY CAMERA ARM BASE WITH UNLIMITED ADJUSTMENTS

(BASE ONLY. HUNTER ARM SOLD SEPARATELY.)



BASIC CAMERA ARM

- ADJUSTABLE CAMERA ARM FEATURES A QUICK-RELEASE MOUNT FOR CONVENIENCE!
- FOREARM & CAMERA HEAD ADJUST A FULL 360°
- EXTENSION ARM SWINGS 180°
- LIGHTWEIGHT DESIGN FOR EASY TRANSPORT
- WEIGHT RATING: 4 Lbs.

MODEL MCA100



HUNT HARD CAMERA ARM

NEW

SIZE	14"W X 12"T X 24"L (WITH FULL ARM EXTENSION)
CONSTRUCTION	ALUMINUM, QUIET JOINTS & PIVOTS
MECHANICS	24" REACH WITH OVER 5 POINTS OF ADJUSTMENT
PACKABLE	EASILY PACKABLE & SETS UP IN SECONDS!
FEATURES	EASY GRIP CAMERA TIGHTENING KNOB, BUBBLE LEVEL, & RATCHET STRAP
WEIGHT	5 LBS.

RATED FOR:
6 LBS.

MODEL MCA150



XTREME SHOOTING BENCH

BENCH TOP	23"W x 34"L, PADDED TOP WITH COATED STEEL RAISED LEDGE
SEAT	12"W x 14"D x 2" THICK
SWIVEL ACTION	SEAT & TOP SWIVEL TOGETHER OR INDEPENDENTLY 360°
WEIGHT	46 LBS.
WEIGHT RATING	300 LBS.

MODEL MSB500

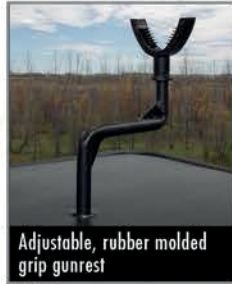

SWIVEL-ACTION SHOOTING BENCH

BENCH TOP	29"W x 29"L, EXTENDED ARMRESTS
SEAT	12"W x 14"D x 2" THICK
SWIVEL ACTION	SEAT & TOP SWIVEL 360°
WEIGHT	38 LBS.
WEIGHT RATING	300 LBS.

MODEL MSB300



ULTRA-STEADY SHOOTING BENCH

BENCH TOP	21"W x 28"L,
SEAT	12"W x 14"D x 2"T
WEIGHT	32 LBS.
WEIGHT RATING	300 LBS.

MODEL MSB100



RUBBER WIRE

- 25' LONG RUBBER WIRE IS REUSABLE AND WORKS IN LIMITLESS PLACES FOR ANY SPORTSMAN!
- DURABLE STEEL WIRE IS RUBBER COATED, RUST FREE
- EASY TO USE EVEN WITH A GLOVED HAND AND DOES NOT SCRATCH GEAR
- USE FOR:
 - Tangle-Free treestand hoist rope
 - Securing homemade blinds
 - Securing gear on ATVs and boats
 - Much, much more!



MODEL MTA-RW01

TREESTAND BACKPACK STRAPS

- QUICK & EASY TO ATTACH & USE
- ADJUSTABLE, PADDED STRAPS
- FITS MOST TREESTANDS



MODEL MTA-BPS01

EZ. TWIST PULL UP ROPE



- 25' LONG FLAT, TANGLE-FREE DESIGN
- SILENT, EZ TWIST-TIE, RUBBER-COATED END
- EASY TO USE EVEN WITH A GLOVED HAND AND DOES NOT SCRATCH GEAR
- FOLDS UP FLAT AND SMALL FOR STORAGE

MODEL MTA-PR01

EZ. REACH TREESTAND ORGANIZER



- ORGANIZE YOUR GUN, BOW OR CROSSBOW
- 360° ADJUSTMENT, VINYL COATED HOOKS + 2 EXTRA ACCESSORY HOOKS
- UNIVERSAL MOUNT FOR CLIMBERS, FIXED-POSITION OR LADDERSTANDS

MODEL MTA-OR01

LADDERSTAND INSTALLATION HOIST

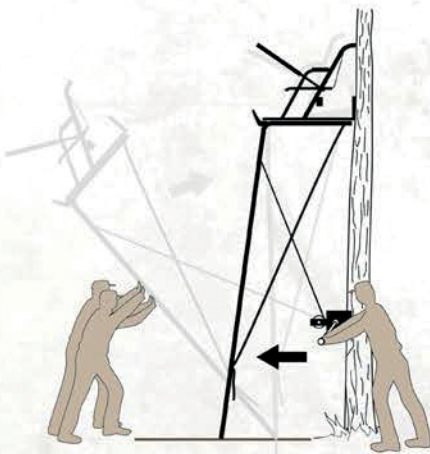

SYSTEM TO SIMPLIFY THE PHYSICAL DEMAND OF INSTALLING LADDERSTANDS

- CONSTRUCTION:
 - Solid steel winch & winch bracket
 - 25' Heavy-Duty Winch Strap
 - Nylon Tether-Strap
 - 1.5" Nylon Ratchet Strap
 - Ladder ground spikes



MODEL MIT-LS02



EXTREME MULTI-HANGER COMBO

- 20" STEEL HANGER + 4" RUBBER COATED STEEL DOUBLE HOOK
- VINYL COATED MAIN HOOK ON PIVOTING ARM + THREE SMALL GEAR HOOKS
- SUPPORT LEG FOR EXTREME STRENGTH
- WEIGHT LIMIT: STEEL HANGER - 30 LBS.; DOUBLE HOOK - 10 LBS.



MODEL BH200-C

EXTREME MULTI-HANGER

- 20" STEEL HANGER
- SCREWS INTO TREE + SUPPORT LEG FOR EXTREME STRENGTH
- COATED MAIN HOOK ON PIVOTING ARM + THREE SMALL HOOKS
- WEIGHT LIMIT: 30 LBS.

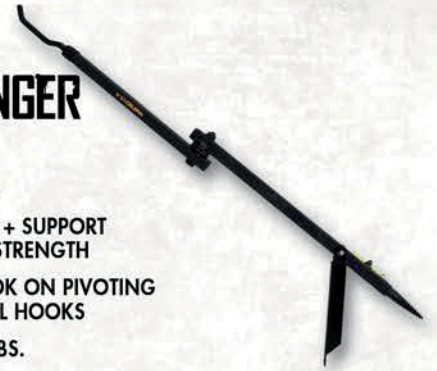

MODEL BH200

GROUND BLIND MINI-BOW HANGER - 2PK

- RUBBER-COATED, 2-SIDED HOOK, 360° ROTATION
- KEEPS YOUR BOW WITHIN EASY REACH
- EASILY CONNECTS TO HUB-STYLE GROUND BLIND FRAME



MODEL GBA-BH01-2

MULTI-HOOK ACCESSORY HOLDER



- 4 ADJUSTABLE GEAR HOOKS
- WEIGHT LIMIT: 50 LBS.

MODEL CR93-V

DELUXE TARGET HOLDER

- CONSTRUCTION: SOLID STEEL FRAME
- DUAL PURPOSE STAND; WORKS FOR BAG* (UP TO 34" TALL X 34" WIDE) OR 3D TARGETS*
- ADJUSTABLE FROM 4" TO 35" TO ACCOMMODATE MOST 3D TARGETS
- WORKS ON MOST GROUND SURFACES
- NO TOOLS NECESSARY FOR ASSEMBLY

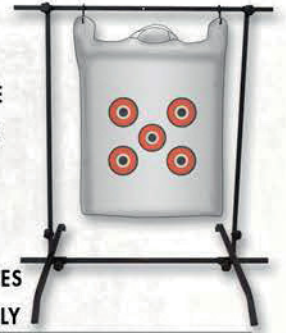

MODEL SA100

*Bag & 3D Targets sold separately

TREE-MOUNT ACCESSORY BASKET

- 8.5" DIAMETER X 9" DEEP
- CONSTRUCTION: SOLID STEEL FRAME WITH DURABLE CAMO MESH
- SCREWS INTO TREE
- WEIGHT LIMIT: 10 LBS.



MODEL TA035

UNIVERSAL PLATFORM BOW HOLDER



- FULLY ADJUSTABLE
- COATED, STEEL FORK
- EASILY ATTACHES TO MOST TREESTANDS

MODEL CR95-V

EZ. ACCESS TREESTAND BASKET

- 12" LONG X 6" WIDE X 8" DEEP
- CONSTRUCTION: SOLID STEEL FRAME WITH DURABLE CAMO MESH
- BUILT-IN CUP HOLDER
- WEIGHT LIMIT: 20 LBS.



MODEL TA030

SCREW-IN DRINK HOLDER RING

- STEEL RING WITH STRONG CAMO MESH HOLDER
- SCREWS INTO TREE
- WEIGHT LIMIT: 10 LBS.



MODEL CR70-V



SCREW-IN ACCESSORY HOOK 50 PK

- RUBBER COATED STEEL HOOK
- SCREWS INTO TREE
- 50-COUNT RETAILER PACK FOR INDIVIDUAL SALE
- WEIGHT LIMIT: 10 LBS.*



MODEL BH050

SCREW-IN ACCESSORY HOOKS 3 PK

- RUBBER COATED STEEL HOOK
- SCREWS INTO TREE
- WEIGHT LIMIT: 10 LBS.*



MODEL BH002-3

DOUBLE ACCESSORY HOOKS 24 PK

- 4" RUBBER COATED STEEL DOUBLE HOOK
- SCREWS INTO TREE
- 24-COUNT RETAILER PACK FOR INDIVIDUAL SALE
- WEIGHT LIMIT: 10 LBS.*



MODEL BH004-24

LONG ACCESSORY HOOK

- EXTRA LONG RUBBER COATED STEEL HOOK
- SCREWS INTO TREE
- WEIGHT LIMIT: 10 LBS.*



MODEL BH001

TRIPLE ACCESSORY HOOK

- 3 HOOKS IN 1; RUBBER COATED STEEL
- SCREWS INTO TREE
- 12-COUNT RETAILER PACK FOR INDIVIDUAL SALE
- WEIGHT LIMIT: 10 LBS.*



MODEL BH003

SINGLE SCREW-IN HOOK

- FOLDS DOWN TO 4.25" FOR STORAGE
- CARABINER FOR PORTABILITY AND EXTRA HOOK FOR GEAR
- STEEL TIP FOLDS AND LOCKS INTO PLACE FOR SAFE STORAGE



MODEL MTA-MH01

MAGNUM BOW HOLDER

- RUBBER FORK SWIVELS 360° FOR PRECISE POSITION
- EXTRA-LONG STAKE FOR STABILITY
- LIGHTWEIGHT FOR TRANSPORT



MODEL BH100

MULTI-HANGER

- 23" SCREW-IN STEEL HANGER
- VINYL COATED MAIN HOOK ON PIVOTING ARM + PIVOTING GEAR TABS
- WEIGHT LIMIT: 20 LBS.



MODEL CR94-V (SINGLE) | MODEL CR94-V3 (3 PACK) | MODEL BH012 (12 PACK)



MULTI-HANGER



- 11" 2-WAY ADJUSTABLE ARM EXTENSION ROTATES 270°
- 6" NON-SLIP GRIP RUBBER-COATED HOOK ROTATES 360°
- 3 SEPARATE KNOBS FOR EXTRA GEAR
- LEG GRIP FOR EXTRA STRENGTH

MODEL MTA-MH03

EXTREME MULTI-HANGER



- 2-WAY PIVOTING AXIS ARM ROTATES 360°
- NON-SLIP GRIP RUBBER-COATED HOOK ROTATES 360°
- 2 SEPARATE KNOBS FOR EXTRA STORAGE
- LEG GRIP FOR EXTRA STRENGTH

MODEL MTA-MH05

TELESCOPING MULTI-HANGER



- FOLDS DOWN TO 8.75" FOR STORAGE
- HOOK ARM ADJUSTS 360°
- LEG GRIP FOR EXTRA STRENGTH
- EASY INSTALLATION WITH SCREW-IN STEEL TIP

MODEL MTA-MH04

TWO PIVOTING AXIS HANGER



- 2" SINGLE J-HOOK WITH 40-LB CAPACITY
- DUAL 6.5" NON-SLIP GRIP RUBBER COATED HOOKS WITH 10-LB WEIGHT LIMIT EACH
- HOOK ARMS ADJUST 180°
- FOLDS DOWN TO 8" FOR STORAGE

MODEL MTA-MH02

COMPLETE STAND KIT NEW



- (1) 23" SCREW-IN STEEL HANGER (WEIGHT LIMIT: 20 LBS.)
- 30' LIFT CORD WITH (2) HEAVY-DUTY CARABINER CLIPS
- (2) RUBBER COATED STEEL HOOKS (WEIGHT LIMIT: 10 LBS.)

MODEL MA9045

TREESTAND MULTI-PURPOSE BOTTLE



- 26 OZ. LEAK PROOF CONTAINER
- SCREWS INTO TREE; INCLUDES TWO RINGS FOR 2 STAND LOCATIONS

MODEL CR81-V

REFLECTIVE SCENT HANGERS

- 6-PACK OF 4" ABSORBENT SPLIT FELT WICKS
- ORANGE REFLECTIVE STRIP
- FITS AROUND BRANCH TO DISTRIBUTE SCENT



MODEL SW100



REFLECTIVE TRAIL MARKING TACKS

ORANGE



WHITE



- VISIBLE UP TO 200 YARDS
- 50 PACK

MODEL TM010 (ORANGE) & CR91-V (WHITE)

REFLECTIVE MARKING TAPE



- BRIGHT ORANGE FOR HIGH VISIBILITY
- 1 ROLL: 1" WIDE X 150' LONG

MODEL CR67-V

REFLECTIVE TRAIL MARKERS



- 10-PACK, REFLECTIVE VINYL 3" STRIPS WITH CLIPS

MODEL CR76-V

LIFT CORD



- 30' NYLON ROPE WITH 2 HEAVY-DUTY CARABINER CLIPS
- HOISTS GUN, BOW, BACKPACK & OTHER GEAR SAFELY INTO STAND

MODEL LA050

TREESTAND RATCHET STRAP



- 1" WIDE X 8' LONG STRAP
- 2 STEEL HOOKS
- GREAT FOR STRAPPING MATERIALS TO TRUCKS, TRAILERS, OR ATVS

MODEL CR99-V (SINGLE PACK) & CR99-V3 (3 PACK)

CAM BUCKLE STRAPS - 3 PK



- 1" WIDE X 8' LONG STRAP
- 2 VINYL-COATED STEEL HOOKS
- WEIGHT LIMIT: 400 LBS.

MODEL TA025-3

HEAVY-DUTY 6' RATCHET STRAP



- 2" WIDE X 6' LONG STRAP
- 2 VINYL-COATED STEEL HOOKS

MODEL TA020

DELUXE UNIVERSAL BLIND KIT

- SIZE: 32" H X 100" L
- FOR USE WITH: ANY ELEVATED STAND WITH A SHOOTING RAIL OR AS AN INDEPENDENT BLIND AT GROUND LEVEL. QUICK AND EASY INSTALLATION. TWO SECTIONS VELCRO TOGETHER IN THE CENTER AND TIE TO SECURE.
- FASTENERS: TIES
- CARRY BAG: INCLUDED



MODEL CA100

THE UNIVERSAL UMBRELLA



- SIZE: 48" SQUARE
- CONSTRUCTION: HUB-STYLE DESIGN FOR QUICK SET-UP; DURABLE, WEAR RESISTANT FABRIC
- CARRY CASE: INCLUDED
- FOR USE WITH: MOST MUDDY TREESTANDS
- FASTENERS: 2 SUPPORT STRAPS

MODEL CR5055

THE POP-UP UMBRELLA



- SIZE: 54" WIDE X 49" DEEP
- CONSTRUCTION: HUB-STYLE DESIGN FOR QUICK SET-UP; DURABLE, WEAR RESISTANT FABRIC
- CARRY CASE: INCLUDED
- FOR USE WITH: MOST MUDDY TREESTANDS
- FASTENERS: SIX 39" SNAP-ON TIE-DOWN STRINGS

MODEL CR5054





NEW

660 LB. DIGITAL SCALE

- EASY TO READ
- MEASURES IN POUNDS, KILOS, & STONES

MODEL GSD660



NEW

DEFENDER SECURITY CABLE

- DURABLE TREESTAND LOCK WITH 5/16" RUBBER COATED 7' CABLE
- 2 KEYS INCLUDED

MODEL MA3531



TREESTAND LOCK

- DURABLE TREESTAND LOCK WITH 1/4" RUBBER COATED 6' CABLE
- 2 KEYS INCLUDED

MODEL CR98-V (SINGLE PACK)
MODEL CR98-V3 (THREE PACK)



330 LB. DIGITAL SCALE

- EASY TO READ
- MEASURES IN POUNDS, KILOS, & STONES

MODEL GSD330



550 LB. DIAL SCALE

- EASY TO READ
- MEASURES IN 2 LB. INCREMENTS

MODEL GS550



STANDARD DEER DRAG

- LIGHT WEIGHT, EASY-TO-USE DEER DRAG

MODEL GP500



DELUXE DEER DRAG

- ADJUSTABLE HARNESS & ROPE DISTRIBUTES WEIGHT FOR REMOVAL OF GAME FROM THE FIELD

MODEL CR77-V



FOLDING SERRATED SAW



- 7" AGGRESSIVE, SERRATED BLADE
- RUBBER COATED HANDLE

MODEL CR73-V

DELUXE RATCHET SHEARS



- CUTS 1" DIAMETER BRANCHES WITH EASE
- 8" HARDENED STEEL SHEARS

MODEL CR72-V

SERRATED HAND SAW WITH SCABBARD



- 10.5" AGGRESSIVE SERRATED BLADE
- PLASTIC SCABBARD WITH BELT LOOP

MODEL CR74-V

EXTENDABLE POLE SAW



- EXTENDS FROM 2.5' TO 6'
- 12" AGGRESSIVE SERRATED BLADE

MODEL CR75-V

FIELD DRESSING GLOVE KIT



- ONE PAIR: ORANGE, SHOULDER LENGTH, TRAIL CLEANING GLOVES
- ONE PAIR: FITTED PRECISION GLOVES
- SANITARY TOWELETTE

MODEL GP100 (SINGLE SET PACK) & GP100-4 (4 SET PACK)

MULTI-PURPOSE CLEANING GLOVES



- GREAT FOR FIELD DRESSING GAME: KNIFE CONTROL, NEXT-TO-SKIN FEEL, LIGHTLY POWDERED & DISPOSABLE
- 20-PACK

MODEL GP120

DELUXE SKINNING TOOL



- LARGE GRIPPING TEETH WITH SCISSOR ACTION
- SMALL OR LARGE GAME

MODEL CR78-V

MAGNA LIFT



- 30' RETRACTABLE NYLON ROPE WITH 2 HEAVY-DUTY CARABINER CLIPS, DURABLE PLASTIC CASE & HEAVY-DUTY STEEL BELT CLIP
- HOISTS GUN, BOW, BACKPACK & OTHER GEAR SAFELY INTO STAND

MODEL ML1000

MAGNUM LIFT SYSTEM



- 4:1 WEIGHT REDUCTION
- AUTOMATIC SELF-LOCKING DEVICE: SINGLE PERSON LIFTING
- WEIGHT RATING: 500 LBS.

MODEL MLS01-V

HEAVY-WEIGHT GAMBREL



- 25" WIDE; 1/2" STEEL BAR WITH HOOKS
- WEIGHT RATING: 1,200 LBS.

MODEL GB12G





	BOSS	BOSS XL	BOSS™ ELITE AL	THE OUTFITTER
MODEL NUMBER	MFP1075	MFP1200	MFP5100-A	MFP3205
CONSTRUCTION	STEEL	STEEL	ALUMINUM	STEEL
FIBER-GUARD COATING	✓	✓	✓	✓
FOOT PLATFORM	24" WIDE X 30" DEEP	25" WIDE X 34" DEEP	20" WIDE X 37" DEEP	24" WIDE X 34" DEEP
FOOT PLATFORM STYLE	D-FORCE EXPANDED	D-FORCE EXPANDED	LYNX EXPANDED	D-FORCE EXPANDED
FOOTREST	FLIPS BACK	FIXED	FLIPS BACK	FLIPS BACK
SEAT SIZE	14" WIDE X 8" DEEP	20" WIDE X 13" DEEP	19" WIDE X 11" DEEP	15" WIDE X 11" DEEP
SEAT STYLE	FLEX-TEK	FLEX-TEK	FLEX-TEK	3" TRI-PLEX FOAM
SEAT FEATURES	FLIPS BACK	FLIPS BACK	FLIPS BACK	WATERPROOF, FLIPS BACK, REMOVABLE
SEAT HEIGHT	21"	22"	14"	24"
ADJUSTABLE ANGLE	-	-	-	FOOT & SEAT PLATFORM
BACKREST	-	-	-	-
SILENCERS: NO METAL ON METAL CONTACT	✓	✓	✓	✓
PACKABLE	✓	✓	✓	✓
DESIGNED TO PACK WITH: OUTFITTER STICKS - MCS100-3, THE PRO STICKS - MCS2000-4, & THE AEROLITE - MCS3000-3A (PG 30-32)	-	-	-	✓
BACKPACK STRAPS INCLUDED	-	-	✓	-
FASTENERS	(1) 2" SILENT SLIDE BUCKLE STRAP	(1) 2" SILENT SLIDE BUCKLE STRAP	SUPER MOUNT plus (1) 1" SILENT CAM-BUCKLE STRAP	(1) 1" SILENT CAM-BUCKLE & (1) 1" LOOPED RATCHET STRAP
PADDED ARMRESTS	-	-	-	-
ACCESSORY BAG	-	-	✓	✓
STAND WEIGHT	18 LBS.	20 LBS.	20 LBS.	22 LBS.
MINIMUM TREE SIZE: 9" DIAMETER	✓	✓	✓	✓
WEIGHT RATING	300 LBS.	300 LBS.	300 LBS.	300 LBS.
FULL-BODY FALL ARREST SYSTEM (WITH CLIMBING BELT)	✓	✓	✓	✓





	QUICK STEP XL	QUICK-STICK XL	ASCENDER	STAGGER STEPS	STAGGER STEPS 3-PK	PRO CLIMBING STICKS	AEROLITE CLIMBING STICKS
MODEL NUMBER	MCS1020	MCS0120	MCS0520	MCS1200	MCS1200-3	MCS2000-4	MCS3000-3A
CONSTRUCTION	STEEL	STEEL	STEEL, DX TUBING	STEEL	STEEL	ALUMINUM	ALUMINUM
FIBER-GUARD COATING	✓	✓	✓	✓	✓	✓	✓
TOTAL HEIGHT (18" BETWEEN SECTIONS, SINGLE SECTIONS MEASURED FROM THE GROUND UP)	20'	20'	20'	-	-	12.5'	12.5'
HEIGHT PER SECTION	48"	48"	48"	31"	31"	20"	32"
SECTIONS	5	5	5	1	3	4	3
SECTIONS CAN BE INSTALLED INDEPENDENTLY	-	-	-	✓	✓	✓	✓
WIDTH	9"	10.5"	11"	9"	9"	9.25"	10"
SILENCERS: NO METAL ON METAL CONTACT	✓	✓	✓	✓	✓	✓	✓
PACKABLE	-	-	-	✓	✓	✓	✓
DESIGNED TO PACK WITH SEVERAL COMPATIBLE FIXED POSITION STANDS	-	-	-	-	-	✓	✓
FASTENERS (PER SECTION)	(1) 1" CAM-BUCKLE STRAP	(1) 1" CAM-BUCKLE STRAP	(1) 1" CAM-BUCKLE STRAP	(1) 1" CAM-BUCKLE STRAP	(1) 1" CAM-BUCKLE STRAP	ROPE CAM ATTACHMENT SYSTEM	(1) 1" SILENT CAM-BUCKLE STRAP
TOTAL WEIGHT	27 LBS.	25 LBS.	33 LBS.	4 LBS.	12 LBS.	10 LBS.	9 LBS.
WEIGHT PER SECTION	5 LBS.	5 LBS.	6.6 LBS.	4 LBS.	4 LBS.	2.5 LBS.	3 LBS.
WEIGHT RATING	300 LBS.	300 LBS.	300 LBS.	300 LBS.	300 LBS.	300 LBS.	350 LBS.





BOSS HAWG 1.5 SKYBOX DELUXE HUNTSMAN HUNTSMAN DELUXE ODYSSEY XTL

MODEL NUMBER	MLS1900	MLS1550	MLS1200	MLS1300	MLS1776
STEEL CONSTRUCTION	✓	✓	✓	✓	✓ DX TUBING
FIBER-GUARD COATING	✓	✓	✓	✓	✓
STAND HEIGHT TO SHOOTING RAIL	17'	20'	17'	17'	20'
FOOT PLATFORM	28" WIDE X 30" DEEP	19" WIDE X 25" DEEP	19" WIDE X 25" DEEP	19" WIDE X 25" V" DEEP	18" WIDE X 26" DEEP
EXPANDED METAL PLATFORM	D-FORCE	D-FORCE	D-FORCE	D-FORCE	D-FORCE
FOOTREST: FLIPS BACK	✓	✓	✓	✓	✓
SEAT SIZE	24" WIDE X 17" DEEP	22" WIDE X 17" DEEP	20" WIDE X 15" DEEP	22" WIDE X 17" DEEP	22" WIDE X 17" DEEP
SEAT STYLE	FLEX-TEK	FLEX-TEK	FLEX-TEK	FLEX-TEK	FLEX-TEK
SEAT HEIGHT	27"	21"	21"	21"	21"
SEAT FEATURES	FLIPS BACK	FLIPS BACK	FLIPS BACK	FLIPS BACK	FLIPS BACK
BACKREST	25" WIDE X 27" TALL	20" WIDE X 14" TALL	20" WIDE X 14" TALL	22" WIDE X 19" TALL	22" WIDE X 19" TALL
SILENCERS: NO METAL ON METAL CONTACT	✓	✓	✓	✓	✓
PADDED ARMRESTS	✓	✓	✓	✓	✓
PADDED, FLIP-BACK SHOOTING RAIL	✓ ADJUSTABLE	✓ 2-WAY ADJUSTABLE	✓ 2-WAY ADJUSTABLE	✓ 2-WAY ADJUSTABLE	✓ 2-WAY ADJUSTABLE
FASTENERS	(1)1" RATCHET STRAP, (2)1" STABILIZER STRAPS	(1)1" RATCHET STRAP, (2)1" STABILIZER STRAPS	(1)1" RATCHET STRAP, (2)1" STABILIZER STRAPS	(1)1" RATCHET STRAP, (2)1" STABILIZER STRAPS	(1)1" RATCHET STRAP, (2)1" STABILIZER STRAPS
ADJUSTABLE SUPPORT BAR	✓	✓	✓	✓	✓
LADDER SECTIONS	(3) SINGLE RAIL BOLTED	(4) DOUBLE RAIL BOLTED	(3) SINGLE RAIL BOLTED	(3) SINGLE RAIL BOLTED	(4) SINGLE RAIL BOLTED
EXTRAS	-	-	-	-	(1) ACCESSORY HOOK (1) DRINK HOLDER
STAND WEIGHT	67 LBS.	73 LBS.	55 LBS.	55 LBS.	75 LBS.
WEIGHT RATING	350 LBS.	300 LBS.	300 LBS.	300 LBS.	300 LBS.
MINIMUM TREE SIZE: 9" DIAMETER	✓	✓	✓	✓	✓
SAFETY HARNESS	1	1	1	1	1
HERCULES SYSTEM	-	-	-	-	✓





STRONGHOLD 1.5 STRONGHOLD 2.5 XTL REBEL 2.5 BIG BUDDY PARTNER NEXUS XTL

MLS1150	MLS2251	MLS2800	MLS2200	MLS2300	MLS2601
✓ DX TUBING	✓	✓ DX & RS TUBING	✓	✓	✓ DX & RS TUBING
✓	✓	✓	✓	✓	✓
21'	18'	17'	16'	17'	20'
27" WIDE X 14" DEEP	50" WIDE X 17" DEEP	45" WIDE X 30" DEEP	38" WIDE X 12" DEEP	40" WIDE X 33" DEEP	42" WIDE X 34" DEEP
D-FORCE	D-FORCE	D-FORCE	D-FORCE	D-FORCE	D-FORCE
✓	✓	-	-	✓	✓
26" WIDE X 18" DEEP	24" WIDE X 17" DEEP	21" WIDE X 17" DEEP	38" WIDE X 17" DEEP	37" WIDE X 18" DEEP	39" WIDE X 17" DEEP
FLEX-TEK	FLEX-TEK	FLEX-TEK	FLEX-TEK	FLEX-TEK	FLEX-TEK
22"	19"	19"	22"	20"	19"
FIXED	-	FLIPS BACK	-	FLIPS BACK	FLIPS BACK
26" WIDE X 19" TALL	24" WIDE X 27" TALL	21" WIDE X 27" TALL	38" WIDE X 18" TALL	37" WIDE X 18" TALL	39" WIDE X 19" TALL
✓	✓	✓	✓	✓	✓
✓	✓	✓	✓	✓	✓
✓	✓	✓ ADJUSTABLE	✓	✓	✓ ADJUSTABLE
(1) 1" RATCHET STRAP, (2) 1" STABILIZER STRAPS	(2) 1" RATCHET STRAPS, (2) 1" STABILIZER STRAPS	(2) 1" RATCHET STRAPS, (2) 1" STABILIZER STRAPS	(1) 1" RATCHET STRAP, (2) 1" STABILIZER STRAPS	(2) 1" RATCHET STRAPS, (2) 1" STABILIZER STRAPS	(2) 1" RATCHET STRAPS, (2) 1" STABILIZER STRAPS
✓	✓	✓	✓	✓	✓
(4) SINGLE RAIL BOLTED	(4) SINGLE RAIL BOLTED	(3) SINGLE RAIL BOLTED	(3) SINGLE RAIL BOLTED	(3) SINGLE RAIL BOLTED	(4) SINGLE RAIL BOLTED
(1) ACCESSORY HOOK (1) DRINK HOLDER	(2) ACCESSORY HOOKS (2) DRINK HOLDERS	(2) ACCESSORY HOOKS (2) DRINK HOLDERS	-	-	(2) ACCESSORY HOOKS (2) DRINK HOLDERS
71 LBS.	106 LBS.	101 LBS.	64 LBS.	88 LBS.	115 LBS.
300 LBS.	500 LBS.	500 LBS.	500 LBS.	500 LBS.	500 LBS.
✓	✓	✓	✓	✓	✓
1	2	2	2	2	2
-	✓	-	-	-	✓





THE VS360™

THE RAVAGE™

THE BALE BLIND

	MODEL NUMBER
	DIMENSIONS
	CONSTRUCTION
	EPIC CAMO
	STANDING HEIGHT
	ZIPPERED ROOF OPENING
	STYLE
	NUMBER OF WINDOWS
HEIGHT TO BOTTOM OF WINDOWS	CORNER WINDOWS
	CENTER WINDOWS
	WINDOW SECURING: REMOVABLE, SHOOT-THROUGH MESH WITH SILENT ONE HAND RELEASE HOOKS TO ADJUST & LOWER
	CARRYING BAG
	2 GEAR POCKETS
	STAKES
	4 TIE-DOWN ROPES (TO SECURE AGAINST WIND)
	TOTAL WEIGHT
	BRUSH STRIPS
	BOTTOM WIND FLAP
	DOOR
	OTHER FEATURES

MGB2000	MGB0500	MGB6000
BLACK BACKED, WATER RESISTANT FABRIC	BLACK BACKED, WATER RESISTANT FABRIC	POWDER-COATED STEEL COVERED WITH BLACK-BACKED, WATER RESISTANT DENIER FABRIC + BURLAP
✓	✓	-
70"	64"	73"
-	-	-
HUB	HUB	BALE
8	12	11
-	23"	-
32" (ALL 4 SIDES)	34"	32" (ALL 4 SIDES), 4 = 6"W x 16"T, 6 = 12"W x 16"T, 1 = 64"W x 27"T WATERFOWL WINDOW
✓	✓	REMOVABLE, ADJUSTABLE BUNGIES TO SLIDE WINDOWS
OVERSIZED DELUXE CARRY TOTE INCLUDED	STANDARD CARRY BAG WITH BACKPACK STRAPS	-
✓	✓	-
(9) STEEL WITH STAKE POCKET	(9) STEEL WITH STAKE POCKET	(4) STEEL
✓	✓	-
19.5 LBS.	18.5 LBS.	90 LBS.
✓	✓	✓
✓	-	✓
EASY ACCESS DOOR WITH FULL-LENGTH ZIPPER	EASY ACCESS DOOR WITH FULL-LENGTH ZIPPER	LARGE ZIPPERED DOOR WITH WINDOW
-	-	REVERSIBLE SHOOTING WINDOWS



#MUDDY MOMENT



Look through our comprehensive collection of hunting & shooting products right away.