



3512-04

500W Peak Power Subwoofer

Parameters

Fs: 31.4 Hz
Qms: 3.173
Cms: 0.157 mm/N
Mms: 163.35 g
Rms: 10.151 kg/s
Vas: 2.58 ft³ (73.1 liters)
Xmax: 0.32 in (8.128 mm)
D: 10.64 in (270.256 mm)
Sd: 88.908 in² (573.6 cm²)
Vd: 28.53 in³ (0.467 liters)
Qes: 0.893
Re: 3.5 Ω
Bl: 11.27 Tm
Prms: 250 Watts
Qts: 0.697
n0: 0.243%
SPLo: 86.06 dB
SPL 2.83V/1m: 89.7 dB

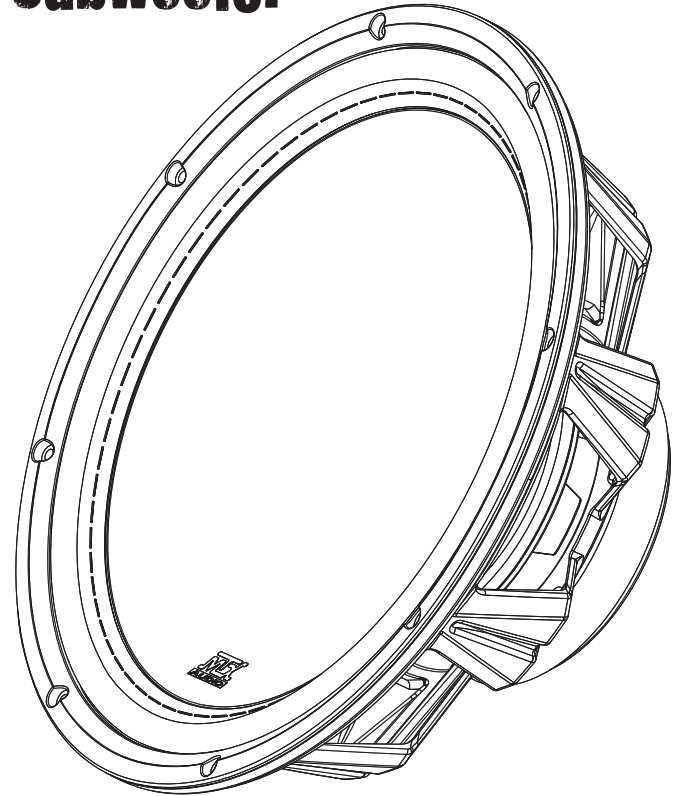

Specifications

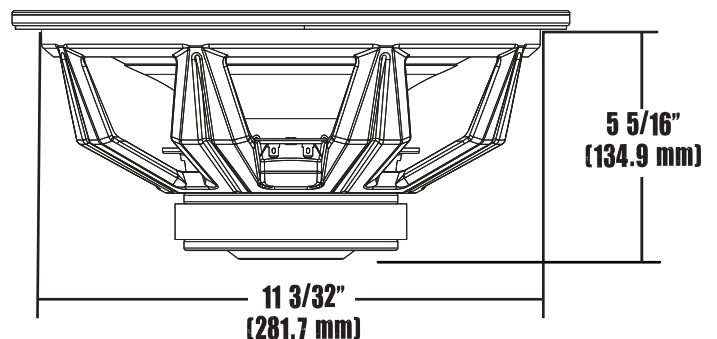
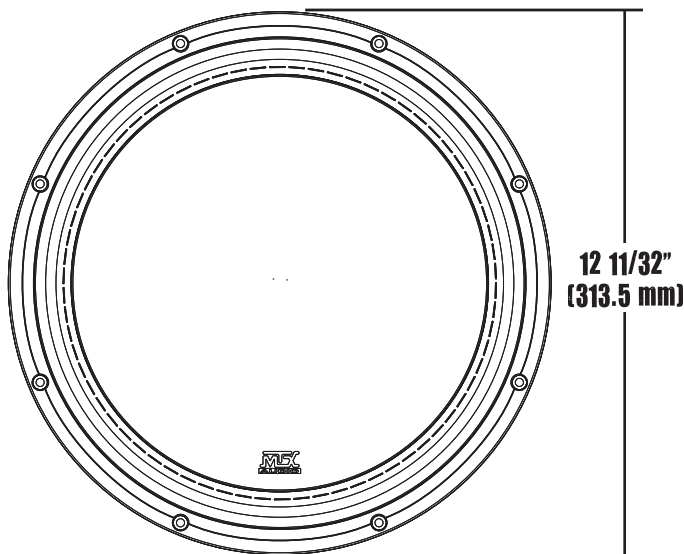

Recommended Power Rating of 125 - 250 Watts RMS

3512-04 Recommended Enclosures

For the best possible sound quality where space is a premium, MTX recommends using a sealed enclosure. For excellent sound quality with increased output compared to sealed enclosures (3dB or more), MTX recommends using a vented enclosure. All recommended enclosures have been designed and thoroughly tested by MTX.

For additional enclosure designs check the MTX website, the barcode will take you to the box design page.

Sealed Enclosure

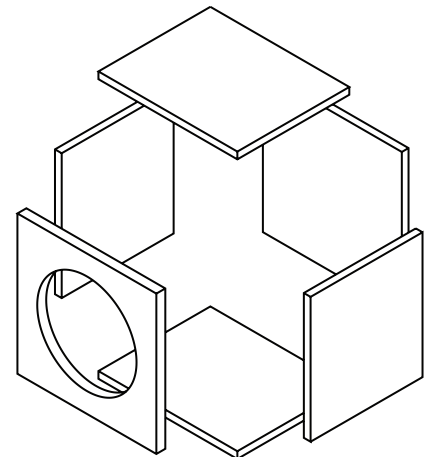
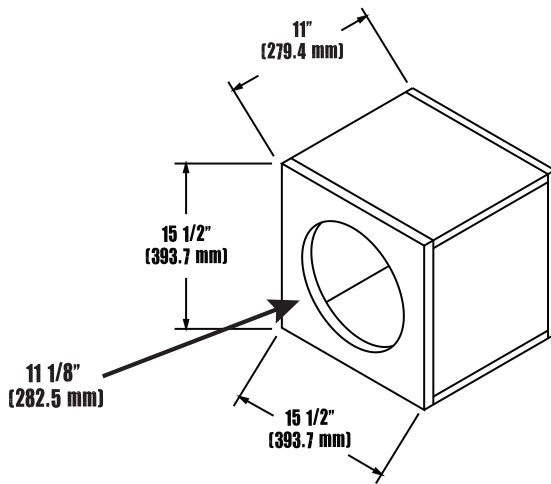

Net Internal Volume: 1.00 ft³

Vented Enclosure

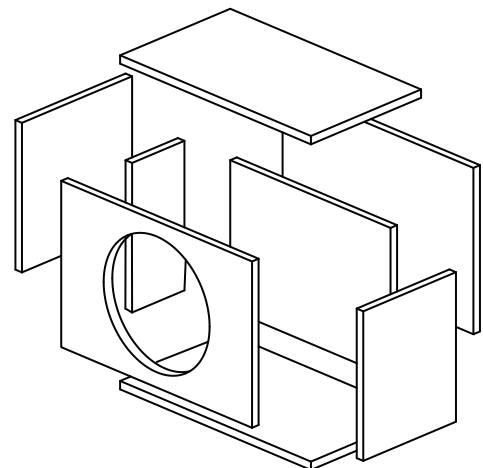
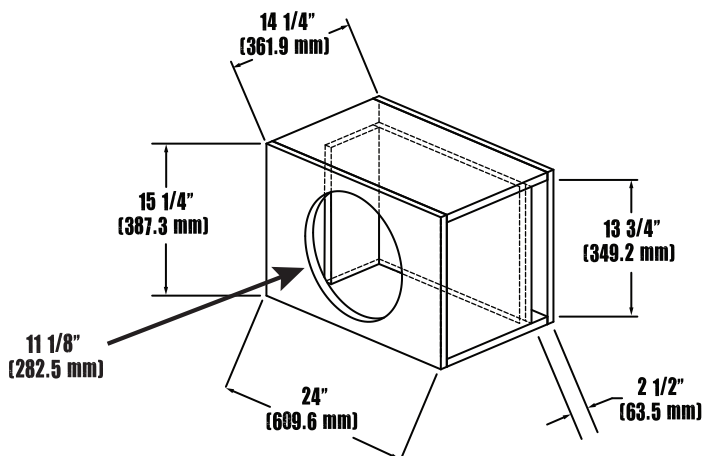

Net Internal Volume: 2.32 ft³