

Unpacking

Thank you for buying the MSI® **Z170A GAMING M3/ H170 GAMING M3/ B150 GAMING M3** [motherboard](#). Check to make sure your motherboard box contains the following items. If something is missing, contact your dealer as soon as possible.

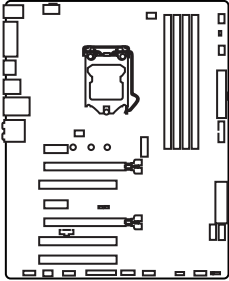

Motherboard

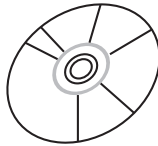

Drivers & Utilities
Disc



Motherboard User
Guide



I/O Shield

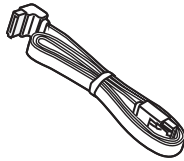

SATA Cable

The MSI logo, consisting of the lowercase letters "msi" in a bold, italicized, blue sans-serif font.

Safety Information

- The components included in this package are prone to damage from electrostatic discharge (ESD). Please adhere to the following instructions to ensure successful computer assembly.
- Ensure that all components are securely connected. Loose connections may cause the computer to not recognize a component or fail to start.
- Hold the motherboard by the edges to avoid touching sensitive components.
- It is recommended to wear an electrostatic discharge (ESD) wrist strap when handling the motherboard to prevent electrostatic damage. If an ESD wrist strap is not available, discharge yourself of static electricity by touching another metal object before handling the motherboard.
- Store the motherboard in an electrostatic shielding container or on an anti-static pad whenever the motherboard is not installed.
- Before turning on the computer, ensure that there are no loose screws or metal components on the motherboard or anywhere within the computer case.
- Do not boot the computer before installation is completed. This could cause permanent damage to the components as well as injury to the user.
- If you need help during any installation step, please consult a certified computer technician.
- Always turn off the power supply and unplug the power cord from the power outlet before installing or removing any computer component.
- Keep this user guide for future reference.
- Keep this motherboard away from humidity.
- Make sure that your electrical outlet provides the same voltage as is indicated on the PSU, before connecting the PSU to the electrical outlet.
- Place the power cord such a way that people can not step on it. Do not place anything over the power cord.
- All cautions and warnings on the motherboard should be noted.
- If any of the following situations arises, get the motherboard checked by service personnel:
 - Liquid has penetrated into the computer.
 - The motherboard has been exposed to moisture.
 - The motherboard does not work well or you can not get it work according to user guide.
 - The motherboard has been dropped and damaged.
 - The motherboard has obvious sign of breakage.
- Do not leave this motherboard in an environment above 60°C (140°F), it may damage the motherboard.

Quick Start

Preparing Tools and Components

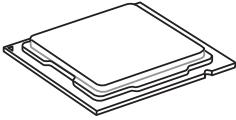

Intel® LGA 1151 CPU

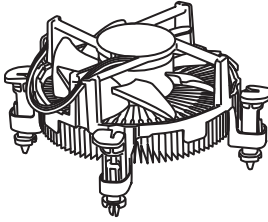

CPU Fan

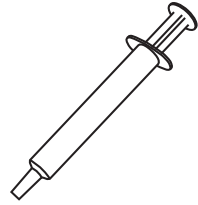

Thermal Paste

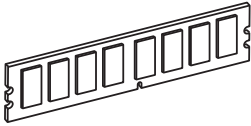

DDR4 Memory

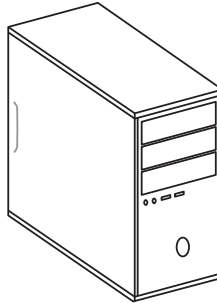

Chassis

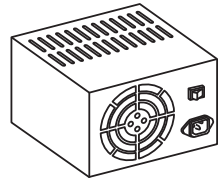

Power Supply Unit



SATA DVD Drive

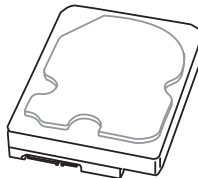

SATA Hard Disk Drive

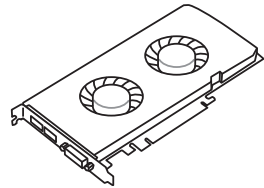

Graphics Card

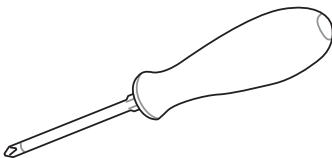

Phillips Screwdriver

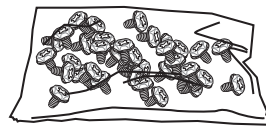

A Package of Screws

Installing a Processor

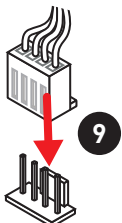
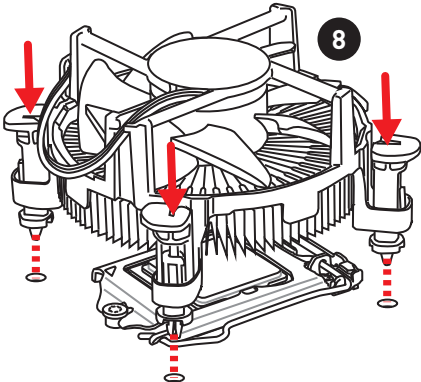
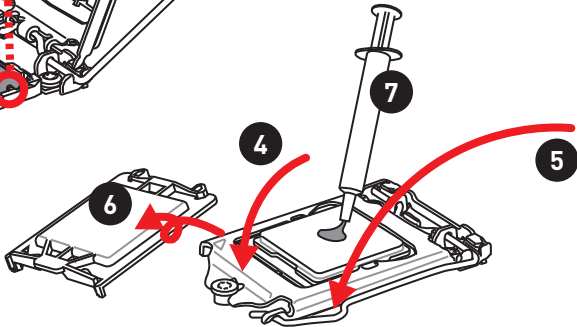
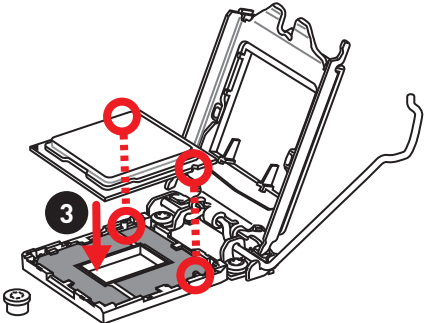
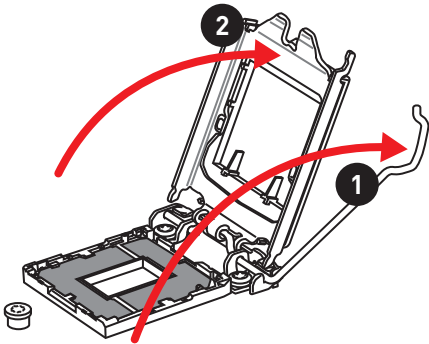

Installing DDR4 memory

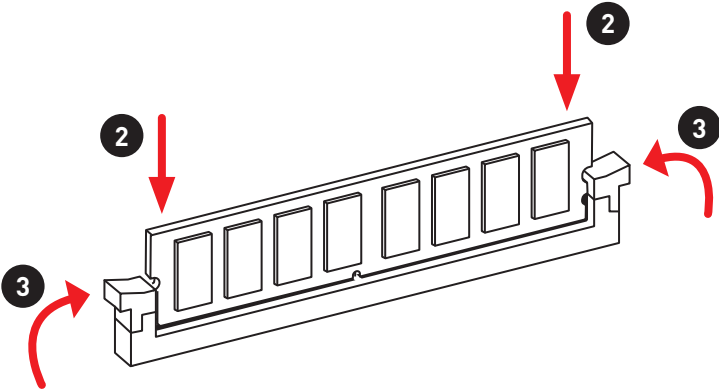
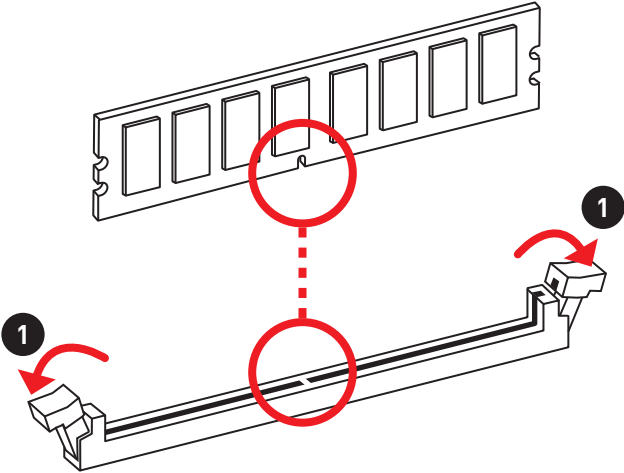

Connecting the Front Panel Header

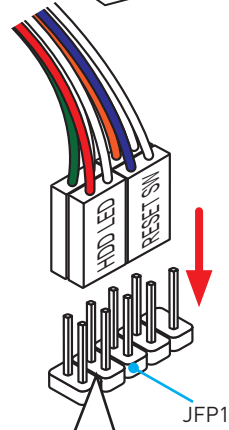
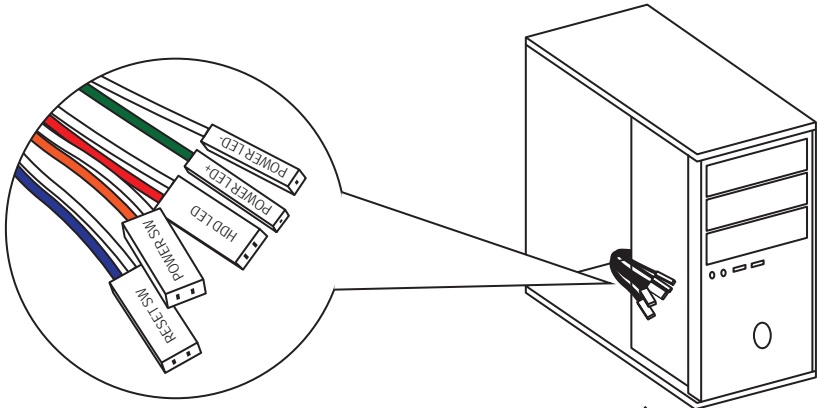

<p>JFP1</p>		1	HDD LED +	2	Power LED +
		3	HDD LED -	4	Power LED -
		5	Reset Switch	6	Power Switch
		7	Reset Switch	8	Power Switch
		9	Reserved	10	No Pin

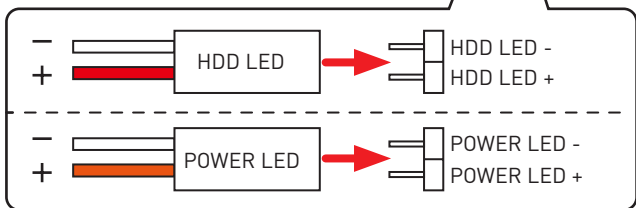

Installing the Motherboard

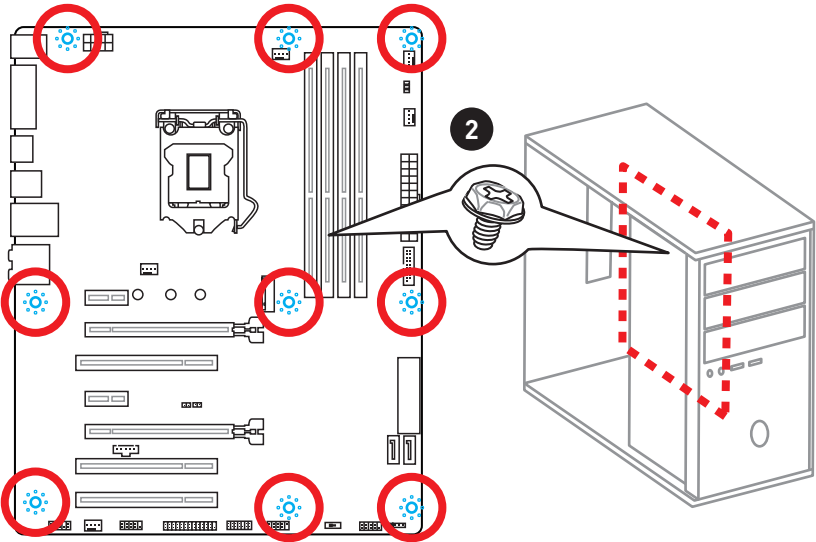
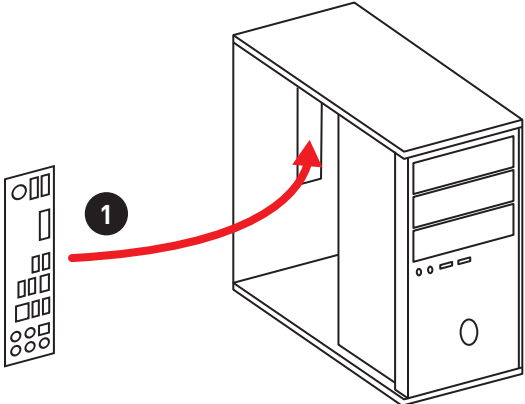

Installing SATA Drives

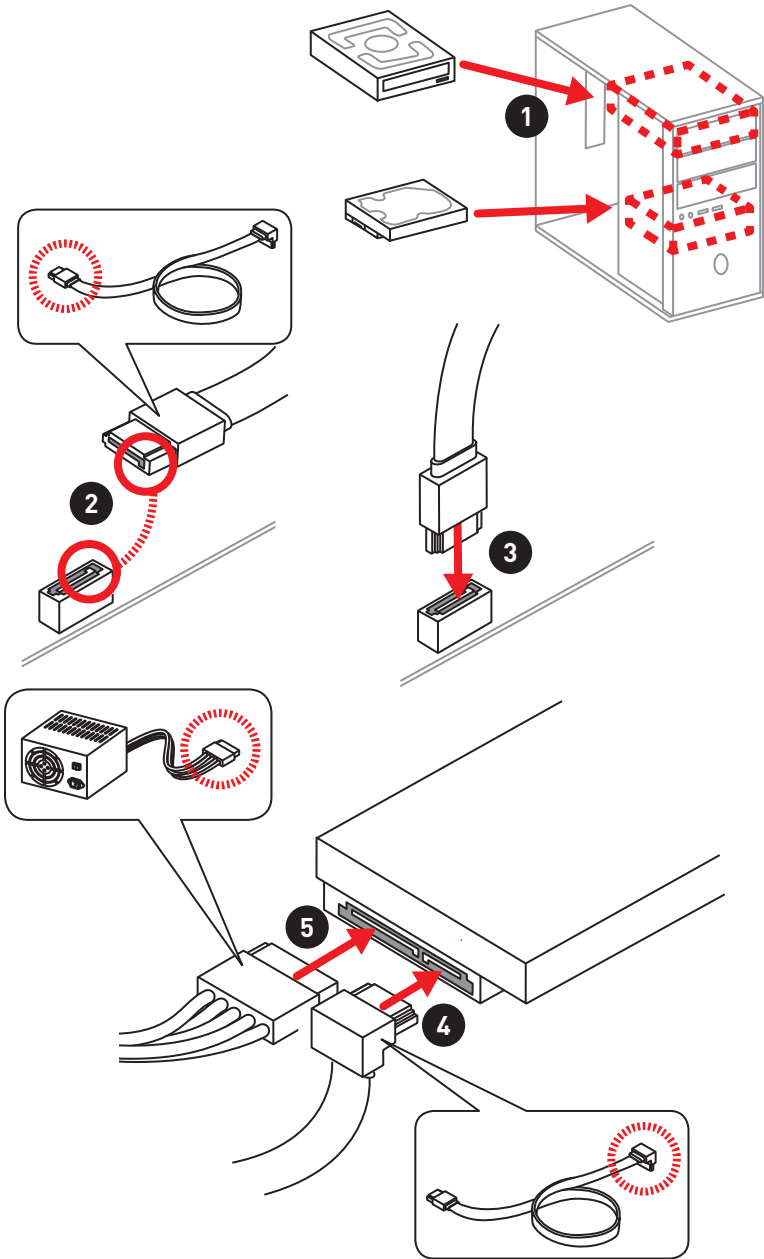

Installing a Graphics Card

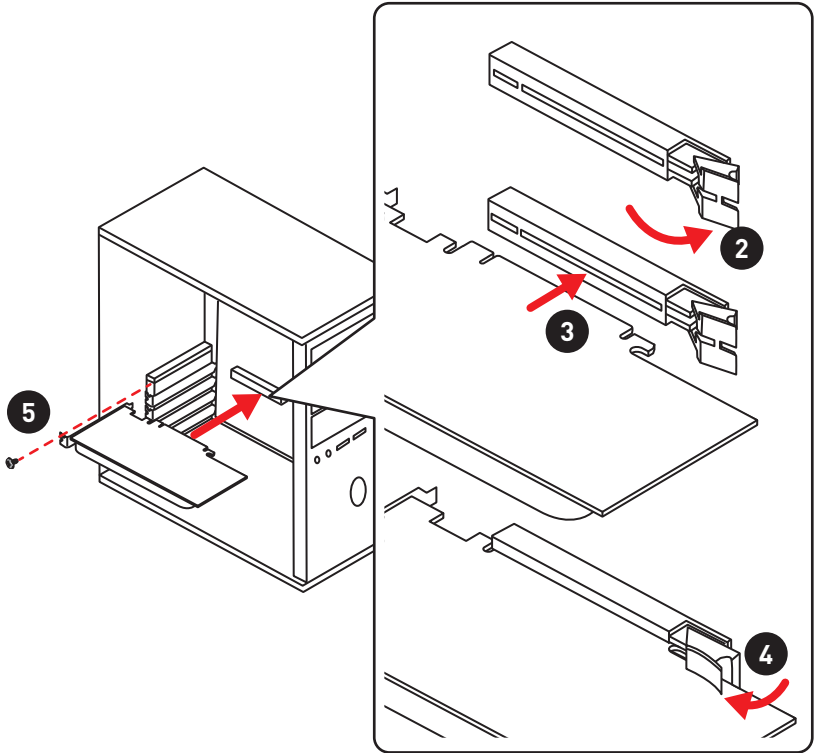
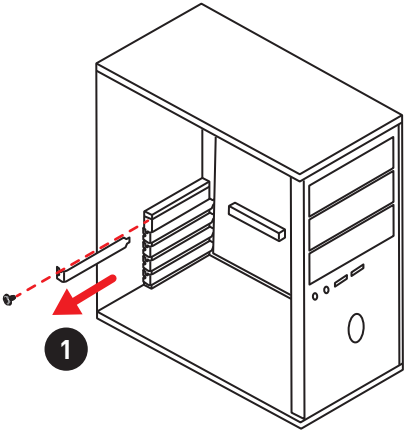

Connecting Peripheral Devices

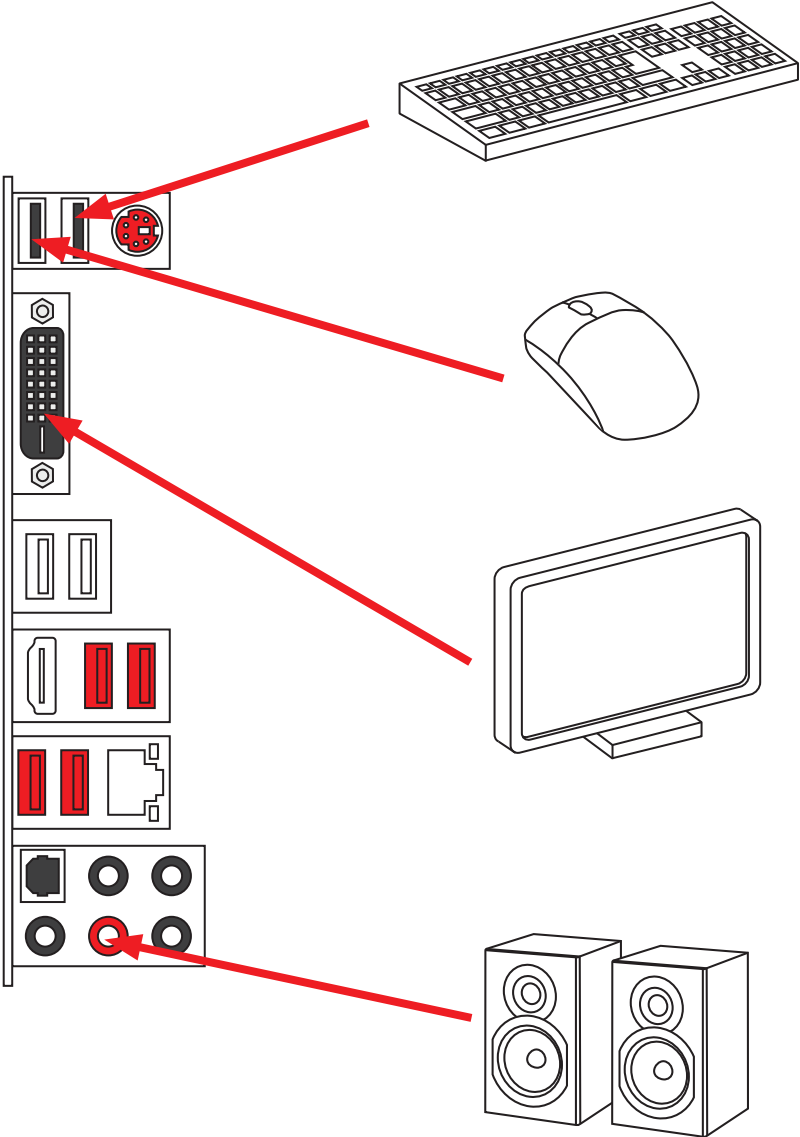

Connecting the Power Connectors

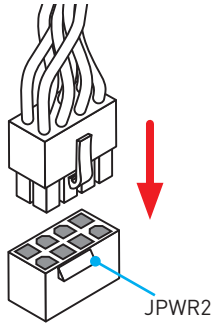
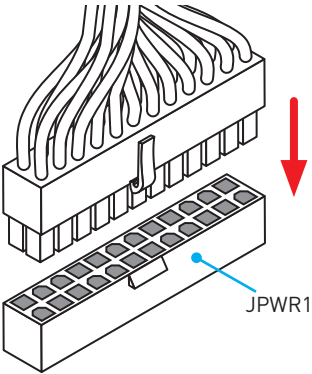
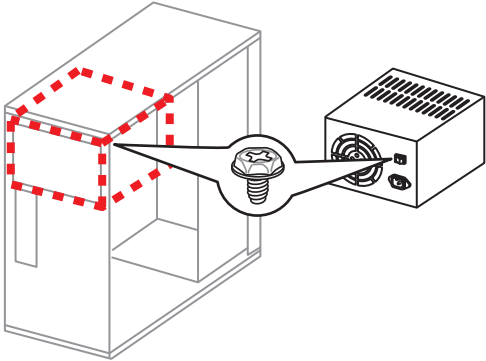

Power On

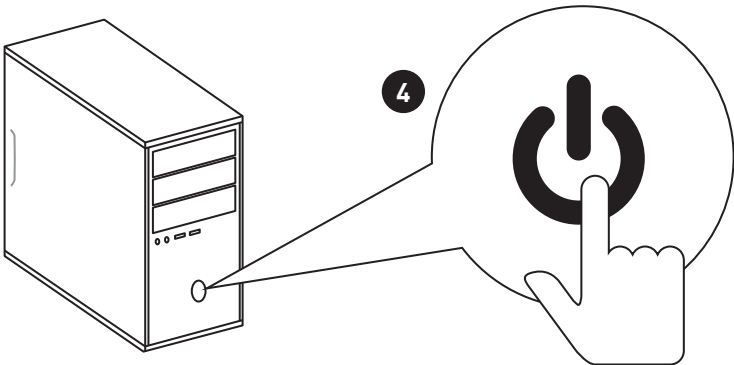
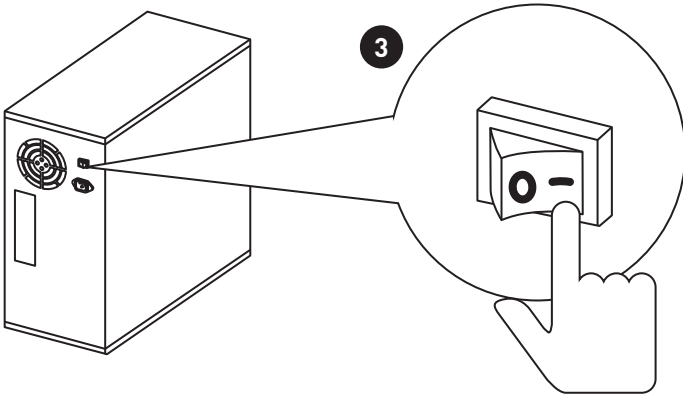
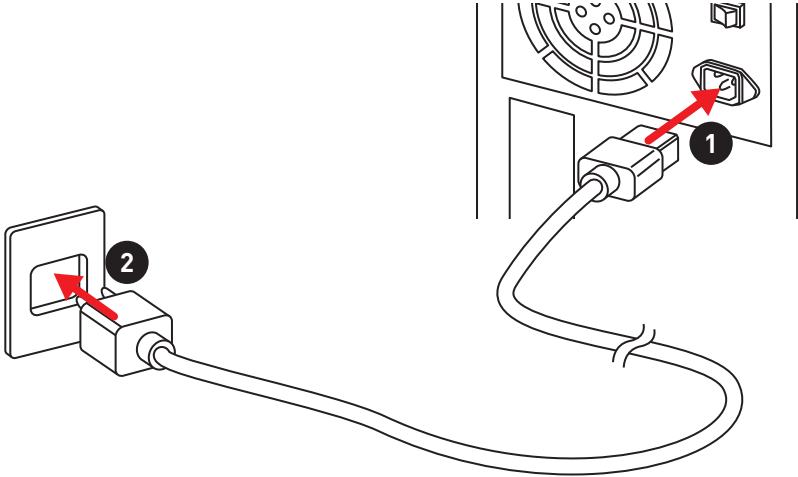

Specifications

CPU	Supports 6th Gen Intel® Core™ i3/i5/i7 processors, and Intel® Pentium® and Celeron® processors for Socket LGA1151
Chipset	Intel® Z170/ H170/ B150 Chipset (optional)
Memory	<ul style="list-style-type: none"> • 4x DDR4 memory slots, support up to 64GB <ul style="list-style-type: none"> ▪ Supports DDR4 3600(OC)/ 3200(OC)/ 3000(OC)/2800(OC)/ 2600(OC)/ 2400(OC)/ 2133 MHz* • Dual channel memory architecture • Supports ECC, un-buffered memory • Supports Intel® Extreme Memory Profile (XMP) <ul style="list-style-type: none"> * Only Z170A GAMING M3 supports overclocking (OC) frequency.
Expansion Slots	<ul style="list-style-type: none"> • 2x PCIe 3.0 x16 slots* • 2x PCIe 3.0 x1 slots • 3x PCI slots <p>* The PCI_E4 slot will only run PCIe 3.0 x1 speed when the PCI_E1 or PCI_E3 slot is installed a device.</p>
Onboard Graphics	<ul style="list-style-type: none"> • 1x HDMI™ port, supports a maximum resolution of 4096x2160@24Hz, 2560x1600@60Hz • 1x DVI-D port, supports a maximum resolution of 1920x1200@60Hz
Multi-GPU	<ul style="list-style-type: none"> • Supports 2-Way AMD® CrossFire™ Technology
Storage	<p>Intel® Z170/ H170/ B150 Chipset</p> <ul style="list-style-type: none"> • 6x SATA 6Gb/s ports • 1x M.2 slots <ul style="list-style-type: none"> ▪ Supports PCIe 3.0 x4 (optional) and SATA 6Gb/s standards, 4.2cm/ 6cm/ 8cm length M.2 SSD cards ▪ Supports PCIe 3.0 x4 NVMe Mini-SAS SSD with Turbo U.2 Host Card (optional)* • 2x or 1x SATAe port (optional)** • Supports RAID 0, RAID1, RAID 5 and RAID 10 (optional) • Supports Intel® Smart Response Technology for Intel Core™ processors. (optional) <p>* The Turbo U.2 Host Card is not included, please purchase separately. ** SATAe port is backward compatible with SATA.</p>

Continued on next page

Continued from previous page

USB	<ul style="list-style-type: none">• Intel® Z170/ H170/ B150 Chipset<ul style="list-style-type: none">▪ 2x USB 3.1 Gen2 (SuperSpeed USB 10Gbps) ports on the back panel (optional)▪ 6x USB 3.1 Gen1 (SuperSpeed USB) ports (4 ports on the back panel, 2 ports available through the internal USB connector)▪ 4x or 6x USB 2.0 (High-speed USB) ports (2 or 4 ports on the back panel, 2 ports available through the internal USB connectors) (optional)
Audio	<ul style="list-style-type: none">• Realtek® ALC1150 Codec• 7.1-Channel High Definition Audio• Supports S/PDIF output
LAN	1x Killer™ E2400 Gigabit LAN controller
Back Panel Connectors	<ul style="list-style-type: none">• 1x PS/2 keyboard/ mouse port• 2x or 4x USB 2.0 ports (optional)• 1x DVI-D port• 1x HDMI™ port• 2x USB 3.1 Gen2 ports (optional)• 4x USB 3.1 Gen1 ports• 1x LAN (RJ45) port• 1x Optical S/PDIF OUT connector• 5x OFC audio jacks

Continued on next page

Continued from previous page

Internal Connectors	<ul style="list-style-type: none">• 1x 24-pin ATX main power connector• 1x 8-pin ATX 12V power connector• 6x SATA 6Gb/s connectors• 2x or 1x SATAe connectors (optional)• 1x USB 2.0 connector (supports additional 2 USB 2.0 ports)• 1x USB 3.1 Gen1 connector (supports additional 2 USB 3.1 Gen1 ports)• 2x 4-pin CPU fan connectors• 3x 4-pin system fan connectors• 1x Front panel audio connector• 2x Front panel connectors• 1x TPM module connector• 1x Chassis Intrusion connector• 1x Clear CMOS jumper• 1x Serial port connector• 1x Parallel port connector• 1x Slow mode switch (optional)
I/O Controller	NUVOTON 6793D Controller Chip
Hardware Monitor	<ul style="list-style-type: none">• CPU/System temperature detection• CPU/System fan speed detection• CPU/System fan speed control
Form Factor	<ul style="list-style-type: none">• ATX Form Factor• 12 in. x 9.6 in. (30.4 cm x 24.4 cm)
BIOS Features	<ul style="list-style-type: none">• 1x 128 Mb flash• UEFI AMI BIOS• ACPI 5.0, PnP 1.0a, SM BIOS 2.8• Multi-language

Continued on next page

Continued from previous page

Software	<ul style="list-style-type: none">• Drivers• COMMAND CENTER• LIVE UPDATE 6• FAST BOOT• SUPER CHARGER• GAMING APP• M-CLOUD• RAMDISK• Intel® Small Business Advantage (optional)• Killer Network Manager• Nahimic Audio• Open Broadcaster Software• Intel® Extreme Tuning Utility• Norton™ Security• Google Chrome™ ,Google Toolbar, Google Drive• SteelSeries Engine 3• CPU-Z
----------	--

Continued on next page

Continued from previous page

<p>Enthusiast GAMING features</p>	<ul style="list-style-type: none">• AUDIO BOOST 3<ul style="list-style-type: none">▪ Isolated Audio PCB▪ EMI Shielding▪ Dual Headphone Amplifiers▪ High Quality Audio Capacitors▪ Golden Audio Connectors• GAME BOOST<ul style="list-style-type: none">▪ Easy Overclocking• GAMING LAN<ul style="list-style-type: none">▪ Killer E2400 Gigabit Ethernet▪ Killer Network Manager▪ EMI Shielding▪ Electric Wave Surge• GAMING APP<ul style="list-style-type: none">▪ System Mode Switching: OC/Gaming/Silent▪ Gaming Hotkey▪ Gaming Mouse Control• Nahimic<ul style="list-style-type: none">▪ Sound Effect Equalizer▪ Microphone Noise Reduction▪ HD Audio Recorder• GAMING CERTIFIED
-----------------------------------	---

Continued on next page

Continued from previous page

MSI Exclusive Features	<ul style="list-style-type: none">• CLICK BIOS 5<ul style="list-style-type: none">▪ EZ Mode & Advanced Mode Switching▪ Board Explorer▪ Hardware Monitor• MILITARY CLASS 5<ul style="list-style-type: none">▪ Military Class Component▪ Military Class Stability and Reliability<ul style="list-style-type: none">• ESD Protection• EMI Protection• Humidity Protection• Circuit Protection• High Temperature Protection• VGA Armor PCIe Slots• COMMAND CENTER<ul style="list-style-type: none">▪ System Monitor▪ Smart Fan Control• RAM DISK• LIVE UPDATE 6• M-CLOUD• CPU-Z• EZ Debug LED
Specification Highlights	<ul style="list-style-type: none">• DDR4 Boost Support<ul style="list-style-type: none">▪ Dual-Channel DDR4 Memory Support▪ Isolated DDR4 Circuit Design▪ DDR4 XMP Ready• PCI Express 3.0 Support<ul style="list-style-type: none">▪ 2-Way AMD CrossFire™ Support• USB 3.1 Gen2 Ready<ul style="list-style-type: none">▪ USB 3.1 Gen2 Type-A Ready• Turbo M.2 Ready<ul style="list-style-type: none">▪ PCIe 3.0 x4 (32 Gb/s) Support▪ PCIe / SATA Dual Mode Support (optional)• SATA Express Support• NVMe / AHCI Driver Support• U.2 Support (Optional)

Specification Comparison Table

	Z170A GAMING M3	H170 GAMING M3	B150 GAMING M3
Chipset	Z170	H170	B150
Supports DDR4 Frequency (MHz)	3600(OC), 3200(OC), 3000(OC), 2800(OC), 2600(OC), 2400(OC), 2133	2133	2133
Supports M.2 Interface	PCIe, SATA	PCIe, SATA	SATA
Supports U.2 Card	Yes	Yes	No
SATAe ports	2	1	1
Supports RAID 0,1,5,10	Yes	Yes	No
M.2, SATA and SATAe ports maximum support	1x M.2 SSD + 2xSATAe HDDs + 2xSATA HDDs	1x M.2 SSD + 1xSATAe HDD + 4xSATA HDDs	1x M.2 SSD + 1xSATAe HDD + 4xSATA HDDs
Supports Intel® Smart Response Technology	Yes	Yes	No
USB 3.1 Gen2 ports on the back panel	2	0	0
USB 2.0 ports on the rear back panel	4	6	6
Supports Intel® Small Business Advantage	No	Yes	Yes
Slow mode switch	With	Without	Without

Block Diagram

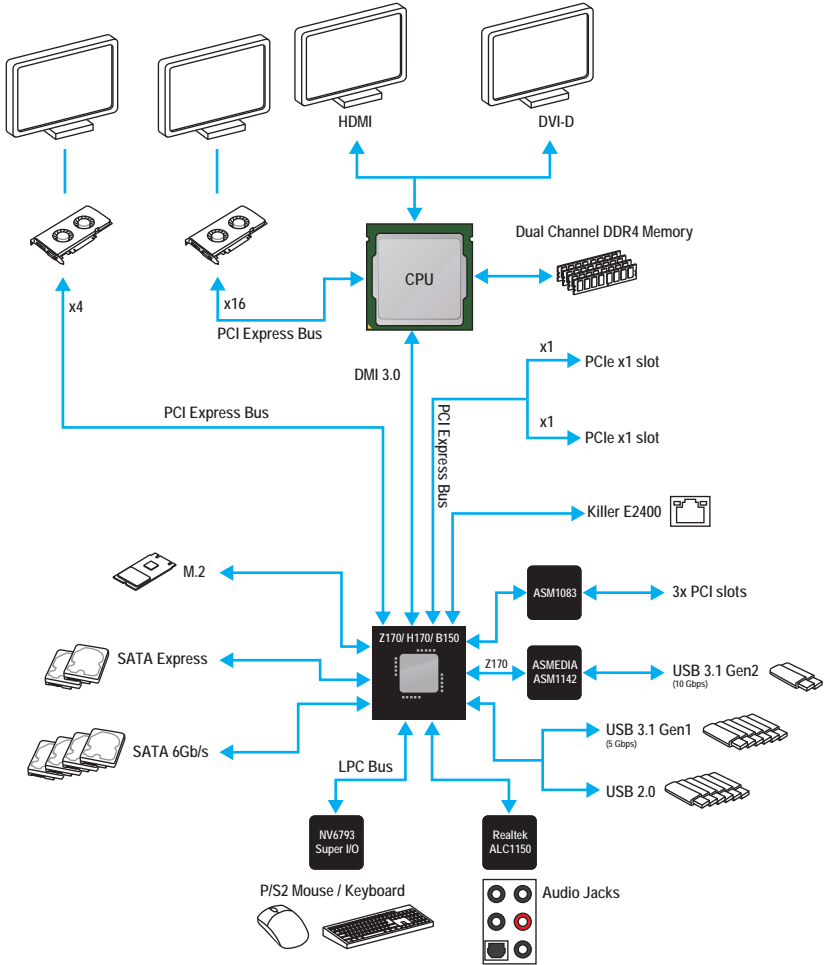

Rear I/O Panel

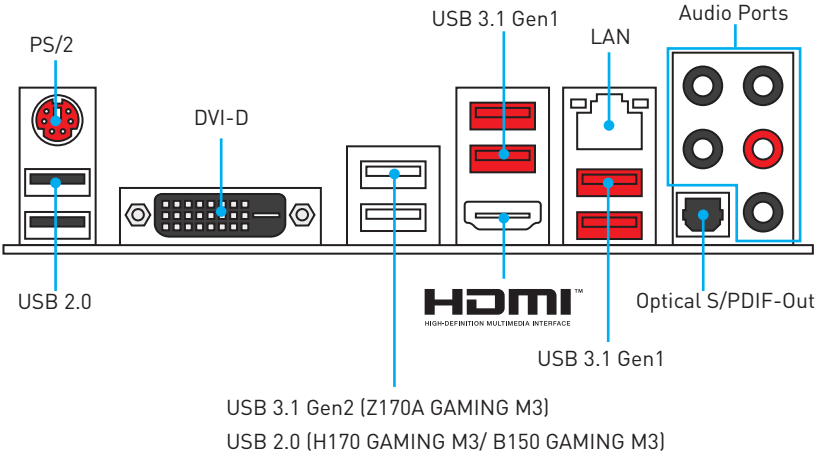

LAN Port LED Status Table

Link/ Activity LED	
Status	Description
Off	No link
Yellow	Linked
Blinking	Data activity

Speed LED	
Status	Description
Off	10 Mbps connection
Green	100 Mbps connection
Orange	1 Gbps connection

Audio Ports Configuration

Audio Ports	Channel			
	2	4	6	8
Center/ Subwoofer Out			●	●
Rear Speaker Out		●	●	●
Line-In/ Side Speaker Out				●
Line-Out/ Front Speaker Out	●	●	●	●
Mic In				

(●: connected, **Blank**: empty)

Realtek HD Audio Manager

After installing the **Realtek HD Audio** driver, the **Realtek HD Audio Manager** icon will appear in the system tray. Double click on this icon to launch.



- **Device Selection** - allows you to select a audio output source to change the related options. The **check** sign indicates the devices as default.
- **Application Enhancement** - the array of options will provide you a complete guidance of anticipated sound effect for both output and input device.
- **Main Volume** - controls the volume or balance the right/left side of the speakers that you plugged in front or rear panel by adjust the bar.
- **Profiles** - toggles between profiles.
- **Advanced Settings** - provides the mechanism to deal with 2 independent audio streams.
- **Jack Status** - depicts all render and capture devices currently connected with your computer.
- **Connector Settings** - configures the connection settings.

Auto popup dialog

When you plug into a device at an audio jack, a dialogue window will pop up asking you which device is current connected.

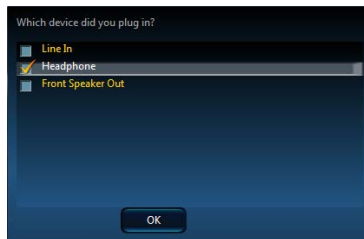

Each jack corresponds to its default setting as shown on the next page.

Audio jacks to headphone and microphone diagram

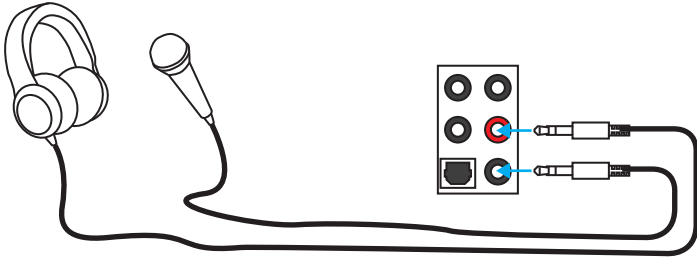

Audio jacks to stereo speakers diagram

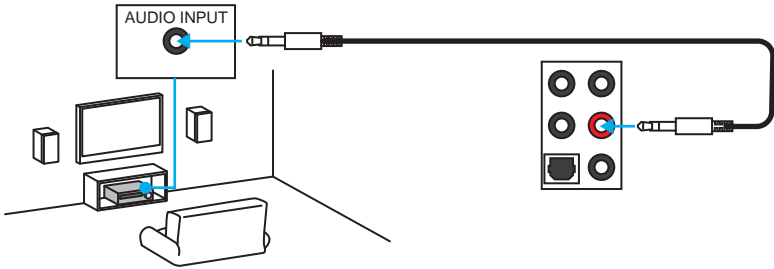

Audio jacks to 7.1-channel speakers diagram

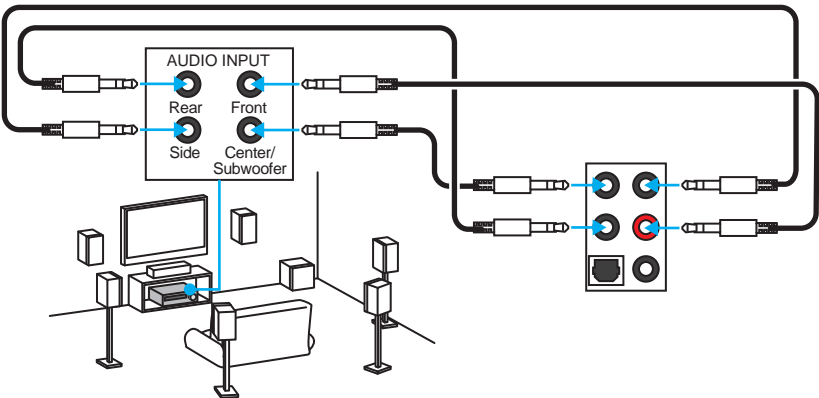

Overview of Components

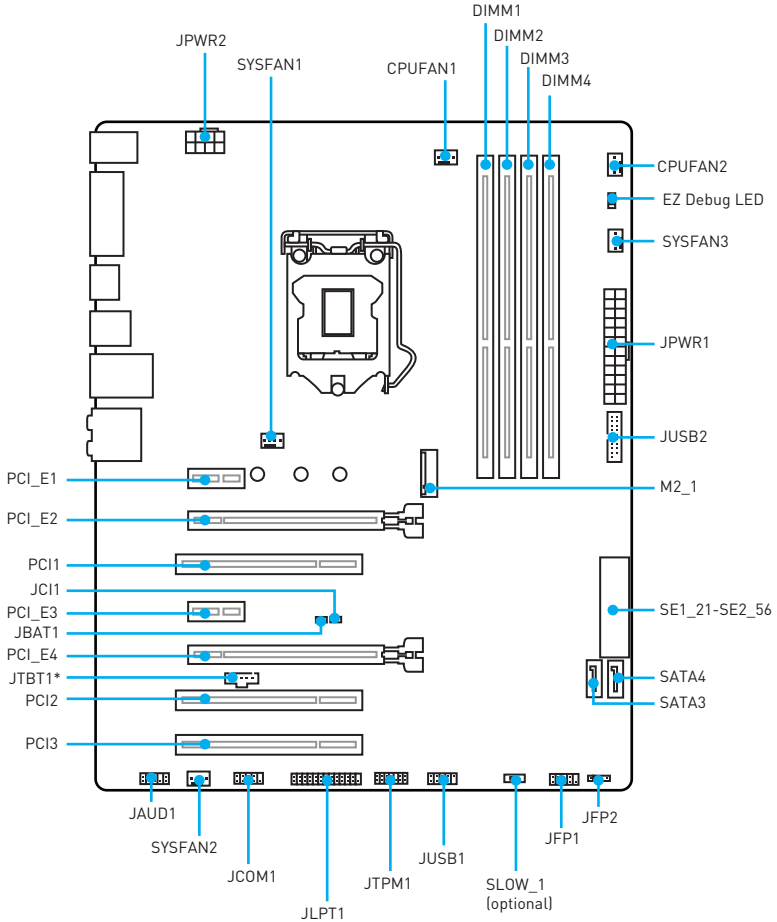

*JTBT1 is used to connect a specific card.

Note: The JTBT1 connector and the PCI_E4 slot can't be used simultaneously.

Component Contents

Port Name	Port Type	Page
CPUFAN1~2, SYSFAN1~3	Fan Connectors	37
CPU Socket	LGA1151 CPU Socket	28
DIMM1~4	DIMM Slots	29
EZ Debug LED	Debug LED indicators	40
JAUD1	Front Audio Connector	34
JBAT1	Clear CMOS (Reset BIOS) Jumper	39
JCI1	Chassis Intrusion Connector	38
JCOM1	Serial Port Connector	36
JFP1, JFP2	Front Panel Connectors	38
JLPT1	Parallel Port Connector	36
JPWR1~2	Power Connectors	34
JTPM1	TPM Module Connector	36
JUSB1	USB 2.0 Connector	35
JUSB2	USB 3.1 Gen1 Connector	35
M2_1	M.2 Slot	32
PCI_E1~4, PCI1~3	PCIe and PCI Expansion Slots	30
SATA1~6	SATA 6Gb/s Connectors	31
SE1_21-SE2_65	SATAe Connectors	31
SLOW_1	Slow Mode Booting Switch	39

CPU Socket

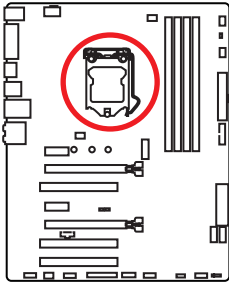

Introduction to the LGA 1151 CPU

The surface of the LGA 1151 CPU has two **notches** and a **golden triangle** to assist in correctly lining up the CPU for motherboard placement. The golden triangle is the Pin 1 indicator.

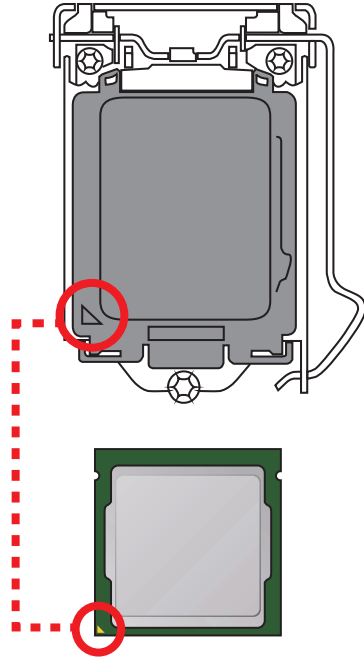

Important

- Always unplug the power cord from the power outlet before installing or removing the CPU.
- Please retain the CPU protective cap after installing the processor. MSI will deal with Return Merchandise Authorization (RMA) requests if only the motherboard comes with the protective cap on the CPU socket.
- When installing a CPU, always remember to install a CPU heatsink. A CPU heatsink is necessary to prevent overheating and maintain system stability.
- Confirm that the CPU heatsink has formed a tight seal with the CPU before booting your system.
- Overheating can seriously damage the CPU and motherboard. Always make sure the cooling fans work properly to protect the CPU from overheating. Be sure to apply an even layer of thermal paste (or thermal tape) between the CPU and the heatsink to enhance heat dissipation.
- Whenever the CPU is not installed, always protect the CPU socket pins by covering the socket with the plastic cap.
- If you purchased a separate CPU and heatsink/ cooler, Please refer to the documentation in the heatsink/ cooler package for more details about installation.
- This motherboard is designed to support overclocking. Before attempting to overclock, please make sure that all other system components can tolerate overclocking. Any attempt to operate beyond product specifications is not recommended. MSI® does not guarantee the damages or risks caused by inadequate operation beyond product specifications.

DIMM Slots

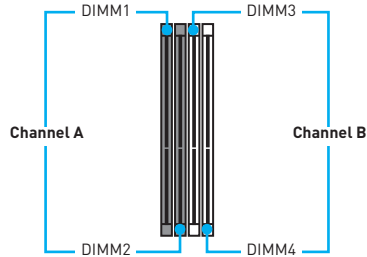
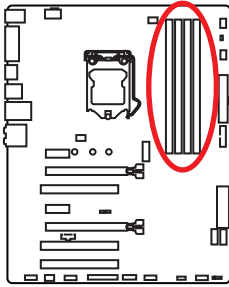

Memory module installation recommendation

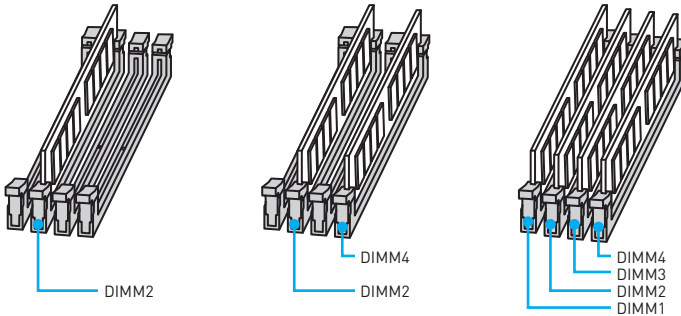

Important

- Always insert memory modules in the **DIMM2** slot first.
- Due to chipset resource usage, the available capacity of memory will be a little less than the amount of installed.
- Based on Intel CPU specification, the Memory DIMM voltage below 1.35V is suggested to protect the CPU.
- Please note that the maximum capacity of addressable memory is 4GB or less for 32-bit Windows OS due to the memory address limitation. Therefore, we recommended that you to install 64-bit Windows OS if you want to install more than 4GB memory on the motherboard.
- Some memory may operate at a lower frequency than the marked value when overclocking due to the memory frequency operates dependent on its Serial Presence Detect (SPD). Go to BIOS and find the **Memory Try It!** to set the memory frequency if you want to operate the memory at the marked or at a higher frequency.
- It is recommended to use a more efficient memory cooling system for full DIMMs installation or overclocking.
- The stability and compatibility of installed memory module depend on installed CPU and devices when overclocking.

PCI_E1~4, PCI1~3: PCIe and PCI Expansion Slots

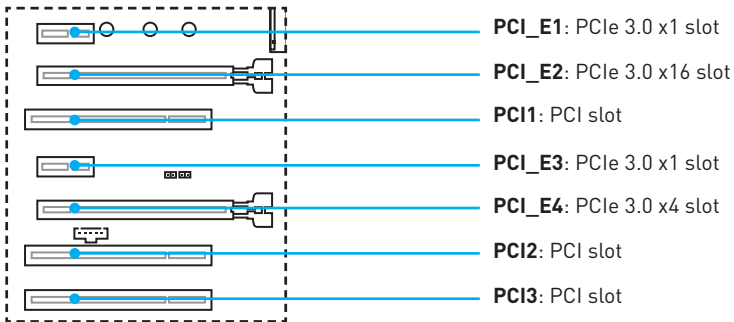

Multiple graphics cards installation recommendation

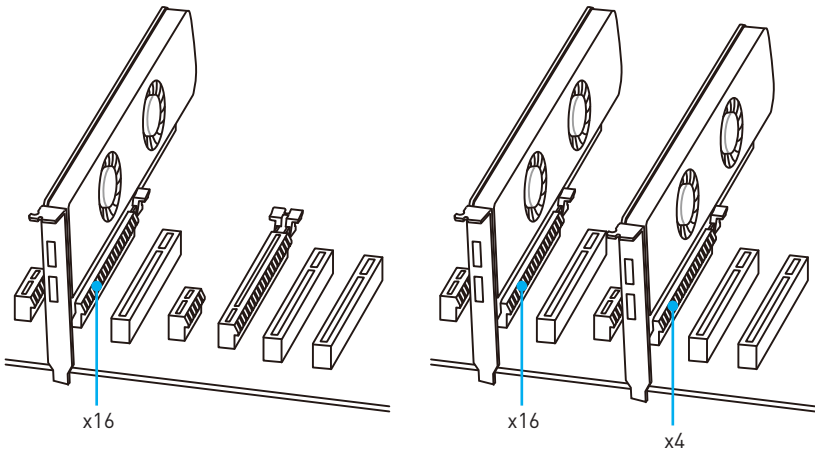

Important

- For a single PCIe x16 expansion card installation with optimum performance, using the **PCI_E2** slot is recommended.
- The **PCI_E4** slot will only run PCIe 3.0 x1 speed when the **PCI_E1** or **PCI_E3** slot is installed a device.
- When adding or removing expansion cards, always turn off the power supply and unplug the power supply power cable from the power outlet. Read the expansion card's documentation to check for any necessary additional hardware or software changes.

SATA1~6: SATA 6Gb/s Connectors

These connectors are SATA 6Gb/s interface ports. Each connector can connect to one SATA device.

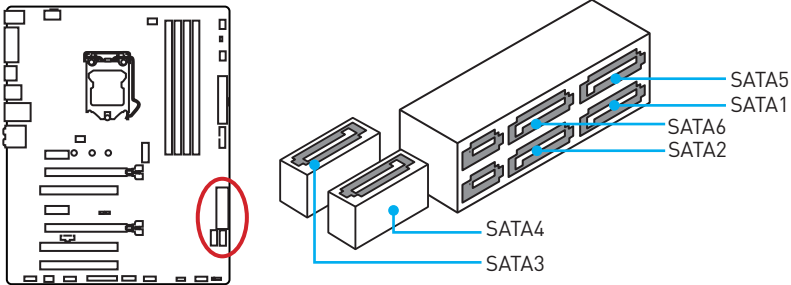

SE1_21-SE2_65: SATAe Connectors

These connectors are SATAe (SATA Express) interface ports. Each SATAe connector can be used with a single SATAe device or two legacy SATA devices.

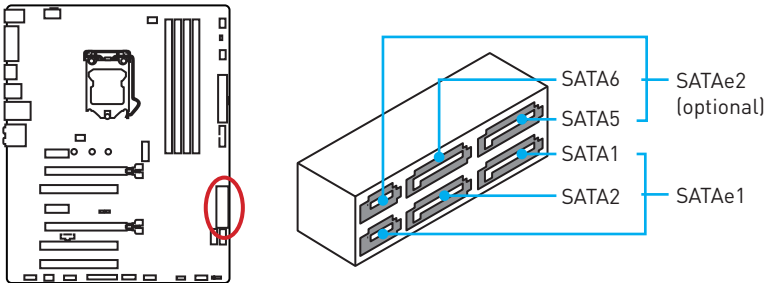

Important

- Please do not fold the SATA or SATAe cable at a 90-degree angle. Data loss may result during transmission otherwise.
- SATA cables have identical plugs on either sides of the cable. However, it is recommended that the flat connector be connected to the motherboard for space saving purposes.

M2_1: M.2 Slot

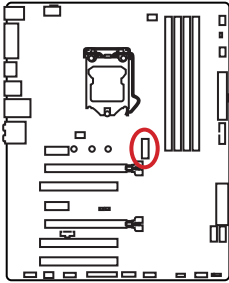

Important

Intel® RST only supports PCIe M.2 SSD with UEFI ROM, does not support Legacy ROM.

Installing M.2 module

1. Remove the screw from the base screw.
2. Remove the base screw.

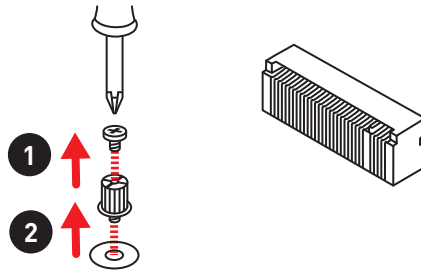

3. Tighten the base screw into the hole of the distance to the M.2 slot as the length your M.2 module.
4. Insert your M.2 module into the M.2 slot at a 30-degree angle.

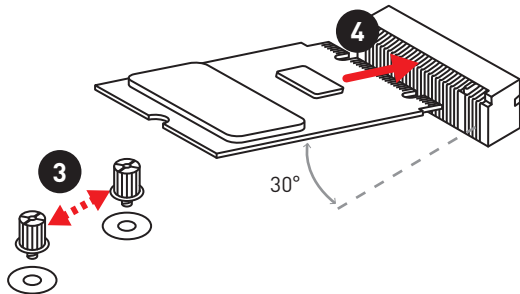

5. Put the screw in the notch on the trailing edge of your M.2 module and tighten it into the base screw.

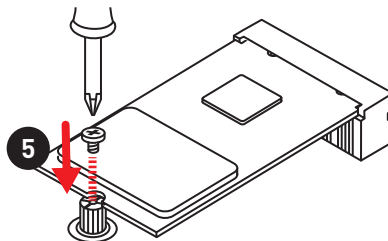

M.2/ SATA & SATAe combination table

Slot	Available SATA/ SATAe connectors		
M2_1	Empty	SATA	PCIe
SATA_EX1	✓	✓	✓
SATA_EX2 (optional)	✓	✓	✓
SATA1	✓	—	✓
SATA2	✓	—	✓
SATA3	✓	✓	—
SATA4	✓	✓	—
SATA5	✓	✓	✓
SATA6	✓	✓	✓

[**SATA**: M.2 SATA SSD, **PCIe**: M.2 PCIe SSD, ✓: available, —: unavailable]

M.2 slots with examples of various combination possibilities

1xM.2 SATA SSD + 1xSATAe HDD + 4xSATA HDDs

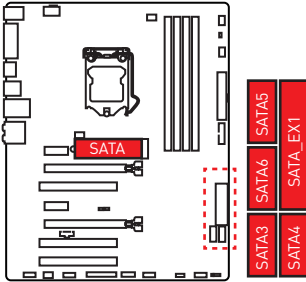

1xM.2 SATA SSD + 2xSATAe HDDs + 2xSATA HDDs

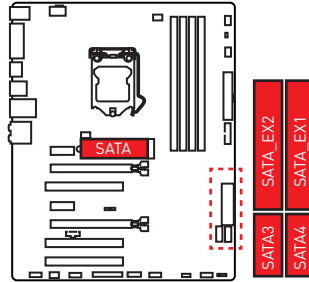

1xM.2 PCIe SSD + 4xSATA HDDs

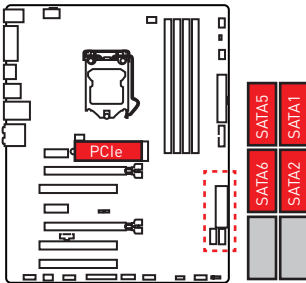

1xM.2 PCIe SSD + 2xSATAe HDDs

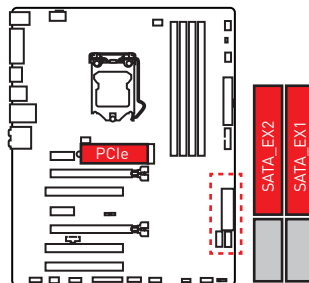

JPWR1~2: Power Connectors

These connectors allow you to connect an ATX power supply.

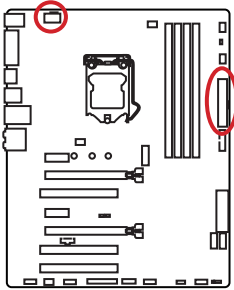

1	Ground	5	+12V
2	Ground	6	+12V
3	Ground	7	+12V
4	Ground	8	+12V

1	+3.3V	13	+3.3V
2	+3.3V	14	-12V
3	Ground	15	Ground
4	+5V	16	PS-ON#
5	Ground	17	Ground
6	+5V	18	Ground
7	Ground	19	Ground
8	PWR OK	20	Res
9	5VSB	21	+5V
10	+12V	22	+5V
11	+12V	23	+5V
12	+3.3V	24	Ground

Important

Make sure that all the power cables are securely connected to a proper ATX power supply to ensure stable operation of the motherboard.

JAUD1: Front Audio Connector

This connector allow you to connect audio jacks on the front panel.

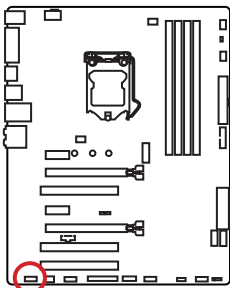

1	MIC L	2	Ground
3	MIC R	4	NC
5	Head Phone R	6	MIC Detection
7	SENSE_SEND	8	No Pin
9	Head Phone L	10	Head Phone Detection

JUSB1: USB 2.0 Connector

This connector allows you to connect USB 2.0 ports on the front panel.

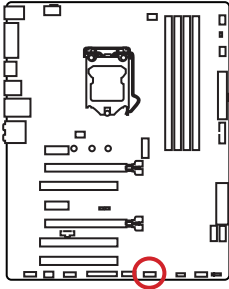

1	VCC	2	VCC
3	USB0-	4	USB1-
5	USB0+	6	USB1+
7	Ground	8	Ground
9	No Pin	10	NC

Important

- Note that the VCC and Ground pins must be connected correctly to avoid possible damage.
- In order to recharge your iPad, iPhone and iPod through USB ports, please install MSI® SUPER CHARGER utility.

JUSB2: USB 3.1 Gen1 Connector

This connector allows you to connect USB 3.1 Gen1 ports on the front panel.

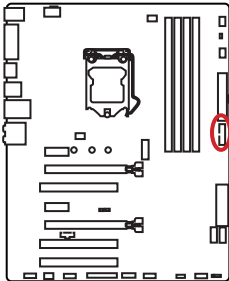

1	Power	11	USB2.0+
2	USB3_RX_DN	12	USB2.0-
3	USB3_RX_DP	13	Ground
4	Ground	14	USB3_TX_C_DP
5	USB3_TX_C_DN	15	USB3_TX_C_DN
6	USB3_TX_C_DP	16	Ground
7	Ground	17	USB3_RX_DP
8	USB2.0-	18	USB3_RX_DN
9	USB2.0+	19	Power
10	Ground	20	No Pin

Important

Note that the Power and Ground pins must be connected correctly to avoid possible damage.

JTPM1: TPM Module Connector

This connector is for TPM (Trusted Platform Module). Please refer to the TPM security platform manual for more details and usages.

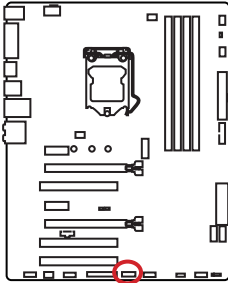

1	LPC Clock	2	3V Standby power
3	LPC Reset	4	3.3V Power
5	LPC address & data pin0	6	Serial IRQ
7	LPC address & data pin1	8	5V Power
9	LPC address & data pin2	10	No Pin
11	LPC address & data pin3	12	Ground
13	LPC Frame	14	Ground

JCOM1: Serial Port Connector

This connector allows you to connect the optional serial port with bracket.

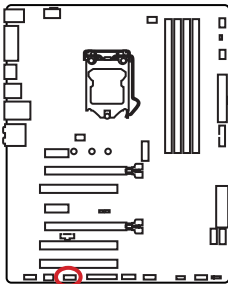

1	DCD	2	SIN
3	SOUT	4	DTR
5	Ground	6	DSR
7	RTS	8	CTS
9	RI	10	No Pin

JLPT1: Parallel Port Connector

This connector allows you to connect the optional parallel port with bracket.

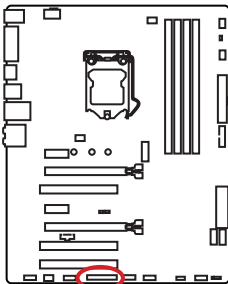



1	RSTB#	2	AFD#	3	PRND0
4	ERR#	5	PRND1	6	PINIT#
7	PRND2	8	LPT_SLIN#	9	PRND3
10	Ground	11	PRND4	12	Ground
13	PRND5	14	Ground	15	PRND6
16	Ground	17	PRND7	18	Ground
19	ACK#	20	Ground	21	BUSY
22	Ground	23	PE	24	Ground
25	SLCT	26	No Pin		

CPUFAN1~2, SYSFAN1~3: Fan Connectors

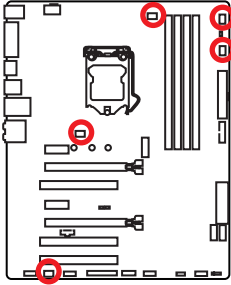

Fan connectors can be classified as PWM (Pulse Width Modulation) Mode and Voltage Mode. PWM Mode fan connectors provide constant 12V output and adjust fan speed with speed control signal. Voltage Mode fan connectors control fan speed by changing voltage. Therefore, when you plug a 3-pin (Non-PWM) fan to a PWM Mode fan connector, the fan speed will be always maintained at 100%, and that could be noisy.



PWM Mode fan connector

 1 CPUFAN1		 1 CPUFAN2	
1	Ground	2	+12V
3	Sense	4	Speed Control Signal

Voltage Mode fan connector

 1 SYSFAN1/ SYSFAN2		 1 SYSFAN3	
1	Ground	2	Voltage Control
3	Sense	4	NC

Controlling the fan speed

There are two ways to manage fan speed. One is to go to **BIOS > HARDWARE MONITOR**. The other is to use **COMMAND CENTER** application.

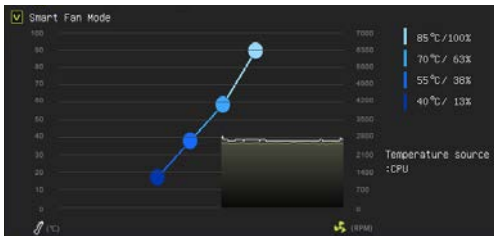

BIOS > HARDWARE MONITOR



COMMAND CENTER

Both methods offer gradient points of the fan speed that allow you to adjust fan speed in relation to CPU temperature.

JFP1, JFP2: Front Panel Connectors

These connectors connect to the switches and LEDs on the front panel.

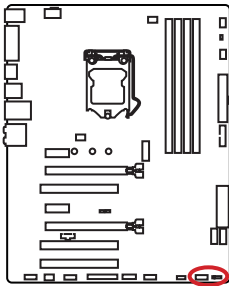

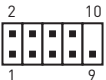
 JFP1			
1	HDD LED +	2	Power LED +
3	HDD LED -	4	Power LED -
5	Reset Switch	6	Power Switch
7	Reset Switch	8	Power Switch
9	Reserved	10	No Pin

 JFP2			
1	Speaker -	2	Buzzer +
3	Buzzer -	4	Speaker +

JCI1: Chassis Intrusion Connector

This connector allows you to connect the chassis intrusion switch cable.

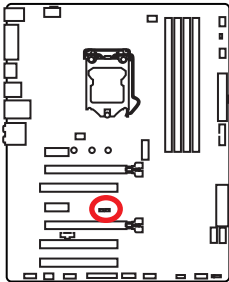

Normal
(default)



Trigger the chassis
intrusion event

Using chassis intrusion detector

1. Connect the **JCI1** connector to the chassis intrusion switch/ sensor on the chassis.
2. Close the chassis cover.
3. Go to **BIOS > Settings > Security > Chassis Intrusion Configuration**.
4. Set **Chassis Intrusion** to **Enabled**.
5. Press **F10** to save and exit and then press the **Enter** key to select **Yes**.
6. Once the chassis cover is opened again, a warning message will be displayed on screen when the computer is turned on.

Resetting the chassis intrusion warning

1. Go to **BIOS > Settings > Security > Chassis Intrusion Configuration**.
2. Set **Chassis Intrusion** to **Reset**.
3. Press **F10** to save and exit and then press the **Enter** key to select **Yes**.

JBAT1: Clear CMOS (Reset BIOS) Jumper

There is CMOS memory onboard that is external powered from a battery located on the motherboard to save system configuration data. If you want to clear the system configuration, set the jumpers to clear the CMOS memory.

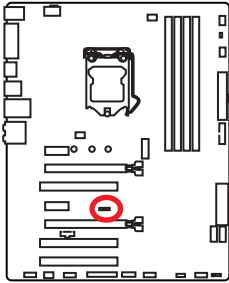

Keep Data
(default)



Clear CMOS/
Reset BIOS

Resetting BIOS to default values

1. Power off the computer and unplug the power cord
2. Use a jumper cap to short JBAT1 for about 5-10 seconds.
3. Remove the jumper cap from JBAT1.
4. Plug the power cord and power on the computer.

SLOW_1: Slow Mode Booting Switch (optional)

This switch is used for LN2 cooling solution, that provides the extreme overclocking conditions, to boot at a stable processor frequency and to prevent the system from crashing.

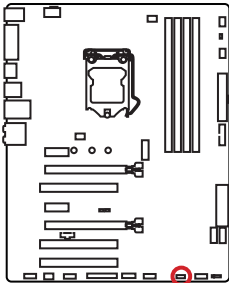

Normal
(Default)



Enabled



Important

Users will try extreme low temperature overclocking at their own risks. The overclocking results will vary according to the CPU version.

EZ Debug LED: Debug LED indicators

These LEDs indicate the status of the motherboard.

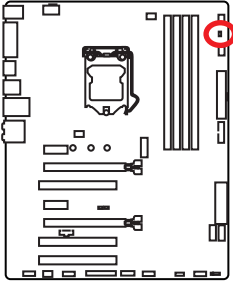

- VGA** - indicates GPU is not detected or fail.
- DRAM** - indicates DRAM is not detected or fail.
- CPU** - indicates CPU is not detected or fail.

BIOS Setup

The default settings offer the optimal performance for system stability in normal conditions. You should **always keep the default settings** to avoid possible system damage or failure booting unless you are familiar with BIOS.

Important

- BIOS items are continuously update for better system performance. Therefore, the description may be slightly different from the latest BIOS and should be for reference only. You could also refer to the **HELP** information panel for BIOS item description.
- The pictures in this chapter are for reference only and may vary from the product you purchased.

Entering BIOS Setup

Please refer the following methods to enter BIOS setup.

- Press **Delete** key, when the **Press DEL key to enter Setup Menu, F11 to enter Boot Menu** message appears on the screen during the boot process.
- Use **MSI FAST BOOT** application. Click on **G02BIOS** button and choose **OK**. The system will reboot and enter BIOS setup directly.



Click on **G02BIOS**

- Enable the **G02BIOS** item (**SETTING > Boot > G02BIOS**) in BIOS setup **Advanced mode** (F7). It allows the system to enter BIOS setup directly by pressing the power button for 4 seconds upon bootup.

Function key

Key	Function	Key	Function
F1	General Help	F3	Enter Favorites menu
F4	Enter CPU Specifications menu	F5	Enter Memory-Z menu
F6	Load optimized defaults	F8	Load Overclocking Profile
F9	Save Overclocking Profile	F10	Save Change and Reset*

* When you press F10, a confirmation window appears and it provides the modification information. Select between **Yes** or **No** to confirm your choice.

Resetting BIOS

You might need to restore the default BIOS setting to solve certain problems. There are several ways to reset BIOS:

- Go to BIOS and press **F6** to load optimized defaults.
- Short the **Clear CMOS** jumper on the motherboard.
- Press the **Clear CMOS** button, on the rear I/O panel. (Only for the motherboard with clear CMOS button.)

Updating BIOS

Updating BIOS with M-FLASH

Before updating:

Please download the latest BIOS file that matches your motherboard model from MSI website. And then save the BIOS file into the USB flash drive.

Updating BIOS:

1. Press Del key to enter the BIOS Setup during POST.
2. Insert the USB flash drive that contains the update file into the computer.
3. Select the **M-FLASH** tab and click on **Yes** to reboot the system and enter the flash mode.
4. Select a BIOS file to perform the BIOS update process.
5. After the flashing process is 100% completed, the system will reboot automatically.

Updating the BIOS with Live Update 6

Before updating:

Make sure the LAN driver is already installed and the internet connection is set properly.

Updating BIOS:

1. Install and launch MSI LIVE UPDATE 6.
2. Select **Manual scan**.
3. Check **MB BIOS** box and click on **Scan** button.
4. Select the **MB BIOS** and click on  icon to download and install the latest BIOS file.
5. Click **Next** and choose **In Windows mode**. And then click **Next** and **Start** to start updating BIOS.
6. After the flashing process is 100% completed, the system will restart automatically.

EZ Mode

At EZ mode, it provides the basic system information and allows you to configure the basic setting. To configure the advanced BIOS settings, please enter the Advanced Mode by pressing the **Setup Mode switch** or **F7** function key.

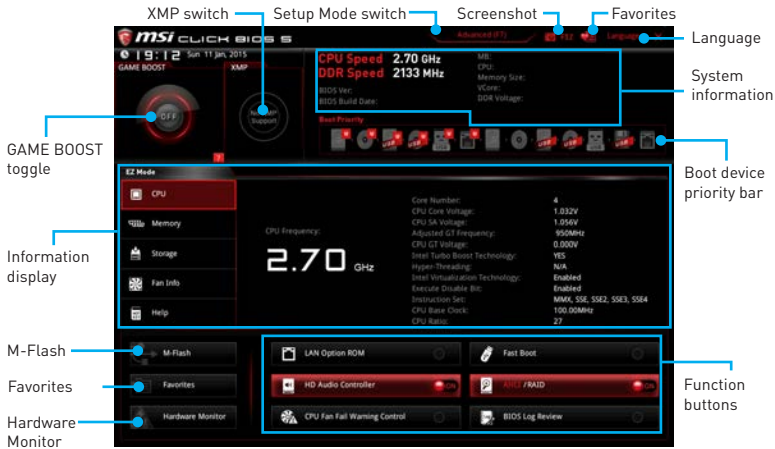

- **Function buttons** - enable or disable the **LAN Option ROM**, **Fast Boot**, **HD audio controller**, **AHCI**, **RAID**, **CPU Fan Fail Warning Control** and **BIOS Log Review** by clicking on their respective button.
- **Hardware Monitor** - click on this button to display the **Hardware Monitor** menu that allows you to manually control the fan speed by percentage.
- **M-Flash** - click on this button to display the **M-Flash** menu that provides the way to update BIOS with a USB flash drive.
- **Information display** - click on the **CPU**, **Memory**, **Storage**, **Fan Info** and **Help** buttons on left side to display related information.
- **Boot device priority bar** - you can move the device icons to change the boot priority. The boot priority from high to low is left to right.
- **System information** - shows the CPU/ DDR speed, CPU/ MB temperature, MB/ CPU type, memory size, CPU/ DDR voltage, BIOS version and build date.
- **Language** - allows you to select the language of BIOS setup.
- **Screenshot** - press this tab or the **F12** key to take a screenshot and save it to USB flash drive (FAT/ FAT32 format only).
- **Setup Mode switch** - press this tab or the **F7** key to switch between Advanced mode and EZ mode.
- **XMP switch** - click on the inner circle to enable/ disable the X.M.P. (Extreme Memory Profile). Switch the outer circle to select the X.M.P. profile. This switch will only be available if the X.M.P. supported memory module is installed.

- **GAME BOOST toggle** - click on it to toggle the GAME BOOST for OC.



Important

Please don't make any changes in OC menu and don't load defaults to keep the optimal performance and system stability after activating the GAME BOOST function.

- **Favorites** - press any **Favorites** tab or the **F3** key to enter **Favorites** menu. It allows you to create personal BIOS menu where you can save and access favorite/frequently-used BIOS setting items.
 - **Default HomePage** - allows you to select a BIOS menu (e.g. SETTINGS, OC...,etc) as the BIOS home page.
 - **Favorite1~5** - allows you to add the frequently-used/ favorite BIOS setting items in one page.
 - **To add a BIOS item to a favorite page (Favorite 1~5)**
 1. Select a BIOS item in SETTINGS or OC menu.
 2. Right-click or press **F2** key.
 3. Choose a favorite page and click on **OK**.
 - **To delete a BIOS item from favorite page**
 1. Select a BIOS item in favorite page (Favorite 1~5)
 2. Right-click or press **F2** key.
 3. Choose **Delete** and click on **OK**.

Advanced Mode

Press **Setup Mode switch** or **F7** function key can switch between EZ Mode and Advanced Mode in BIOS setup.

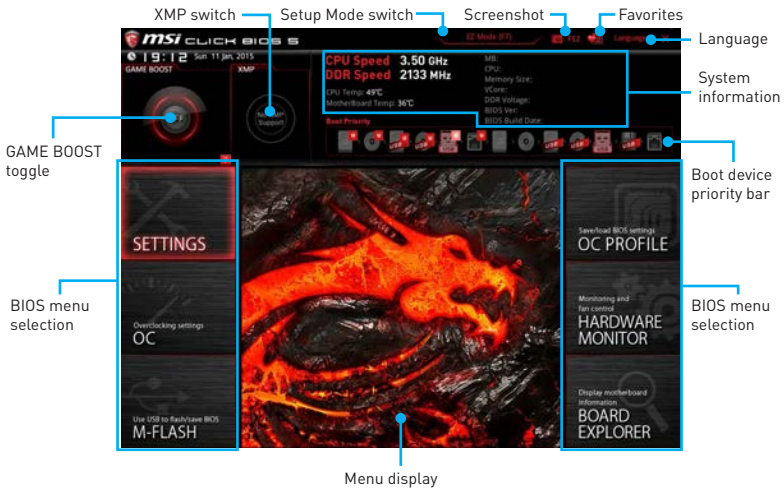

- **GAME BOOST toggle/ XMP switch/ Setup Mode switch/ Screenshot/ Favorites/ Language/ System information/ Boot device priority bar** - please refer to the descriptions of EZ Mode Overview section.
- **BIOS menu selection** - the following options are available:
 - **SETTINGS** - allows you to specify the parameters for chipset and boot devices.
 - **OC** - allows you to adjust the frequency and voltage. Increasing the frequency may get better performance.
 - **M-FLASH** - provides the way to update BIOS with a USB flash drive.
 - **OC PROFILE** - allows you to manage overclocking profiles.
 - **HARDWARE MONITOR** - allows you to set the speeds of fans and monitor voltages of system.
 - **BOARD EXPLORER** - provides the information of installed devices on this motherboard.
- **Menu display** - provides BIOS setting items and information to be configured.

SETTINGS



System Status

► System Date

Sets the system date. Use tab key to switch between date elements.

The format is <day> <month> <date> <year>.

<day> Day of the week, from Sun to Sat, determined by BIOS. Read-only.

<month> The month from Jan. through Dec.

<date> The date from 1 to 31 can be keyed by numeric function keys.

<year> The year can be adjusted by users.

► System Time

Sets the system time. Use tab key to switch between time elements.

The time format is <hour> <minute> <second>.

► SATA PortX

Shows the information of connected SATA device.

Important

If the connected SATA device is not displayed, turn off computer and re-check SATA cable and power cable connections of the device and motherboard.

► System Information

Shows detailed system information, including CPU type, BIOS version, and Memory (read only).

► DMI Information

Shows system information, desktop Board Information and chassis Information. (Read only).

Advanced

► PCI Subsystem Settings

Sets PCI, PCI express interface protocol and latency timer. Press <Enter> to enter the sub-menu.

▶ **PEG X - Max Link Speed [Auto]**

Sets PCI Express protocol of PCIe x16 slots for matching different installed devices.

[Auto] This item will be configured automatically by BIOS.

[Gen1] Enables PCIe Gen1 support only.

[Gen2] Enables PCIe Gen2 support only.

[Gen3] Enables PCIe Gen3 support only.

▶ **PCI Latency Timer [32]**

Sets latency timer of PCI interface device.

[Options: 32, 64, 96, 128, 160, 192, 224, 248 PCI Bus clocks]

▶ **ACPI Settings**

Sets ACPI parameters of onboard power LED behaviors. Press <Enter> to enter the sub-menu.

▶ **Power LED [Blinking]**

Sets shining behaviors of the onboard Power LED.

[Dual Color] The power LED turns to another color to indicate the S3 state.

[Blinking] The power LED blinks to indicate the S3 state.

▶ **Integrated Peripherals**

Sets integrated peripherals' parameters, such as LAN, HDD, USB and audio. Press <Enter> to enter the sub-menu.

▶ **Onboard LAN Controller [Enabled]**

Enables or disables the onboard LAN controller.

▶ **LAN Option ROM [Disabled]**

Enables or disables the legacy network Boot Option ROM for detailed settings. This item will appear when **Onboard LAN Controller** is enabled.

[Enabled] Enables the onboard LAN Boot ROM.

[Disabled] Disables the onboard LAN Boot ROM.

▶ **Network Stack [Disabled]**

Sets UEFI network stack for optimizing IPv4 / IPv6 function.

[Enabled] Enables UEFI network stack.

[Disabled] Disables UEFI network stack.

▶ **Ipv4 PXE Support [Enabled]**

When “Enabled”, the system UEFI network stack will support Ipv4 protocol. This item will appear when “Network Stack” is enabled.

[Enabled] Enables the Ipv4 PXE boot support.

[Disabled] Disables the Ipv4 PXE boot support.

▶ **Ipv6 PXE Support [Enabled]**

When “Enabled”, the system UEFI network stack will support Ipv6 protocol. This item will appear when “Network Stack” is enabled.

[Enabled] Enables the Ipv6 PXE boot support.

[Disabled] Disables the Ipv6 PXE boot support.

▶ **SATA Mode [AHCI Mode]**

Sets the operation mode of the onboard SATA controller.

[AHCI Mode] Specify the AHCI mode for SATA storage devices. AHCI (Advanced Host Controller Interface) offers some advanced features to enhance the speed and performance of SATA storage device, such as Native Command Queuing (NCQ) and hot-plugging.

[RAID Mode] Enables RAID function for SATA storage devices. (only for H170)

▶ **SATAx Hot Plug [Disabled]**

Allows user to enable or disable the SATA hot plug support.

[Enabled] Enables hot plug support for the SATA ports.

[Disabled] Disables hot plug support for the SATA ports.

▶ **HD Audio Controller [Enabled]**

Enables or disables the onboard High Definition Audio controller.

▶ **HPET [Enabled]**

Enables or disables the HPET (High Precision Event Timers) support.

▶ **Integrated Graphics Configuration**

Adjusts integrated graphics settings for optimum system. Press <Enter> to enter the sub-menu.

▶ **Initiate Graphic Adapter [PEG]**

Selects a graphics device as the primary boot device.

[IGD] Integrated Graphics Display.

[PEG] PCI-Express Graphics Device.

▶ **Integrated Graphics Share Memory [64M]**

Selects a fixed amount of system memory allocated to the onboard graphics. This item will appear when **IGD Multi-Monitor** is enabled.

▶ **IGD Multi-Monitor [Disabled]**

Enables or disables the multi-screen output from integrated graphics and external graphics card.

[Enabled] Enables multi-screen function for both integrated and external graphics cards.

[Disabled] Disables this function.

▶ **USB Configuration**

Sets the onboard USB controller and device function. Press <Enter> to enter the sub-menu.

▶ **USB Controller [Enabled]**

Enables or disables all USB controller.

▶ **XHCI Hand-off [Enabled]**

Enables or disables XHCI hand-off support for the operating system without XHCI hand-off feature. This item will appear when **USB Controller** is enabled.

▶ **Legacy USB Support [Enabled]**

Sets Legacy USB function support.

[Auto] The system will automatically detect if any USB device is connected and enable the legacy USB support.

[Enabled] Enable the USB support under legacy mode.

[Disabled] The USB devices will be unavailable under legacy mode.

▶ **Super IO Configuration**

Sets system Super I/O chip parameters including LPT and COM ports. Press <Enter> to enter the sub-menu.

▶ **Serial (COM) Port x Configuration**

Sets detailed configuration of serial(COM) port x. Press <Enter> to enter the sub-menu.

▶ **Serial (COM) Port x [Enabled]**

Enables or disables serial (COM) port x.

▶ **Serial (COM) Port x Settings [Auto]**

Sets serial port x (COM). If set to Auto, BIOS will optimize the IRQ automatically or you can set it manually.

▶ **Parallel (LPT) Port Configuration**

Sets detailed configuration of parallel port (LPT). Press <Enter> to enter the sub-menu.

▶ **Parallel (LPT) Port [Enabled]**

Enables or disables parallel(LPT) port.

▶ **Parallel (LPT) Port Settings [Auto]**

Sets parallel port (LPT). If set to Auto, BIOS will optimize the IRQ automatically or you can set it manually.

▶ **Device Mode [STD Printer Mode]**

Selects an operating mode for parallel port.

[STD Printer Mode] Printer port mode

[SPP] Standard Parallel Port mode

[EPP-1.9/ 1.7 + SPP] Enhanced Parallel Port-1.9/ 1.7 mode + Standard Parallel Port mode.

[ECP] Extended Capability Port mode

[ECP + EPP-1.9/ 1.7] Extended Capability Port mode + Enhanced Parallel Port-1.9/ 1.7 mode.

► Power Management Setup

Sets system Power Management of EuP2013 and AC Power Loss behaviors. Press <Enter> to enter the sub-menu.

► EuP 2013 [Disabled]

Enables or disables the system power consumption according to EuP2013 regulation.

[Enabled] Optimize the system power consumption according to EuP 2013 regulation. It will not support S4 & S5 wake up by USB, PCI and PCIe devices.

[Disabled] Disables this function.

► Restore after AC Power Loss [Power Off]

Sets the system behaviors while encountering the AC power loss.

[Power Off] Leaves the system in power off state after restoring AC power.

[Power On] Boot up the system after restoring AC power.

[Last State] Restores the system to the previous state (power on/ power off) before AC power loss.

► On board LED Control [On]

Enables or disables the actions of onboard LEDs.

[On] Enables the actions of onboard LEDs.

[Off] Disables the actions of power, reset, PCH, audio LEDs.

► Windows OS Configuration

Sets Windows 8/ 8.1 detailed configuration and behaviors. Press <Enter> to enter the sub-menu.

► Windows 8.1/ 10 WHQL Support [Disabled]

Enables the supports for Windows 8.1/ 10 or disables for other operating systems. Before enabling this item, make sure all installed devices & utilities (hardware & software) should meet the Windows 8.1/ 10 requirements.

[Enabled] The system will switch to UEFI mode to meet the Windows requirement.

[Disabled] Disables this function.

► MSI Fast Boot [Disabled]

MSI Fast Boot is the fastest way to boot the system. It will disable more devices to speed up system boot time which is faster than the boot time of **Fast Boot**.

[Enabled] Enables the MSI Fast Boot function to speed up booting time. And the following **Fast Boot** field will be disabled and fixed.

[Disabled] Disables MSI Fast Boot.

Important

When MSI Fast Boot is enabled, you can use MSI FAST BOOT application to enter BIOS setup if needed. Please refer **Entering BIOS Setup** section for details.

▶ **Fast Boot [Disabled/ windows7, Enabled/ windows 8.1/ 10]**

Enables or disables the fast boot feature for Windows 8.1/ 10. This item will only be available when **MSI Fast Boot** is disabled.

[Enabled] Enables the Fast Boot configuration to accelerate system boot time.

[Disabled] Disables the Fast Boot configuration.

▶ **Internal GOP Configuration**

Manages the onboard Graphics Output Protocol (GOP). Press <Enter> to enter the sub-menu. This sub-menu will appear when **Windows 8.1/ 10 WHQL Support** is enabled.

▶ **Secure Boot**

Sets the Windows secure boot to prevent the unauthorized accessing. Press <Enter> to enter the sub-menu. This sub-menu will appear when **Windows 8.1/ 10 WHQL Support** is enabled.

▶ **Secure Boot Support [Disabled]**

Enables or disables secure boot support.

[Enabled] Enables the secure boot function and allow you to set the secure boot settings.

[Disabled] Disables this function.

▶ **Secure Boot Mode [Standard]**

Selects the secure boot mode. This item is to select how the secure boot keys be loaded. This item appears when **Secure Boot Support** is enabled.

[Standard] The system will automatically load the secure keys from BIOS.

[Custom] Allows user to configure the secure boot settings and manually load the secure keys.

▶ **Key Management**

Manages the secure boot keys. Press <Enter> to enter the sub-menu. This sub-menu will appear when **Secure Boot Mode** sets to [Custom].

▶ **Wake Up Event Setup**

Sets system wake up behaviors for different sleep modes. Press <Enter> to enter the sub-menu.

▶ **Wake Up Event By [BIOS]**

Selects the wake up event by BIOS or operating system.

[BIOS] Activates the following items, set wake up events of these items.

[OS] The wake up events will be defined by OS.

▶ **Resume By RTC Alarm [Disabled]**

Disables or enables the system wake up by RTC Alarm.

[Enabled] Enables the system to boot up on a scheduled time/ date.

[Disabled] Disables this function.

▶ **Date (of month) Alarm/ Time (hh:mm:ss) Alarm**

Sets RTC alarm date/ Time. If Resume By RTC Alarm is set to [Enabled], the system will automatically resume (boot up) on a specified date/hour/minute/second in these fields (using the <+> and <-> to select the date & time settings).

▶ **Resume By PCI/ PCI-E Device [Disabled]**

Enables or disables the system wake up by PCI/ PCI express devices.

[Enabled] Enables the system to be awakened from the power saving modes when activity or input signal of PCI/ PCIe device is detected.

[Disabled] Disables this function.

▶ **Resume by USB Device [Disabled]**

Enables or disables the system wake up by USB devices.

[Enabled] Enables the system to be awakened from sleep state when activity of USB device is detected.

[Disabled] Disables this function.

▶ **Resume From S3/S4/S5 by PS/2 Mouse [Disabled]**

Enables or disables the system wake up by PS/2 mouse.

[Enabled] Enables the system to be awakened from S3/ S4/ S5 state when activity of PS/2 mouse is detected.

[Disabled] Disables this function.

▶ **Resume From S3/S4/S5 by PS/2 Keyboard [Disabled]**

Enables or disables the system wake up by PS/2 keyboard.

[Any Key] Enables the system to be awakened from S3/ S4/ S5 state when activity of any key on PS/2 keyboard is detected.

[Hot Key] Enables the system to be awakened from S3/ S4/ S5 state when activity of hot key on PS/2 keyboard is detected.

[Disabled] Disables this function.

▶ **Hot Key [Ctrl+Space]**

Selects a combination of keys as a hot key to wake the system. This item appears when you set the Resume From S3/S4/S5 by PS/2 Keyboard to **Hot Key**.

Boot

Sets the sequence of system boot devices.

▶ **Full Screen Logo Display [Enabled]**

Enables or disables to show the full screen logo while system POST.

[Enabled] Shows the logo in full screen.

[Disabled] Shows the POST messages.

▶ **GO2BIOS [Disabled]**

Allows system to enter BIOS setup directly by pressing the Power button for 4 sec upon bootup.

[Enabled] The system boots straight to the BIOS setup by long pressing the power button about 4 seconds when the system is off.

[Disabled] Disables this function.

▶ **Bootup NumLock State [On]**

Select the keyboard NumLock state upon bootup.

▶ **Boot Mode Select [LEGACY+UEFI]**

Sets the system boot mode from legacy or UEFI architecture depending on OS installation requirement. This item will become un-selectable and will be configured automatically by BIOS when **Windows 8.1/ 10 WHQL Support** is enabled.

[UEFI] Enables UEFI BIOS boot mode support only.

[LEGACY+UEFI] Enables both Legacy BIOS boot mode and UEFI BIOS boot mode.

▶ **FIXED BOOT ORDER Priorities**

Sets device priority for system boot.

▶ **Boot Option Priorities**

These items are used to prioritize the installed boot devices.

Security

▶ **Administrator Password**

Sets administrator password for system security. User has full rights to change the BIOS items with administrator password. After setting the administrator password, the state of this item will show “Installed”.

▶ **User Password**

Sets User Password for system security. User has limited rights to change the BIOS items with user password. This item will be available when administrator password is set. After setting the user password, the state of this item will show “Installed”.

▶ **Password Check [Setup]**

Selects a condition that will request the password.

[Setup] A password will be requested for entering the BIOS Setup.

[Boot] A password will be requested for booting the system.

▶ **Password Clear [Enabled]**

Enables or disables the clear CMOS behavior to clear a set password.

[Enabled] The password will be erased after clear CMOS.

[Disabled] The password will always be kept.

Important

When selecting the Administrator / User Password items, a password box will appear on the screen. Type the password then press <Enter>. The password typed now will replace any previous set password from CMOS memory. You will be prompted to confirm the password. You may also press <Esc> to abort the selection.

To clear a set password, press <Enter> when you are prompted to enter a new password. A message will confirm the password is being disabled. Once the password is disabled, you can enter the setup and OS without authorization.

▶ **Trusted Computing**

Sets TPM (Trusted Platform Module) function.

▶ **Security Device Support [Enabled]**

Enables or disables the TPM function to build the endorsement key for accessing the system.

▶ **TPM Device Selection [PTT]**

Selects TPM device: PTT or dTPM.

[PTT] Select it for Intel Platform Trust technology

[dTPM] Select it for installed TPM device.

▶ **Device select [Auto]**

Selects TPM 1.2 or TPM 2.0 technology for installed TPM device. If set to **Auto**, BIOS will detect it automatically.

▶ **Chassis Intrusion Configuration**

Press <Enter> to enter the sub-menu.

▶ **Chassis Intrusion [Disabled]**

Enables or disables recording messages when the chassis is opened. This function is ready for the chassis equips a chassis intrusion switch.

[Enabled] Once the chassis is opened, the system will record and issue a warning message.

[Reset] Clear the warning message. After clearing the message, please return to **Enabled** or **Disabled**.

[Disabled] Disables this function.

Save & Exit

▶ **Discard Changes and Exit**

Exit BIOS setup without saving any change.

▶ **Save Changes and Reboot**

Save all changes and reboot the system.

▶ **Save Changes**

Save current changes.

▶ **Discard Changes**

Discard all changes and restore to the previous values.

▶ **Restore Defaults**

Restore or load all default values.

▶ **Boot Override**

The installed bootable devices will appear on this menu, you can select one of them to be the boot device.



⚠ Important

- Overclocking your PC manually is only recommended for advanced users.
- Overclocking is not guaranteed, and if done improperly, it could void your warranty or severely damage your hardware.
- If you are unfamiliar with overclocking, we advise you to use GAME BOOST function for easy overclocking.

▶ **OC Explore Mode [Normal]**

Enables or disables to show the normal or expert version of OC settings.

[Normal] Provides the regular OC settings in BIOS setup.

[Expert] Provides the advanced OC settings for OC expert to configure in BIOS setup.

Note: We use * as the symbol for the OC settings of Expert mode.

▶ **CPU Ratio Apply Mode [All Core]***

Sets applied mode for CPU ratio. This item only appears when a CPU that supports **Turbo Boost** is installed.

[All Core] Activate the **CPU Ratio** field. All CPU cores will run the same CPU ratio that be set in **CPU Ratio**.

[Per Core] Activate the **X-Core Ratio Limit** field. Sets each CPU core ratio separately in **X-Core Ratio Limit**.

▶ **CPU Ratio [Auto]**

Sets the CPU ratio that is used to determine CPU clock speed. This item can only be changed if the processor supports this function.

▶ **1/2/3/4-Core Ratio Limit [Auto]***

Allows you to set the CPU ratios for different number of active cores. These items only appear when a CPU that support this function is installed.

▶ **Adjusted CPU Frequency**

Shows the adjusted CPU frequency. Read-only.

▶ **CPU Ratio Mode [Dynamic Mode]***

Selects the CPU Ratio operating mode. This item will appear when you set the CPU ratio manually.

[Fixed Mode] Fixes the CPU ratio.

[Dynamic Mode] CPU ratio will be changed dynamically according to the CPU loading.

▶ **Ring Ratio [Auto]**

Sets the ring ratio. The valid value range depends on the installed CPU.

▶ **Adjusted Ring Frequency**

Shows the adjusted Ring frequency. Read-only.

▶ **GT Ratio [Auto]**

Sets the integrated graphics ratio. The valid value range depends on the installed CPU.

▶ **Adjusted GT Frequency**

Shows the adjusted integrated graphics frequency. Read-only.

▶ **Misc Setting***

Press Enter, + or - key to open or close the following 3 items related to CPU features.

▶ **EIST [Enabled]***

Enables or disables the Enhanced Intel® SpeedStep Technology.

[Enabled] Enables the EIST to adjust CPU voltage and core frequency dynamically. It can decrease average power consumption and average heat production.

[Disabled] Disables EIST.

▶ **Intel Turbo Boost [Enabled]***

Enables or disables the Intel® Turbo Boost. This item appears when the installed CPU supports this function.

[Enabled] Enables this function to boost CPU performance automatically above rated specifications when system request the highest performance state.

[Disabled] Disables this function.

▶ **Enhanced Turbo [Auto]**

Enables or disables Enhanced Turbo function for all CPU cores to boost CPU performance.

[Auto] This setting will be configured automatically by BIOS.

[Enabled] All CPU cores would be increased to maximum turbo ratio.

[Disabled] Disables this function.

▶ **CPU Base Clock (MHz) [Default]**

Sets the CPU Base clock. You may overclock the CPU by adjusting this value. Please note that overclocking behavior and stability is not guaranteed. This item appears when a CPU that support this function is installed.

▶ CPU Base Clock Apply Mode [Auto]*

Sets the applying mode for adjusted CPU base clock.

[Auto] This setting will be configured automatically by BIOS.

[Next Boot] CPU will run the adjusted CPU base clock at next boot.

[Immediate] CPU runs the adjusted CPU base clock immediately.

[During Boot] CPU will run the adjusted CPU base clock during boot.

▶ Extreme Memory Profile (X.M.P.) [Disabled]

X.M.P. (Extreme Memory Profile) is the overclocking technology by memory module. This item will be available when the memory modules that support X.M.P. is installed.

[Disabled] Disables this function.

[Profile 1] Uses profile1 settings of XMP memory module.

[Profile 2] Uses profile2 settings of XMP memory module.

▶ DRAM Frequency [Auto]

Sets the DRAM frequency. Please note the overclocking behavior is not guaranteed.

▶ Adjusted DRAM Frequency

Shows the adjusted DRAM frequency. Read-only.

▶ Memory Try It ! [Disabled]

It can improve memory compatibility or performance by choosing optimized memory preset.

▶ DRAM Timing Mode [Link]

Selects the memory timing mode.

[Link] Allows user to configure the DRAM timing for all memory channel.

[UnLink] Allows user to configure the DRAM timing for respective memory channel.

▶ Advanced DRAM Configuration

Press <Enter> to enter the sub-menu. User can set the memory timing for each/ all memory channel. The system may become unstable or unbootable after changing memory timing. If it occurs, please clear the CMOS data and restore the default settings. (Refer to the Clear CMOS jumper/ button section to clear the CMOS data, and enter the BIOS to load the default settings.)

▶ Memory Fast Boot [Auto] *

Enables or disables the initiation and training for memory every booting.

[Auto] The setting will be configured automatically by BIOS.

[Enabled] System will completely keep the archives of first initiation and training for memory. So the memory will not be initialed and trained when booting to accelerate the system booting time.

[Disabled] The memory will be initialed and trained every booting.

▶ CPU Core/ GT Voltage Mode [Auto]*

Selects the control mode for CPU Core/ GT voltages.

- [Auto] This setting will be configured automatically by BIOS.
- [Adaptive Mode] Sets the adaptive voltage automatically for optimizing the system performance.
- [Override Mode] Allows you to set the voltage manually.
- [Offset Mode] Allows you to set the offset voltage and select the voltage offset mode.
- [Adaptive + Offset] Sets the adaptive voltage automatically and allows you to set the offset voltage.
- [Override + Offset] Allows you to set the voltage and the offset voltage manually.

▶ CPU Voltages control [Auto]

These options allows you to set the voltages related to CPU. If set to **Auto**, BIOS will set these voltages automatically or you can set it manually.

▶ DRAM Voltages control [Auto]

These options allows you to set the voltages related to memory. If set to **Auto**, BIOS will set these voltages automatically or you can set it manually.

▶ CPU Memory Changed Detect [Enabled]*

Enables or disables the system to issue a warning message during boot when the CPU or memory has been replaced.

- [Enabled] The system will issue a warning message during boot and then you have to load the default settings for new devices.
- [Disabled] Disables this function and keeps the current BIOS settings.

▶ OC Quick View Timer [3 Sec]*

Sets a time to allow the BIOS to show the variations of CPU base clock, CPU ratio, Ring ratio and DRAM ratio if any. If set to Disabled, BIOS will not show the variations when you change the CPU base clock, CPU ratio, Ring ratio and DRAM ratio.

▶ CPU Specifications

Press <Enter> to enter the sub-menu. This sub-menu displays the information of installed CPU. You can also access this information menu at any time by pressing [F4]. Read only.

▶ CPU Technology Support

Press <Enter> to enter the sub-menu. The sub-menu shows the key features of installed CPU. Read only.

▶ MEMORY-Z

Press <Enter> to enter the sub-menu. This sub-menu displays all the settings and timings of installed memory. You can also access this information menu at any time by pressing [F5].

▶ DIMM1~4 Memory SPD

Press <Enter> to enter the sub-menu. The sub-menu displays the information of installed memory. Read only.

► CPU Features

Press <Enter> to enter the sub-menu.

► Hyper-Threading [Enabled]

Intel Hyper-Threading technology treats the multi cores inside the processor as multi logical processors that can execute instructions simultaneously. In this way, the system performance is highly improved. This item appears when the installed CPU supports this technology.

[Enabled] Enables Intel Hyper-Threading technology.

[Disabled] Disables this item if the system does not support HT function.

► Active Processor Cores [All]

Allows you to select the number of active CPU cores.

► Limit CPUID Maximum [Disabled]

Enables or disables the extended CPUID value.

[Enabled] BIOS limits the maximum CPUID input value to circumvent boot problems with older operating system that do not support the processor with extended CPUID value.

[Disabled] Use the actual maximum CPUID input value.

► Execute Disable Bit [Enabled]

Intel's Execute Disable Bit functionality can prevent certain classes of malicious **buffer overflow** attacks where worms attempt to execute code to damage the system. It is recommended that keeps this item enabled always.

[Enabled] Enables NO-Execution protection to prevent the malicious attacks and worms.

[Disabled] Disables this function.

► Intel Virtualization Tech [Enabled]

Enables or disables Intel Virtualization technology.

[Enabled] Enables Intel Virtualization technology and allows a platform to run multiple operating systems in independent partitions. The system can function as multiple systems virtually.

[Disabled] Disables this function.

► Intel VT-D Tech [Disabled]

Enables or disables Intel VT-D (Intel Virtualization for Directed I/O) technology.

► Hardware Prefetcher [Enabled]

Enables or disables the hardware prefetcher (MLC Streamer prefetcher).

[Enabled] Allows the hardware prefetcher to automatically pre-fetch data and instructions into L2 cache from memory for tuning the CPU performance.

[Disabled] Disables the hardware prefetcher.

▶ **Adjacent Cache Line Prefetch [Enabled]**

Enables or disables the CPU hardware prefetcher (MLC Spatial prefetcher).

[Enabled] Enables adjacent cache line prefetching for reducing the cache latency time and tuning the performance to the specific application.

[Disabled] Enables the requested cache line only.

▶ **CPU AES Instructions [Enabled]**

Enables or disables the CPU AES (Advanced Encryption Standard-New Instructions) support. This item appears when a CPU supports this function.

▶ **Intel Adaptive Thermal Monitor [Enabled]**

Enables or disables the Intel adaptive thermal monitor function to protect the CPU from overheating.

[Enabled] Throttles down the CPU core clock speed when the CPU is over the adaptive temperature.

[Disabled] Disables this function.

▶ **Intel C-State [Auto]**

Enables or disables the Intel C-state. C-state is a processor power management technology defined by ACPI.

[Auto] This setting will be configured automatically by BIOS.

[Enabled] Detects the idle state of system and reduce CPU power consumption accordingly.

[Disabled] Disable this function.

▶ **C1E Support [Disabled]**

Enables or disables the C1E function for power-saving in halt state. This item appears when **Intel C-State** is enabled.

[Enabled] Enables C1E function to reduce the CPU frequency and voltage for power-saving in halt state.

[Disabled] Disables this function.

▶ **Package C State limit [Auto]**

This item allows you to select a CPU C-state level for power-saving when system is idle. The options of C-state depend on the installed CPU. This item appears when **Intel C-State** is enabled.

▶ **CFG Lock [Enabled]**

Lock or un-lock the MSR 0xE2[15], CFG lock bit.

[Enabled] Locks the CFG lock bit.

[Disabled] Un-locks the CFG lock bit.

▶ **EIST [Enabled]**

Enables or disables the Enhanced Intel® SpeedStep Technology. This item will appear when **OC Explore Mode** is set to **Normal**.

[Enabled] Enables the EIST to adjust CPU voltage and core frequency dynamically. It can decrease average power consumption and average heat production.

[Disabled] Disables EIST.

▶ **Intel Turbo Boost [Enabled]**

Enables or disables the Intel® Turbo Boost. This item is for **Normal mode** and appears when a CPU that support Turbo Boost is installed.

[Enabled] Enables this function to boost CPU performance automatically over specification when system request the highest performance state.

[Disabled] Disables this function.

▶ **Long Duration Power Limit (W) [Auto]**

Sets the long duration TDP power limit for CPU in Turbo Boost mode.

▶ **Long Duration Maintained (s) [Auto]**

Sets the maintaining time for Long duration power Limit(W).

▶ **Short Duration Power Limit (W) [Auto]**

Sets the short duration TDP power limit for CPU in Turbo Boost mode.

▶ **CPU Current Limit (A) [Auto]**

Sets maximum current limit of CPU package in Turbo Boost mode. When the current is over the specified value, the CPU will automatically reduce the core frequency for reducing the current.

▶ **FCLK Frequency [Auto]**

Sets FCLK frequency. Lower FCLK frequency may help you to set higher base clock frequency.

▶ **DMI Link Speed [Auto]**

Sets DMI speed.

M-FLASH

M-FLASH provides the way to update BIOS with a USB flash drive. Please download the latest BIOS file that matches your motherboard model from MSI website, save the BIOS file into your USB flash drive. And then follow the steps below to update BIOS.

1. Insert the USB flash drive that contains the update file into the computer.
2. Click on **M-FLASH** tab, a demand message will be prompted. Click on **Yes** to reboot and enter the flash mode.

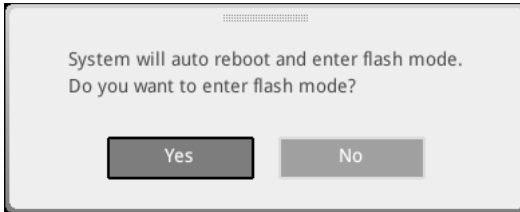

3. The system will enter the flash mode and a file selection menu will appear after rebooting.

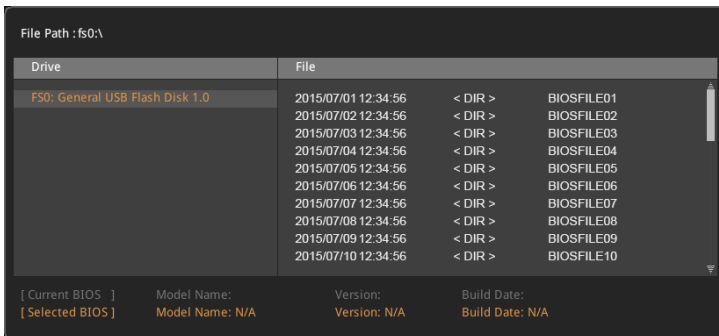

4. Select a BIOS file to perform the BIOS update process.
5. After the flashing process is 100% completed, the system will reboot automatically.

OC PROFILE



► Overclocking Profile 1/ 2/ 3/ 4/ 5/ 6

Overclocking Profile 1/ 2/ 3/ 4/ 5/ 6 management. Press <Enter> to enter the sub-menu.

► Set Name for Overclocking Profile 1/ 2/ 3/ 4/ 5/ 6

Name the current overclocking profile.

► Save Overclocking Profile 1/ 2/ 3/ 4/ 5/ 6

Save the current overclocking profile.

► Load Overclocking Profile 1/ 2/ 3/ 4/ 5/ 6

Load the current overclocking profile.

► Clear Overclocking Profile 1/ 2/ 3/ 4/ 5/ 6

Clear the current overclocking profile.

► OC Profile Load from ROM

Load OC profile from BIOS ROM.

► OC Profile Save to USB

Save OC profile to the USB flash drive. The USB flash drive should be FAT/ FAT32 format only.

► OC Profile Load from USB

Load OC profile from the USB flash drive. The USB flash drive should be FAT/ FAT32 format only.

HARDWARE MONITOR

Current Temperature & Speed information



► Current Temperature & Speed information

Shows the current CPU temperature, system temperature and fans' speeds.

► Fan control field

This motherboard provides a fan speed control feature call **Smart Fan**. Please check the **Smart Fan Mode** box to enable the Smart Fan. It automatically controls fan speed depending on the current CPU temperature and to keep it with a specific operating speed. When the current CPU temperature is over/ under the setting temperature, the CPU/ system fan will run at the corresponding speed. In this field, drag the color buttons to configure the fan speeds and the target temperatures of CPU for four level.

Important

The changing will achieve after you save the changes and reboot the system.

► Function Buttons

- [All Full Speed] Configures CPU and system fans to run at full operating speed.
- [All Set Default] Configures CPU and system fans to run at default operating speed.
- [All Set Cancel] Discards current changes and restores previous operating speeds to CPU and system fans .

► Voltage display

Shows the current voltages of CPU, system and memory.

Software Description

Installing Windows® 7/ 8.1/ 10

1. Power on the computer.
2. Insert the Windows® 7/ 8.1/ 10 disc into your optical drive.
3. Press the **Restart** button on the computer case.
4. For windows 8.1/ 10, skip this step. For Windows 7, access the BIOS menu **SETTING > Advanced > Windows OS Configuration > Windows 7 Installation** and set the item to enabled, save changes and restart.
5. Press **F11** key during the computer POST (Power-On Self Test) to get into Boot Menu.
6. Select your optical drive from the Boot Menu.
7. Press any key when screen shows **Press any key to boot from CD or DVD...** message.
8. Follow the instructions on the screen to install Windows® 7/ 8.1/ 10.

Note: It is suggested to plug in your USB Keyboard/USB Mouse to the leftmost USB port when installing Windows 7.

Installing Drivers

1. Start up your computer in Windows® 7/ 8.1/ 10.
2. Insert MSI® Driver Disc into your optical drive.
3. The installer will automatically appear and it will find and list all necessary drivers.
4. Click **Install** button.
5. The software installation will then be in progress, after it has finished it will prompt you to restart.
6. Click **OK** button to finish.
7. Restart your computer.

Installing Utilities

Before you install utilities, you must complete drivers installation.

1. Insert MSI® Driver Disc into your optical drive.
2. The installer will automatically appear.
3. Click **Utilities** tab.
4. Select the utilities you want to install.
5. Click **Install** button.
6. The utilities installation will then be in progress, after it has finished it will prompt you to restart.
7. Click **OK** button to finish.
8. Restart your computer.

COMMAND CENTER

COMMAND CENTER is a user-friendly software and exclusively developed by MSI, helping users to adjust system settings and monitor status under OS. With the help of COMMAND CENTER, making it possible to achieve easier and efficient monitoring process and adjustments than that under BIOS. In addition, the COMMAND CENTER can be a server for mobile remote control application.

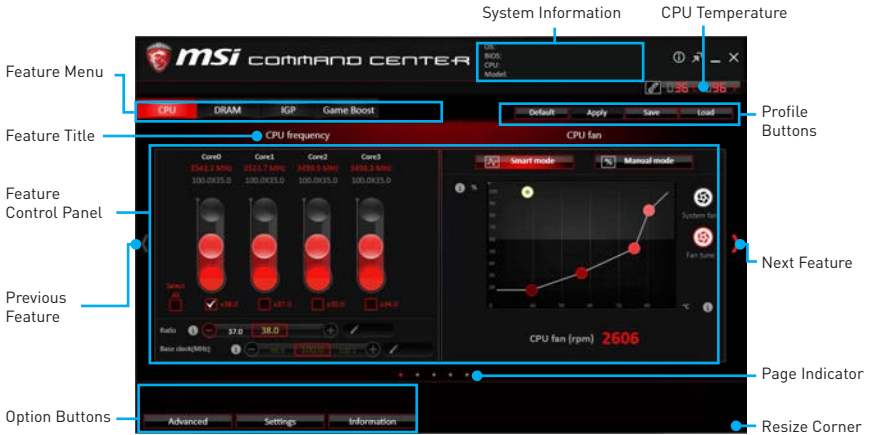

Profile Buttons



- **Default** - load the default values for the current feature.
- **Apply** - apply your changes.
- **Save** - store values in the file with individual file extension.
- **Load** - load the values from the file.

Important

Every time you shut down the system, the configured setting will be restored to the factory default. If you want to use the saved settings, you have to load it every time by clicking the **Load** and **Apply** buttons.

CPU Frequency

CPU Frequency control panel allows you to change CPU Ratio and Base clock. You can see the current frequency of each CPU core on the top of the panel.



CPU Fan

CPU Fan control panel provides **Smart mode** and **Manual Mode**. You can switch the control mode by clicking the **Smart Mode** and **Manual Mode** buttons on the top of the CPU Fan control panel.

- **Manual Mode** - allows you to manually control the CPU fan speed by percentage.
- **Smart Mode** - a linear fan speed control feature. The control panel contains 4 dots allows you to drag and adjust the Smart Speed slopes. The fan speed will be changed along these lines with CPU temperature. The white dot will create fan chart in real time.
- **System Fan Button** - to open the system fan control panel in new window.
- **Fan Tune Button** - to automatically optimize the smart fan setting.



Manual Mode

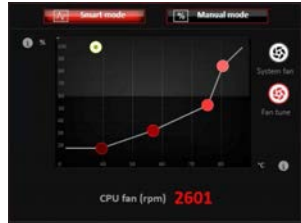

Smart Mode

CPU Voltage

CPU Voltage control panel allows you to control the CPU voltage.



DRAM Frequency & DRAM Voltage

- **DRAM Frequency** - Shows the DRAM clock, ratio and frequency.
- **DRAM Voltage** - Allows you to adjust the DRAM voltage. The risky values are displayed in red.



IGP Frequency & GT Voltage

- **IGP Frequency** - Allows you to adjust the IGP ratio, and shows the IGP clock, ratio and frequency.
- **GT Voltage** - Allows you to adjust the GT voltage. The risky values are displayed in red.

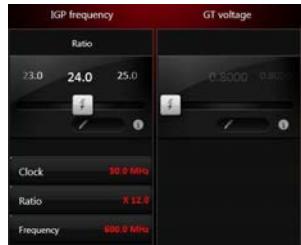

GAME BOOST

GAME BOOST provides a specified CPU frequency for overclocking the CPU.



Option Buttons - Advanced

When click the **Advanced** button, The **Voltage**, **Fan** and **DRAM** icons will appear.



- **Voltage** - allows you to adjust advanced voltage values of CPU and chipset.
- **Fan** - allows you to control the system fans speed.
- **DRAM** - shows the current Advanced DRAM parameters, and allows you to change the settings by selecting values from the drop-down menu on the right hand side.
- **Sensor** - allows you to monitor your motherboard temperature and fan speed with the virtual thermal image. You can drag and drop the fan icons to new locations. When you press the **Cooling** button, all fans will run at full speed.

Option Buttons - Setting

When click the **Setting** button, The **Record**, **Warning** and **Mobile Control** icons will appear.



- **Record** - allows you to monitor the status of voltage, fan speed and temperature in real time.
 - To filter record charts, select the check box next to the items.
 - When click the **Play** button, the chart pane will start to show the recording chart. If you want to check the value of a specific spot on chart, please move the orange vertical line to the spot.
 - History Record stores the data and names with date and time.
 - To make a history record: Select items and click the **Record** button. When finished, click the **Record** button again. The data will be stored in the drop-down menu.
 - To load a record, click the drop-down menu and select one from the list.
 - To delete a record, select the record that you want to delete, and click the **Trash Can** icon.

- **Warning** - contains fields of voltage, fan speed and temperature for you to set the threshold values. When system detects the status over your settings, a warning message will pop-up.



- **Mobile Control** - is only available for the motherboard with the built-in WiFi module. It allows you to enable/disable the COMMAND CENTER Remote Server. Please refer to the instruction on the Mobile Control control panel.
- **To start remote control: (optional)**
 1. Download and install **MSI® COMMAND CENTER APP** to your mobile device.
 2. Enable **COMMAND CENTER Remote Server** on the **Mobile Control** panel.
 3. Enable **SoftAP Management**.
 4. Enter **SSID** and **Password**, and then click the **Apply** button.
 5. Activate Wi-Fi® on your mobile device and connect to SoftAP with the SSID.
 6. Run **MSI® COMMAND CENTER APP** on your mobile device.
 7. Find the IP address on the **SoftAP Management Setting** area, and enter the IP address on your **MSI® COMMAND CENTER APP** to link your system.
 8. Press **Refresh** on the **MSI® COMMAND CENTER APP** to verify that monitoring and OC functions are working properly.

Option Buttons - Information

When click the **Information** button, The **Motherboard, CPU, Memory** and **HW monitor** icons will appear.



You can click the icons to open the related information.

Gadget Mode

COMMAND CENTER provides a gadget mode to monitor the system status. You can switch between gadget mode and full mode by clicking the arrow icon  on the top left.

- **To arrange gadgets:**
 1. Click the Spanner icon  on the Gadget mode, a configuration panel will slide out.
 2. Select the check box next to the items.
 3. Click the **Close** button.

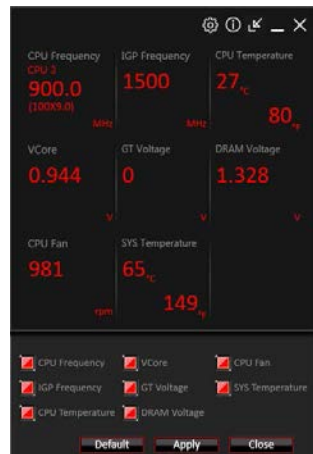

LIVE UPDATE 6

LIVE UPDATE 6 is an application for the MSI® system to scan and download the latest drivers, BIOS and utilities. With LIVE UPDATE 6, you don't need to search the drivers on websites, and don't need to know the models of motherboard and graphics cards. LIVE UPDATE 6 will download the appropriate drivers automatically.

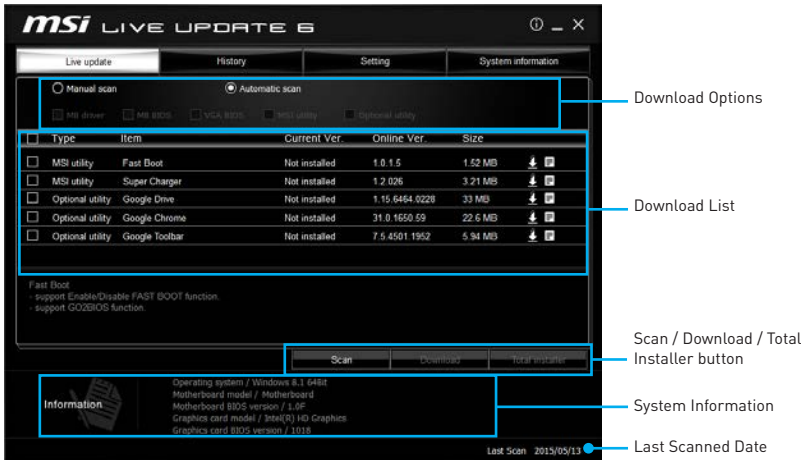

There are **Live Update**, **History**, **Setting** and **System Information** tabs at the top. You can click the tab to switch the control panel.

- **Live Update** - When you launch LIVE UPDATE 6, you will see the Live update tab at first. This tab allows you to select files to download. You can also read the relevant information by clicking the information icon  on the right of the item listed.
- **History** - shows the downloading history.
- **Setting** - allows you to specify the frequency that LIVE UPDATE 6 remind you to update.
- **System Information** - displays the information of the system.

Updating The System

This section describes how to update your system with LIVE UPDATE 6. Please follow the steps below:

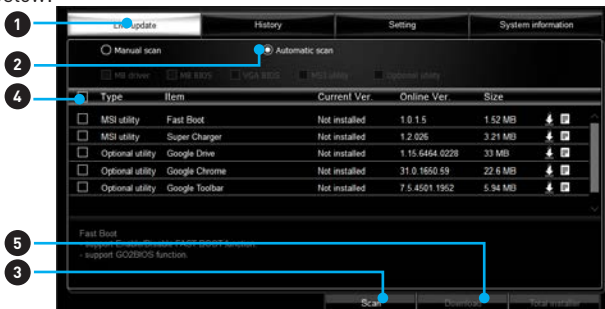

1. Select the **Live Update** tab.

- Choose **Automatic scan**, system will automatically scan all the items and search for the latest update files. Or you can choose **Manual scan** and select the items you wish to scan.
- Click the **Scan** button at the bottom. It may take several moments to complete the process.
- When the download list appears, please select the items you intend to update.
- Click **Download** button at the bottom.
- When **Save Path** prompt, you can specify a download directory.

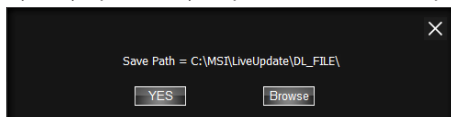

- When downloading you will see the screen below. It may take several moments to complete the process.

Type	Item	Latest Ver.	Size	Download
MSI utility	Fast Boot	1.0.1.5	1.52 MB	<div style="width: 46%;"></div> 46 %
MSI utility	Super Charger	1.2.026	3.21 MB	

- To install the applications, simply unpack the packages and install.

Total Installer

Total Installer is a convenient feature to simplify frequent installing procedure. To use Total Installer:

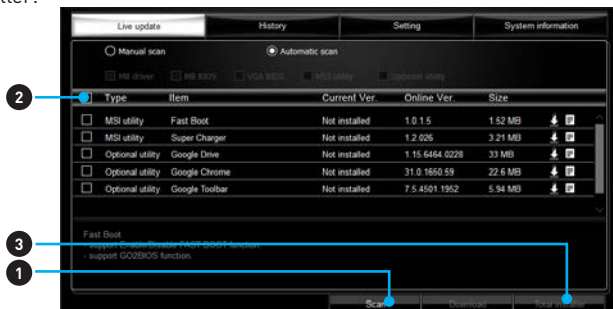

- Scan** updates in **Live Update** tab.
- Check the **Select All** check-box you intend to update.
- Click the **Total Installer** button. LIVE UPDATE 6 will automatically install them.
- When prompted, click **OK** to complete the Total Installer procedure
- Reboot your system.

GAMING APP

GAMING APP is an application designed to quickly control your system for improving gaming performance.

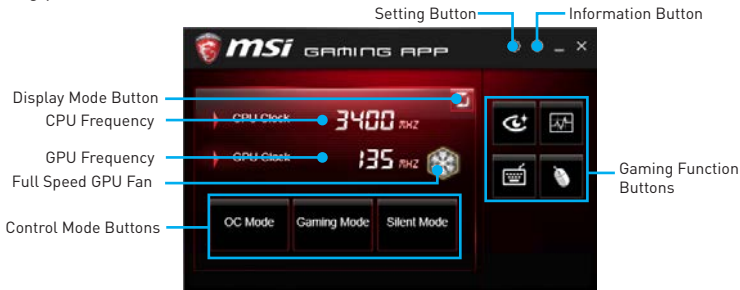

- **Setting Button** - allows you to run GAMING APP when Windows starts.
- **Information Button** - shows the information of this application.
- **Display Mode Button** - allows you to switch between **CPU clock display mode** and **Status bar display mode**.
- **CPU Frequency** - shows the current CPU frequency.
- **Control Mode Buttons**
 - **OC Mode** - automatically overclock the CPU.
 - **Gaming Mode** - force the CPU to stay at maximum clock speed limited by CPU specification.
 - **Silent Mode** - sets the CPU clock to the default value.
- **Gaming Function Buttons** - allows you to use **Eye Rest**, **OSD**, **Gaming Hotkey** and **Gaming Mouse Control** functions.

Eye Rest

Eye Rest allows you to optimize the display on your monitor.



- **EyeRest** - reduces blue-light of your LED backlit screen, in order to protect your eyes.
- **Gaming** - automatically increase contrast ratio of your screen.
- **Movie** - automatically increase dynamic contrast ratio of your screen.
- **Customize** - allows you to adjust gamma, contrast and color balance for your screen.
- **Default** - loads the default settings.

OSD Setting Panel

Use the OSD setting panel to specify information within on-screen display (OSD).



- **Apply Button** - allows you to accept selections.

Gaming Hotkey

Gaming Hotkey provides instant control of the system through user defined hotkeys.

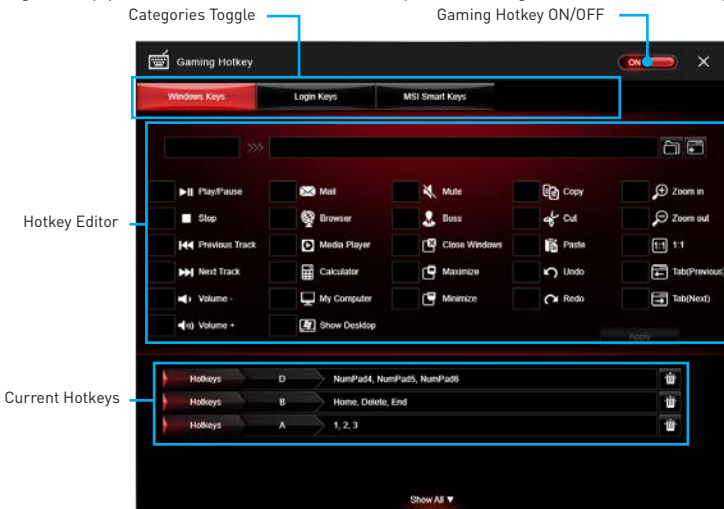

- **Gaming Hotkey ON/OFF** - allows you to turn ON/OFF the Gaming Hotkey function.
- **Categories Toggle** - allows you to toggle over the Hotkey categories .
 - **Windows Keys** - allows you to define hotkeys to replace Windows default keyboard shortcuts.
 - **Login Keys** - provides hotkey login function.
 - **MSI Smart Keys** - allows you to define hotkeys for MSI Smart Keys.
- **Hotkey Manager** - allows you to create, edit and delete hotkeys.
- **Current Hotkeys** - shows all existing hotkeys.

Important

- The **Caps Lock**, **Num Lock**, **Scroll Lock**, **Window Home**, **Application** and **BackSpace** keys can not be used as hot-keys.
- Some key combinations are reserved for use by Microsoft Windows and can not be assigned as a hotkey.

Gaming Mouse Control

Gaming Mouse Control provides mouse macro function. You can also use it to change DPI of your mouse.



- **Delay Time** - allows you to input delay time and click the **Add** button to insert a delay in the macro.
- **Macro Hot Key** - allows you to assign a hotkey from A to Z to activate the macro.
- **Mouse Action** - assigns mouse actions to the macro.
 - **New** - captures the mouse coordinate and add to the macro.
 - **Left** - add a left-click to the macro.
 - **Middle** - add a middle-click to the macro.
 - **Left** - add a left-click to the macro.
- **Action List** - shows the actions of the current macro.
- **Edit Buttons** - there 3 buttons for editing the macro.
 - **Run** - activates the macro.
 - **Delete** - removes the selected action from the macro.
 - **Clear** - removes all actions from the macro.
- **Load Button** - allows you to load a macro.
- **Save Button** - allows you to save the macro to a file.
- **DPI Setting** - allows you select the mouse DPI from the drop-down menu.
- **Default Button** - reverts to the default DPI setting.
- **DPI Hot Key** - allows you to assign a hotkey from A to Z to activate the DPI setting. Please note that you muse hold the hotkey to keep the DPI setting. When you release the hotkey, the DPI setting will be reverted to default.
- **Test Area** - allows you to test the mouse movement.
- **Clear Button** - clears the test area.

M-CLOUD

M-CLOUD is an application of MSI network sharing. It allows you to turn your computer into Wi-Fi AP. It can also transfer files between your MSI computers.

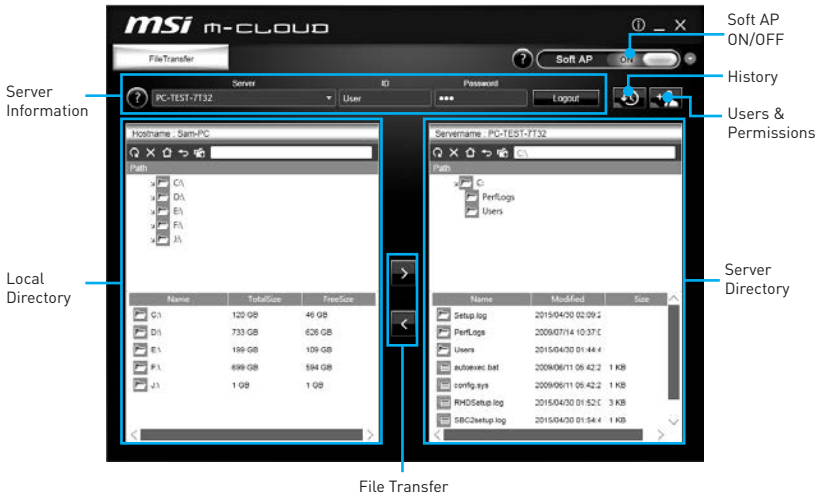

- **Soft AP ON/OFF** - click on the **Soft AP ON/OFF** button to enable virtual Wi-Fi AP.
- **Server Information** - indicate information of current server connection.
- **History** - click on the **History** button to view file transfer history.
- **Users & Permissions** - click on the **Users & Permissions** button to open the **Users & Permissions Management** window.
- **Local/ Server Directory** - you can upload or download files between the local and the server. There 5 icons on the toolbar at the top of Local/ Server Directory.
 - **Refresh** - refresh the local/ server directory.
 - **Delete** - you needs delete permission to delete files.
 - **Root Folder**- navigate to root folder.
 - **Up a Level** - navigate up one directory level.
 - **New Folder** - you needs delete permission to create a new folder.
- **File Transfer** - click **>** button to upload files from the local to the server. Click **<** button to download files from the server to the local.

Setting up Soft AP (optional)

The Soft AP function is only available for the motherboard with the built-in WiFi module. You can share your network connection to your smartphones, tablets and laptops with the Soft AP function.

Important

- You must have an active network connection and an installed Wi-Fi module to enable Soft AP.
- If you connect to Internet by using **PPPoE**, you should check **Allow other people to use this connection** when set up a new connection.

To use Soft AP:

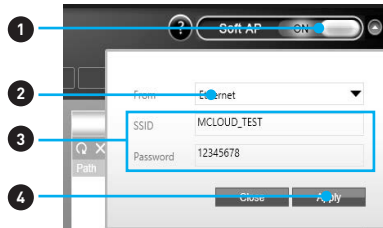

1. Click the **Soft AP** button to **ON** and the **Soft AP** dialogue will pop up.
2. Select an existing network connection.
3. Fill in Wi-Fi network name (**SSID**) and network password.
4. Click **Apply** button to complete.

Installing Cloud Storage

M-CLOUD needs a connection to **Google Drive** or **Dropbox** in order to detect your available servers.

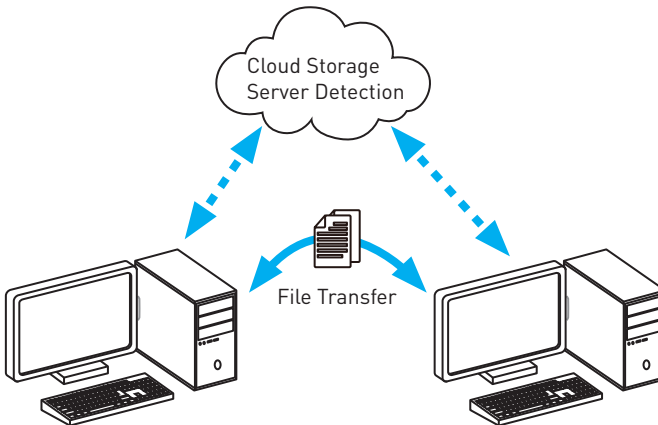

Managing User Accounts

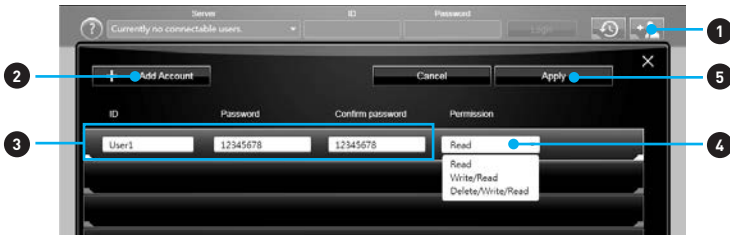

This section describes how to create/ remove a user account and configure individual access permissions.



1. Click the **Users & Permissions** button and the **Users & Permissions Management** window will pop up.
2. Click **Add Account** button create a new user account.
3. Fill in user's **ID**, **password** and **Confirm Password** fields.
4. Select permission for the user account.
5. Click **Apply** button to complete.



Once you create an account 3 management icons will appear on the right hand side.

-  **Delete** - delete the user account.
-  **Unlock/ Lock** - unlock/ lock the user account.
-  **Edit** - change the user password and permission.

Transferring Files

This section describes how to transfer files between your local computer and a server.

Important

- Before using the M-CLOUD to transfer files, you need to connect both the local computer and the server to either Google Drive or Dropbox properly with the same user account.
- To allow your computers to communicate through the firewall with M-CLOUD, you have to open ports **24680~24780**.

1. Activate **M-CLOUD** both on the local computer and the server.

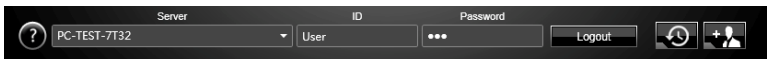

2. Select a server from the bar
3. Enter User **ID** and **Password** and click the Login button.
4. You can select files from **Local/ Server Directory** and then click the **File Transfer** button to upload or download them. You can also drag the files from one side and drop them on the other side.

RAMDISK

RAMDISK creates a virtual RAM drive using the available memory in your computer, the performance of the RAMDISK is faster than an SSD and hard drive. RAMDISK allows you to store any temporary information on it. Furthermore, using the RAMDISK will extend your SSD's life by sparing it from excessive reading and writing.

Creating a RAM Disk

When **RAMDISK** is started, it will create a default RAM disk. If you want to change settings, refer to following instructions.

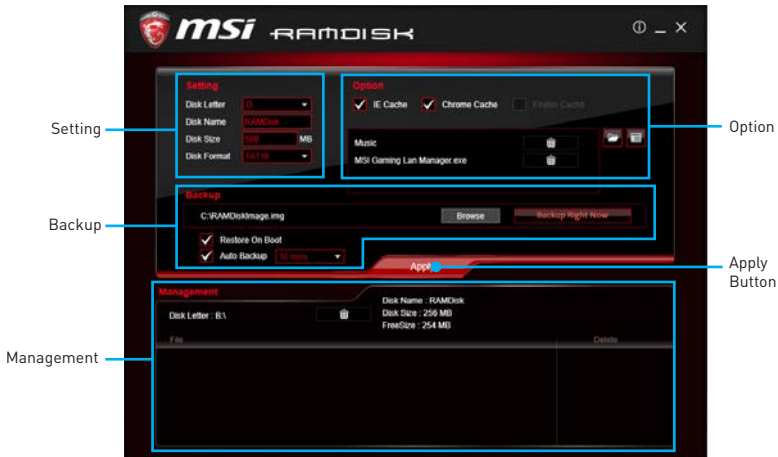

- **Setting** - specify **Letter, Name, Size** and **Format** of the RAM disk.
- **Option** - select browser temporary files to save/load on the RAM disk. You can also add software files to improve reading speed.
- **Backup** - specify backup and restore settings to prevent data loss. All files will be lost each time the RAMDISK is stopped if you do not backup.
 - **Browse Button** - set the path to the image file.
 - **Backup Right Now Button** - manually backup files.
 - **Restore On Boot** - check this box to have the image file loaded automatically when RAMDISK starts.
 - **Auto Backup** - check this box to backup automatically over a period of time.
- **Apply Button** - allows you to apply changes.
- **Management** - shows RAMDISK information and allows you to delete files.

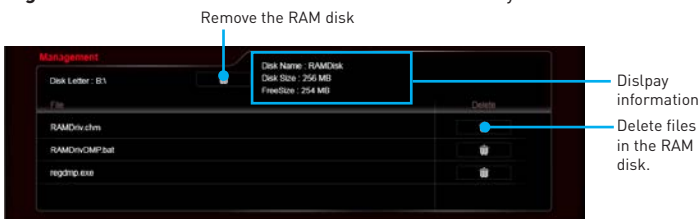

Killer Network Manager

The Killer Network Manager software installs with the Killer LAN driver. Once installed, the Killer Network Manager icon shows on system tray (the right bottom corner of the screen). Mouse right click on the tray icon to show the application window.

In case no icon is shown on the system tray, it is possible to activate Killer Network Manager manually by clicking **Start > Programs > MSI > Killer Network Manager**.

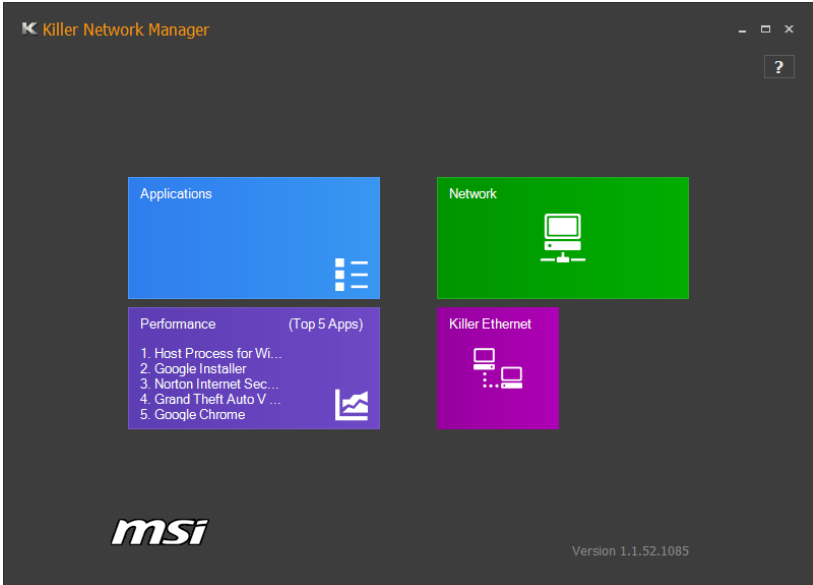

- **Applications** - displays currently using network bandwidth applications.
- **Performance** - shows top 5 applications by total traffic, allows you to monitor network bandwidth usage.
- **Network** - allows you to setup bandwidth.
- **Killer Ethernet** - shows your ethernet setting information.

Configuring Bandwidth

Before using the Killer network for the first time, you should configure default Internet upload and download speed.

To configure bandwidth:

1. Select the **Network** block in Killer Network Manager.
2. Enter a value into the **Upload Speed** field.
3. Enter a value into the **Download Speed** field.
4. Check **Enable Bandwidth Control** to allow the Killer Network Manager to manage the bandwidth.

Nahimic

Nahimic is designed to offer the best audio experience it contains 6 audio effects, 3 microphone effects and HD Audio Recorder.

Installation and Update

Nahimic is included in the audio driver. If you need to install it or update it, please use the **Driver Disc** with your motherboard or download the driver from MSI's official website.

Audio Tab

From this tab, you can access all of Nahimic's audio effects, audio profiles and settings.



- **Profiles** - allows you to adjust the 6 audio effects to your current listening experience.
 - **Music** profile applies for any kind of mono or stereo music.
 - **Gaming** profile applies for any kind of stereo or multichannel video game.
 - **Movie** profile applies for any kind of stereo or multichannel video content.
- **Audio Effects** - allows you to separately control any of the 6 audio effects.
 - **Bass Boost** - increases the energy in low frequencies up to +12 dB.
 - **Virtual Surround** - virtualizes the multichannel audio stream and downmixes it in order to retrieve a multichannel listening experience over your stereo headphones or speakers.
 - **Reverb** - increases the feeling of space by applying different types of reverbs corresponding to different room sizes.
 - **Frequency Leveler** - levels the energy of sub-bass, bass, medium and treble to a given threshold in order to maintain a constant level of each type of frequency.
 - **Volume Boost** - controls extra gain up to +6 dB.
 - **Voice Clarity** - boosts the speech in movies, video games and incoming communication up to +6 dB.
- **Reset Button** - restores the current profile to its default values.
- **On/Off Button** - allows you to turn on and off all Nahimic's effects in one click.

Microphone Tab

From this tab, you can access all of Nahimic's microphone effects and settings.



- **Listen to your MIC** - turns the microphone loopback On/Off.
- **Automatic Calibration** - dynamically adjusts the **Noise Gate** threshold and the **Noise Reduction** level by estimating the noise VS. signal rate.
- **Microphone Effects** - allows you to separately control any of the 3 microphone effects.
 - **Voice Leveler** - levels the volume of your voice in order to avoid any saturation and maintains a constant and clear communication.
 - **Noise Gate** - removes the background and the digital noise between segments of speech during your voice communication.
 - **Noise Reduction** - removes the remaining sound that the **Noise Gate** has left on top of your words and sentences.

HD Audio Recorder

From this tab, you can access all of Nahimic's HD Audio Recorder explanations and settings. **XSplit Gamecaster**, **XSplit Broadcaster** and **Open Broadcaster Software** are currently the only softwares supported by HD Audio Recorder.

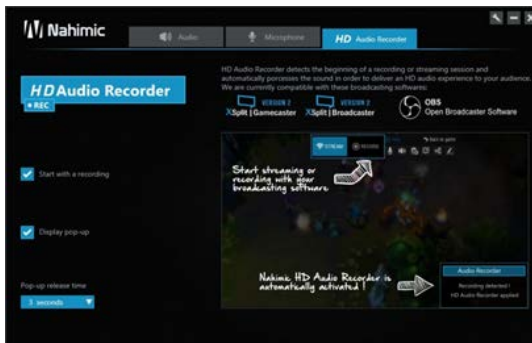

The HD Audio Recorder is automatically launched when a recording session is detected. The launch of the HD Audio Recorder enables HD audio processing over a recording without any need for adjustments. You can disable the HD Audio Recorder by unchecking the **Start with a recording** option in the HD Audio Recorder tab.

Intel® Extreme Tuning Utility

Intel® Extreme Tuning Utility (Intel XTU) is a simple overclocking software for you to tune, test and monitor your system.

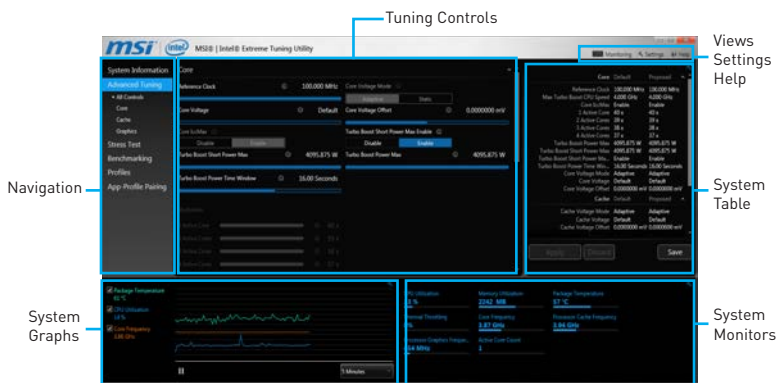

• Views Settings Help

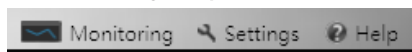

- **Views** - toggles to switch between **Monitoring** and **Show All** view.
- **Settings** - opens the **General Settings** window.
- **Help** - displays the help content for Intel XTU in a separate window.
- **Navigation** - lists all of the major functions of Intel XTU.
 - **System Information** - shows the details about your system.
 - **Advanced Tuning** - changes system settings in a free form.
 - **Stress Test** - tests the stability of your system.
 - **Benchmarking** - analyzes and compares your system's performance against other system profiles.
 - **Profiles** - manages sets of system settings.
 - **App-Profile Pairing** - tunes automatically based on active application.
- **Tuning Controls** - displays the controls for changing the system settings in manual tuning. For stress tests and profiles, this area displays the settings for these features.
- **System Table** - displays information about the current system settings and a summary of your changes.
- **System Graphs** - shows measured system values over a period of time. The system graphs update live as changes are detected in the system. You can customize the system graphs to show the data you need for your overclocking strategy in the system graphs preferences.
- **System Monitors** - shows the range of the value, averages, and the current value. The monitors change color if the monitored values fall into warning or critical zones.

RAID Configuration (optional)

Below are the different types of a RAID.

- RAID 0** breaks the data into blocks which are written to separate hard drives. Spreading the hard drive I/O load across independent channels greatly improves I/O performance.
- RAID 1** provides data redundancy by mirroring data between the hard drives and provides enhanced read performance.
- RAID 5** provides data striping at the byte level and also stripe error correction information. This results in excellent performance and good fault tolerance.
- RAID 10** uses four hard drives to create a combination of RAID 0 and 1 by forming a RAID 0 array from two RAID 1 arrays.

RAID level comparison

	RAID 0	RAID 1	RAID 5	RAID 10
Minimum # drives	2	2	3	4
Data protection	None	Excellent	Excellent	Excellent
Read performance	Excellent	OK	Good	OK
Write performance	Excellent	Good	OK	Good
Capacity utilization	100%	50%	67%~(1-1/n)	50%

Using Intel® Rapid Storage Technology Option ROM

First, you need to set the **SATA mode** to **RAID** in BIOS to create, delete and reset RAID volumes. To enter the IRST Option ROM, reboot and press **Ctrl + I** keys to enter the IRST Option ROM during the POST, the following window will appear.

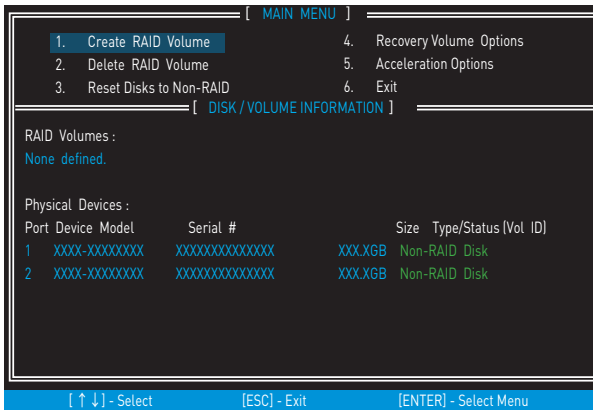

Important

The following procedure is only available with a newly-built system or if you are reinstalling your OS. It should not be used to migrate an existing system to RAID.

Creating RAID Volume

1. Select option **Create RAID Volume** and press **Enter** key. The following screen appears.

```
[ CREATE VOLUME MENU ]
Name : Volume0
RAID Level : RAID1[Mirror]
Disks : Select Disks
Strip Size : N / A
Capacity : XXX.X GB
Sync : N / A
Create Volume

[ HELP ]

RAID 1 : Mirrors data [redundancy].

[ ↑ ↓ ] - Change [TAB] - Next [ESC] - Previous Menu [ENTER] - Select
```

2. Specify a RAID Volume name and then press the **Tab** or **Enter** key to go to the next field
3. Use the **↑ ↓ ←→** arrow keys to select the RAID level best suited to your usage model in RAID Level.
4. In the Disk field, press **Enter** key and use **Space** key to select the disks you want to create for the RAID volume, then click **Enter** key to finish selection. This field will become available according to the selected RAID level.
5. Select the strip size for the RAID array by using the **↑ upper arrow** or **↓ down arrow** keys to scroll through the available values, and pressing the **Enter** key to select and advance to the next field. The available values range from 4KB to 128 KB in power of 2 increments. The strip size should be chosen based on the planned drive usage. Here are some typical values:
RAID0 -128KB / RAID10 - 64KB / RAID5 - 64KB.
6. Select the capacity of the volume in the **Capacity** field. The default value is the maximum volume capacity of the selected disks.



Important

Since you want to create two volumes, this default size (maximum) needs to be reduced. Type in a new size for the first volume. As an example: if you want the first volume to span the first half of the two disks, re-type the size to be half of what is shown by default. The second volume, when created, will automatically span the remainder of two hard drives.

7. Go to the **Create Volume** field and press **Enter**, a WARNING message will appear for you to confirm if you are sure to create the RAID volume. Press **Y** to continue.

Delete RAID Volume

Here you can delete the RAID volume, but please be noted that all data on RAID drives will be lost.



If your system currently boots to RAID and you delete the RAID volume in the IRST Option ROM, your system will become unbootable.

Select option **Delete RAID Volume** from the main menu screen and press **Enter** key to select a RAID volume for deletion. Then press **Delete** key to delete the selected RAID volume. The following screen appears.



Press **Y** key to accept the volume deletion.

Reset Disks to Non-RAID

Select option **Reset Disks to Non-RAID** from the main menu screen and press **Enter** to delete the RAID volume and remove any RAID structures from the drives. Use the **Space** key to select the disks and press **Enter** key. A confirmation sentence will appear below, and then press **Y** key to accept the selection

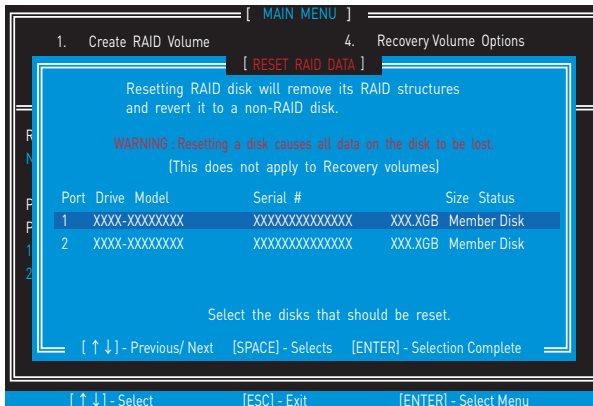

Important

- You will lose all data on the RAID drives and any internal RAID structures when you perform this operation.
- Possible reasons to **Reset Disks to Non-RAID** could include issues such as incompatible RAID configurations or a failed volume or failed disk.

Recovery Volume Options

Select option **Recovery Volume Options** from the main menu screen and press **Enter** to change recovery volume mode. The following screen appears:



Recovery mode will change from Continuous Update to On-Request after you enable **Only Recovery Disk** or **Only Master Disk**.

Degraded RAID Array

A RAID 1, RAID 5 or RAID 10 volume is reported as degraded when one of its hard drive members fails or is temporarily disconnected, and data mirroring is lost. As a result, the system can only utilize the remaining functional hard drive member. To re-establish data mirroring and restore data redundancy, refer to the procedure below that corresponds to the current situation.

RAID Volumes						
ID	Name	Level	Strip	Size	Status	Bootable
0	Volume0	RAID 1(Mirror)	N/A	XXX.XGB	Degraded	Yes

Physical Disks:				
Port	Device Model	Serial #	Size	Type/Status(Vol ID)
1	XXXXXXXXXXXXXX	XXXXXXXXXXXXXX	XXX.XGB	Member Disk (0)
2	XXXXXXXXXXXXXX	XXXXXXXXXXXXXX	XXX.XGB	Member Disk (0)

Press <CTRL-I> to enter Configuration Utility..

Missing Hard Drive Member

1. Power off.
2. Reconnect the hard drive.

3. Reboot to Windows®; the rebuild will occur automatically.

Failed Hard Drive Member

1. Power off.
2. Replace the failed hard drive with a new one that is of equal or greater capacity.
3. Reboot the system to IRST Option ROM by press **Ctrl + I** keys during the POST.
4. Select the port of the destination disk for rebuilding, and then press **Enter**.

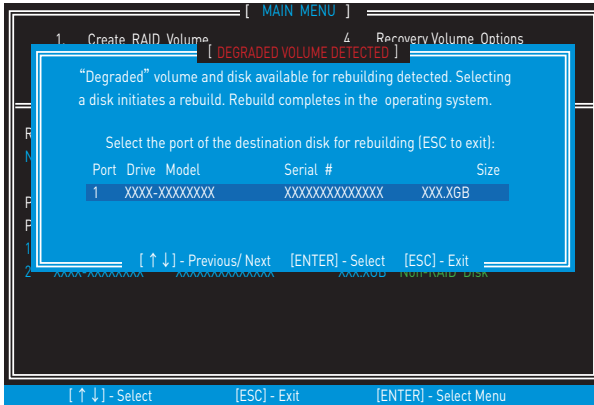

5. Exit IRST Option ROM, reboot to Windows®.
6. When prompted to rebuild the RAID volume, click **Yes**.
7. The **Intel® Rapid Storage Technology** application will be launched. Right-click the new hard drive and select **Rebuild to this Disk**. The **Rebuild Wizard** will be launched which will guide you through the process of rebuilding to the new hard drive.

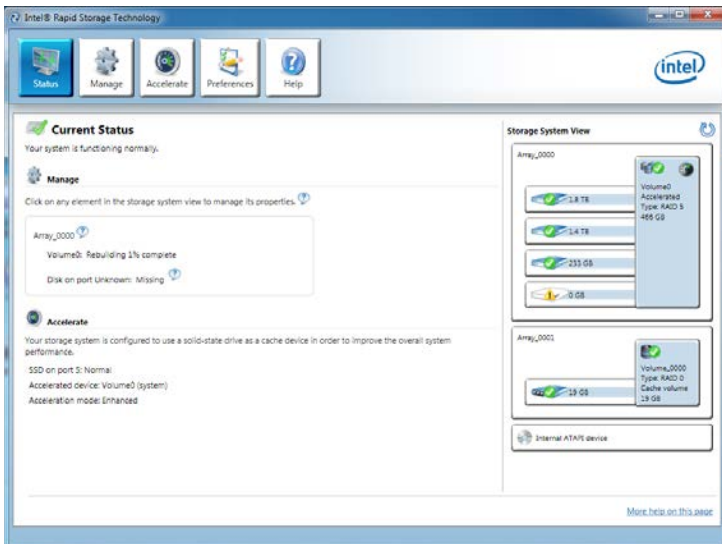

Troubleshooting

Before sending the motherboard for RMA repair, try to go over troubleshooting guide first to see if your got similar symptoms as mentioned below.

The power is not on.

- Connect the AC power cord to an electrical outlet securely.
- Check if all ATX power connectors like **JPWR1~2** is connected from the power supply to the motherboard?
- Some power supply units have a power button on the rear side, make sure the button is turned on.
- Check if the power switch cable is connected to **JFP1** pin header properly.
- Verify the **Clear CMOS** jumper **JBAT1** is set to **Keep DATA**.
- Test with another known working power supply of equal or greater wattage.

The power is on, but no signal to monitor

- Connect the monitor power cord to a electrical outlet securely.
- Make sure the monitor is turned on.
- Select different inputs on the monitor.
- If 3 long beeps are heard, remove all memory modules and try to install only one memory module in the **DIMM2** slot first and then restart the computer.
- If 1 long 2 short beeps are heard, remove and reinstall the graphics card and then restart the computer.
- Test with another known working graphics card.

The computer does not boot after updating the BIOS

- Clear the CMOS.
- Use the secondary BIOS to bootup the system (Only for motherboard with Dual BIOS)

Lost BIOS password

- Clear the CMOS, but that will cause you to lose all customized settings in the BIOS.

There is no audio

- Adjust the volume.
- Connect the speakers/headphones to audio ports on the motherboard rear IO panel.
- Remove secondary speakers/headphones, HDMI cables, USB audio devices.
- Test with another known working speaker or headphone.

There is no network

- Make sure the network chipset driver has been installed.
- Verify if the network cable is properly connected and make sure the LAN port LEDs are properly illuminated.
- Verify your TCP/IP settings.
- Restart or reset your router.
- Test with another known working LAN cable.

The USB device is not working

- Make sure your USB drive driver has been installed.
- Verify if USB device is listed in Windows® Device Manager.
- Connect the USB device to other USB port on the motherboard rear IO panel.