

## **Flying Magnet Crank Trigger Kit General Wiring**

These instructions cover the wiring and general installation tips of all the MSD Flying Magnet Crank Trigger Kits. For installation of the brackets and trigger wheel refer to the enclosed Installation Instructions for each specific kit.

### **SETTING THE AIR-GAP**

The air-gap between the trigger wheel and the non-magnetic pickup is important to the operation of the crank trigger system, however its adjustment does not affect engine power or performance. The proper air-gap will result in a good trigger signal at cranking rpm through high rpm with no interference to the wheel. The optimum setting is generally between 0.050" – 0.080".

With the brackets and trigger wheel mounted (with the arrow on the wheel facing out) position the pickup within 0.050" – 0.080" from the wheel then tighten the locknut (Figure 1). Do not over tighten the locknut.

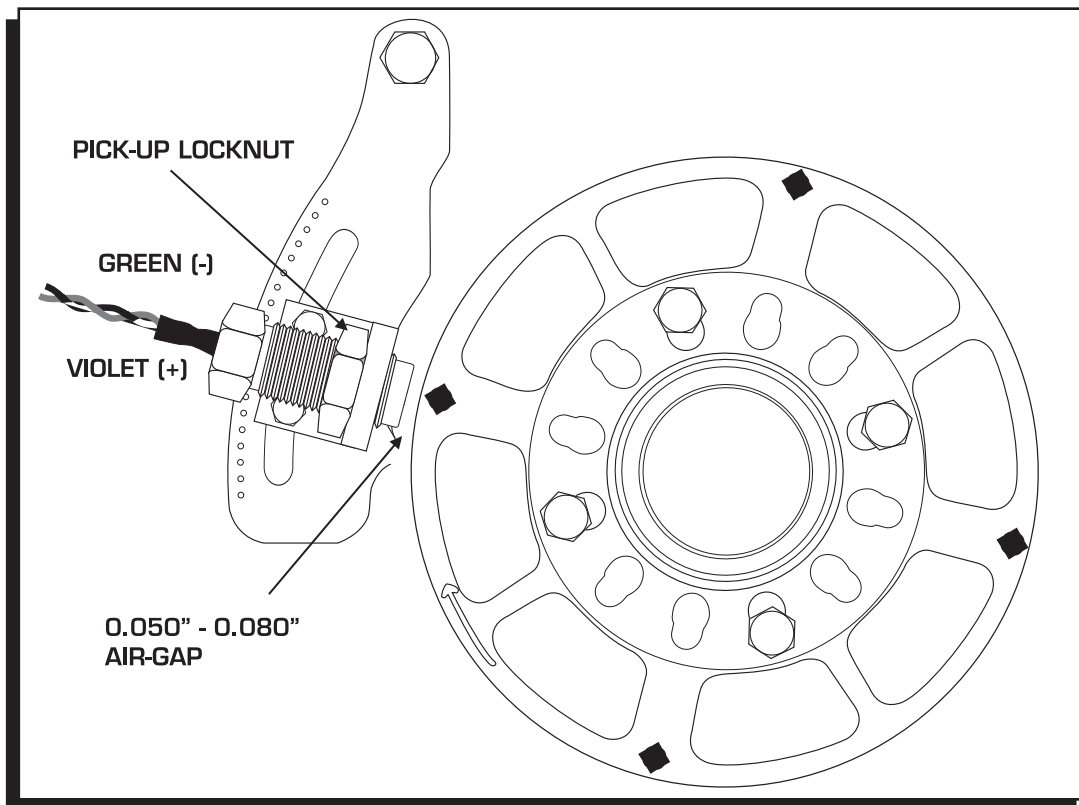

**Figure 1 Setting the Air-Gap.**

## WIRING

The non-magnetic pickup acts much like a coil. The wires are wound around a small piece of iron so that when the magnet passes the pickup a voltage signal is created. This signal is what triggers the MSD Ignition Control. Before completing the wiring, review these tips to ensure the best performance from your crank trigger system.

- Like other pickups, the wiring is polarity sensitive. The Violet wire is Positive and the Green wire is Negative. The resistance of the pickup should be 65 - 85 ohms. MSD offers replacement Non-Magnetic Pickups as PN 8276 for Crank Triggers.
- Twist the wires of the pickup together several times before connecting it to the MSD wiring harness. Twisting these wires together helps reduce the chances of Electro Magnetic Interference (EMI).
- Route the pickup harness along the chassis or engine block. This provides a ground plane that protects against EMI.
- Do not run the trigger wires along the coil primary wiring or spark plug wires. There are high voltages running through these wires so they should not be close to the pickup wires.
- Never use solid core spark plug wires with an MSD Ignition system or crank trigger. A helically or spiral wound suppression wire such as MSD's Heli-Core or 8.5mm Super Conductor Wire must be used.
- If you are running a digital ignition control or aftermarket EFI system, it is highly recommended to use a shielded harness, PN 8862, to prevent the chance of EMI interfering with the trigger signals.

The following diagrams show how to wire the crank trigger to quality MSD Ignition systems.

## SETTING UP THE DISTRIBUTOR

If your distributor is equipped with a centrifugal advance assembly, it must be locked out by welding or bolting the advance mechanism. The distributor has nothing to do with the engine ignition timing when using a crank trigger system. Its function is to distribute the high voltage spark to the spark plugs. To achieve maximum performance from the ignition, the rotor should be properly phased to the distributor cap as explained in the supplied Tech Bulletin on Rotor Phasing.

## TIMING THE IGNITION SYSTEM

The timing can be adjusted by sliding the pickup holder assembly up or down in the bracket slot. To retard the timing, move the pickup holder assembly in the direction that the crank trigger wheel rotates. To advance the timing, move the pickup holder assembly in the opposite direction of the trigger wheel rotation (Figure 2). Check the air-gap whenever the timing is changed.

**Note:** Do not attempt to adjust the timing while the engine is running.

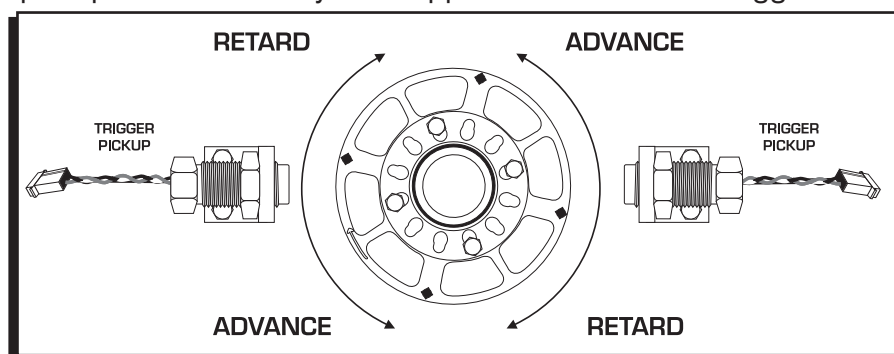

Figure 2 Adjusting the Timing.

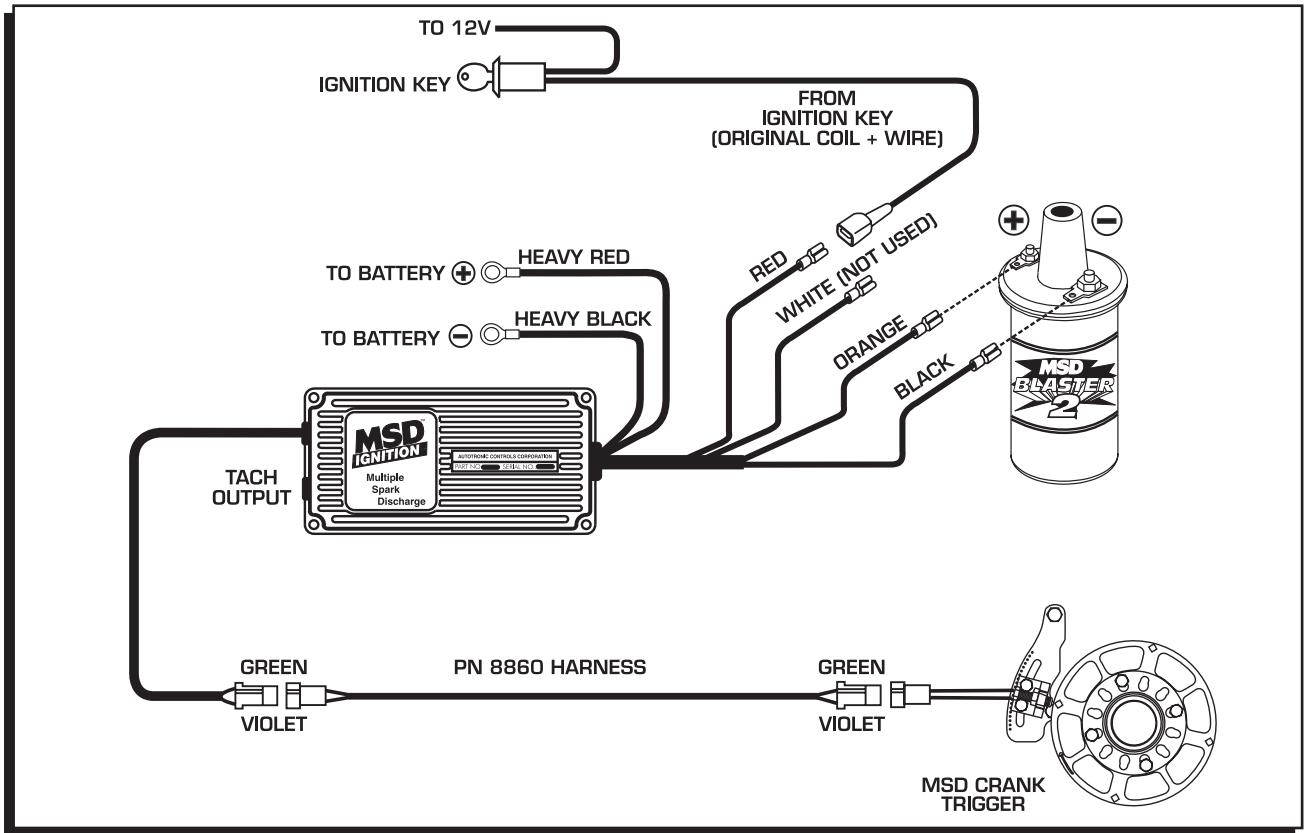

Figure 3 Wiring to an MSD 6AL Ignition Control.

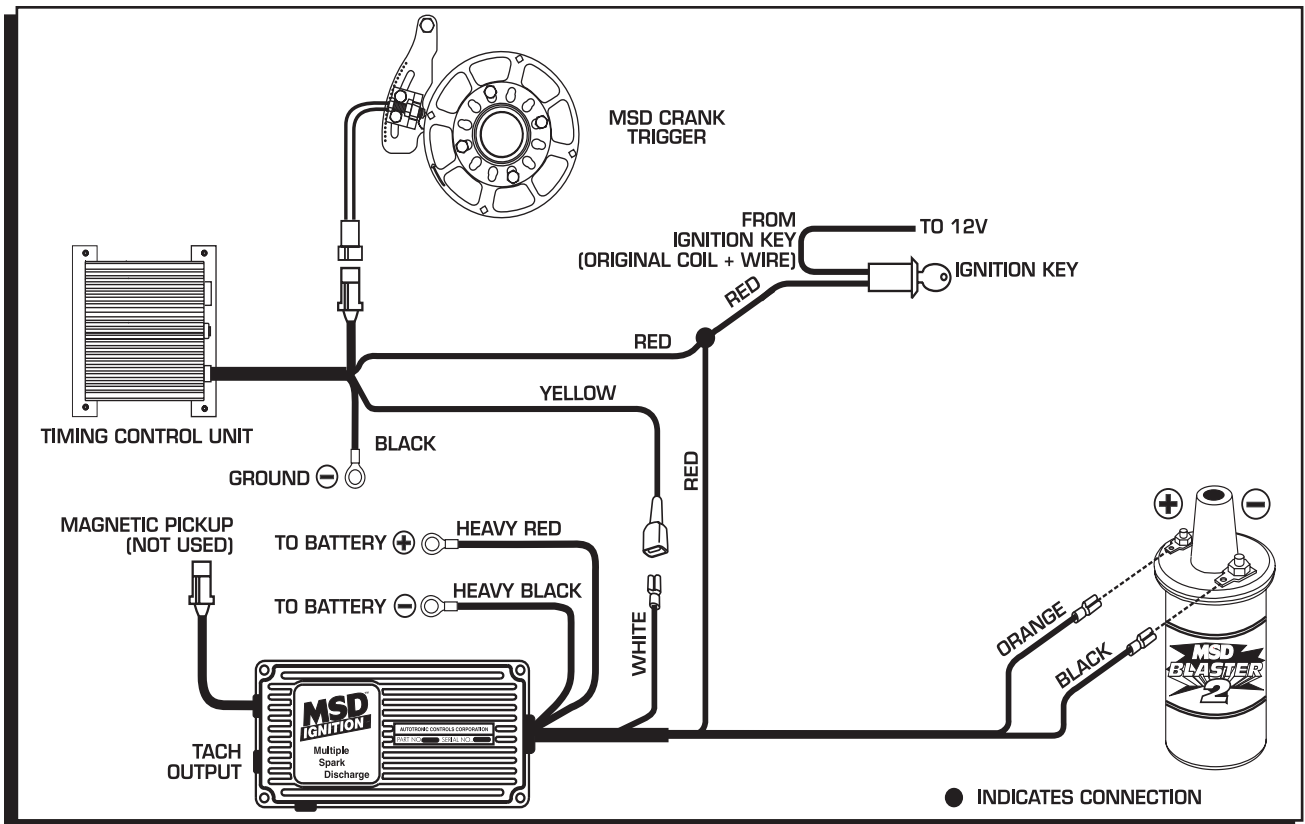

Figure 4 Wiring to an MSD 6AL Ignition and Timing Control.

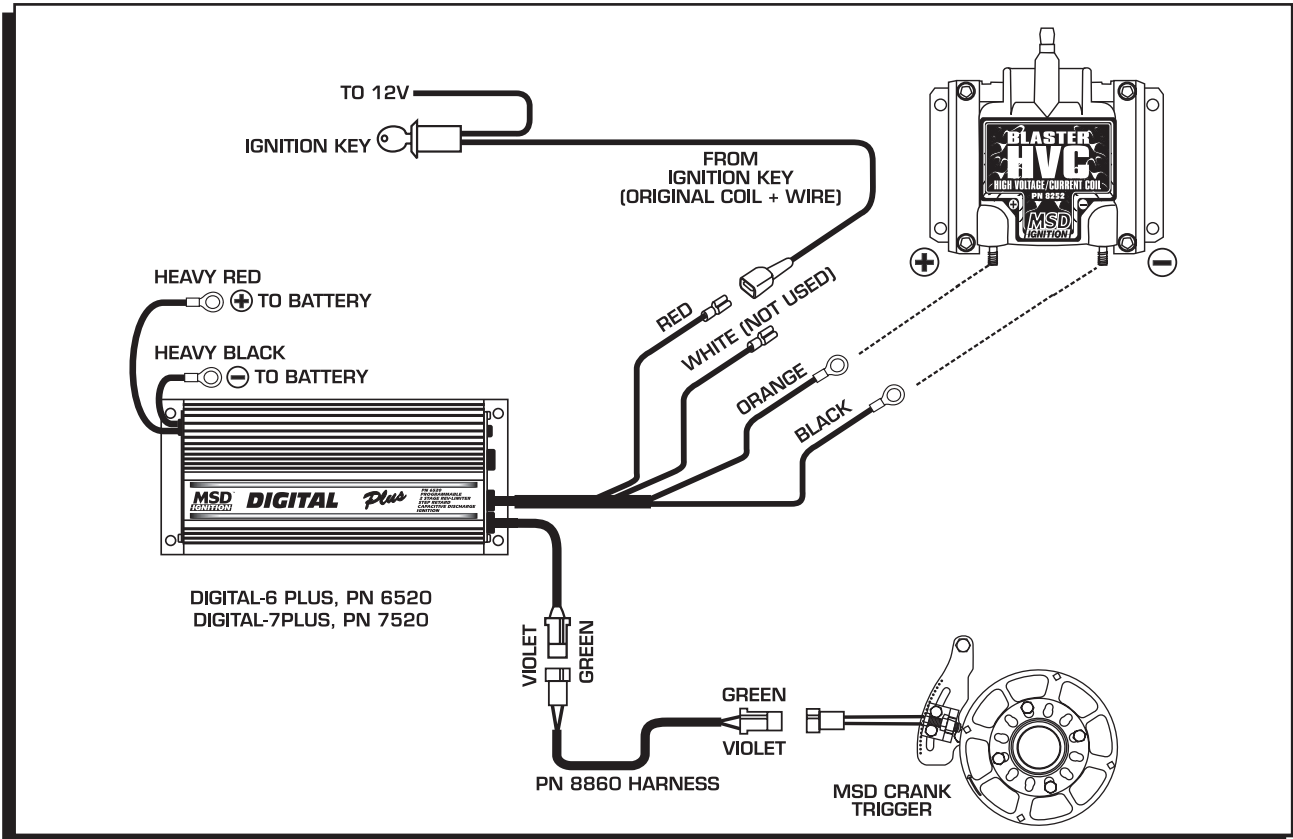

Figure 5 Wiring to an MSD Digital-6 Plus or Digital-7 Plus Ignition Control.

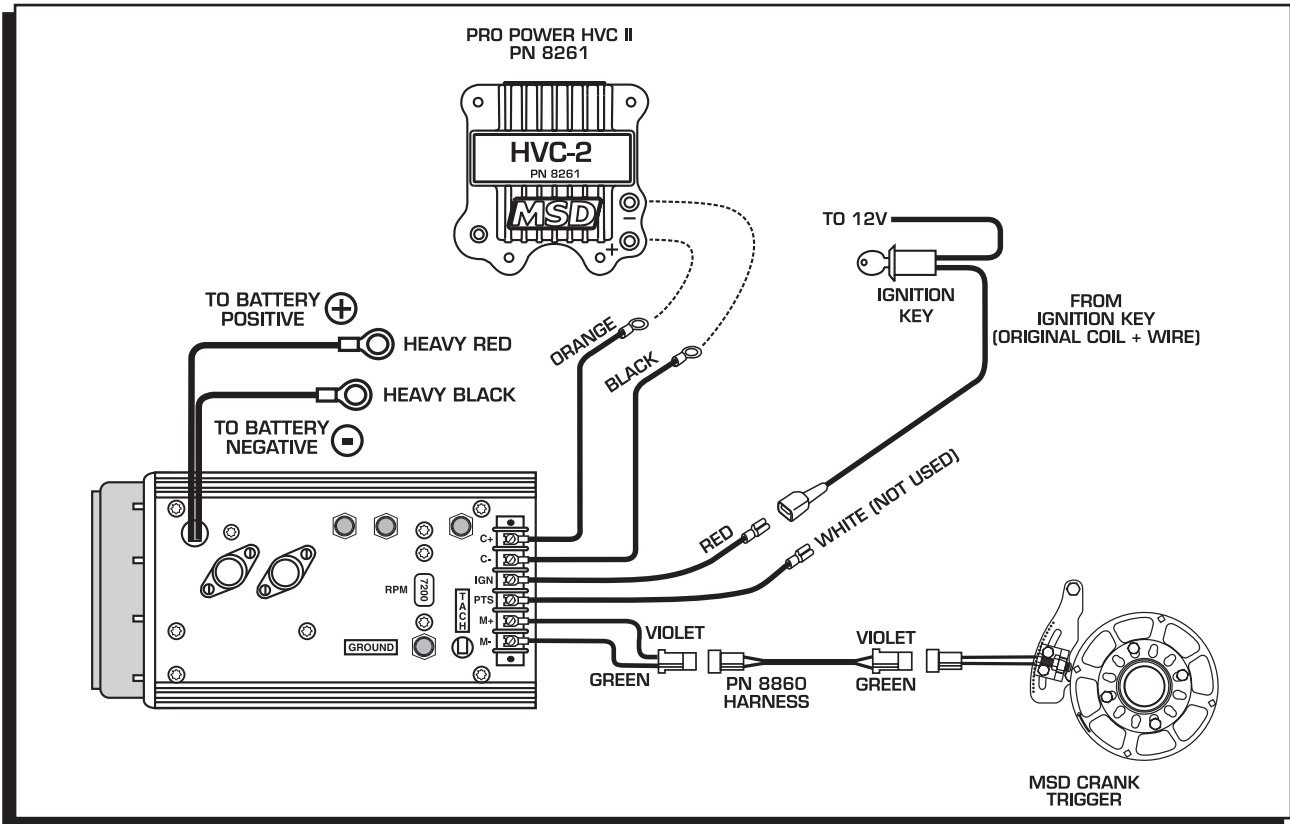

Figure 6 Wiring to an MSD 7AL-2 Ignition Control.

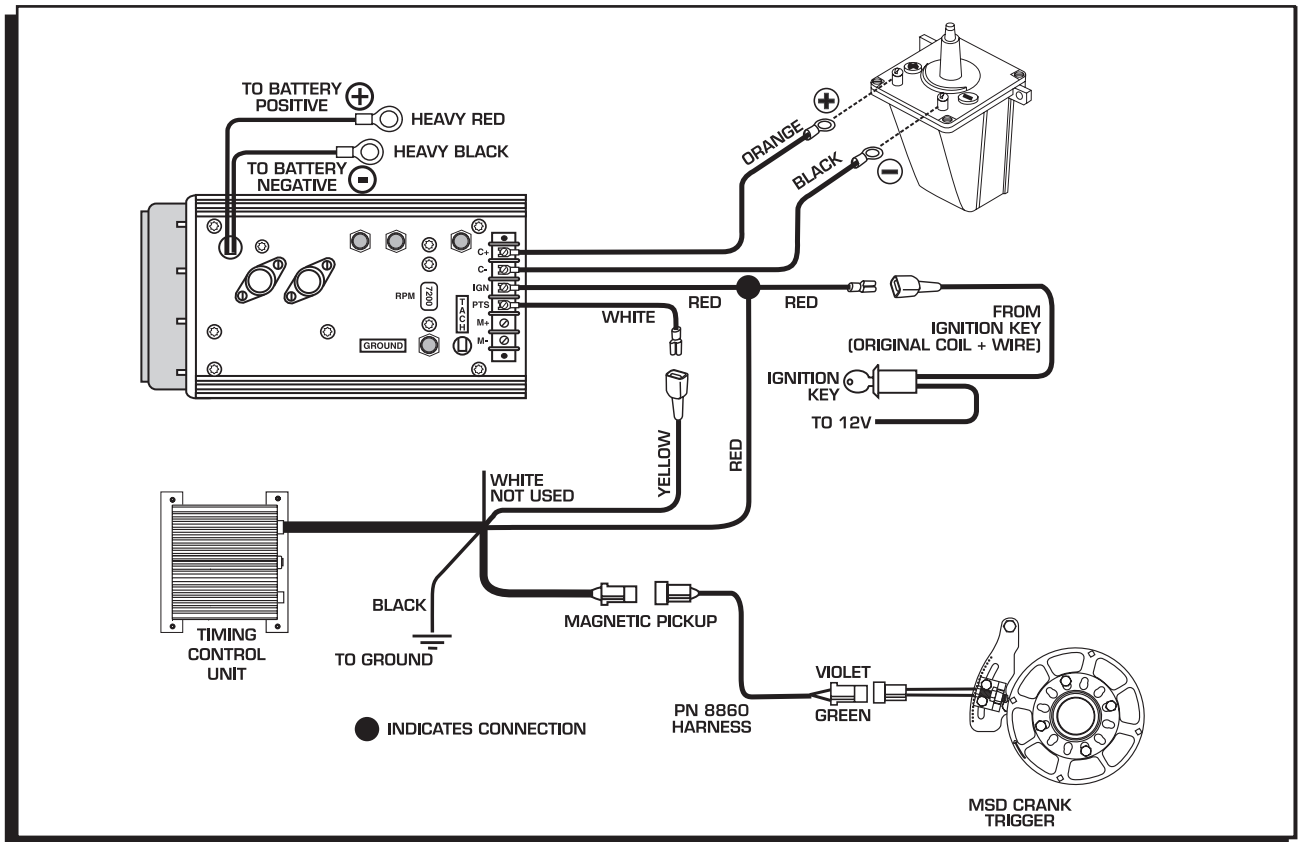

Figure 7 Wiring to an MSD 7AL-2 Ignition and Timing Control.

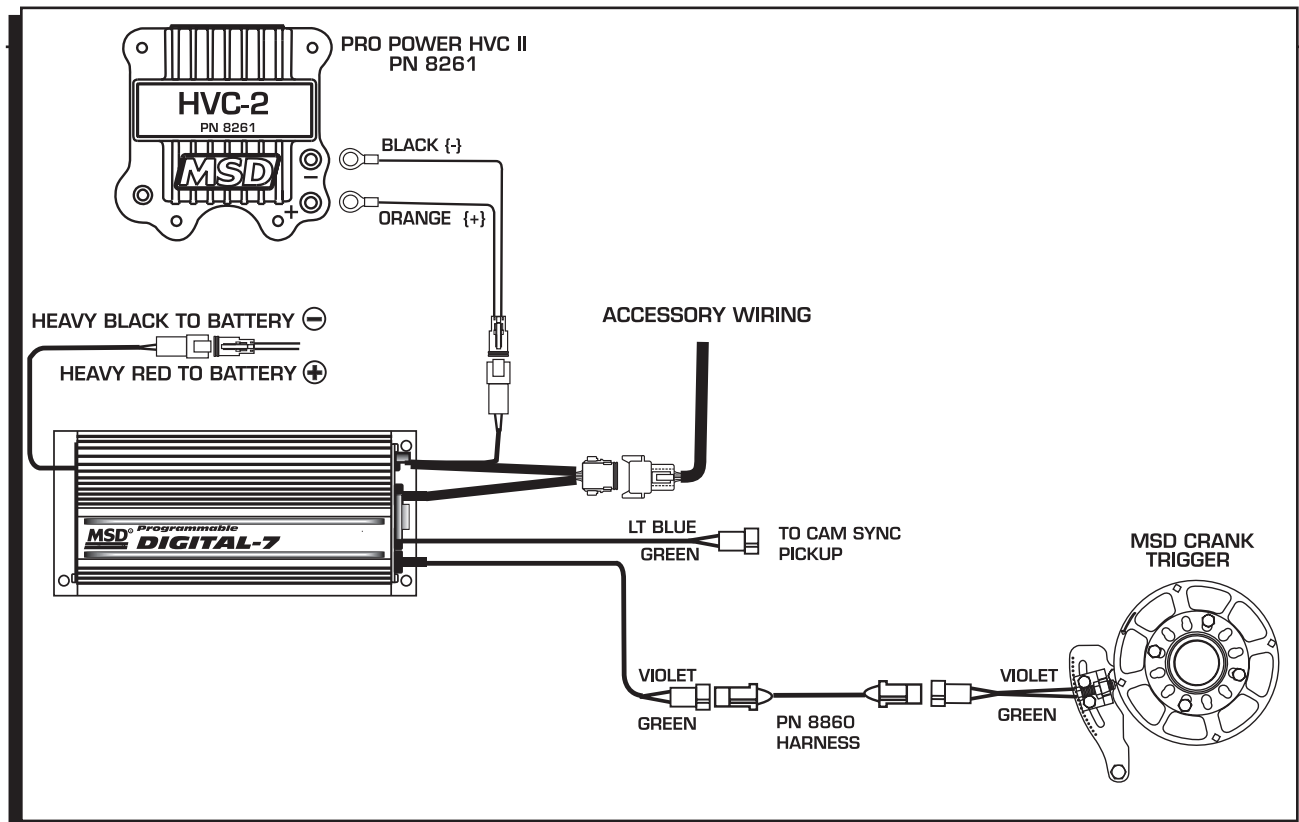

Figure 8 Wiring to an MSD Programmable Digital-7 Series Ignition Control.

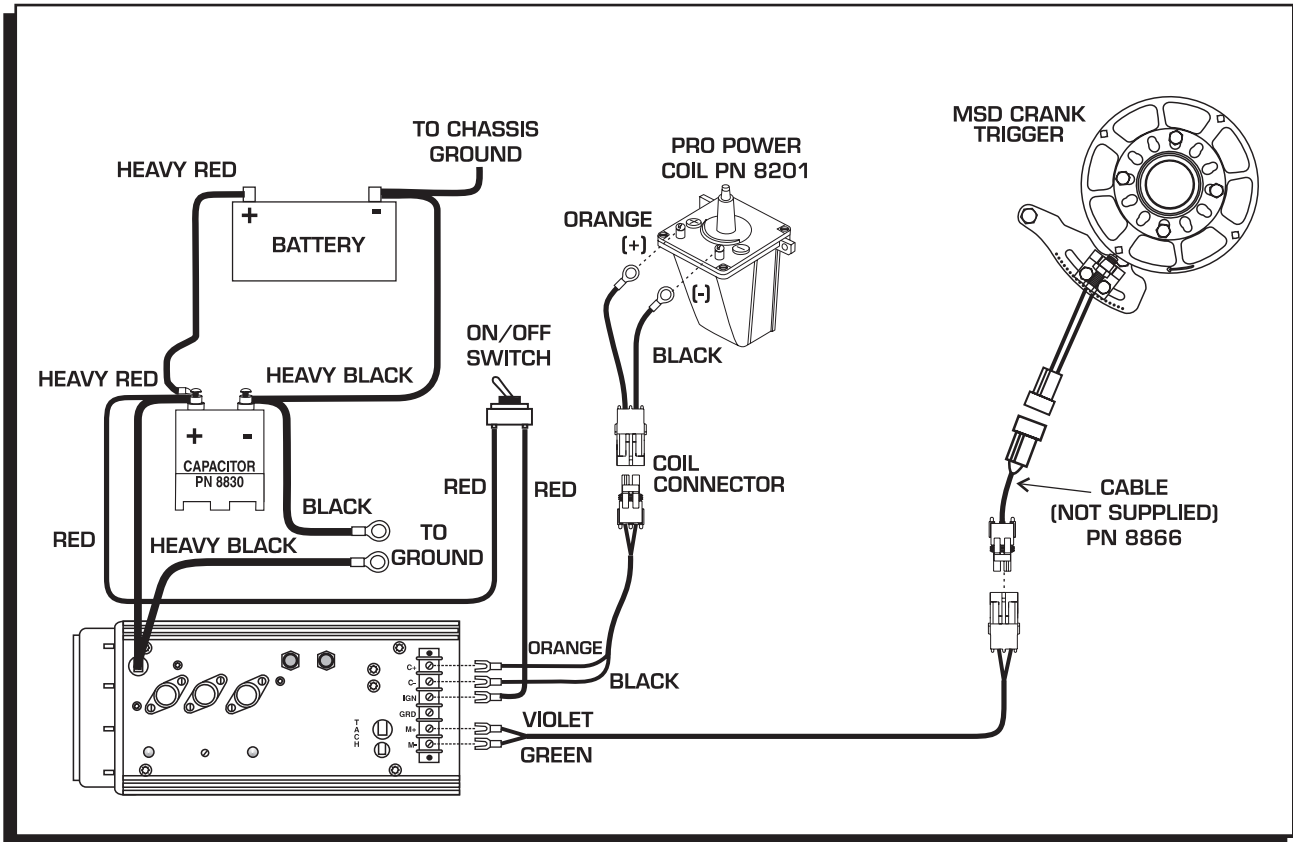

Figure 9 Wiring to an MSD 8 Ignition Control.

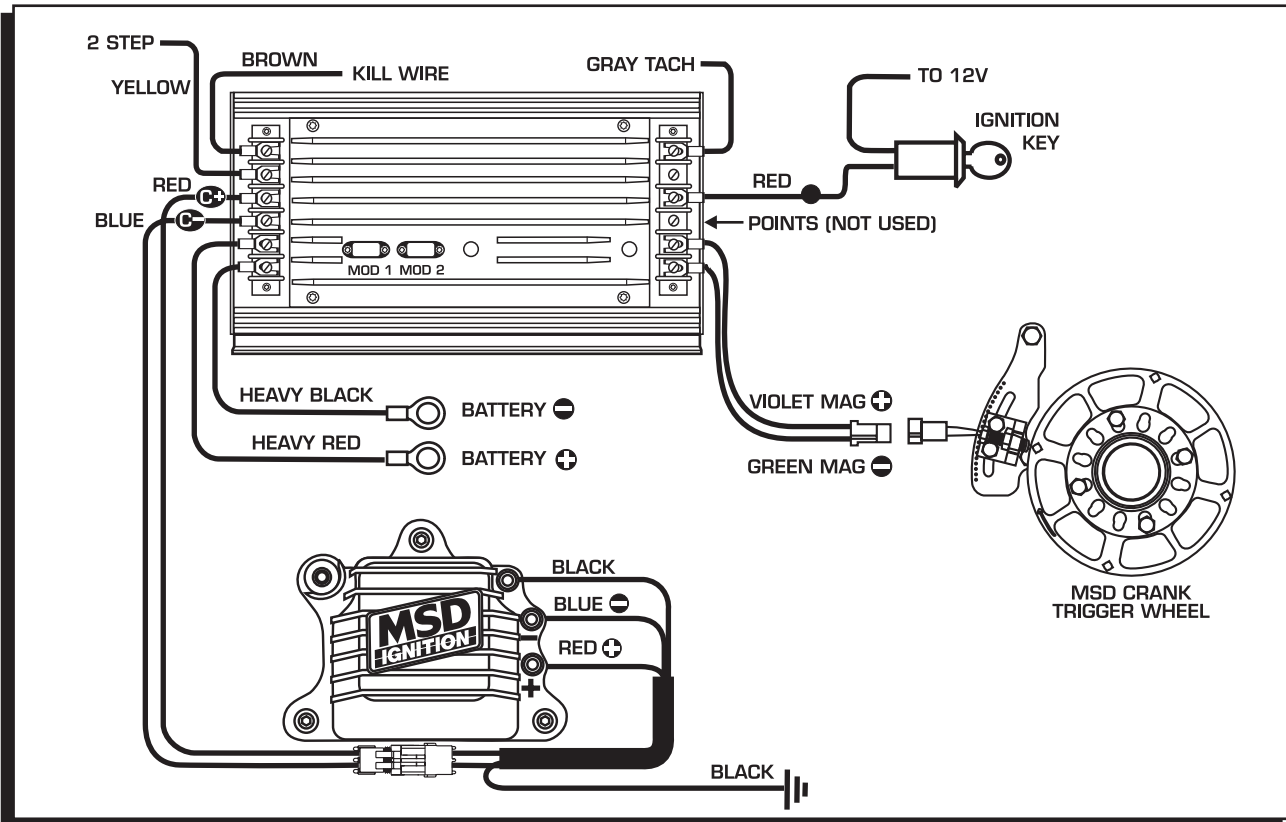

Figure 10 Wiring to an MSD 10 PLUS Ignition.

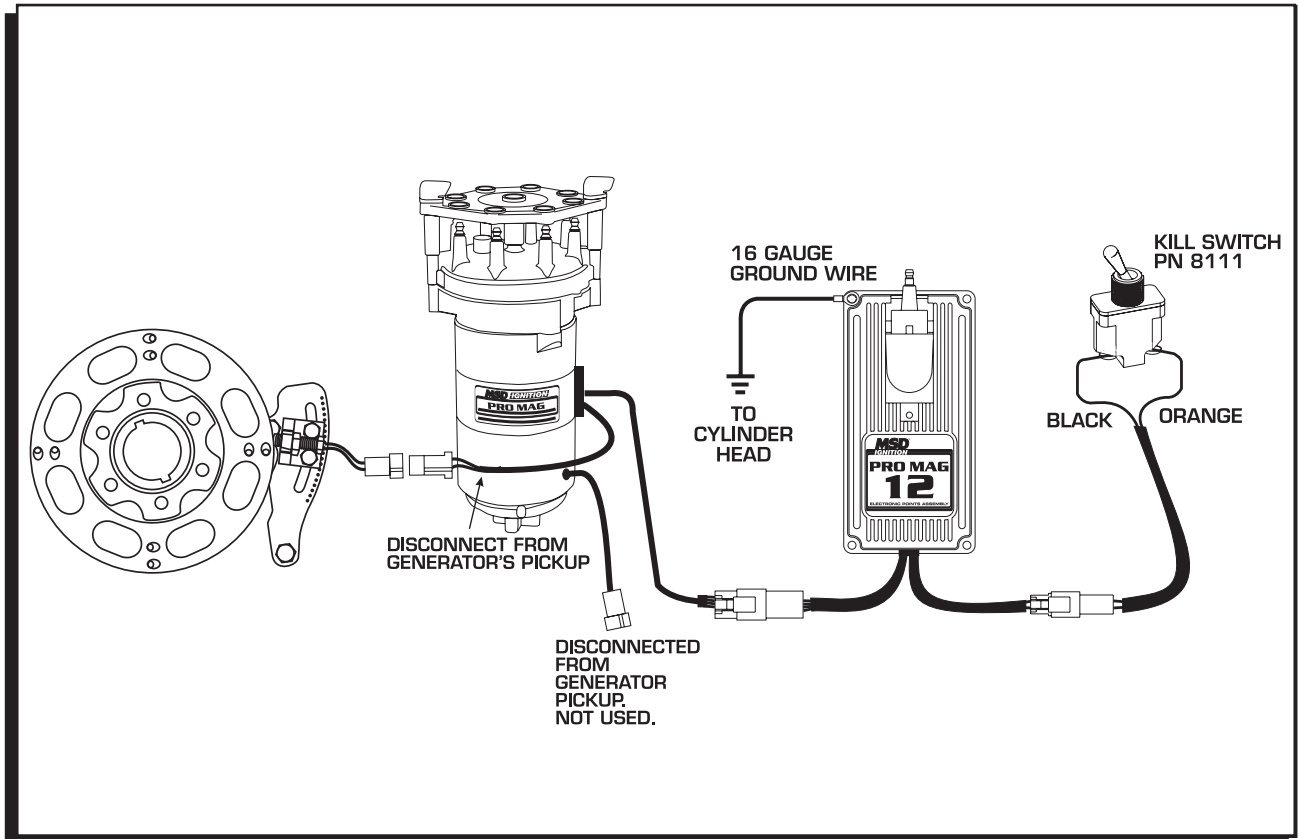

Figure 11 Wiring to an MSD Pro Mag 12.