

INSTALLATION INSTRUCTIONS

Atomic AirForce Intake Manifold for

LS7, 2006-2013 Corvette and 2014 Z28 Camaro - PN 2701

LS2, 2005-2007 Corvette and CTS-V, 2005-2006 GTO and SSR - PN 2702

**LS1/6*, 1997-2004 Corvette, 1998-2002 Camaro/Firebird, 2004-2005 CTS-V,
2004 Pontiac GTO, PN 2702***

ONLINE PRODUCT REGISTRATION: Register your MSD product online. Registering your product will help if there is ever a warranty issue with your product and helps the MSD R&D team create new products that you ask for!

WARNING: When installing the Atomic AirForce Intake Manifold disconnect the battery cables. When disconnecting, always remove the negative cable first and install it last.

Note: CARB Approval is currently pending.

Parts Included:

1 - Intake Manifold Assembly

- 1 - Plenum Seal¹
- 4 - M6x1.0x30mm Socket Head Cap Screw¹
- 4 - ID6.4 xOD17x3mm Thick Flat Washer¹
- 3 - Plenum Post Seals¹
- 6 - ID8.4 xOD20x2mm Thick Flat Washer¹
- 6 - M6x1.0 w/8mm x 8mm Shoulder¹
- 1 - Vacuum Cap, ID5.9mm x 12.7mm L¹

¹ - Pre-Installed

1 - Seal Kit

- 10 - Silicone O-ring, 3/32 W, -108
- 8 - Intake Port Seals
- 1 - Throttle Body Seal

1 - Fastener Kit

- 10 - M6x1.0x30mm Socket Head Cap Screw (Short Pinch Bolt)
- 18 - ID6.4xOD17x3mm Thick Flat Washer
- 2 - M6x1.0x45mm Socket Head Cap Screw (Long Pinch Bolt)
- 10 - ID6.4xOD12.5x1.4mm Thick Flat Washer
- 3 - 14mm Torx-Head Plastite Screw (Cable Bracket, EGR)
- 1 - M6x1.0 Square Nut (Throttle Cable Bracket)
- 10 - M6x1.0x<> Socket Head Cap Screw (Cylinder Head)
 - <> = 100mm for 2701
 - <> = 110mm for 2702
- 4 - M6x1.0x40mm Socket Head Cap Screw (Electronic Throttle Body only)

Parts or Tools Required:

Quick Connect Removal Tool for Fuel Lines
Drill and 1/8" bit
O-Ring Assembly Lube
Injector O-Rings (if using new injectors)
Blue Loctite®

***When installing on an LS1/6 engine:**

PN 2709 Adapter is required for use with OEM 3-bolt Throttle Body
There may be interference with original water pump.
See Page 8 for more details.

WARNING

Installation of this product requires detailed knowledge of automotive systems and repair procedures. Installation of fuel system parts and any modifications must be carried out by a qualified automotive technician. Installation of fuel system parts requires handling of gasoline. Ensure that work is performed in a well ventilated area with an approved fire extinguisher nearby. Extinguish all open flames, prohibit smoking and eliminate all sources of ignition in the area of the vehicle before beginning the installation. When working with fuel systems, eye goggles and other safety apparel should be worn to protect against debris and sprayed gasoline. The finished work must be thoroughly checked to ensure there are no fuel leaks.

Thank you for choosing the MSD Atomic AirForce intake manifold. We've taken great care during the development of this manifold to ensure you are getting the most power possible out of your LS engine.

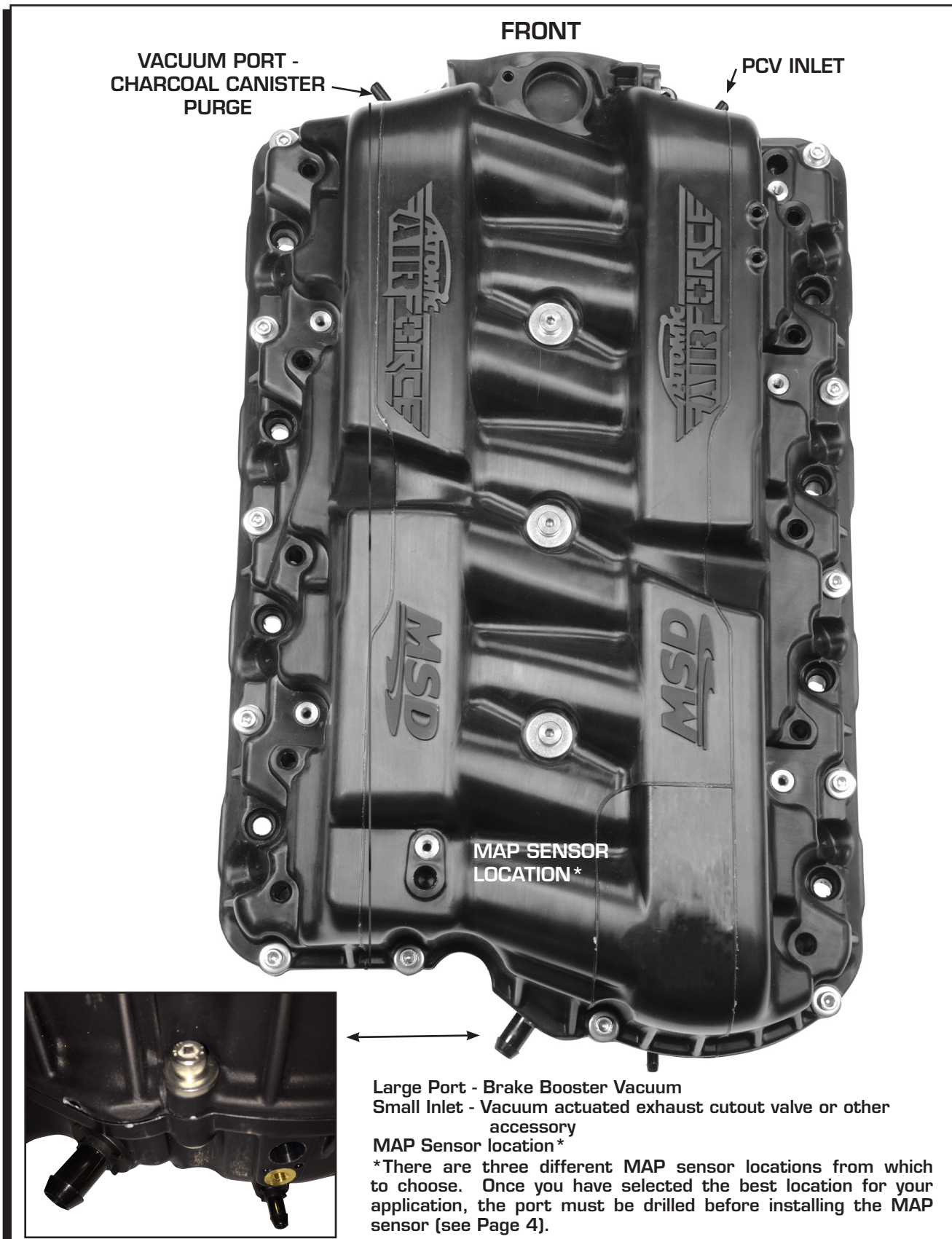

Figure 1 Rear Vacuum Ports and MAP Sensor Mounting Location (1 of 3 shown).

Note: If you are installing the Atomic AirForce on a stock vehicle, it is recommended to have the Service Manual for that vehicle handy to follow any specific procedures for your exact application.

REMOVAL

Remove the engine cover assembly and, before disassembly, clean the entire intake area with compressed air to remove any dirt or debris that could fall into the engine or interfere with the installation.

1. Locate the Schrader valve at the front of the fuel rail (Figure 2). Wrap the valve and surrounding area with a towel and press the valve down to release any fuel pressure. Once the fuel pressure is released, disconnect the fuel line from the fuel rail with the release tool.
2. Disconnect the TPS, MAP sensor and MAF sensor connections from the front of the intake assembly (Figure 3).
3. Remove the intake duct tubing from the throttle body.
4. Remove the four bolts retaining the throttle body, pull the unit off and set aside.
5. Remove and note the use and position of any vacuum lines and PCV hoses (Figure 4).
6. Disconnect the eight injectors by pressing the small wire retainer and pulling the connector off. It may also be necessary to disconnect the large coil connector on both banks of the engine. Pull the wiring and connectors aside so the intake can be lifted off the engine.
7. Remove the 10 intake bolts using an 8mm socket and wrench. It may be necessary to disconnect the brake booster vacuum line and any vacuum operated accessory hoses in the rear of the manifold prior to lifting the intake off the engine. Use care not to let anything fall into the engine and cover the intake ports (Figure 5).
8. Set the intake aside and clean any material away from the top of the cylinder head ports to prepare for the installation.



Figure 2 Schrader Valve Location.

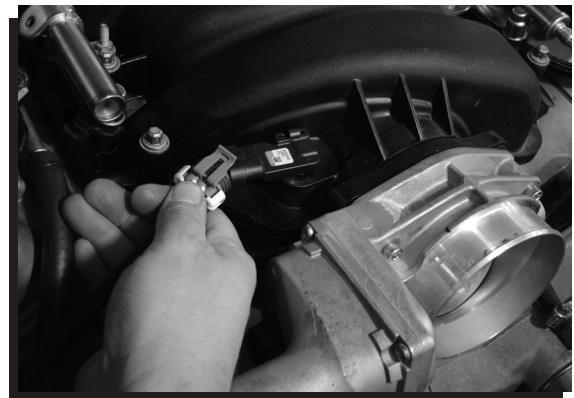

Figure 3 Disconnect Sensors and Remove the Throttle Body

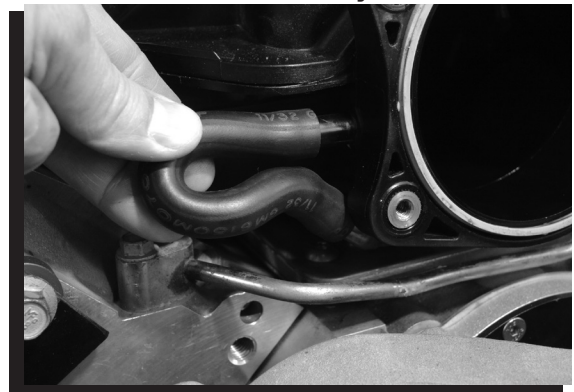

Figure 4 Mark and Remove Vacuum Lines.



Figure 5 Removing the Intake Retainers.

9. If using the OEM fuel rail assembly and injectors, remove the four retaining bolts from the intake. Lift the assembly taking note that each injector stays connected to the fuel rail and each O-ring is in place on the injector.

INSTALLATION

PREPARING THE AIRFORCE INTAKE

Your AirForce intake is supplied with four pinch bolts and the top stanchion bolts installed. This is so you can remove the top of the manifold and drill the appropriate MAP sensor location. You'll also notice several different vacuum ports on the intake. See Figure 1 for explanations and common uses.

MAP Sensor Location: The majority of applications use a MAP sensor in the front passenger side of the intake, but there are also two other locations available depending on your application. If possible, refer to the OE intake for the proper position (See Figure 1 on page 2 for MAP locations.) and if you're building a custom application, refer to the location of the MAP connector on the engine wiring harness.

Use an 1/8" bit to drill the MAP sensor hole. A new screw and washer (M6x1.0x30mm and ID6.4xOD12x1.4mm Thick) are supplied to mount the sensor. After drilling, clean the area thoroughly with compressed air to remove any chips or debris.

Note: The existing MAP ports accommodate sensors with the orange multi-rib sealing grommet. MAP sensors equipped with an O-ring will require careful enlargement of the chosen port with a 15/32 drill bit.

INJECTOR TETHER

This unique sealing feature serves the purpose of sealing tuning pulses only at the injector interface in the runner. This does not perform the function of sealing the intake to the outside world so if it is missed it only represents a possible loss of tuning strength and performance. It is tethered to the perimeter seal to ensure that if it is not installed properly it is not loose inside the intake manifold.

ASSEMBLY

With the MAP sensor installed, the intake can be assembled. Locate the supplied eight M6x1.0x30mm and two M6x1.0x45mm socket head cap screws and ID6.4xOD17x3mm thick washers. With everything clean and free of debris, confirm that the seal is in position all the way around the intake assembly, the injector tethers are in position and the three top stanchions have their seals in place.

1. Position the upper manifold to the lower assembly. Apply Blue Loctite® thread locker to the 14 fasteners. Make sure the seal and two assemblies are aligned properly and loosely install the 14 pinch bolts and washers and the three stanchion bolts/washers. Note that two longer M6x1.0x45mm bolts go in the bolt holes on the sides of the throttle body opening, and they must be fitted with the ID6.4xOD12.5x1.4mm Thick flat washers.
2. Begin the torque process starting with the three top stanchion shoulder bolts in the order shown in Figure 8. Use two passes on the three shoulder bolts to achieve 75 in-lb.
3. Torque the 14 perimeter pinch bolts in two stages to achieve 75 in-lb. Follow the sequence shown in Figure 8 on page 5. Re-confirm the three stanchion shoulder bolts torque values as well.



Figure 6 Drilling the MAP Sensor Hole.

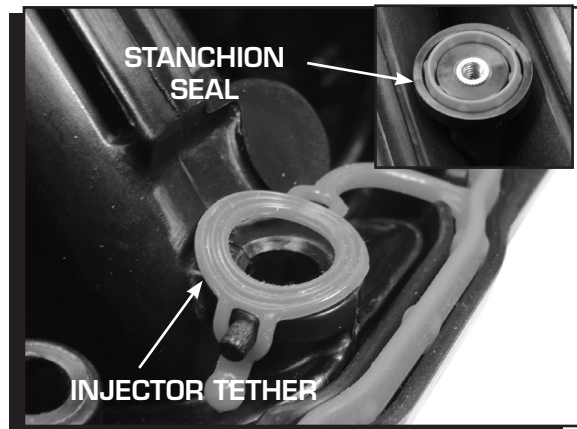

Figure 7 Intake Seals and Injector Tether.

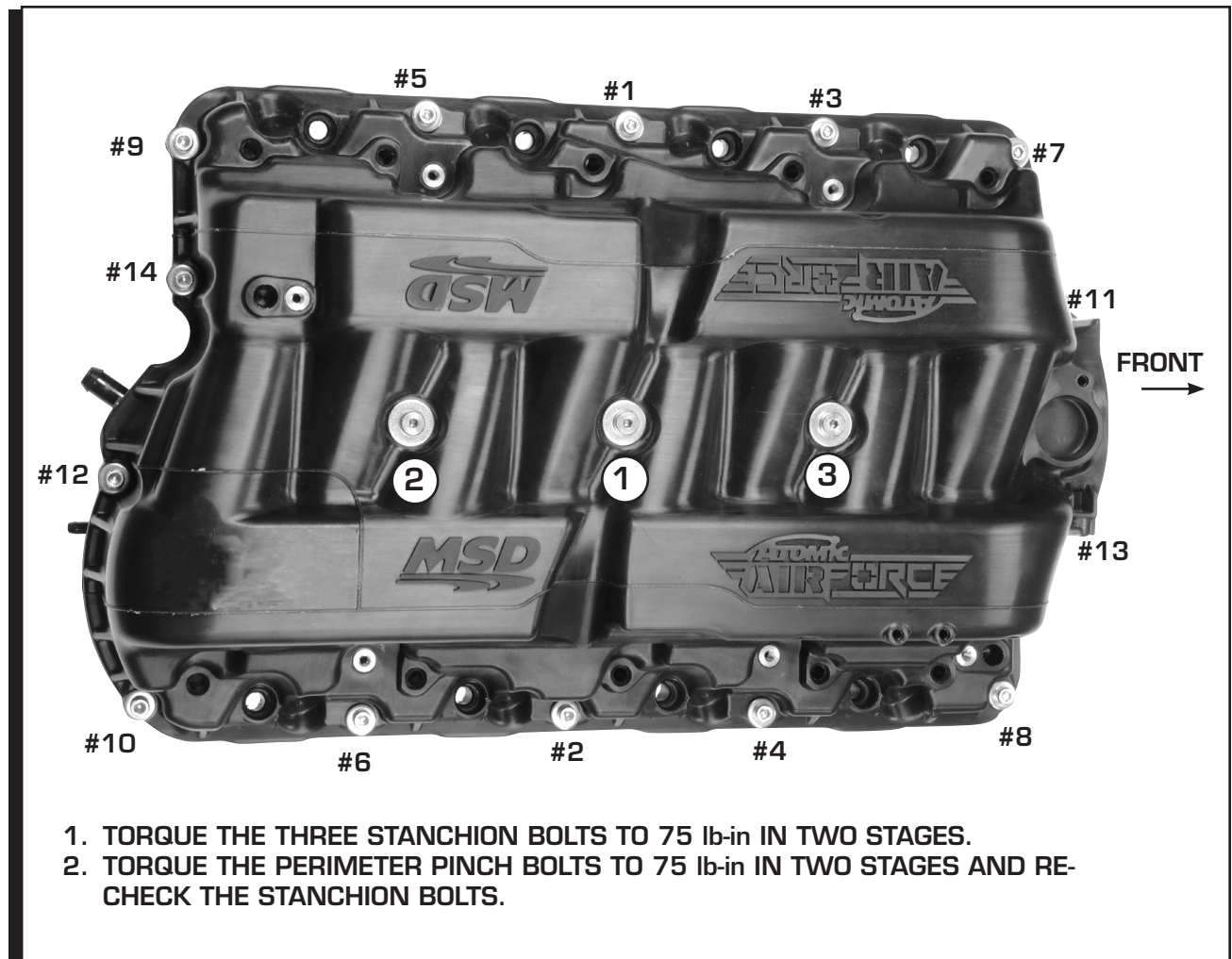

Figure 8 Intake Upper Shell - Torque Pattern.

FUEL RAIL INSTALLATION

If using the original fuel rail assembly, inspect the O-rings on each injector. Make sure they are in place and have no cracks, tears or abrasions. It is recommended to put a light coating of O-ring assembly lube on each one to aid in seating and sealing in the new intake. Also ensure that each injector is secured in the fuel rail with the required retaining clip.

Lower the fuel rail assembly over the intake making sure each injector seats into its corresponding pocket. Once aligned, each bank can be carefully pressed in to seat. The rail assembly will fit down onto the intake with the retaining tabs nearly making contact with the top of the intake. Utilize the fasteners that came with your fuel rail to secure the rails to the intake manifold. If you choose to source alternate fasteners, the recommended screw size is M6x1.0x16mm.

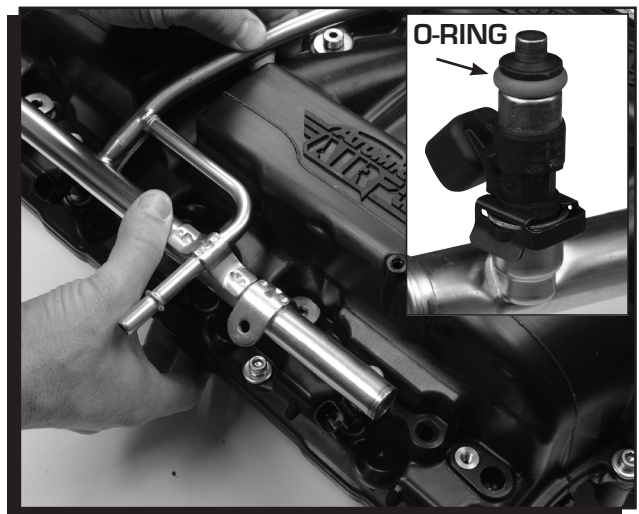

Figure 9 Fuel Injector and Rail Installation.

A production fuel rail may be installed with the feed line on either side of the engine.

INSTALLATION TO THE ENGINE

With the MAP sensor location drilled and the fuel rail assembly installed, it is time to install the AirForce intake on the engine. To prepare for installation:

- Locate the 10 new M6x1.0x<> SHCS and ID6.4xOD17x3mm Thick washers for assembly.
 - <> = 100mm for 2701
 - <> = 110mm for 2702
 - Install washers onto each screw and, then install a 2-108 O-ring under each washer.
 - Apply Blue Loctite® thread locker to the fasteners.
 - Identify which vacuum ports will be used in your application. Cover and seal the ports that will not be used.
 - Ensure that each port seal is installed properly around the runner port and that the heads are clean. The port seals have a tab to help orient the seal correctly.
1. With everything clean, lower the intake manifold onto the engine. Use caution not to move the intake around while in contact with the heads to prevent dislodging a seal. It may be easier to connect the brake booster vacuum hose (and the vacuum actuated exhaust cutout valve hose if used) before bolting the intake to the engine.
 2. When installing on a Corvette or Camaro, use the O-rings to hold the rear bolts up to prevent them from catching on the head ports. It will help to tip the front on the intake up and carefully slide it rearward into position.
 3. Once in place, start each of the intake bolts.
 4. Tighten the 10 Socket Head Cap Screws (SHCS) using the sequence shown in Figure 11. Use multiple passes (a minimum of four are recommended) to achieve a final torque of 89 lb-in.

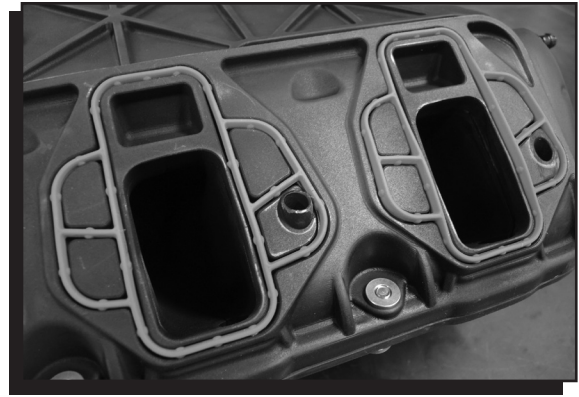

Figure 10 Port Seals.

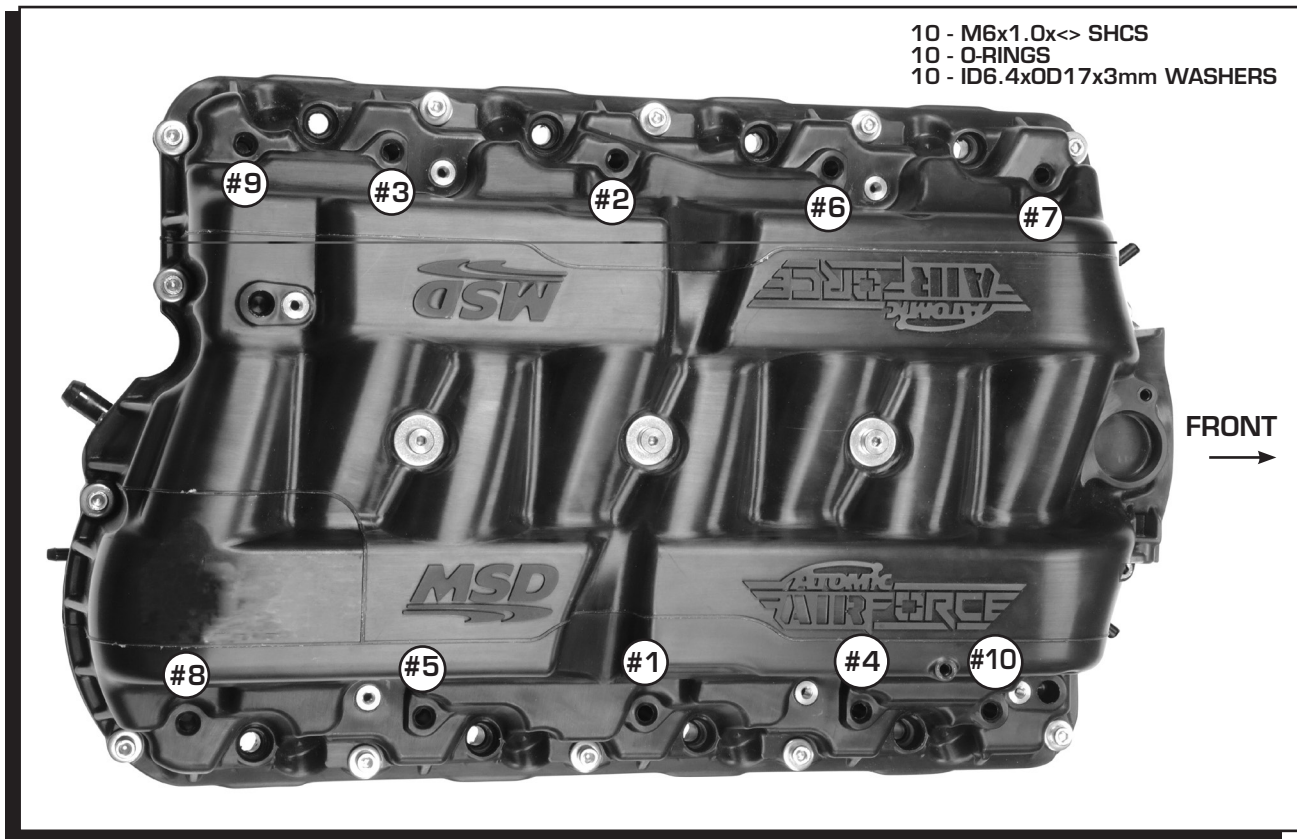

Figure 11 Intake-to-Cylinder Head Torque Sequence.

CAUTION: Multiple passes are required to ensure that the intake port seals have fully compressed and seated within their retention grooves. Failure to ensure a stable final torque value may result in subsequent vacuum leaks or other driveability problems. **DO NOT** overtighten the fasteners, as this can damage the intake assembly and/or the threads in the cylinder heads.



Figure 12 Installing the Throttle Body.

If re-installing the OEM/aftermarket electronic throttle body, use the four supplied M6x1.0x40mm bolts and washers (ID6.4xOD12.5x1.4mm Thick). Install the supplied throttle body seal, and then torque the bolts to 89 in-lb. Install the fresh air inlet ducting.

Note: If using a mechanical throttle body (cable operated), use the fasteners supplied by the throttle body manufacturer. M6x1.0x25mm bolts are recommended. Check to make sure the bolts do not contact the lower manifold shell, or bottom in their holes as they are being tightened.

CAUTION: Do NOT use the OEM electronic throttle body retaining bolts. The OEM bolts will contact the lower manifold housing and result in irreparable damage.

6. Connect the coils packs, injectors, IAC, TPS and anything else disconnected.
7. Connect the appropriate connector or hose to the PCV hose barb and purge canister quick connect. Ensure that the unused ports are sealed if using in a custom application.
8. Connect the fuel rail supply line.
9. Connect the battery and cycle the key to the run position (DO NOT start the engine) several times to pressurize the fuel line assembly and check for leaks. With no leaks present, start the engine and inspect for vacuum leaks and ensure proper idle stability.

INSTALLATION NOTES FOR LS1/LS6 ENGINES

- The Atomic AirForce manifold uses a 4-bolt throttle body mount. To use the OEM LS1/6 3-bolt throttle body, MSD offers an adapter, PN 2709.
- OEM fuel rails cannot be used on the LS1/6 Atomic AirForce manifold. MSD recommends using fuel rails designed for LS2/3 applications.

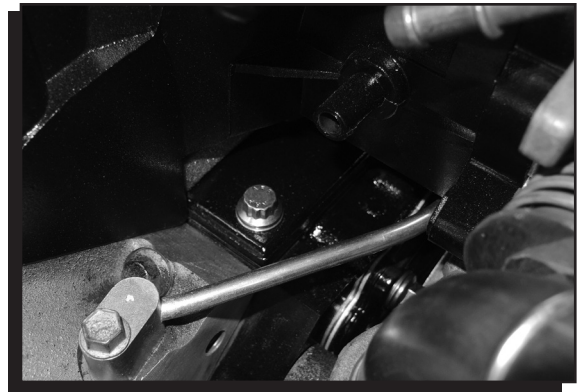

Figure 13 Front Water Vent Line.

- Note:** Fuel rail spacers and oversized lower injector O-rings can be used to install LS1 injectors with an LS2-style rail (Use MSD PN 2705 - LS1 Injector Adapter Kit).
- The OEM 4 corner water vent line that runs under the intake cannot be used. MSD recommends using a newer water vent line that connects the front two ports on the heads (Figure 13). The two rear ports can be plugged.
 - Some early Corvettes applications equipped with an AIR System will require the AIR tube to be modified around the rear flange of the Atomic AirForce manifold.
 - For mechanical throttle bodies, a throttle cable bracket will be required.

MSD INSTALLATION INSTRUCTIONS

WATER PUMP INTERFERENCE ON LS1/LS6 ENGINES

On LS1/6 engines equipped with an original water pump, the bolted back cover will interfere with the Atomic AirForce throttle body flange (Figure 14).

There are two options available:

Carefully grind the bolt head and bolt boss to achieve the necessary clearance

Install a later-model LS2-style water pump (Such as AC Delco PN 19195105)

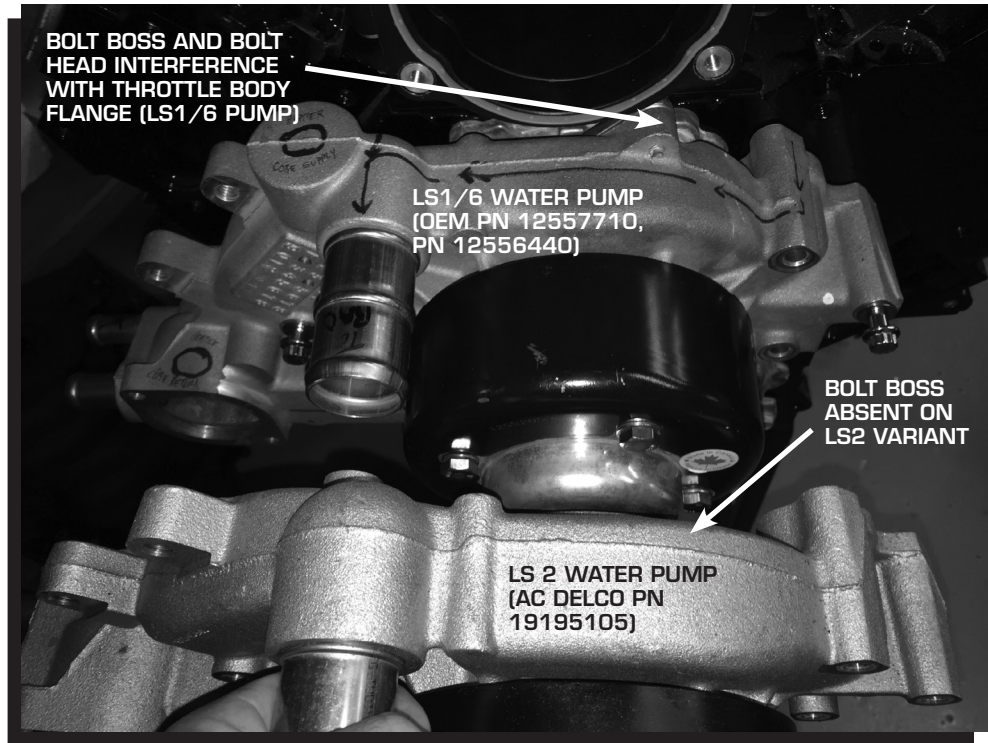

Figure 14 - LS1/6 and LS2 Water Pump Comparison