



Above. Beyond. Always.



# PRODUCT CATALOG

# RUBBER PIN BOX

No more chucking, jerking, bucking, and pushing

Leave rough towing behind with MORryde's revolutionary Pin Box System. Its advanced rubber shear spring works to absorb towing shock for more comfortable, stress-free travel.



## MORryde PIN BOX SYSTEM

Eliminate your fifth wheel's back-and-forth chucking with MORryde's rubber pin box.

- Jerk-free starts and stops
- 3" fore/aft travel and 1 1/2" side to side travel
- Maintenance-free
- Greatly reduced back-and-forth chucking and jerking
- Cushioned sensation over uneven road conditions
- Smoother, more comfortable in-cab ride

The MORryde Pin Box System can be ordered from a dealer in your area, and installation couldn't be easier. Using the existing bolt holes, the MORryde Pin Box System replaces the stock product in less than an hour.

United States Patent 6,986,524

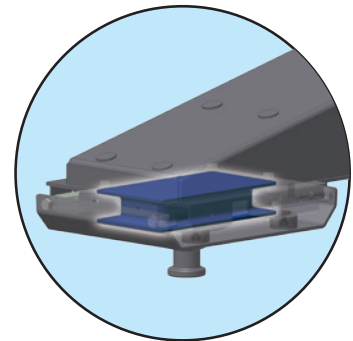

UNIQUE RUBBER SHEAR SPRING  
ABSORBS SHOCK

### Rubber Pin Box System

Part Number - See Ordering Guide

### Adaptor for Pull Rite Super Glide

Part Number - RPB77-001

### Skid Pad for use with Gooseneck Adaptors\*

Part Number - RPB77-006

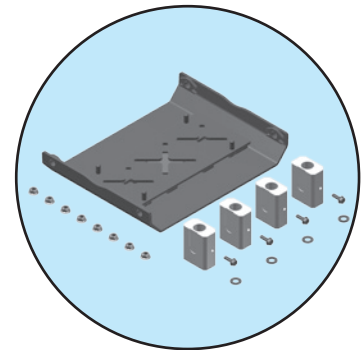

HEAVY DUTY SKID PLATE WITH HARDWARE FOR USE WITH A MORRYDE PIN BOX WHEN CONNECTING TO A GOOSENECK ADAPTOR. ONE SIZE FITS ALL MORRYDE PIN BOX MODELS.

\* Gooseneck sold separately.  
Contact your manufacturer about compatibility.

# PIN BOX FIT CHART

CROSS-REFERENCE GUIDE		* ORDER ACCORDING TO GVWR OF THE TRAILER (NOT THE GVW OF THE PIN BOX)				MORryde Pin Box Rating
MFG	MODEL #	11,500 or less	11,501 - 14,000	14,001 - 18,000	18,001 & over	
Lippert	1621, SHD-TA			RPB72-1621SHD-TA-05	RPB72-1621SHD-TA-06	24k
Lippert	1621, HD, SHD	RPB72-1621HD-03	RPB72-1621HD-04	RPB72-1621HD-05	RPB72-1621SHD-06	23k
Lippert	1716	RPB72-1716-03	RPB72-1716-04	RPB72-1716-05		18k
Lippert	1116	RPB72-1116-03	RPB72-1116-04	RPB72-1116-05	RPB72-1116-06	19k
Lippert	0719	RPB72-0719-03	RPB72-0719-04	RPB72-0719-05		15.5k
Lippert	0516	RPB72-316-03	RPB72-316-04	RPB72-316-05	RPB72-316-06	CSA at 18k
Lippert	0115	RPB72-0115-03	RPB72-0115-04	RPB72-0115-05		16.4k
Leland	7920, 7921	RPB72-221002300-03	RPB72-221002300-04	RPB72-221002300-05		19k
Leland	7930	RPB72-7930-03				10k
Leland	7910	RPB72-7910-03	RPB72-7910-04	RPB72-7910-05		18k
Leland	7900	RPB72-7900-03	RPB72-7900-04	RPB72-7900-05		15k
Fabex	500	RPB72-500-03	RPB72-500-04	RPB72-500-05		15k
Fabex	503	RPB72-503-03	RPB72-503-04	RPB72-503-05		15k
Fabex	665	RPB72-665-03	RPB72-665-04	RPB72-665-05		15k
Fabex	765	RPB72-765-03	RPB72-765-04	RPB72-765-05	RPB72-765-06	21k
Fabex	770	RPB72-770-03	RPB72-770-04	RPB72-770-05	RPB72-770-06	21k
Fabex	520	RPB72-520-03	RPB72-520-04	RPB72-520-05		15k
Fabex	663	RPB72-663-03	RPB72-663-04	RPB72-663-05		15k
Fabex	730	RPB72-730-03	RPB72-730-04	RPB72-730-05	RPB72-730-06	21k
Fabex	300,314,316	RPB72-316-03	RPB72-316-04	RPB72-316-05	RPB72-316-06	CSA at 18k
Fabex	315	RPB72-315-03	RPB72-315-04	RPB72-315-05	RPB72-315-06	N/A
Fabex	330	RPB72-330-03	RPB72-330-04			13k
Fabex	560	RPB72-560-03	RPB72-560-04	RPB72-560-05		15k
Fabex	660	RPB72-660-03	RPB72-660-04	RPB72-660-05	RPB72-660-06	24k
Venture	Long	RPB72-VL-03	RPB72-VL-04	RPB72-VL-05		17k
Venture	Med	RPB72-VM-03	RPB72-VM-04	RPB72-VM-05		15k
Youngs Welding	Long	RPB72-YWL-03	RPB72-YWL-04	RPB72-YWL-05	RPB72-YWL-06	19.5k
Youngs Welding	Medium	RPB72-YWM-03	RPB72-YWM-04	RPB72-YWM-05	RPB72-YWM-06	19.5k
Youngs Welding	45 degree	RPB72-YW45-03	RPB72-YW45-04	RPB72-YW45-05		16k
Youngs Welding	6640-1	RPB72-6640-1-03	RPB72-6640-1-04			12k
Youngs Welding	52751	RPB72-52751-03	RPB72-52751-04	RPB72-52751-05	RPB72-52751-06	N/A
Youngs Welding	Short	RPB72-YW0-03	RPB72-YW0-04	RPB72-YW0-05	RPB72-YW0-06	16.4k
RBW	7019	RPB72-7019-03				10k
RBW	7016-2P	RPB72-7016-03	RPB72-7016-04	RPB72-7016-05		15k
RBW	7027	RPB72-7027-03	RPB72-7027-04			12k
Atwood	AB-34 HD	RPB72-AB34-03	RPB72-AB34-04	RPB72-AB34-05	RPB72-AB34-06	N/A
Atwood	AB-72	RPB72-AB72-03	RPB72-AB72-04	RPB72-AB72-05		18k
Dexter	221-0023-00	RPB72-221002300-03	RPB72-221002300-04	RPB72-221002300-05	RPB72-221002300-06	19k
Dexter	221-0031	RPB72-2210031-03	RPB72-2210031-04	RPB72-2210031-05		16k
Dexter	221-0037	RPB72-2210037-03	RPB72-2210037-04	RPB72-2210037-05	RPB72-2210037-06	21k

\*GVWR above are general guides and may not directly correlate to shear spring density

Note: RPB72-221002300 fits Leland 7920/7921/7925/7926 & 221002300

## TO ORDER A MORryde PIN BOX SYSTEM PLEASE IDENTIFY THE FOLLOWING:

- The Part Number of the stock pin box (usually found on a label on the pin box)
- The GVWR of the trailer: MORryde has a specific rubber spring for different weight ratings

\* GVWR above are general guidelines and may not directly correlate to shear spring density

**OR** If the stock part number is not available, determine the bolt pattern (A), width (B), and distance from center of king pin to center of first row of bolts (C), then search for the Rubber Pin Box identification guide to convert these measurements into a MORryde part number.

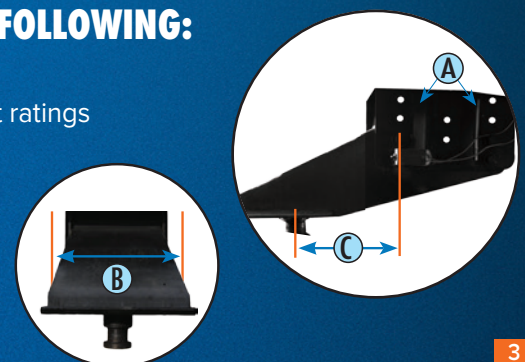

# SUSPENSION SYSTEMS

Protection from damaging road shock



## SRE4000 SUSPENSION

Designed for premium performance, and used by mid and high-end 5th wheel and travel trailer builders.

- Smoother towing than conventional leaf springs
- Provides 4" of suspension travel
- Protects from damaging road shock
- Easy bolt-on installation
- 3 year warranty
- Includes X-factor crossmember to reduce frame stress

**PREMIUM**  
*Performance*

5,200 TO 7,000 GAWR		
	Part Number	Wheel Base
Tan-	SRE2-733X	33"
	SRE2-735X	35"
Triple	SRE3-733X	33"
	SRE3-735X	35"



To find your wheel base, measure from center of hub to center of hub



## CRE3000 SUSPENSION

Designed for towing improvement over the standard stock equalizer.

- Smoother towing than conventional leaf springs
- Provides 3" of suspension travel
- Protects from damaging road shock
- Unique travel slot for increased wheel travel
- Easy bolt-on installation
- 2 year warranty
- Utilizes rubber to cushion shock

**BEST** in  
*Class*

3,500 - 8,000 GAWR		
	Part Number	Wheel Base
Tan-	CRE2-33	33"
	CRE2-35	35"
Triple	CRE3-33	33"
	CRE3-35	35"



**IT'S ALL ABOUT THE TRAVEL!**

UNIQUE TRAVEL SLOT

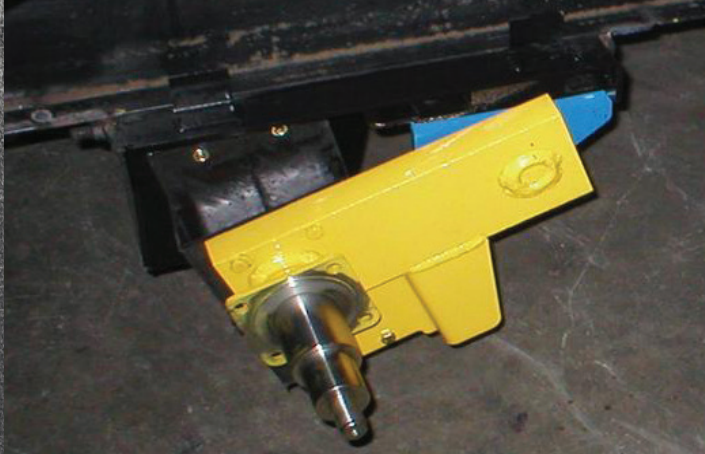

## INDEPENDENT SUSPENSION

Double rubber spring assembly improves the suspension system's ability to absorb road shock and makes towing smoother.

- Superior towing smoothness
- Improved towability & handling
- Better protection of trailer, components, & contents from damaging road shock
- Beam assembly allows maximum wheel travel, which significantly smoothes the trailer's passage over a rough road surface.



## HEAVY-DUTY SHACKLE

The heavy-duty shackle kit is an excellent upgrade for your running gear.

- Thicker shackles for added strength
- Bronze bushings for more durability
- Greasable bolts for less maintenance
- Complete peace of mind
- Loctite nuts to ensure stability

Order kit according to your current suspension system:

		Part Number Standard Frame Hanger	Part Number OEM Correct Track Hanger
MORryde LRE	tandem	LRE12-001	LRE12-016
	triple	LRE12-004	LRE12-017
MORryde <b>SRE</b> 4000	tandem	UO12-016	UO12-029
	triple	SRE12-001	SRE12-002
MORryde <b>CRE</b> 3000 and Stock or Equaflex with 2-1/4" shackles	tandem	UO12-016	UO12-029
	triple	UO12-02	UO12-030
Stock or Equaflex with 3-1/8" shackles	tandem	UO12-021	UO12-031
	triple	UO12-024	UO12-032

## X-FACTOR CROSSMEMBER

- Designed to greatly reduce frame stress
- Provides added lateral strength
- Uses high-strength low-alloy steel
- Adjustable to fit different frame widths
- Easy installation
- No welding necessary

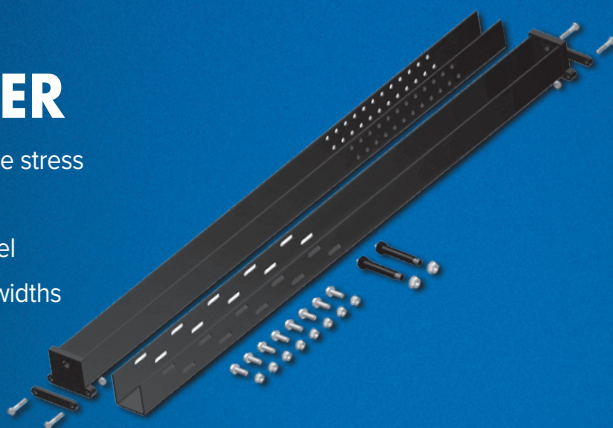

## XFACTOR PERFORMANCE CROSSMEMBERS\*

Part Number	Description
RE21-004	Crossmember for MORryde LRE, RE & TRE suspensions
UO21-003	Crossmembers for SRE, CRE, stock & other equalizers

\* Only one crossmember per kit. Additional crossmembers are available for purchase.



More Stable. More Secure. MORryde.

# THE STABLE STEP SOLUTION



**StepAbove™** — the industry's first self-contained, lightweight, and ground-stable RV step system that brings secure footing every step of the way.



# No more bouncing in and out of your RV.

- Lightweight
- Stable entry to and exit from your RV
- Stores securely right inside the door
- Unique twist handle to release the StepAbove™ steps
- Adjustable feet to accommodate for uneven terrain
- 500 LB weight capacity
- Optional handrail



Get added stability with the StepAbove™ optional handrail. Available for three and four step models.



Easily turn the handle to release the steps, lower the lightweight steps to the ground, and enjoy solid entry to and exit from the RV.

## STEPABOVE FIT CHART

	Part Number:	Height Range* (in)	Door Size Width (in)**
<b>2 STEP</b>	STP-2-27-01H	25 - 29	26 - 28
	STP-3-27-02H	30 - 33.5	26 - 28
<b>3 STEP</b>	STP-3-30-03H	30 - 33.5	30 - 32
	STP-3-27-05H	34 - 36	26 - 28
	STP-3-30-04H	34 - 36	30 - 32
<b>4 STEP</b>	STP-4-27-05H	36.5 - 42	26 - 28
	STP-4-30-03H	36.5 - 42	30
	STP-4-32-04H	36.5 - 42	30 - 32
<b>HANDRAIL</b>	3 Step Handrail - STP214-007H		
	4 Step Handrail - STP214-006H		

\* Height is the measurement from the top of the threshold to the ground.

\*\* Door size width - most models come with adjustable brackets.

# TV MOUNTS

Our steel TV mounts are well known for rugged quality and sleek functionality. Perfect for recreational vehicles, hospitality suites, and home patios.

## BASE MOUNTS



### SLIDE OUT

Designed to swivel and slide out, this bracket is perfect for installation in a cabinet or corner.



- Slides out 7"
- Swivels
- Tilts 0 -10.5°
- Adjust for TV Height
- Up to 200 x 200 VESA

#### DIMENSIONS:

6"W x 17"H (tall) or  
12.5"H (short) x 15.8"D

50lb

TV40-001H (TALL)  
UP TO 55" TV

TV40-001H-S (SHORT)  
UP TO 32" TV

### BASE OR CEILING

This mount is excellent for under-cabinet installation or reinforced ceilings. It can also be mounted to a counter or desk for a great monitor mount.



- Swivel and tilt
- Up to 100 x 100 VESA
- Up to 28" TV
- Requires reinforced structure when used as a ceiling mount

#### DIMENSIONS:

6.5"W x 11.5"H or  
4.5"D

25lb

TV1-012H

### RIGID ADJUSTABLE

This low profile TV mount with adjustable mounting height is perfect for your new flat screen. Easy to install and the hardware is included.



- Adjust for TV Height
- Up to 200 x 200 VESA
- Up to 40" TV
- Base plate faces toward the front

#### DIMENSIONS:

8.9"W x 12.4"H (min) or  
17.6H (max) x 6"D

50lb

TV1-003H

### RIGID

The different height positions allow you to adjust for TV height and viewing angle. It mounts to a horizontal surface, counter, or RV cabinet and no assembly required.



- Adjust for TV Height
- Up to 200 x 200 VESA
- Up to 50" TV
- Base plate faces toward the back

#### DIMENSIONS:

8.9"W x 15"H (min) or  
20.15"H (max) x 8"D

50lb

TV1-009H



# WALL MOUNTS

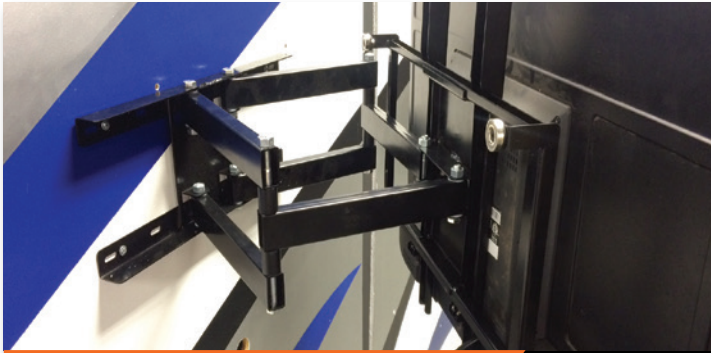

## PULL OUT

The unique double arm swiveling function allows for the TV's angle to be changed from side to side. It simply pushes back into place and is held down with magnets to keep your TV secure.



- Low profile when closed
- Pulls straight out
- Great for exterior entertainment centers
- Swivels for a variety of viewing positions
- Locks in place for safe travel
- Up to 400x400 VESA

TV1-084H

### DIMENSIONS:

22.6"W x 17"H x 2.7"D (closed)  
or 20"D (extended)



## DROP DOWN

The Drop Down Wall Mount moves out from the wall and drops down for a better viewing angle. The ability to drop your TV mount down allows you to reduce the glare that is all too common.



- Low profile when closed
- Pulls straight out
- Great for exterior entertainment centers
- Swivels for a variety of viewing positions
- Locks in place for safe travel
- Up to 200x200 VESA

TV56-129H (Pantograph)

### WEIGHT CAPACITY:

12lbs (min) - 20lbs (max)

### DIMENSIONS:

Up position: 13.3"W x 17.6"H x 5.2"D  
Down position: 13.3"W x 29"H x 8.5"D



## Which TV Mount is best for your application?

### What is the VESA hole pattern of your TV or monitor?

(Video electronics standards association)

MORryde mounts are available in several VESA patterns\*:

75 x 75	300 x 300
100 x 100	400 x 400
200 x 200	

### How much does the TV or monitor weigh?

MORryde mounts are available in several weight capacities:



### Where will the TV be installed?

Range of motion desired:

- **SWIVEL** left to right
- **SLIDING** in & out
- **TILT** up & down
- **FLIP** up or down

## DROP DOWN MOUNT ADAPTOR KIT

Attach the Drop Down Wall Mount to a horizontal surface with this adaptor kit.

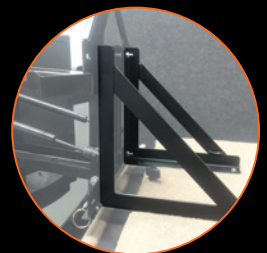

TV54-021

# TV MOUNTS

## WALL MOUNTS

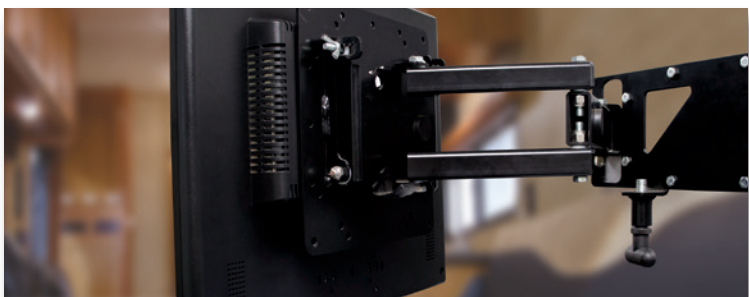

### SWINGING

This mount is excellent for under-cabinet installation or reinforced ceilings. It can also be mounted to a counter or desk for a great monitor mount.



- Tilt & Swivel Adjustment
- Tilts 0-10.5°
- TV Swivels up to 360°
- Up to 200x200 VESA

TV1-021H 

TV1-006H 

#### DIMENSIONS:

11.25"W x 11"H x 3.28"D (closed)  
or 18"D (open)



- Up to 100 x 100 VESA

TV1-025H 

#### DIMENSIONS:

10.5"W x 8.9"H x 3.45"D (closed)  
or 18"D (open)



Extends  
25"

- Extends 7" farther than our other Swinging Wall Mounts
- Strap release
- 180° of swing
- Swivel and tilt
- Locks in for safe travel
- Up to 200 x 200 VESA

#### DIMENSIONS:

14.8"W x 10.5"H x 3.3"D (closed)  
or 25"D (open)

TV1-087H 

### SNAP-IN

The newest line of MORryde TV Mounts allow for easy removal and reattachment of a flat screen TV without the hassle of unscrewing the TV from the mount.

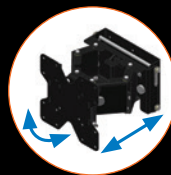

#### EXTEND & SWIVEL

200 x 200 VESA

TV10-E-35H 

#### DIMENSIONS:

10.5"W x 8.9"H x 5.3"D (min)  
15.3"D (max)

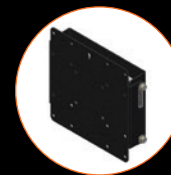

#### RIGID

200 x 200 VESA

TV10-F-35H 

#### DIMENSIONS:

9.8"W x 8.8"H x 2"D



#### SMALL RIGID

100 x 100 VESA

TV1-051H 

#### DIMENSIONS:

5.8"W x 5"H x 1.75"D



#### LARGE RIGID

400 x 400 VESA

TV1-048H 

#### DIMENSIONS:

18.5"W x 16.5"H x 1.1"D



#### SWIVEL

200 x 200 VESA

TV10-S-35H 

#### DIMENSIONS:

9.8"W x 8.5"H x 3.8"D

## PORTABLE MOUNTING PLATE

### SWIVEL OR RIGID

This mount is excellent for under-cabinet installation or reinforced ceilings. It can also be mounted to a counter or desk for a great monitor mount.



- Low profile
- Up to 200 x 200 VESA
- Single stud install
- Swivels up to  $\pm 15^\circ$

TV1-001H (Swivel)

TV1-002H (Rigid)

50lb

#### DIMENSIONS:

8.75"W x 11.3"H x 4"D (swivel)  
or 1.1"D (rigid)

Place multiple docking plates anywhere for entertainment where you want it. Up to 100 x 100 VESA and single stud installation.



SWIVEL &  
TILT

TV5-002H

25lb

#### DIMENSIONS:

5"W x 5.25"H x 2.5"D



EXTENSION w/  
SWIVEL & TILT

TV5-003H

25lb

#### DIMENSIONS:

5"W x 6.75"H x 9"D



LOW PROFILE  
RIGID

TV5-004H

25lb

#### DIMENSIONS:

4.75"W x 4.25"H x 0.75"D



RIGID & SWIVEL  
EXTENSION PORTABLE

TV5-005H

25lb

#### DIMENSIONS:

4.75"W x 6.5"H x 10.5"D

## HORIZONTAL SLIDING MOUNTS

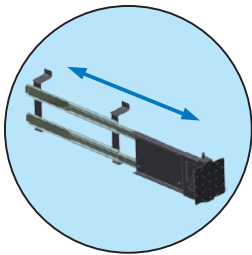

### ADJUSTABLE BAGGAGE COMPARTMENT MOUNT

- 200 x 200 VESA
- Extends 20.5"
- Pivots 120°
- Space saving

TV40-002H

50lb

#### DIMENSIONS:

24"W (min) 60"W (max) x 13"H  
x 6.5"D (min) or 9.5"D (max)

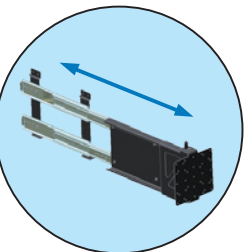

### SLIDES OUT

- 200 x 200 VESA
- Extends 20.5"
- Pivots 120°
- Space saving

TV40-011H

35lb

#### DIMENSIONS:

24"W (min) 60"W (max) x 13"H  
x 4.6"D

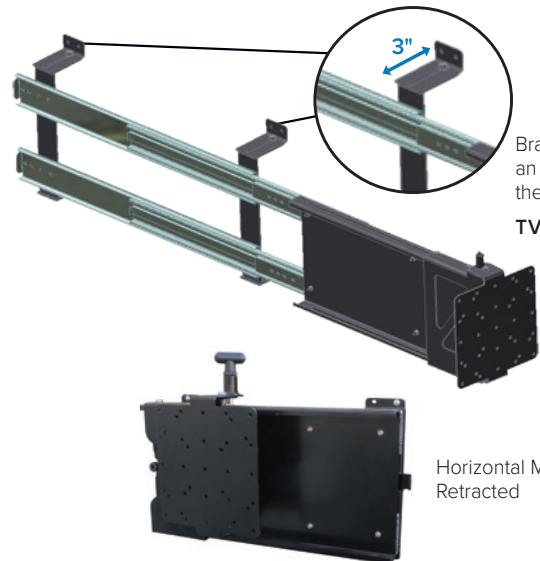

Brackets extend an extra 3" to clear the cargo bay lip

TV40-002H

Horizontal Mounts - Retracted

# TV MOUNTS

## CEILING MOUNTS



### DROP DOWN

The drop down ceiling mount saves space and allows you to keep your TV out of the way until it is needed. The friction pivot lowers the TV slowly and allows you to position it at many viewing angles. This mount is perfect for storing your TV in cabinets and tight spaces.



- Swings down from ceiling
- Friction pivot allows for a variety of viewing angles
- Up to 24" TV
- 75 x 75, 100 x 100, 100 x 200, 200 x 200 VESA

TV1-080H

25lb

**DIMENSIONS:**  
(in down position)

8.6"W x 14.77"H x 5.58"D

### FLIP DOWN

This mount is excellent for under-cabinet installation or reinforced ceilings. Flip down while viewing and flip up to store it out of the way.



- Swings up & out of the way
- Locks in for safe travel
- Swivel & tilt
- Up to 24" TV
- 100 x 100 VESA

TV56-010H

25lb

**DIMENSIONS:**  
(in down position)

6.5"W x 12.8"H x 8"D

### SLIDE-OUT & FLIP DOWN

The TV40-010H mounts to a horizontal surface or ceiling, most commonly inside a basement cargo bay. It can then slide out of the compartment, flip down, and swivel.

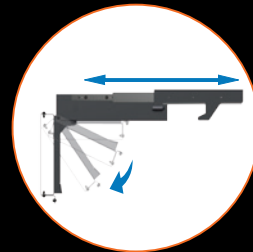

- Ideal for baggage compartments
- Slides out 17"
- Swivel & Tilt
- 200 x 00 VESA

TV40-010H

35lb

**DIMENSIONS:**

8"W x 7.5"H x 21"D (min)  
38"D (max)

## ADAPTOR PLATES

VESA

200 x 200  
300 x 300  
400 x 400

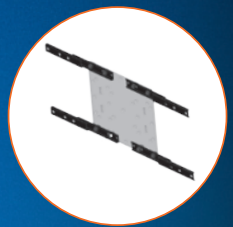

TV54-014H

Two Configurations Available

VESA

100 x 200  
200 x 200

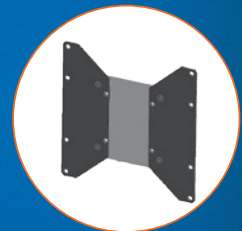

TV54-009H

VESA

300 x 300  
300 x 400  
400 x 400



TV1-008H

# SPECIALTY MOUNTS

## EXTERIOR ENTERTAINMENT CENTER



(TV and speakers not included)

Who says entertainment was only meant for indoors? Take relaxation to the next level with MORryde's Exterior Entertainment Center. Enjoy the sights and sounds of your favorite movie all while in the great outdoors.

- Fully assembled
- Includes high-quality aluminum door & frame
- Slim profile
- 100x100, 100x200, 200x200, 200x400 VESA

EC56-032BLK

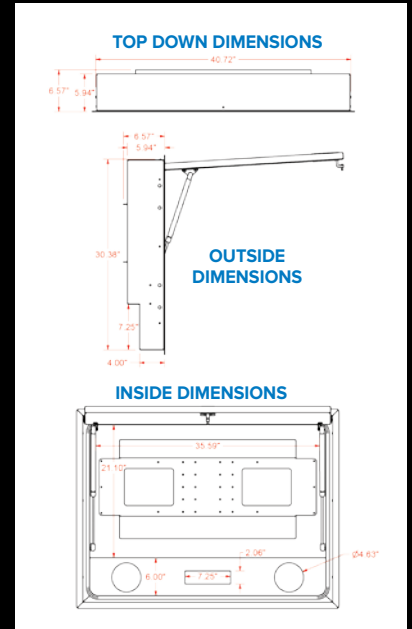

## MOTORIZED VERTICAL MOUNT



This sleek design allows for installation behind a fireplace, book shelf, couch, or any other furniture. No bulky TV table.

- Hides behind any furniture
- Requires 12 Volt Power
- Self-contained motor
- Up to 200 x 200 VESA

**DIMENSIONS:**

18.8"W x 3.75"D  
(Height and lift height vary)

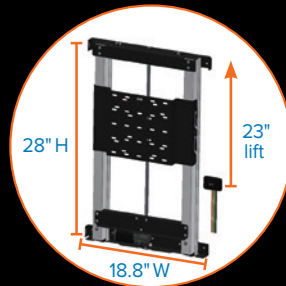

TV25-2823

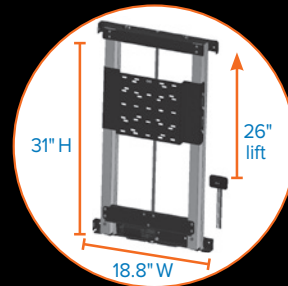

TV25-3126

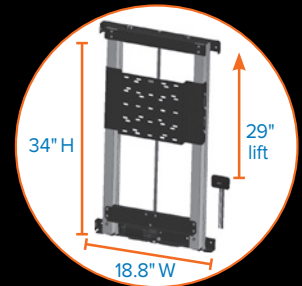

TV25-3429

Remote Available - #UO137-022 (sold separately, lift includes momentary switch)

(TV not included)

# SLIDING TRAYS

Variety of storage solutions makes it easier to reach, organize, and stow your gear

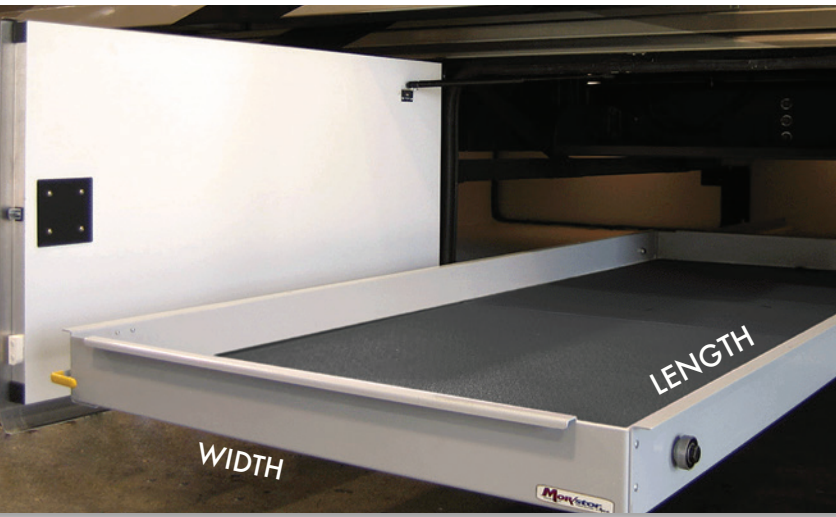

## CARGO TRAYS\*

- Fully assembled
- Finished carpeted flooring
- No measuring or cutting the floor
- Ready to install in minutes!
- 800 lb Capacity
- 60% Extension
- Durable powder coat

Desired length of cargo slide in inches

	36	48	60	72	90*
20	CTG60-2036W	CTG60-2048W	CTG60-2060W	CTG60-2072W	CTG60-2090W
26	CTG60-2636W	CTG60-2648W	CTG60-2660W	CTG60-2672W	CTG60-2690W
29	CTG60-2936W	CTG60-2948W	CTG60-2960W	CTG60-2972W	CTG60-2990W
33	CTG60-3336W	CTG60-3348W	CTG60-3360W	CTG60-3372W	CTG60-3390W
36	CTG60-3636W	CTG60-3648W	CTG60-3660W	CTG60-3672W	CTG60-3690W
39	CTG60-3936W	CTG60-3948W	CTG60-3960W	CTG60-3972W	CTG60-3990W
42	CTG60-4236W	CTG60-4248W	CTG60-4260W	CTG60-4272W	CTG60-4290W
48	CTG60-4836W	CTG60-4848W	CTG60-4860W	CTG60-4872W	CTG60-4890W
52	CTG60-5236W	CTG60-5248W	CTG60-5260W	CTG60-5272W	CTG60-5290W

\* The 90" trays slide out from both sides of a unit. Standard cargo trays have a lip clearance of 1.6".

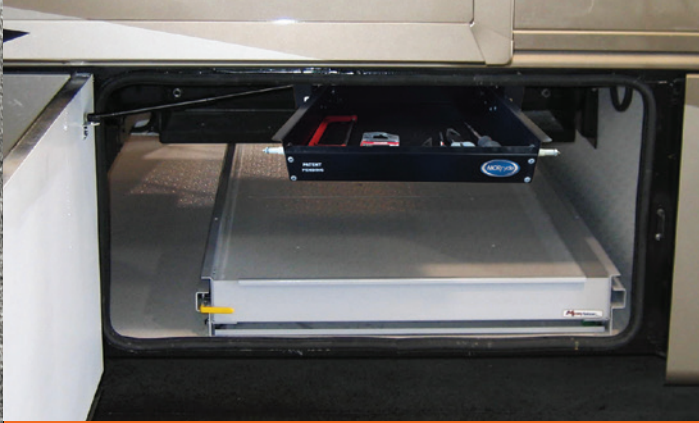

## HIDDEN DROP DOWN TRAY

- Installed in the recess at the top of the storage compartment
- Stays hidden while tray is closed
- Glides down and out to easily access contents, then slides back into place out of the way
- 70% Extension
- Durable powder coat

**SP56-203H**

Tray is 26.3"W x 16.1"L x 2.7"H. Adjustable brackets allow hidden tray to fit in the under floor framing with spacing between 20"L (min) - 26"L (max)

Patent Pending



(Freezer not included)

## FREEZER TRAYS

These 200% extension slides are great for your freezer, refrigerator, or any cargo that you would like to access past the unit's slideout.

- 225 lb weight capacity
- Dual latches for safe travel
- Ready to install in minutes
- Durable powder coat

PART NUMBER	DESCRIPTION (W X D X H)
<b>SP56-115</b>	O.D. - 37.6" x 21.6" x 3.5"
Front Pull	I.D. - 31.42" x 19.7" x 3.5"
<b>SP56-132</b>	O.D. - 18" x 26.5" x 3.5"
Side Pull	I.D. - 14" x 24.8" x 3.5"

## BATTERY TRAYS



- Conveniently stores common RV generators
- Durable powder coat
- 100% extension
- Ball bearing slides
- No assembly required
- Durable powder coat

Part#	Description (w x d x h) * inside dim.
<b>SP60-041</b>	14" x 14" x 2.75" 250lb cap
<b>SP60-042</b>	14" x 21" x 2.75" 250lb cap
<b>SP60-043</b>	21" x 14" x 2.75" 250lb cap
<b>SP60-044</b>	24" x 24" x 2.75" 300lb cap

\* Add 2" for overall width and 2" for overall depth to get outside dimensions.

## LP TRAY



- Conveniently secures up to 2 LP tanks
- Hardware for tank attachment included
- Durable powder coat
- 175 lb weight capacity
- 100% extension

**SP62-009**  
10.89" W x 26.51" D x 2.27" H  
Front Pull

Rod included to hold tanks down is 30" long. Slide raises tanks by 1.42"

# EASY REEL™ SPOOLER

Easily store your 30 or 50 amp power cord  
Maximize storage space



## EASY REEL SPOOLER

The Easy Reel™ delivers the simplest, smoothest, and most convenient way to effectively store your power cord.

- Neatly stores your 30 or 50 amp power cord
- Uses a small footprint, freeing up valuable storage space
- Smooth, easy reel operation means no more strain
- Sleek design allows for efficient cord storage - helps maximize your storage space
- Installs easily with just a few screws
- Rugged steel construction
- Powdercoat finish
- Patent pending



*Easy Reel Spooler - Tall*

**DIMENSIONS:**

7.6" W x 17.6" H x 21" D  
Stores up to 50'

**REEL56-001H**



*Easy Reel Spooler - Short*

**DIMENSIONS:**

13.5" W x 14" H x 17.4" D  
Stores up to 50'

**REEL56-004H**

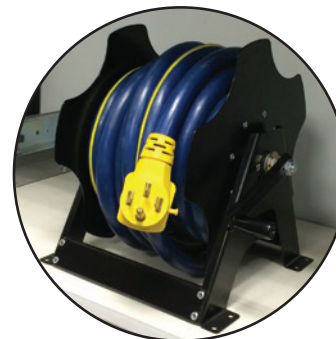

*Easy Reel Spooler - Economy*

**DIMENSIONS:**

14.3" W x 13.4" H x 12.8" D  
Stores up to 30'

**REEL56-009H**



# SPECIALTY PRODUCTS

Our passion for solving problems has led to many unique products



## THE CHAIR BUDDY™

The Chair Buddy™ eliminates bulky, awkward straps and securely holds your dinette chairs in place.

- Conveniently secures dinette chairs
- Prevents interior damage
- Adaptor available for tables without center post (Sold separately)
- Quickly folds up out of the way when chairs are needed
- Installs in minutes
- Patent pending

Chair Buddy - CB56-001H

Adaptor Plate - CB56-002H

The table post must have a flat surface parallel to the side of the table where the chairs are stored and the mounting area must be at least 2" wide x 4" tall. The adapter plate can be used if the table does not meet these requirements.



## SWEET MATTRESS DECK SLIDE

Motorized slide pulls the mattress away from the headboard up to 24" to easily reach all sides of the bed.

- Reduces the back strain caused by bending and stretching to make your bed
- Motorized slide pulls the mattress away from the headboard up to 24" with the push of a button
- In/Out switch located on both sides of the bed
- Maintains the same amount of storage space below your bed
- Patent pending

SP54-036

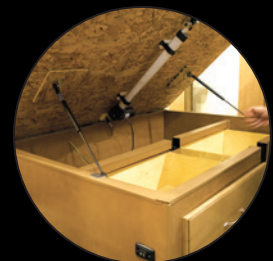

# NEW JEEP ACCESSORIES

by MORryde INTERNATIONAL, INC.



Combine the Heavy-Duty Hinges, Tailgate Reinforcement, and Spare Tire Carrier for a maximum strength tailgate upgrade

## TAILGATE UPGRADE KIT



### HEAVY-DUTY HINGES

(JK AND TJ OPTIONS AVAILABLE)

- Eliminates the breakage-prone plastic factory hinge covers
- Only hinge on the market that's greaseable for long life and smooth operation

### TAILGATE REINFORCEMENT

(JK AND TJ OPTIONS AVAILABLE)

- Eliminates weak points in the factory tailgate and hinge system
- Compatible with the factory spare tire carrier (or upgrade to the MORryde heavy-duty spare tire carrier for even more strength)
- Compatible with the factory bumper or aftermarket bumpers

### HEAVY-DUTY SPARE TIRE CARRIER

(JK ONLY)

- Strong, but lightweight
- Two mounting positions to support most spares up to 40"
- Designed to be used with the HD Tailgate Reinforcement or the factory tailgate
- Comes with an adjustable third brake light stalk which accepts the factory brake light, adjustable to be visible over 40" tires

### SIDE MOUNTS

(JK AND TJ OPTIONS AVAILABLE)

- Carry extra liquid for long trips
- Driver side and Passenger side available
- Does not require drilling any holes in your Jeep



## SIDE MOUNTS



JK Side Mounts



TJ Side Mount

# SLIDEZILLA<sup>®</sup>

## MONSTER STORAGE



Industry's first *elevated* truck bed sliding tray.

## EXPANDING THE BOUNDARIES OF TRUCK BED STORAGE

By an extra 10" to be exact. SlideZilla is 10" wider than the competition. Combine that extra width with two levels of storage, and you'll see how SlideZilla maximizes capacity better than anyone else.



COMBINE WITH A LOWER SLIDING TRAY TO DOUBLE YOUR STORAGE CAPACITY



**DOUBLE THE WORK**

**DOUBLE THE PLAY**

- Installed above wheel wells
- Easily removable tray
- Lock and load deck w/ full extension
- 1,000 lb. and 1,500 lb. capacity options

At MORryde, we have a passion for solving problems. Whether we're fabricating custom solutions, modifying a commercial chassis, or creating our innovative products, we answer to a wide range of markets and deliver on a variety of needs. At MORryde, it's simply about doing MORE for our customers, and it doesn't stop at the sale. We stand behind our products, believing in quality first, service always. No matter the issue, we'll be the first to respond and the last to be satisfied. In short, we build better — together.



Above. Beyond. Always.



Discover other RV hardware on our website.