

USER'S MANUAL



---

# Contents

Introduction .....	3
Safety Precautions .....	3
Specifications .....	3
Components, Service Parts, and Accessories .....	3
Standard Kit Components .....	3, 4
Service Parts .....	5
Fuel System Test Adapters .....	6-7
Assembly .....	8
Bypass Hose .....	8
Flowmeter Faceplates .....	8
Connections .....	8
Adapters .....	8
Banjo Connections .....	9
Flex Hose Connections .....	10
Proper Use, Care, and Servicing .....	10
Principle of Operation .....	11
Fuel Delivery Basics .....	11
Application of the FST .....	11
Diagnosing Fuel Delivery Systems .....	11
Simulating Engine Demand .....	12
Pinpointing Fuel System Malfunctions .....	13
Types of Fuel Delivery Systems .....	14
Return Fuel Systems .....	14
Returnless Fuel Systems .....	14
Mechanically Regulated .....	15
In-tank Filtering/In-tank Return .....	15
External Filtering/In-tank Return .....	15
External Filtering/External Return .....	15
Electronically Regulated .....	16
Identifying Fuel Delivery Systems .....	16
Fuel System Components .....	17
Fuel Tank .....	17
Fuel Pump .....	17
Fuel Inlet Strainer/Sock .....	17
Fuel Filter .....	18
Pressure Regulator .....	18
Fuel Lines .....	18
Setup and Installation .....	19
Determining Where to Install the FST .....	19
Inline Connection .....	19
Alternative Connection Locations .....	19
Selecting and Installing Adapters .....	19
Setting up the FST Pro .....	20
Installing the FST Pro .....	20
Testing and Diagnostics .....	22
Return Fuel Systems .....	22
Returnless Fuel Systems (Mechanical) .....	26
Returnless Fuel Systems (Electronic) .....	28
Fuel visualization .....	31
Pressure Leakdown Test .....	31
Disconnecting the FST .....	32
Appendix A .....	34
Appendix B .....	36
Appendix C .....	38
Appendix D .....	40

---

## Introduction

The Mityvac FST Pro Fuel System Tester is an advanced diagnostic tool designed for troubleshooting and pinpointing common automotive fuel delivery system malfunctions, including:

- Failing fuel pump
- Faulty pressure regulator
- Blocked inline filter
- Blocked inlet strainer/sock
- Pinched or crushed fuel line
- Fuel contamination
- Fuel tank vortex
- Fuel system leaks

This manual focuses on the application of the FST to modern electronic fuel injection (EFI) systems. However, it is equally capable of diagnosing earlier fuel injection systems such as throttle body injection (TBI), continuous injection (CIS) and even pre-fuel injection carbureted systems. A separate low pressure gauge is available from Mityvac for systems that operate below 15 PSI (100 kPa).

## Safety Precautions

The use of this service tool requires the exposure of highly flammable gasoline. To prevent fires, explosions and/or severe injury, always apply extra precautions when diagnosing or working on fuel systems.

The FST Pro is designed for servicing a variety of vehicles in a safe, convenient manner. However, fuel delivery systems vary widely between makes and models of vehicles, potentially requiring additional steps or equipment to perform a proper service job. The procedures outlined in this manual are to serve as guidelines for the use of this equipment. In addition to these guidelines, always follow the manufacturer's recommended procedures when servicing each unique vehicle. Use common sense in the application of this tester and do not attempt to force a test on a fuel system for which this equipment is not designed to perform.

This tester is designed for use on gasoline/petrol or diesel engines only. It is safe for use with gasoline and most gasoline additives, but is not compatible with alternative/flex fuels that contain ethanol.

- Always read carefully and understand instructions prior to using this equipment
- Wear safety glasses at all times
- Operate the vehicle only in a well ventilated area, and away from potential sources of flame or ignition.
- Prior to starting an engine, make sure all components of the tester, body parts, and personal clothing are clear of rotating engine components
- Avoid burns by remaining cautious of engine parts that may become hot when the engine is running
- Never leave a vehicle unattended while testing
- Check and secure all fuel system connections before starting the vehicle or activating the fuel pump
- Wear gloves and protective clothing to avoid the contact of fuel on skin. If contact occurs, immediately wash the area and perform necessary first aid

- Always keep a fire extinguisher on hand when performing fuel related diagnostics. Make sure the extinguisher is rated for fuel, electrical and chemical fires
- Avoid spilling fuel on hot engine parts. Clean-up any fuel spills immediately after they occur

## Specifications

Maximum Flow Capacity: 1.0 gallon/minute (3.8 liters/minute) gasoline/petrol (.73 specific gravity)

Maximum Rated Pressure: 120 PSI (800 kPa) (8 bar)

## Components, Service Parts and Accessories

The Mityvac FST Pro combines the highest quality materials and workmanship to create a durable, finely tuned diagnostic tool, which with proper care will provide years of valuable service. All components are designed and quality controlled in the U.S.

Following is a list of standard components, service parts and accessories relating to model MV5545. Components and accessories are available through your Mityvac dealer.

### Standard Kit Components

Model MV5545 includes the following high quality components:

- 3.5" (90 mm) diameter diaphragm style Pressure Gauge
  - 0 to 120 PSI (0 to 8 bar) (0 to 800 kPa) scale of measure
  - Push-button pressure relief valve
  - 360° swivel hook
  - Protective rubber boot
- Flowmeter Assembly
  - Borosilicate glass variable area flowtube with protective shield and precision aluminum float
  - 3-way Flow Control Valve
  - Fuel bypass port
  - Male push-to-connect, quick-change coupler w/ Schrader valve
  - (2x) Male SAE J2044 quick-connects
  - Replaceable faceplates with 0 to 1.0 gallon/minute scale of measurement
  - Protective rubber boot
- (2x) Replaceable flowmeter faceplates with 0 to 4 liters/ minute scale of measurement
- 1/8" (3 mm) ID x 6' (1.8 m) long Pressure Relief Hose
- 1/4" (6.5 mm) ID x 6' (1.8 m) long Bypass Hose
- (2x) Flowmeter Connection Hose
- (2x) Scissor Hose Clamp
- (2x) Hose Plug
- (6x) Quick-connect Replacement Clip
- Custom Storage Case
- Automotive Fuel System Test Adapters (see Fuel System Test Adapters on page 6)

## Standard Kit Components

Part Number	Description
824141	High Pressure Gauge
824149	Pressure Relief Hose (1/8"/3mm ID x 6'/1.8 m long)
824148	Bypass Hose (1/4"/6.5 mm ID x 6'/1.8 m long)
824144	Scissor Hose Clamps (Qty 2)
824147	Flowmeter Hose (3/8"/9.5 mm ID x 4'/1.2 m long)
824173	Hose Plug (Qty 2)
824143	Flowmeter Faceplates (Liters/Minute) includes front and back plate
824142	Flowmeter Faceplates (Gallons/Minute) includes front and back plate
824172	Quick-connect Replacement Clips (Qty 6)
824179	Storage Case



824141



824149



824148



824144



824147



824173



824172



824142



824143

## Accessories

Part Number	Description
MVA500	Low Pressure Gauge
MVA501	Flowmeter Faceplates (0 to 60 Gallons/Hour) includes front and back plate
MVA5549	MotorVac Adapter Set
MVA5552	Pressure Test Accessory Kit
MVA506	Inline Pressure Test Assembly
MVA509	Extended Pressure Test Hose
MVA527	Diesel Flowmeter Faceplates (Gallons/Minute) includes front and back plate
MVA528	Diesel Flowmeter Faceplates (Liters/Minute) includes front and back plate



824179



MVA5549



MVA5552









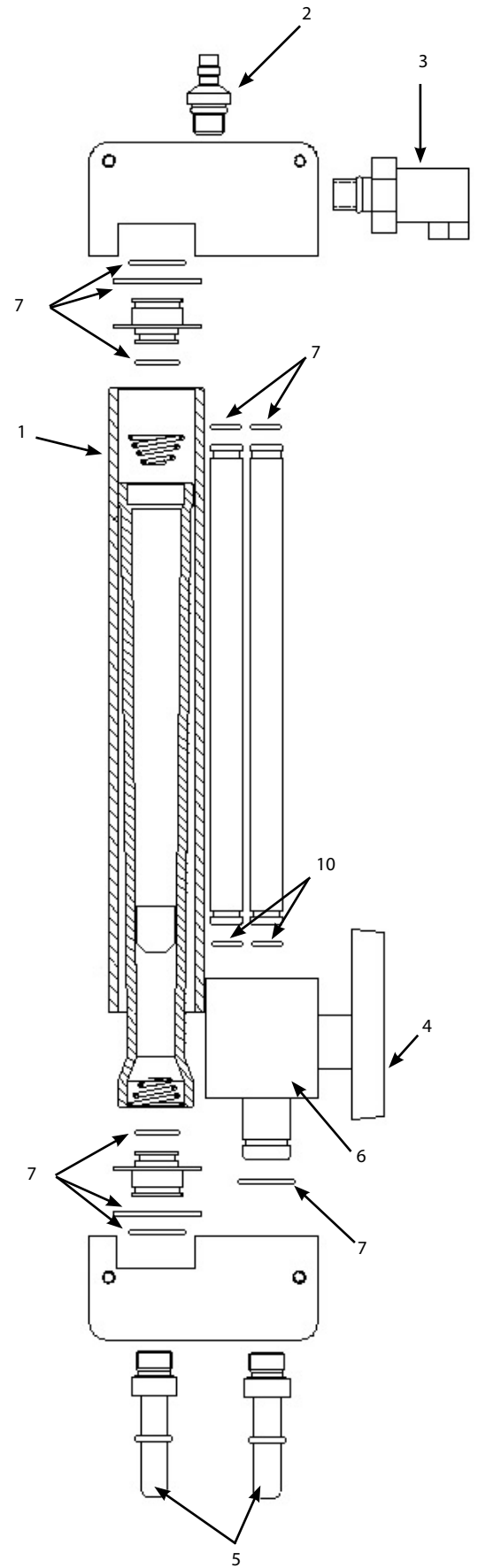













MVA509

# Service Parts

















	Part Number	Description
1	824182	Flow Tube Shield
2	824177	Male Quick-Connect Fitting
3	824176	Bypass Port
4	824175	Flow Control Valve Knob
5	824174	Flowmeter Inlet/Outlet Connector (Qty 2)
6	824146	Flow Control Valve
7	824145	Flowmeter Seal Kit
	824183	Wing-Style Hose Clamp (Qty 4)
	824181	Flowmeter Boot
	824180	Adapter O-Ring Kit
	824178	3/8" Ford Springlok Tether with Clip
	824193	1/2" Ford Springlok Tether with Clip



## Fuel System Test Adapters

Description	Applications	Order No.	Reference No.	
GM/Chrysler Right Angle Test Port Adapter	GM & some Chrysler vehicles with $\frac{7}{16}$ " x 20 thread test port on fuel rail	MVA507**	20	
Ford/Chrysler Right Angle Test Port Adapter	Ford & some Chrysler vehicles with .308 x 32 thread test port on fuel rail	MVA508**	21	
GM/Chrysler Test Port Adapter	GM & some Chrysler vehicles with $\frac{7}{16}$ " x 20 thread test port on fuel rail	MVA510**	18	
Ford/Chrysler Test Port Adapter	Ford & some Chrysler vehicles with .308 x 32 thread test port on fuel rail	MVA511**	19	
$\frac{3}{8}$ " Quick-change Adapter	GM, Chrysler, Jeep/Eagle	MVA512	1	
$\frac{1}{4}$ " - $\frac{3}{8}$ " Barbed Flex Hose Adapter	Vehicles with $\frac{1}{4}$ ", $\frac{5}{16}$ " or $\frac{3}{8}$ " rubber to steel hose connection	MVA505*	16	
$\frac{1}{4}$ " Flex Hose Adapter	Vehicles with $\frac{1}{4}$ " rubber to steel hose connection		16A	
$\frac{5}{16}$ " Flex Hose Adapter	Vehicles with $\frac{5}{16}$ " rubber to steel hose connection		16B	
$\frac{3}{8}$ " Flex Hose Adapter	Vehicles with $\frac{3}{8}$ " rubber to steel hose connection		16C	
M8 x 1.0 Banjo Adapter	Toyota	MVA513	13B	
			13A	
M10 x 1.0 Banjo Adapter	Toyota	MVA514	14B	
			14A	
M12 x 1.25 Banjo Adapter	Toyota, Lexus, Geo, Honda, Acura, Hyundai, Mazda, Daihatsu, Chrysler imports	MVA515	15B	
			15A	
M12 x 1.5 Banjo Adapter	Audi, Volkswagen	MVA516	9B	
			9A	
M12 x 1.5 Ball Nose Adapter	European vehicles with CIS fuel system	MVA517	12A	
			12B	
M14 x 1.5 Ball Nose Adapter	European vehicles with CIS fuel system	MVA518	10A	
			10B	

## Fuel System Test Adapters

Description	Applications	Order No.	Reference No.	
M16 x 1.5 Ball Nose Adapter	European vehicles with CIS fuel system	MVA519	11A	
			11B	
M16 x 1.5 Adapter	GM Vortec	MVA520	3A	
			3B	
M14 x 1.5 Adapter	GM Vortec	MVA521	4A	
			4B	
3/8" Flare Nut Adapter	Carbureted & early fuel injected systems	MVA522	6A	
			6B	
3/8" Flare Nut Adapter	Carbureted & early fuel injected systems	MVA523	5A	
			5B	
3/8" Spring Lock Adapter	Ford fuel injection systems	MVA524	7A	
			7B	
1/2" Spring Lock Adapter	Ford fuel injection systems	MVA525	8A	
			8B	
3/16" Quick-Change Adapter	GM, Chrysler, Jeep/Eagle	MVA526	2B	
			2A	

## Assembly

For flexibility and ease of storage, the FST Pro features a modular design that is quick to assemble and breakdown. Proper assembly for testing is covered in the Setup and Installation instructions

### Bypass Hose

Prior to the first use of the FST, the 1/4" (6.5 mm) ID clear bypass hose should be assembled to the bypass port extending from the side of the flowmeter, above the flow control valve. To connect the fuel bypass hose:

1. Unscrew the compression nut from the fuel bypass port extending from the side of the flowmeter just above the flow control valve (Fig. 1).
2. Slip the compression nut over one end of the clear bypass hose, 1/4" (6.5 mm) ID x 6' (1.8 m) long (Fig. 2).
3. Push the end of the bypass hose over the barb extending from the bypass port (Fig. 3).
4. Slide the compression nut up over the end of the tube and thread it back onto the bypass port. Tighten the nut using a 7/16" open-end wrench (Fig. 4).

### Flowmeter Faceplates

The flowmeter is shipped with faceplates installed on the front and back. The flow scale unit of measure printed on both plates is gallons per minute (GPM). Included with the kit are faceplates with liters/minute (LPM) flow scale. Faceplates printed with a gallons per hour (GPH) flow rate scale can be purchased separately.

The faceplates are held securely by the lip of the rubber boot that surrounds the flowmeter. For accuracy, they pilot on the caps that seal the top and bottom of the flowtube.

To remove the faceplates, simply peel back the edges of the rubber boot. To install new faceplates, match the replacement faceplate to the correct side of the flowmeter, position the cutout over the flowtube, and then carefully work the lip of the rubber boot back over the edge.

## Connections

The hoses that route fuel from the vehicle's fuel delivery system into and out of the FST Pro, utilize a special female quick-connect fitting (Fig. 5). This fitting was selected for several important reasons:

1. It conforms to the SAE J2044 specification for fuel fittings
2. It is a common fuel delivery system connection on which many manufacturers are standardizing
3. It does not restrict fuel flow, which could cause a false diagnosis
4. The connection releases with a simple push-button action. No special tools are required to disconnect the fittings.

The flowmeter inlet and outlet ports, as well as the adapters and fittings that connect the FST into the fuel delivery system, have the complementing male SAE J2044 endform (Fig. 6).

To secure the male to female connection, simply push the male endform into the female quick-connect until it snaps securely into place (Fig. 7). Always test the connection by trying to pull it apart without pressing the release button.

To release the connection, press and hold the release button on the side of the female quick-connect, while pulling the connection apart



Fig. 1



Fig. 2



Fig. 3



Fig. 4



Fig. 7



Fig. 5



Fig. 6



(Fig. 8). Do not attempt to release the quick-connect connection using a disconnect tool, as this may damage the fitting. Replacement clips are included if needed.

### Adapters

The FST Pro includes a selection of adapters for connecting inline with the fuel delivery systems of a wide range of automotive makes and models. The chart on pages 6 and 7 outlines the adapters available, and their applications. Each adapter is etched with an identification number for easy reference. Adapters can be purchased separately in sets according to the order number indicated in the chart.

In most cases, selecting and installing adapters into the fuel delivery system and connecting the FST for testing, is straightforward and logical. Simply match the fuel system connection to the equivalent male and female adapter set, and install them as outlined in the Setup and Installation instructions later in this manual.

### Banjo Connections

Banjo style connections are commonly used by many Asian and European manufacturers to connect a hose or fuel line to the filter and/or the fuel rail. Often, this will be the best place to connect the FST inline with the fuel system. This type of connection may be a little confusing the first time it is encountered.

A banjo connection consists of a round, hollowed-out "banjo" connector with two flat sides. A hollow bolt with a cross-hole passes through the banjo connector and threads into the connecting component (i.e. filter, fuel rail). When the bolt is tightened, it creates a secure face-to-face seal through which the fuel flows. See Fig. 9 for an illustration of this connection.

Two (2) threaded adapters and a closed end nut are required to properly install the FST into a banjo style connection. Refer to the adapter chart on pages 6 and 7 for a list of the banjo adapters included with the FST. To install the banjo adapters:

1. Follow the proper procedure under the Setup and Installation instructions to relieve the fuel pressure and prepare for disconnecting.
2. Loosen and remove the bolt from the banjo connection at the fuel filter or fuel rail.
3. Pass the hollow adapter with the cross-hole through the banjo fitting. Be sure to include a washer on both sides of the banjo fitting (Fig. 10).
4. Thread the closed-end nut onto the end of the bolt and tighten securely with a wrench, trapping the banjo fitting.
5. Thread the hollow bolt adapter without the cross-hole into the filter or fuel rail, in place of the original bolt, and tighten securely with a wrench. Be sure to include a washer between the face of the filter or fuel rail, and the opposing face of the adapter bolt (Fig. 11).
6. Follow normal testing procedures.

NOTE: Always throw away the original used washers, and replace them with new when reconnecting the banjo fitting back to the vehicle's original specification.



Fig. 8

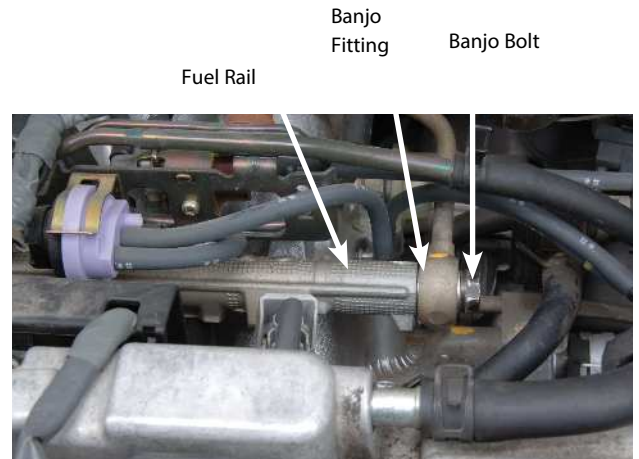

Fig. 9

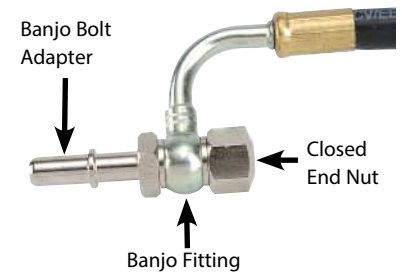

Fig. 10

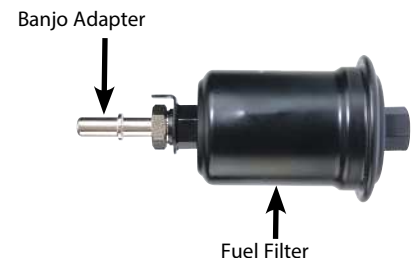

Fig. 11

## Flex Hose Connections

In many cases it is convenient to connect the FST Pro into the fuel delivery system at a location where a flexible rubber hose is secured to a steel fuel line using a screw clamp. A special adapter set is included with the FST Pro for installing it into this type of connection. It includes a universal barb adapter, three flexible hose adapters (1/4", 5/16", 3/8"), and four wing screw clamps.

To install the flex hose adapters:

1. Follow the proper procedure under the Setup and Installation instructions to relieve the fuel pressure and prepare for disconnecting.
2. Loosen the screw clamp securing the rubber hose to the steel fuel line on the vehicle's fuel delivery system, and carefully disconnect the rubber hose. (Fig. 12).
3. Insert the universal barb adapter (#16) into the rubber hose (Fig. 13) and tighten the hose clamp (Fig. 14).
4. Select the appropriate size flex hose adapter (1/4", 5/16", or 3/8"), and install it onto the steel fuel line (Fig. 15). Secure it with one of the wing screw clamps provided (Fig. 16).
5. Follow normal testing procedures.

## Proper Use, Care and Servicing

With proper care and maintenance, the FST Pro will provide years of accurate, reliable service.

The FST is designed for use in testing modern fuel delivery systems on vehicles equipped with gasoline or diesel powered combustion engines.

- CAUTION: DO NOT USE THE FST PRO ON VEHICLES OPERATING ON ALTERNATIVE FUELS SUCH AS E85 OR OTHER "FLEX" FUELS
- Always drain the fuel from the FST prior to storage.
- Always disassemble the FST and return it to the storage case in which it was originally purchased.
- Inspect components regularly for damage and replace or repair as necessary:
  - Check hoses for cracks and cuts
  - Check adapters for damage and wear to threads and sealing surfaces
  - Check female quick-connects for wear and cuts to o-rings
  - Inspect the male and female quick-connect components where the pressure gauge connects to the flowmeter
- After installing the FST and pressurizing the fuel system, check the flowmeter for leaks. If any leaks are evident, immediately relieve the pressure, disconnect the FST, and send it to a service center for repair.



Fig. 12



Fig. 13



Fig. 14

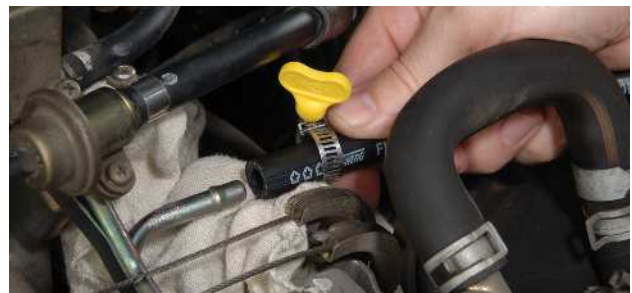

Fig. 15

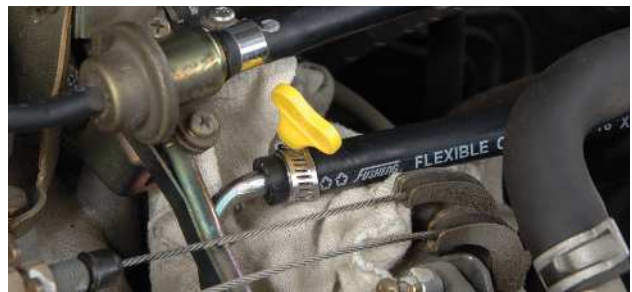

Fig. 16

## Principle of Operation

### Fuel Delivery Basics

Modern fuel injected engines rely on precision fuel delivery to perform at peak output and efficiency. It is the function of the fuel delivery system to ensure that proper fuel pressure and volume are present in the fuel rail to meet the demands of the engine under varying operating conditions. When a fuel delivery system is designed to meet a particular vehicle's requirements, a fuel pump is selected that can deliver at least the maximum fuel pressure and volume requirement of the engine. Other components of the fuel delivery system act upon the output of the fuel pump to ensure the fuel pressure at the injectors is maintained at the predetermined specification.

The maximum volume of fuel required by an engine varies depending on its size. For example, an 8.0 liter engine running at 3,000 rpm could consume as much as .34 gallons of fuel per minute, while a 1.8 liter engine at the same speed would use only .08 gallons per minute. When manufacturers design a fuel delivery system for a specific engine, they consider the fuel requirements based on the size, expected load and speed. This data is used to program the vehicle's Electronic Control Module (ECM), which in turn controls the opening and closing (duty cycle) of the fuel injectors. With the exception of emerging electronically controlled fuel injection systems, the ECM assumes that fuel pressure and volume to the engine are maintained according to the designer's specifications. If a malfunction in the fuel delivery system such as a blocked filter, faulty pressure regulator, or bad fuel pump, causes pressure or flow to vary at the fuel rail, the ECM cannot directly sense this. The only way the ECM can recognize a fuel related problem exists, is through the O2 sensor in the exhaust. The O2 sensor alerts the ECM if the exhaust mixture is rich or lean. The ECM can only respond by opening the injectors for longer or shorter time periods to inject more or less fuel. This may be enough to mask small problems from the driver, but will result in poor fuel efficiency. If the vehicle owner does not notice a decrease in efficiency, and have the vehicle serviced, eventually the malfunction will lead to greater drivability problems.

To help compensate for small fuel delivery problems such as a partially clogged filter, manufacturers build a safety factor into the fuel system so that it is capable of supplying somewhat greater fuel pressure and volume than the engine will ever require. Because of this, if a fuel delivery system is malfunctioning enough to cause a noticeable drivability problem, with the aid of the FST Pro, a technician should be able to accurately diagnose and pinpoint the cause of the problem.

### Application of the FST

The function of the FST Pro is to:

- Inform technicians that there is a malfunction in the fuel delivery system preventing the engine from receiving the optimal fuel pressure and flow it requires to perform at peak efficiency and performance.
- Assist the technician in accurately pinpointing fuel delivery system malfunctions, so as to obsolete current confusing, time consuming, and costly troubleshooting procedures.

The FST is able to perform these functions by providing real-time values for fuel pressure and flow, and by allowing

the technician to simulate varying load conditions on the engine while the vehicle is idling in the shop. These functions are performed by means of a pressure gauge, flow gauge (flowmeter), and a patented flow control valve.

The FST operates by measuring and acting upon the flow of fuel as it is pumped from the fuel tank to the engine by a vehicle's fuel delivery system. To accomplish this, the FST is designed to be connected inline with the fuel system, such that fuel flows normally through the tester just prior to entering the fuel rail.

It is critical that the FST be installed as close as possible to, and directly inline with the fuel rail so that the pressure and flow measurements most accurately represent the conditions experienced by the engine. The further away from the fuel rail that the tester is installed, the more likely the chance that an external factor such as a blocked fuel line will affect the accuracy of the test results. Figure 17 illustrates a typical installation of the FST on a return type fuel delivery system.

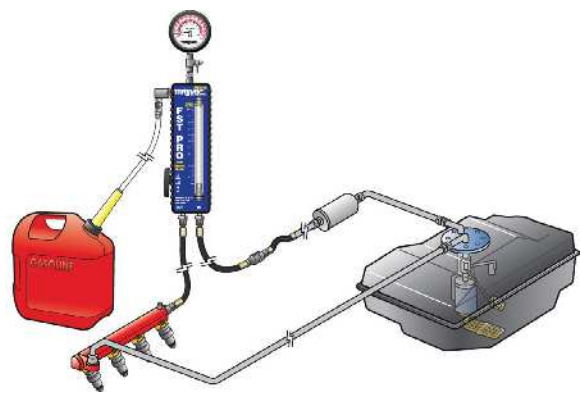

Fig. 17

**NOTE:** When conducting an initial evaluation of the fuel system using the FST, never install it with any component such as a fuel filter or pressure regulator located between it and the fuel rail. Doing so will likely cause the readings to deviate from the pressure and flow that the engine is experiencing, thus reducing the accuracy and the reliability of the test results.

### Diagnosing Fuel Delivery Systems

Upon proper installation of the FST and vehicle startup (see Setup and Installation), the value for fuel pressure at idle will be indicated on the pressure gauge, and the volume of fuel flowing to the engine will be displayed by the flowmeter.

**NOTE:** While normal operating specifications for pressure and flow will vary between vehicle makes, models, years and engines, it is most likely that fuel pressure is the only one for which a documented specification is available.

Regardless of the vehicle's type of fuel delivery system (see Types of Fuel Delivery Systems), the idle pressure can immediately be noted and compared to the manufacturer's specification. However, the idle flow will vary significantly depending on whether the fuel delivery system is return or returnless. Assuming the fuel delivery system is operating properly, the indicated flow of a return system will represent the total volume the pump is capable of producing at the specified pressure. On the other hand, the indicated flow of a returnless system will represent only what the engine is using at idle. Chances are this volume is so low, that it will not even register on the flowmeter.

In regards to return fuel systems, knowing the pressure and flow at idle is a very good indication as to whether the fuel system is functioning properly. However, while pressure can be compared to a manufacturer's spec, idle flow is not typically documented. Most return fuel systems will flow around .5 gallons (2 liters) per minute at idle. However, the idle flow may range from .3 to .7 GPM (1.1 to 2.6 LPM) depending on the vehicle make, model, year and engine. Under a heavy load, a 5.0 liter engine may require as much .5 GPM (2 LPM), while a 2.0 liter engine may only require .2 GPM (.75 LPM). Any return fuel system flowing less than .3 GPM at idle should be considered suspect for a malfunction. Due to flow variances, additional testing described below will provide a more accurate diagnosis of fuel system performance.

Using the FST to test a returnless system at idle will provide a measurement for idle pressure. However flow at idle will provide no additional insight as to its peak performance capability. Using the patented flow control valve on the FST to execute simple pressure and flow demand tests is required for an accurate diagnosis.

### Simulating Engine Demand

At idle, an engine requires very little fuel, and places very little demand on the fuel delivery system. A typical fuel pump is capable of providing up to 30X more fuel than an engine requires at idle. Testing a fuel delivery system at idle may be acceptable if the driver has no intention of actually driving the car, but what happens when a driver needs to accelerate or commit to a driving condition that places a load on the engine?

The key to determining if a fuel delivery system can meet maximum engine requirements is to test it under the engine's most demanding conditions. Using patented technology, the FST Pro is the only tester capable of simulating demand on a vehicle's fuel delivery system to determine if it can meet the peak requirements of the engine.

The FST has a built-in flow control valve that enables an operator to manually vary the flow restriction such that it simulates a car's throttle position from idle, all the way to wide-open. The flow control valve is located on the side of the FST flowmeter assembly. Arrows on the faceplate and rubber boot illustrate the three positions of the valve as OPEN, CLOSED, and BYPASS.

When the valve is in the OPEN position pointing down, fuel flows normally through the tester without affecting the normal operation of the fuel delivery system (Fig. 18). On a return system, .3 to .5 GPM of flow is typical, while a returnless system will indicated little to no flow. Fuel pressure should read within the manufacturer's specification regardless of the type of fuel system.

When the valve is rotated 90° to the CLOSED position, flow through the FST is completely restricted (Fig. 19). On a return system or electronically regulated returnless system, this is referred to as "dead-heading" the fuel pump. The flow will drop to zero, and the pressure gauge will indicate the peak pressure output of the pump. Peak pressure will typically be 50% to 100% higher than the normal operating specification. This is termed the Peak Pressure Test, and is effective only on return or electronically regulated returnless fuel systems. Closing the valve on a mechanically regulated returnless system will have no effect on fuel pressure.

**CAUTION:** A pump should never be dead-headed for longer than a brief instant. Doing so can cause serious damage to the fuel system and/or pump.

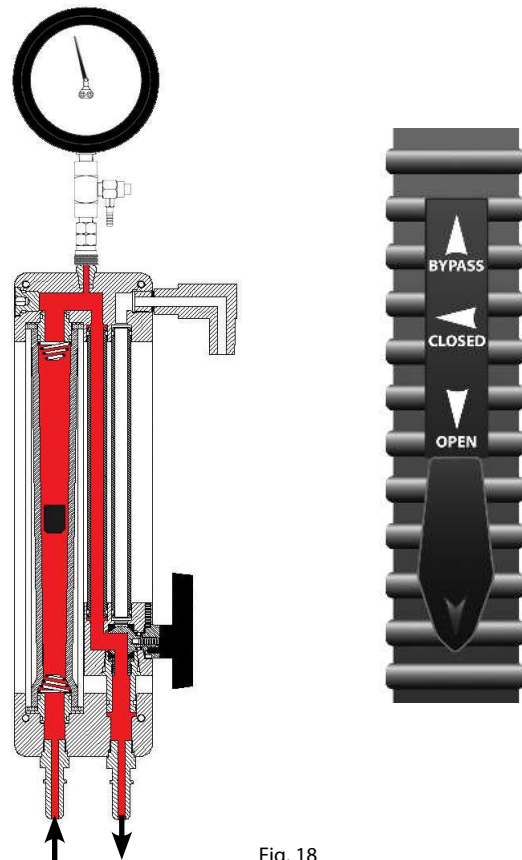

Fig. 18

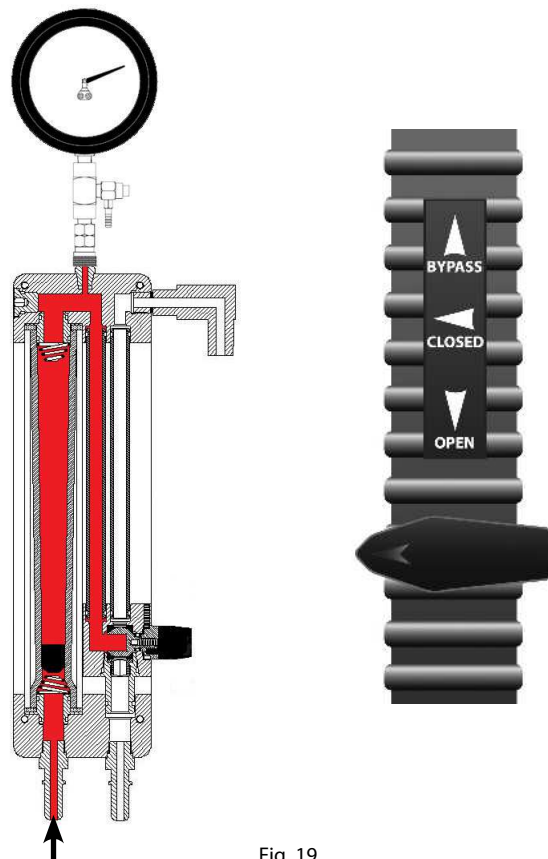

Fig. 19

When the valve is rotated to the BYPASS position pointing up, fuel is routed through the bypass port located on the side of the flowmeter just above the flow control valve (Fig. 20). Bypassing eliminates all restriction to the flow, and the maximum volume output of the pump is indicated on the flowmeter. Fuel pressure will drop to zero. This is termed the Peak Flow Test, and is applicable to return and returnless systems.

If the flow control valve in the CLOSED position is considered to simulate a closed throttle, and the BYPASS position is considered to simulate wide-open throttle (WOT), then any position in-between would represent some unique throttle position between idle and WOT. With this in mind, the operator can simulate any engine demand scenario by simply rotating the valve between CLOSED and BYPASS. By monitoring the corresponding pressure and flow on the FST, the fuel delivery system's ultimate capability to meet engine requirements can be determined.

Although it may sound complicated, applying this principle is quite simple. For example a 3.8L engine with a maximum speed of 6,000 rpm can require an estimated flow of up to .34 GPM (1.3 LPM) of fuel (see Appendix A). Keeping an eye on the flowmeter, the valve should be rotated from the OPEN position, past the CLOSED position until the reading across the top of the float is .34 GPM. The corresponding pressure value should be noted. On a return system or electronically regulated returnless system, the pressure value should be higher than the manufacturer's specification. On a mechanically regulated returnless system, the pressure should be within the manufacturer's specification.

#### Pinpointing Fuel System Malfunctions

To pinpoint the cause of a fuel system malfunction, a simple knowledge of fuel system components, and their affect on system performance, is combined with the results from the tests above to determine the most likely point of failure. For example, initial FST testing of a return fuel system would yield values for four critical performance indicators, Idle Pressure, Idle Flow, Peak Pressure, and Peak Flow. A clogged inline fuel filter would restrict fuel flow, causing low values for idle and peak flow, but idle and peak pressure would remain within spec. An under-restricting pressure regulator would produce a higher than normal idle flow and low idle pressure, but normal values for peak flow and peak pressure. Noting the values of these test indicators, and comparing them to the vehicle's specifications, the technician can in most cases accurately pinpoint the cause of a malfunction.

Testing a returnless system will generate performance measurements for Idle Pressure, Peak Flow, and Peak Demand Pressure. The values for these indicators are applied in the same way, to pinpoint the cause of a fuel system malfunction.

This logic can be applied to all components that can influence fuel delivery system performance. The details of this method are documented in the Testing and Diagnostics section of this manual.

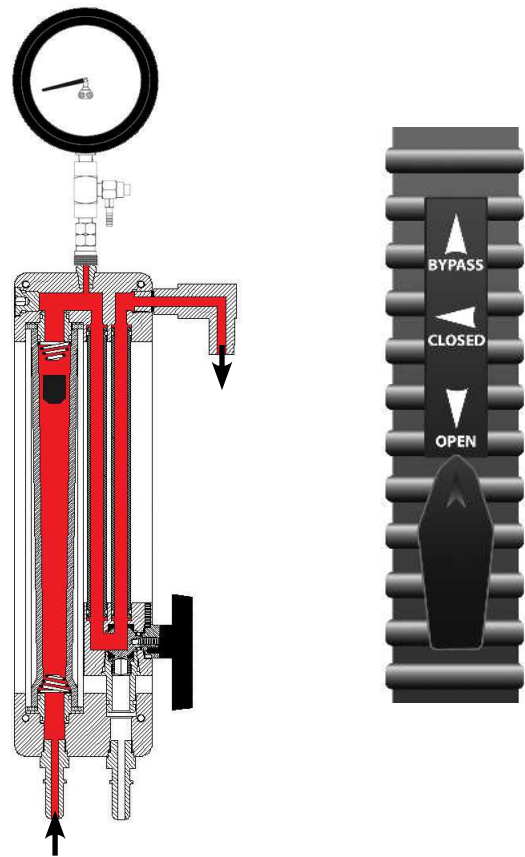

Fig. 20

## Types of Fuel Delivery Systems

For the purpose of accurately applying and testing with the FST Pro, today's fuel delivery systems can be divided into three typical configurations:

- Return (Bypass) Fuel Systems
- Returnless Fuel Systems – Mechanically Regulated
- Returnless Fuel Systems – Electronically Regulated

The fundamental differences between return and returnless fuel systems affect the values for pressure and flow displayed by the FST, and influence its diagnostic capabilities. Even the differences between mechanically and electronically regulated returnless systems produce substantially varying results. The key to achieving the most accurate fuel system diagnosis begins with a basic understanding of the differences between fuel systems, and how the FST responds to each.

### Return Fuel Systems

In a return type of fuel system, a continuous volume of fuel is pumped to the engine via the fuel supply line. The engine uses what it needs, and the rest is returned back to the tank via the fuel return line (Fig. 21). The fuel pump receives power directly from the electrical system. Pump speed is not controlled by any external source, so when the system is functioning properly, it outputs a constant flow.

Fuel pressure in a return system is created by a pressure regulator mounted at the exit point of the fuel rail or fuel return line. As the unused fuel leaves the fuel rail, it passes through the regulator, which restricts the volume of the returning fuel (see Fuel System Components/Pressure Regulator). This causes backpressure to build up in the fuel rail and fuel supply line, all the way back to the fuel pump. This "backpressure" is the pressure at which fuel is delivered to the injectors, and what is referred to by the vehicle manufacturer's specification for proper fuel pressure.

An inline filter is installed in the fuel supply line between the fuel pump and the fuel rail to filter out impurities before they reach the injectors. It's typically mounted under the frame or in the engine bay, making it relatively easy to replace.

A properly functioning return type system will always deliver a much greater volume of fuel to the engine than what it will require, even under a heavy load or a wide-open throttle (WOT) condition. A normally functioning return fuel system will continuously circulate around .5 gallon (2 liters) of gas per minute at normal operating pressure. Ultimately, the fuel system designer determines what the flow will be based on the engine requirements, but it will typically vary between .3 and .7 GPM (1.1 and 2.6 LPM) depending on engine size.

Due to their layout, and the location of critical components, return systems are the most easily and accurately diagnosed by the FST. When installed and operated as recommended, the FST can measure four (4) critical values that combine to precisely diagnose the fuel system and pinpoint any malfunctions.

### Returnless Fuel Systems

The term "returnless" describes fuel delivery systems that do not return unused fuel back to the tank once it has entered the fuel rail. The fuel rail becomes the end of the line, where fuel pumped from the tank remains under pressure until it's used by the engine (Fig. 22).

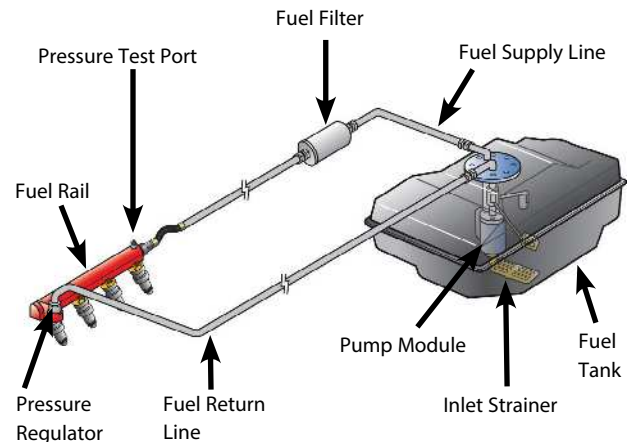

Fig. 21

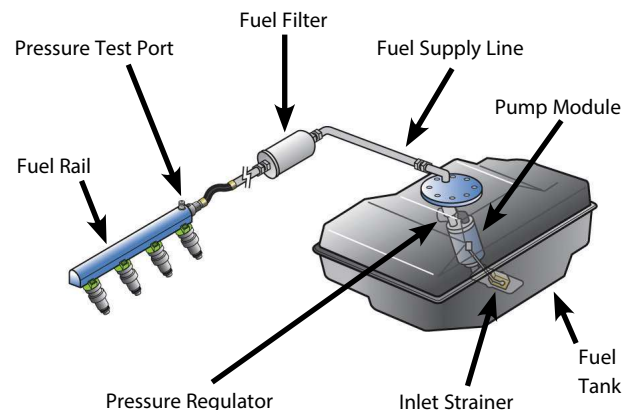

Fig. 22

Returnless fuel systems (mechanically regulated) were pioneered by Chrysler in the mid-1990s. Since that date, other car manufacturers have been implementing returnless systems onto their cars. Now returnless systems are common on most all new cars and light trucks.

### Mechanically Regulated

In the case of mechanically regulated returnless systems, the term "returnless" can be misleading. Like a return system, the fuel pump operates continuously, producing an uncontrolled output. Since the engine will only use a portion of the total pump output, the excess fuel must still be returned. This is done either in the tank, or the fuel is routed just outside the tank for filtering, and then returned.

Mechanically regulated systems utilize a spring operated pressure regulator mounted in the tank as part of the pump module. The regulator is very similar to those used in return systems, except it is not vacuum- or pressure-modulated. Fuel pressure in returnless systems is typically higher than return systems to compensate for the lack of modulation, and to help prevent the fuel from boiling in the fuel rail.

Mechanically regulated returnless fuel systems employ one of three basic concepts to filter the fuel and accommodate the excess output of the pump. All three methods utilize a fuel pump module with built-in pressure regulator. The FST is very capable of diagnosing a malfunction of any of the three variations. However the type of return/filtration method employed has a significant impact on the FST's capability to pinpoint the malfunction. Refer to the Testing and Diagnostics section later in this manual for the proper application of the FST in diagnosing each system. In some cases, pinpointing the exact cause of the malfunction may be irrelevant because the pump, filter, and pressure regulator are all part of a module assembly that must be replaced as a complete unit.

#### In-tank Filtering/In-tank Return

This method involves filtering and returning the excess fuel without it leaving the tank (Fig. 23). Both pressure regulator and filter are part of the fuel pump module. Filtering is accomplished in one of three ways:

- A pre-pump filter is used to filter the fuel before it enters the pump.
- The filter is located after the pressure regulator, where it filters the unused fuel before mixing it back into the fuel reserve.
- The filter is located in the pump module, between the pump and the regulator.

Some manufacturers have designed in-tank filter/regulator systems that use some variation or combination of these three concepts to produce what they consider to be the most effective system. In cases involving in-tank filtering and return, all of the control components are included as part of the pump module assembly, and are most likely replaced as a complete unit.

#### External Filtering/In-tank Return

This system of fuel filtration and return uses a pressure regulator on the pump module to regulate fuel pressure and return unused fuel before it leaves the tank. The main filtration is handled by an inline filter mounted externally between the tank and the fuel rail (Fig. 24).

#### External Filtering/External Return

In this type of filtering/return system, the fuel is pumped out of the tank to an external filter mounted on or near the tank (Fig. 25). The filter serves as a sort of manifold, with a single fuel supply line running into one end of the filter, and two fuel lines exiting the filter. One of the exiting lines supplies fuel to the engine, while the other returns the unused fuel to the regulator and the tank.

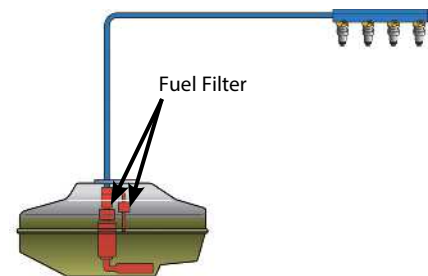

Fig. 23

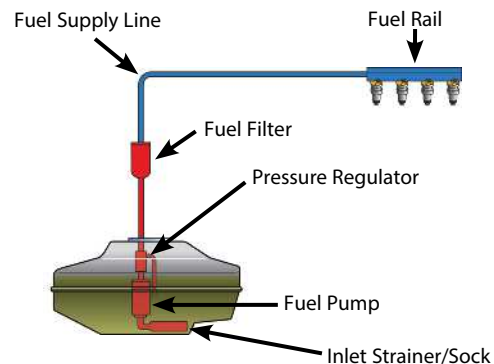

Fig. 24

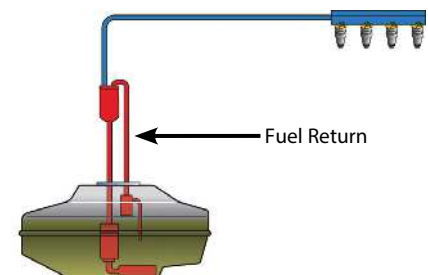

Fig. 25

## Electronically Regulated

Ford began developing an electronically regulated returnless fuel delivery system in the late 1990s, and began implementing it on their cars in the early to mid-2000s. This system shares some of the features and benefits of both return and returnless systems, but with the addition of advanced control technology. The two main differences of an electronically regulated fuel system are the replacement of the mechanical pressure regulator with an electronic pressure sensor, and the introduction of a variable speed fuel pump (Fig. 26).

The fuel pressure sensor is mounted directly onto the fuel rail, which ensures the most accurate reading of the pressure at the injectors. The signal from the pressure sensor is fed to the ECM where it is combined with other inputs such as from the O2 sensor. The ECM processes the data and uses it to control the duty cycle of the injectors and the speed of the fuel pump. Fuel pressure and volume are controlled by the ECM speeding up or slowing down the fuel pump. This eliminates the need for a pressure regulator.

Although a whole new level of technology and control has been introduced with this system, the engine requirements are still the same. The FST is just as effective at diagnosing an electronically regulated system as a mechanical, and the test procedures are just as straightforward.

## Identifying Fuel Delivery Systems

Begin by opening the hood and locating the fuel rail. If the engine has only one bank of cylinders, there will be only one fuel rail. Engines with two cylinder banks will typically have two fuel rails, each feeding the injectors in one of the banks. There will be a crossover between the rails to allow fuel to flow from one side to the other. Fuel rails vary in appearance from simple round tubes to square or rectangular in shape.

Look for the fuel line(s). They typically come up from under the car at the base of the firewall, run up the firewall, and then extend over to the fuel rail(s). A return system will have two lines, one supplying fuel from the tank, the second returning the unused fuel back to the tank. It is easy to confuse fuel lines with lines for the evaporative system, so inspect them closely. Fuel lines will be either steel or fuel rated rubber or plastic.

Return systems will have a pressure regulator typically mounted on the end of the fuel rail, such that unused fuel flows out of the fuel rail, through the pressure regulator, and into the return line. The pressure regulator will typically have a vacuum line attached, which adjusts fuel pressure regulation according to engine load (Fig. 27). Some cars will have a pulse dampener, which can be easily confused with the regulator. The pulse dampener is typically found on returnless systems. It does not have a vacuum line attached to it, and is commonly mounted at the inlet, or extends from the side of the fuel rail.

Returnless fuel systems will have a single fuel line running to the fuel rail. There will be no fuel pressure regulator located at the fuel rail. Electronically controlled fuel systems will have a pressure sensor mounted on the fuel rail. The sensor will have an obvious electrical connection with three to five wires extending from it.

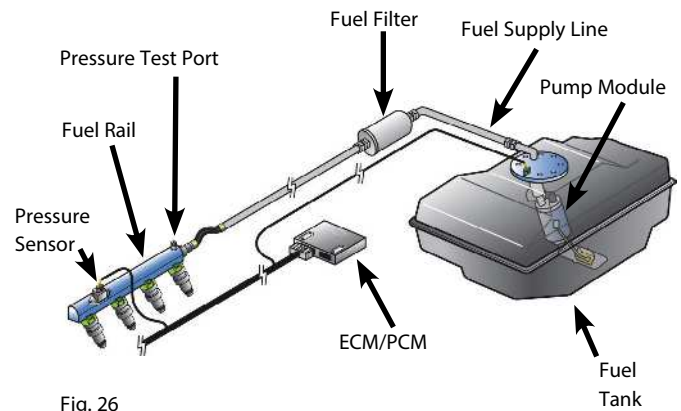

Fig. 26

To Manifold Vacuum or Atmosphere  
Pressure Regulator  
Fuel Return Line

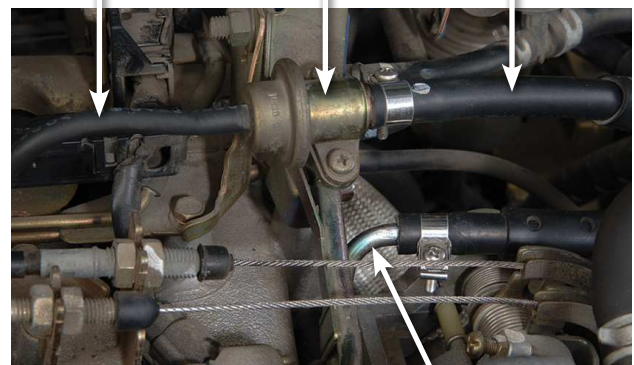

Fig. 27



---

## Fuel System Components

The modern fuel delivery system is comprised of several critical components. A malfunction of one or more of these can cause the system to fail or under perform. The function of the FST is to diagnose when a fuel system failure has occurred, and to pinpoint the component(s) which caused the failure. To reach an accurate diagnosis, a basic knowledge of the fuel system components and their role in achieving optimum engine performance is helpful. Following is a list of common components that contribute to the function of the fuel delivery system. A failure of one or more of these components can typically be diagnosed using the FST Pro:

- Fuel Tank
- Fuel Pump
- Fuel Pump Inlet Strainer/Sock
- Inline Fuel Filter
- Pressure Regulator
- Fuel Lines

### Fuel Tank

The fuel tank serves as a reservoir to store the fuel until it is needed by the engine. Fuel tanks have been manufactured from a variety of metals and plastics. The fuel pump hangs down into the tank, drawing the fuel from very close to the bottom. The most likely influences of the fuel tank towards a fuel system failure would be the result of rust or scale produced by a metallic tank, the collection of impurities introduced from the outside, or a dented tank that interferes with the function of the fuel pump. It is critical that the fuel tank be emptied, cleaned, and inspected any time a fuel pump is replaced or impurities are suspected.

### Fuel Pump

The fuel pump is the heart of the fuel delivery system. It pumps fuel from a vehicle's fuel tank to the engine, where it is mixed with air and injected into the cylinders for burning. Fuel pumps in most modern fuel delivery systems are located inside the fuel tank, and run on electricity supplied by the vehicle's electrical system. They pump a continuous volume of fuel at a given voltage, and are typically extremely reliable when operated under the conditions for which they are designed. Despite their reliability and the high cost and hazard of replacement, fuel pumps have a higher return rate than almost any other

automotive part. They are commonly misdiagnosed and needlessly replaced, costing consumers, repair shops and manufacturers millions of dollars each year. It's estimated that 80% or more of fuel pumps are replaced for non-fuel pump related issues.

Most mechanically regulated fuel delivery systems operate the fuel pump at one speed, based on a constant voltage from the electrical system. However some automotive manufacturers have begun incorporating two or three speed pumps to improve efficiency and reduce emissions. Like electronically regulated returnless systems, the speed of the pump is controlled by the ECM. However the ECM does not increase pump speed based on fuel pressure. In such a case, the fuel pump may not increase speed/output in reaction to the simulated load method used by the FST. Instead, a scanner or manufacturer's software is required to manually increase the speed in order to test the peak capability of the pump. The manufacturer's service manual should document this in their fuel system diagnostic procedure.

Fuel pumps fail or fail to perform due to high mileage, contaminated fuel, or electrical problems. While there is no fix for wear due to high mileage, fuel and electrical problems can be identified, corrected, and prevented. In the case of fuel contamination, it is almost certain the pump will have to be replaced due to irreversible damage. However, electrical issues such as a loose ground, bad connection, or low voltage, can many times be corrected before the pump experiences any permanent damage.

Contaminated fuel is a major cause of fuel pump failures. Dirt, debris and scale can clog the inlet strainer and fuel filter causing the pump to work harder and reduce its life. They also wreak havoc inside the pump by acting like an abrasive to grind at parts. Chemical contaminants can cause precision made components to swell or gum-up, leading to under-performance or complete failure. For all of these reasons, fuel tanks should be completely drained and professionally cleaned, or possibly even replaced, each time a fuel pump is replaced or contamination is suspected.

Check all electrical connections. When electrical connections fail, voltage to the pump will be reduced, causing the pump to run inefficiently and ultimately reducing its life. Check the vehicle harness plugs for soot or burned wires. Check the pump module/hanger plug for melted plastic or loose terminals on the flange. Perform a voltage drop test across all electrical connectors and all electrical components involved with the fuel pump. Also check the wires from the pump to the flange when replacing a pump-only application. A damaged wiring harness, if not repaired, may cause a premature failure to a replacement pump.

Each component of the fuel delivery system has its own unique affect on pressure and flow when it malfunctions. When a fuel pump is failing or under-performing, its total output declines, causing both flow and pressure to drop. When testing a vehicle's fuel delivery system with the FST Pro, the affects of an under-performing pump can be diagnosed by observing how pressure and flow respond to simulated load conditions. Other common test methods such as testing amperage draw or pressure alone can not reliably detect a malfunction, and/or do not have the capability to simulate a load condition. This, combined with a lack of fuel delivery system knowledge and training, leads to the high rate of misdiagnosis.

### Fuel Inlet Strainer/Sock

Fuel flows from the tank through an inlet strainer/sock before entering the fuel pump. It is designed to capture dirt and debris that could damage the pump. Because it is not easily accessible, it is large in size so that it should not have to be replaced except when the pump is serviced or replaced.

If the inlet strainer becomes clogged or plugged, it will limit the amount of fuel flowing to the fuel system, to the point that it will starve the engine of adequate pressure and volume. This can create drivability problems. In addition, a clogged strainer makes the fuel pump work harder to pull fuel through it, and can starve the pump of fuel that it needs for lubrication and cooling. All of these factors can lead to premature pump failure.

---

A clogged inlet strainer can starve the fuel pump of fuel, causing it to cavitate. Cavitation will create rapid changes in fuel density, causing the float in the FST flowmeter to bounce up and down. It can also cause the needle on the pressure gauge to bounce. In addition, as the pump tries to pull gas through the clogged strainer, it creates a pressure drop that may cause air bubbles to form and become visible.

Always inspect the inlet strainer whenever a fuel pump is being serviced. If it is rusty, brown, or dark colored, proper action must be taken to clean and service the tank. Never reuse old filters or strainers, especially when installing a new fuel pump.

## Fuel Filter

Fuel filters ensure that the fuel sent to the injectors is clean. They are installed in the fuel supply line, such that fuel flows from the tank, through the filter on its way to the fuel rail. Filters are typically mounted under the car along the frame, or in the engine bay where they are relatively accessible for periodic replacement.

A clean filter should have little or no effect on the pressure or flow of fuel. A clogged filter becomes a restriction to flow. As blockage in the filter increases, flow decreases. Depending on the type of fuel delivery system and the level of restriction, a clogged fuel filter will cause pressure to increase between the pump and the filter, and/or decrease between the filter and the fuel rail. Because fuel systems are designed to deliver a greater volume and pressure than the engine will require, small blockages may not be noticeable. However, as the restriction increases, it will cause the engine to under-perform and/or stall or hesitate under load. In addition, it causes the fuel pump to work harder, which can lead to premature failure.

The FST Pro can accurately diagnose a clogged fuel filter by comparing flow and pressure levels at idle with those at simulated load conditions.

## Pressure Regulator

The pressure regulator is a component of mechanically regulated fuel delivery systems. It creates and maintains the pressure required by the fuel injectors to perform at their optimum efficiency. While it's the fuel pump that creates the flow of fuel, it's the regulator that creates the pressure by restricting the flow.

The pressure regulator uses a spring to control the amount of restriction based on the pressure in the fuel system. When the engine is off and there is no flow of fuel, the regulator spring completely closes the restriction, trapping pressure in the fuel rail. When the engine is started, the restriction causes the pressure to increase in front of the regulator. When fuel system pressure builds to the optimum level, it overcomes the force of the regulator spring, and the regulator opens to allow fuel to flow through. As the fuel requirements of the engine differ from idle, the regulator automatically increases or decreases the restriction to maintain the optimum pressure at the injectors.

Pressure regulators used in return type fuel systems are mounted on the fuel rail, and are either vacuum or atmospheric modulated. Vacuum modulated pressure regulators use manifold vacuum to maintain a constant pressure differential across the fuel injectors. This means that fuel rail pressure will vary depending on manifold vacuum. At idle, manifold vacuum is high.

This causes the regulator to pass more fuel back to the tank, lowering fuel pressure in the rail. When the throttle is opened, manifold pressure drops. This causes the regulator to close, allowing less fuel flow back to the tank, so fuel rail pressure increases. Vacuum modulation ensures the injectors are receiving the proper fuel pressure for peak engine performance, depending on the engine's requirements.

Atmospheric modulated pressure regulators modify fuel pressure with changes in atmospheric pressure. This allows fuel systems to compensate for changes in altitude. Atmospheric modulated fuel systems rely more on the ECM to control fuel injection performance using other feedbacks such as the O2 sensor, and controlling fuel injector duty cycle.

Mechanically regulated returnless fuel delivery systems use a constant pressure regulator located in the fuel tank, as part of the fuel pump module. It maintains constant pressure due to a fixed spring rate. Fuel pressures in returnless systems are typically higher than return systems, to compensate for the lack of modulation.

When diagnosing a potential pressure regulator failure, consider what happens in the fuel delivery system when the regulator fails to maintain the proper fuel pressure. If the regulator sticks in the open position, such that there is little or no restriction to flow, fuel will flow freely through the regulator and back to the fuel tank. Fuel system pressure may drop drastically below what is required by the injectors. Depending on how low the pressure drops, the malfunction may not be noticeable when the car is idling or running under a minimal load. But if a heavy load condition is introduced on the engine, such as a hard acceleration, the lack of pressure will cause the engine to stumble and lack power.

If the sticking regulator was over-restricting the flow of fuel back to the tank, it would cause fuel system pressure to increase above normal. Because the fuel pump produces much greater flow than what the engine will typically require, this malfunction may not be evident at idle or at minimal load conditions. However, fuel economy could drop severely as the high pressure causes too much fuel to be injected into the engine.

## Fuel Lines

Fuel lines are manufactured from steel, rubber or plastic. They can affect fuel delivery performance if they become clogged, pinched, kinked, dented or ruptured. Because fuel delivery systems keep fuel under pressure, a ruptured fuel line will be evident by leaking fuel. Likewise, most other restrictions can be identified with a simple visual inspection.

A restricted fuel supply line due to damage or blockage will have the same effect as a clogged inline filter. If FST Pro test results indicate a restriction to the supply of fuel, always make a visual inspection of the lines before performing additional diagnostics or replacing a suspect component.

A restricted fuel return line due to damage or blockage will have the same effect as an over-restricting pressure regulator. If FST Pro test results indicate a restriction to the return of fuel, always make a visual inspection of the lines before performing additional diagnostics or replacing a suspect component.

## Setup and Installation

### Determining Where to Install the FST

#### Inline Connection

Regardless of the type of fuel delivery system, the FST Pro is most effective at diagnosing malfunctions when connected inline with the flow of fuel. The initial installation should be made at an access point along the fuel supply line, as close as possible to the fuel rail (Figs. 28, 29 and 30). At this location, the fuel pressure and flow measured by the tester will most accurately represent the conditions within the fuel rail. Due to some engine compartment layouts and connector locations, it may be necessary to connect the tester directly after the in-line fuel filter, which may be located in the engine compartment, under the frame, or near the fuel tank. In this case, be sure to carefully inspect the fuel supply line between the tester and fuel rail for any irregularities such as leaks, crimps, or kinks, as these may cause a false diagnosis based on the tester readings.

#### Alternative Connection Locations

Connecting the FST inline as instructed above for the initial test, ensures the most accurate fuel system diagnosis. However, in some instances it may be beneficial to connect the tester at alternative locations in order to more accurately pinpoint the exact cause of a malfunction. Performing additional diagnostics at different connection locations is detailed in the Testing and Diagnostics section of this manual.

### Selecting and Installing Adapters

The FST Pro includes adapters for connecting the tester inline with the fuel delivery systems of a wide variety of US, European, and Asian manufactured cars and light trucks. In most cases, making an inline connection with the FST requires two adapters, one to connect the fuel line from the fuel tank to the FST inlet, and the second to connect the FST outlet to the fuel line continuing on to the engine.

The FST utilizes female 3/8" SAE J2044 quick-connectors on the ends of the inlet and outlet hoses that connect into the fuel line.

This is the same connection that is used on many newer makes and models of cars. If the vehicle being tested uses this adapter style, only one intermediate adapter will be required. This should be evident upon inspection of the vehicle's connection.

All of the adapters included with the FST have an identification number stamped into them for easy identification. To determine an adapter's size and application(s), use its number to locate it in the Adapter Application Chart on pages 6 and 7.

Most of the adapters and their connection methods are straight forward. Simply match the FST test adapter to the type of fuel line connection used on the vehicle. All adapters should thread or snap together easily to form a leak-proof seal. Always err on the side of caution. If the connection has to be forced, or if there is looseness in the connection, do not attempt to pressurize the system. Contact the Mityvac technical service department at the number on the front of this manual if there are any questions or concerns about the connection.

If you have access to the fuel system adapters manufactured by MotorVac for their CarbonClean® fuel system cleaner, these may be utilized with the FST Pro. Mityvac model MVA5549 MotorVac Adapter Kit is available to make this conversion.

**NOTE:** In many cases it may only be possible to identify the type of connection after the fuel line has been disconnected. However, to

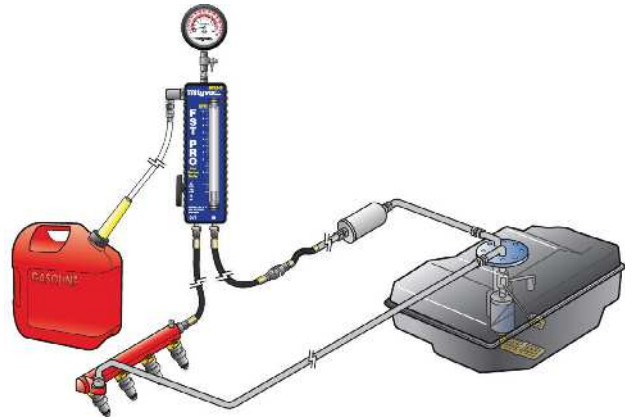

Fig. 28

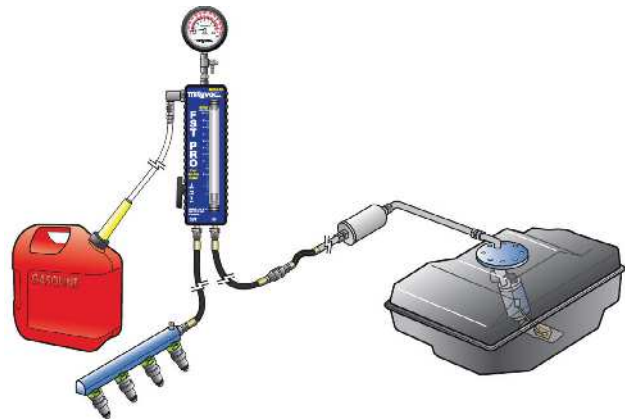

Fig. 29

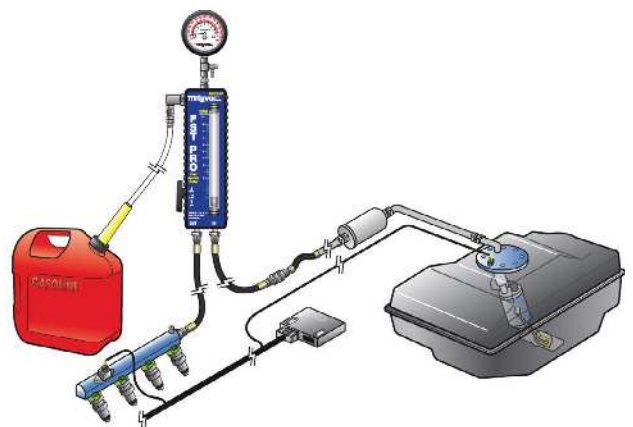

Fig. 30

reduce fuel spillage, whenever possible, try to select the required adapters before disconnecting the fuel line, and have them ready to install.

## Setting-up the FST Pro

Once the installation point has been determined, follow the instructions below to setup the tester prior to disconnecting the fuel line.

1. Place the vehicle transmission in park or neutral, apply the parking brake, and turn the key off.
2. Hang the pressure gauge under the vehicle hood or other appropriate location.
3. Connect the flowmeter to the pressure gauge using the female push-to-connect coupler extending from the bottom of the gauge, and the male connector located on top of the flowmeter. Make sure the quick-connect sleeve snaps forward to lock the connection.

NOTE: The flowmeter should hang vertically for the most accurate fuel flow measurement.

4. Connect the 1/8" (3 mm) clear pressure relief hose to the barb extending from the push-button pressure relief valve located just under the gauge (Fig. 31).
5. Place the free ends of the bypass hose and pressure relief hose into an approved gasoline fuel container. Secure hoses in fuel container as necessary to prevent spills.
6. Connect one end of each 3/8" inlet and outlet connection hoses to the bottom fittings on the FST flowmeter (Fig. 32).

## Installing the FST Pro

1. Be sure the vehicle transmission is in park or neutral, the parking brake is applied, and the engine is off.
2. Follow the vehicle manufacturer's recommended procedure to relieve the pressure from the vehicle fuel delivery system.
3. Locate the fuel supply line to the engine's fuel rail, and select the best location to disconnect the supply line and install the FST (Fig. 33). If uncertain of the proper connection point, see the previous section entitled Determining Where to Install the FST. For additional assistance, consult the vehicle manufacturer's service information, or refer to the Types of Fuel Delivery Systems section earlier in this manual.

If the engine has a cover, it will most likely have to be removed to gain appropriate access.

4. Remove or disconnect any obstacles required to gain access to the connection, and place shop towels under and around the connection to absorb fuel from the disconnected line.

To minimize fuel spillage and reduce the amount of time the fuel line is disconnected, try to identify the type of connection before disconnecting the fuel line, and have the required FST connection adapter(s) readily available (see Selecting and Installing Adapters above). Also, identify the inlet and outlet hoses to the tester, and keep them convenient.

5. Follow the vehicle manufacturer's service information for the proper method to disconnect the fuel line. Special wrenches or disconnect tools may be required (Fig. 34).

WARNING: Avoid spilling fuel on hot engine parts. Clean-up any fuel spills immediately after they occur.

6. Install the appropriate adapter into the fuel supply line extending from the tank (Fig. 35).



Fig. 31



Fig. 32



Fig. 33



Fig. 34



Fig. 35

7. Connect the hose extending from the flowmeter connection labeled "IN", to the other end of the adapter (Fig. 36).
8. Install the second FST connection adapter to the fuel line running to the fuel rail. If the fuel line connection used by the vehicle manufacturer is a 3/8" quick-connect style (SAE J2044), a second adapter is not required.
9. Connect the hose extending from the flowmeter connection labeled "OUT", to the other end of the adapter or directly to the fuel line running to the fuel rail, depending on the type of connection (Fig. 37).
10. Before proceeding:

Double check the connections. The tester should be installed such that the fuel flowing from the tank to the engine enters the FST through the port labeled "IN", out of the tester through the port labeled "OUT", and on to the fuel rail.

Route and secure the clear pressure relief and bypass hoses into an approved fuel container

Route the flowmeter inlet and outlet fuel hoses away from rotating engine components, belts, fans, and hot exhaust components

Remove the fuel spillage rags

Reconnect components such as PCV tubes, wiring harnesses, vacuum tubes, etc., that were disconnected to gain access to the fuel line connection.

Check the operating position of the flow control valve on the side of the flowmeter. Ensure it is in the OPEN position pointing down (Fig. 38).

11. Re-enable the fuel pump (if previously disabled), and cycle the ignition switch to the ON position for a brief time, and then back OFF. Do not start the engine.

On most vehicles, cycling the ignition ON and OFF will allow the fuel pump to run briefly, and prime the tester. After cycling the ignition, check all fuel connections for leaks. If all fitting connections are secure, the installation is complete and the FST Pro is ready to be used for diagnostic tests.



Fig. 36

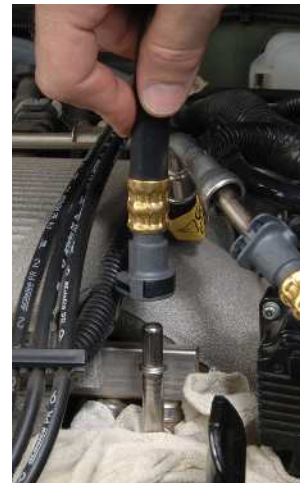

Fig. 37



Fig. 38

## Testing and Diagnostics

Testing and diagnostic procedures vary depending on the type of fuel delivery system. Prior to testing, the fuel delivery system must be identified as Return, Returnless (mechanically regulated) or Returnless (electronically regulated). For detailed information on fuel delivery systems and how to identify them, refer to the section entitled Types of Fuel Delivery Systems, earlier in this manual. If the fuel system is a return or mechanically regulated returnless system, it must also be determined if the fuel pump has multiple speeds. For more information on types of fuel pumps refer to Fuel System Components/Fuel Pump in this manual.

### Return Fuel Delivery Systems

At this point, it is assumed that the FST has been properly installed inline with the fuel delivery system as recommended, and that it has been primed to ensure no leaks are present (see Setup and Installation). The following procedure will ensure the most effective diagnostic use of the FST:

#### Test Procedure

##### Operational Test

1. Check the operating position of the flow control valve on the side of the flowmeter to ensure the knob is in the OPEN position pointing down (Fig. 39). This will allow normal fuel system operation.

2. Start the car and allow it to idle.

Cranking or starting the engine should activate the ECM's electric fuel pump controls to turn on and run the fuel pump. If the fuel pump does not operate, refer to the vehicle service information for electrical diagnosis and repair of the fuel pump and associated controls.

After connecting the FST, it is normal to have air trapped in the fuel lines and flowmeter. Cycling the ignition switch (or cranking the engine briefly) with the flow control valve in the BYPASS position can help purge air from the system. Once fuel fills the flowmeter and flows through the bypass hose, return the valve to the OPEN position. The bypass hose must be routed and secured into an approved fuel container before operating the flow control valve in BYPASS mode.

To perform an accurate diagnosis using the FST, the car must be running in order to provide the correct operating voltage to the fuel pump. Testing the fuel system by activating the fuel pump using a scan tool will cause the fuel pump to severely under-perform.

3. If the vehicle utilizes a multiple speed fuel pump, use a scanner or manufacturer's recommended procedure to operate the pump at the highest speed.
4. Note the fuel system pressure indicated on the pressure gauge, and compare it with the vehicle manufacturer's specification (Fig. 40).

Typical electronic fuel injection system pressures range from 30 to 60 PSI (205 to 410 kpa) depending on the vehicle being tested. Always use the recommended vehicle service information, procedures, and pressure specifications for the specific vehicle being tested.

5. Note the volume of fuel passing through the flowmeter by reading across the top of the float and comparing it to the corresponding value on the scale printed on the faceplate (Fig. 41).

At idle, the volume of fuel flowing through the tester should remain steady between 0.3 and 0.7 gallons per minute (GPM) or 1.1 and 2.6 liters per minute (LPM).

6. Noting the values for pressure and volume, if either is out of range,



Fig. 39



Fig. 40

Read top of float



Fig. 41

these are indications of a problem with one or more components of the fuel system. However, performing the Pressure and Flow Demand Tests below, is required to reach a more accurate diagnosis, and to pinpoint the cause of a malfunction.

#### Pressure Demand (Dead-head) Test

7. With the car idling, rotate the flow control valve on the side of the flowmeter towards the 90° CLOSED position (Fig. 42).

Rotating the valve to CLOSED creates a restriction to the flow of fuel through the tester. Watch the pressure gauge, as the valve is rotated, the pressure should increase. Note the pressure when the valve is fully closed. A good fuel pump should be capable of producing pressure 50% to 100% higher than the rating of the fuel system.

Caution: Never rotate the valve to the closed position for longer than a brief instant. This is referred to as "dead-heading" the pump, and can cause serious damage to the fuel system or pump.

8. After noting the peak pressure, rotate the flow control valve back to the OPEN position, and proceed to the flow demand test.

#### Flow Demand Test

9. With the car idling, rotate the flow control valve past the CLOSED position to the BYPASS position pointing up (Fig. 43).

With the valve in the BYPASS position, the flow of fuel is routed through the bypass port located above the valve, through the bypass hose, and into the reservoir. All restriction to the flow of fuel is removed. This allows the pump to output its maximum flow, the value of which can be read on the flowmeter. The free flow output of a typical fuel pump is between .7 and 1.0 GPM (2.6 and 4.0 LPM).

Note: Turning the valve to the full BYPASS position will prevent fuel from flowing to the engine. If left in the BYPASS position for too long, the engine will stall. If this happens, simply return the valve to the OPEN position and restart the vehicle.

10. After noting the peak flow, return the flow control valve to the OPEN position. Testing is complete.

#### Diagnosing the Results

The values for four critical fuel system performance indicators should have been noted while following the procedures and performing the tests outlined above:

- Idle Pressure
- Idle Flow
- Peak (Dead-head) Pressure
- Peak (Bypass) Flow

These indicators are the key to properly diagnosing a malfunctioning fuel delivery system, and pinpointing the cause. In addition to these values, note the vehicle's engine size and maximum engine speed (RPM). Refer to the Maximum Engine Fuel Volume Requirements table (Appendix A), and use the size and speed values to determine the maximum fuel volume requirement of the engine.

Refer to the Return Fuel System Diagnostic Guide (Appendix B). If according to the chart, the FST test values indicate a normal operating fuel delivery system, then the engine is receiving the proper pressure and flow of fuel, even under maximum load conditions. If the FST



Fig. 42



Fig. 43

indicates a normal operating fuel delivery system, yet the vehicle continues to experience symptoms of a fuel delivery malfunction, it could be caused by contaminated fuel, faulty fuel injector(s), or an intermittent component malfunction such as a sticking pressure regulator or loose electrical connection. Follow the vehicle manufacturer's recommended procedures for the inspection and repair of these components.

If the FST test results indicate a fuel delivery system malfunction, and the diagnostic chart clearly pinpoints the cause, follow the vehicle manufacturer's repair procedures to correct the malfunction. After performing the repairs, re-test the fuel delivery system with the FST to ensure it is operating normally.

If the FST test results are inconclusive as to whether there is a fuel delivery system malfunction, or if a malfunction is evident but the diagnostic chart does not clearly indicate the cause, additional testing may be performed to provide more insight into the performance of the system. Extended test procedures are outlined below, and provide a more in-depth understanding of how the components of the fuel system affect its performance.

### Additional Testing and Diagnostics

To perform more in-depth diagnostics, consider the fuel delivery system split into three zones as shown in figure 44. The initial test procedures outlined above are performed in Zone 2 because the fuel pressure and flow within this zone, most accurately represent the conditions present in the fuel rail. Depending on the suspected component malfunction, connecting the FST in either Zone 1 or Zone 3 and comparing the test results to those in Zone 2 can help pinpoint a malfunction.

#### Blocked Inline Fuel Filter

If the inline filter is clean, pressure and flow in Zones 1 and 2 should be equal. A clogged filter will cause the pressure to increase in Zone 1 and the flow to decrease in Zone 2.

If the results of testing in Zone 2 indicate a blocked fuel filter, but are not entirely conclusive, retest the fuel system with the FST connected in Zone 1, preferably at the inlet of the fuel filter. If the idle pressure and the peak flow in Zone 1 are higher than Zone 2, replace the inline fuel filter and retest.

If the idle pressure and peak flow in Zone 1 remain the same as Zone 2, this would indicate a clogged inlet strainer/sock.

#### Clogged Inlet Strainer/Sock

The test results for pressure and flow of a clogged inlet strainer will closely match those of a clogged inline filter. The peak pressure of a clogged inlet strainer will be slightly lower than the peak pressure of a clogged inline filter, and the current draw will also be lower.

A clogged inlet strainer can cause the fuel pump to cavitate because it is starved for fuel. Cavitation will create rapid changes in fuel density, causing the float in the FST flowmeter to bounce up and down. It can also cause the needle on the pressure gauge to bounce. Also, as the pump tries to pull gas through the clogged strainer, it creates a pressure drop that may cause air bubbles to form and become visible.

These indications of a clogged inlet strainer may or may not be evident during testing. If the results are inconclusive, retest the fuel system with the FST connected in Zone 1, preferably at the inlet of the fuel filter.

If the idle pressure and peak flow in Zone 1 remain the same as Zone 2, this would indicate a clogged inlet strainer/sock. Replace the strainer or the pump module, and retest.

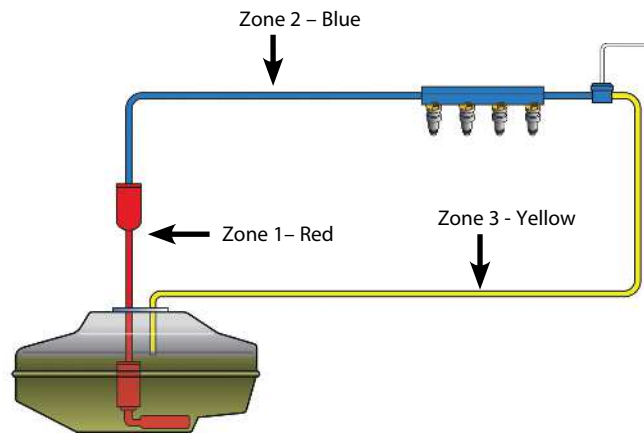

Fig. 44



---

#### Faulty Fuel Pressure Regulator (Low Pressure)

A pressure regulator that does not sufficiently restrict fuel flow will cause the idle pressure in Zones 1 and 2 to drop below spec, and the idle flow to be higher than normal. If this is what the FST is indicating, and the peak pressure and flow are normal, then the cause is most certainly the pressure regulator.

If the fuel pressure regulator is vacuum modulated (see Fuel System Components/Pressure Regulator), it is possible to check if it is sticking by disconnecting the vacuum line. If the regulator is functioning properly, disconnecting the vacuum line should cause the fuel pressure to increase.

#### Faulty Fuel Pressure Regulator (High Pressure)

If Zone 2 testing indicates idle pressure is high and flow is low, yet peak pressure and flow are normal, this is a clear indication of too much restriction in Zone 3. Over-restriction can be caused by a malfunctioning fuel pressure regulator or blockage in the return fuel line.

Perform a careful visual inspection of the fuel return line to ensure it's not crushed, dented or kinked. Plastic and rubber fuel lines can easily kink, restricting fuel flow. Check for clamps that might have been over tightened to the point they crushed the fuel line. Also check all connectors for damage that could cause a restriction. If damage or restriction is noted, repair the line and retest.

Inspect the fuel pressure regulator for physical damage. Also look for dampness that could indicate a ruptured diaphragm that is leaking fuel. Replace and retest if necessary.

If the pressure regulator is vacuum modulated, use a vacuum gauge to verify the vacuum reading at the regulator. A below normal vacuum reading would cause the regulator to over-restrict the flow. Follow the vehicle manufacturer's procedure for locating and repairing the cause of the vacuum loss, and retest.

If vacuum is normal, connect the FST in Zone 3, preferably right after the pressure regulator. Test the fuel system at this point, and compare the results to Zone 2. The pressure in Zone 3 should be very low. If it remains high, there is a restriction in the fuel return line. If the pressure drops off to near zero, then replace the fuel pressure regulator.

#### Fuel Pump Malfunction

A malfunction at the fuel pump is typically indicated by a reduction in both pressure and flow. At idle, the regulator may be able to maintain pressure in Zones 1 and 2, but doing so will severely reduce the flow. Performing pressure and flow demand tests should clearly indicate a pump problem.

If the FST indicates a pump is under performing, be sure to verify that the vehicle does not use a multiple speed pump (see Fuel System Components/Fuel Pump). To properly test a fuel system with a multiple speed pump, a scanner must be used to operate the pump at high speed while the vehicle idles.

NOTE: Insufficient pressure and flow are an indication that a fuel pump is under-performing, but do not necessarily mean that it is failing. Low voltage or a bad connection or ground will cause a pump to under-perform, producing the same test results as if the pump were bad. Before replacing any fuel pump based on the FST test results, always follow the vehicle manufacturer's recommended procedure for testing all electrical connections and the electrical system charge. A minor issue such as a loose ground can cause many problems that resemble more serious malfunctions.

## Returnless Fuel Delivery Systems (Mechanically Regulated)

At this point, it is assumed that the FST has been properly installed inline with the fuel delivery system as recommended, and that it has been primed to ensure no leaks are present (See FST Pro Setup and Installation). The following procedure will ensure the most effective diagnostic use of the FST:

### Test Procedure

#### Operational Test

1. Check the operating position of the flow control valve on the side of the flowmeter to ensure the knob is in the OPEN position pointing down (Fig. 45). This will allow normal fuel system operation.

2. Start the car and allow it to idle.

Cranking or starting the engine should activate the ECM's electric fuel pump controls to turn on and run the fuel pump. If the fuel pump does not operate, refer to the vehicle service information for electrical diagnosis and repair of the fuel pump and associated controls.

After connecting the FST, it is normal to have air trapped in the fuel lines and flowmeter. Cycling the ignition switch (or cranking the engine briefly) with the flow control valve in the BYPASS position can help purge air from the system. Once fuel fills the flowmeter and flows through the bypass hose, return the valve to the OPEN position. The bypass hose must be routed and secured into an approved fuel container before operating the flow control valve in BYPASS mode.

To perform an accurate diagnosis using the FST, the car must be running in order to provide the correct operating voltage to the fuel pump. Testing the fuel system by activating the fuel pump using a scan tool, will cause the fuel pump to severely under-perform.

3. If the vehicle utilizes a multiple speed fuel pump, use a scanner or manufacturer's recommended procedure to operate the pump at the highest speed.
4. Note the fuel system pressure indicated on the pressure gauge, and compare it with the vehicle manufacturer's specification (Fig. 46). If it is out of spec, this is an indication of a problem with one or more components of the fuel system. However, performing a Flow Demand Test and Peak Demand Test as outlined below, are required to reach an accurate diagnosis of the fuel system and to pinpoint the cause of the malfunction.

NOTE: The flow of fuel passing through the tester represents only what the engine is using at idle. It will be negligible and most likely not even register on the flowmeter.

#### Flow Demand Test

5. With the car idling, rotate the flow control valve past the CLOSED position to the BYPASS position pointing up (Fig. 47).

With the valve in the BYPASS position, the flow of fuel is routed through the bypass port located above the valve, through the bypass hose, and into the reservoir. All restriction to the flow of fuel is removed. This allows the pump to output its maximum flow, the value of which can be read on the flowmeter. The free flow output of a typical fuel pump is between .7 and 1.0 GPM (2.5 and 4.0 LPM).

NOTE: Turning the valve to the CLOSED or BYPASS position will prevent fuel from flowing to the engine. If left in either of these positions for too long, the engine will stall. If this happens, simply return the valve to the OPEN position and restart the vehicle.

6. After noting the peak flow, return the flow control valve to the OPEN position.



Fig. 45



Fig. 46



Fig. 47

### Peak Demand Test

- Note the vehicle's engine size and maximum engine speed (RPM). Refer to the Maximum Engine Fuel Volume Requirements table (Appendix A), and use the size and speed values to determine the maximum fuel volume requirement of the engine.
- With the car idling, rotate the flow control valve past the 90° CLOSED position towards BYPASS (Fig. 48). Adjust the valve until the flowmeter indicates an amount of fuel flow equivalent to the value for the maximum engine fuel volume taken from the table (Fig. 49).
- Note the pressure reading on the gauge.
- After noting the capability pressure, return the flow control valve to the OPEN position. Testing is complete.

### Diagnosing the Results

The values for three critical fuel system performance indicators should have been noted while following the procedures and performing the tests outlined above:

- Idle Pressure
- Peak (Bypass) Flow
- Peak Demand Pressure

These indicators are the key to properly diagnosing a malfunctioning fuel delivery system, and pinpointing the cause.

Compare the three values to the Returnless (mechanically regulated) Fuel System Diagnostics Chart (Appendix C). If according to the chart, the FST test values indicate a normal operating fuel delivery system, then the engine is receiving the proper pressure and flow of fuel, even under maximum load conditions. If the FST indicates a normal operating fuel delivery system, yet the vehicle continues to experience symptoms of a fuel delivery malfunction, it could be caused by contaminated fuel, faulty fuel injector(s), or an intermittent component malfunction such as a sticking pressure regulator or loose electrical connection.

If the FST test results are inconclusive as to whether there is a fuel delivery system malfunction, or if a malfunction is evident but the diagnostic chart does not clearly indicate the cause, additional testing may be performed to provide more insight into the performance of the system. Extended test procedures are outlined below, and provide a more in-depth understanding of how the components of the fuel system affect its performance.

### Additional Testing and Diagnostics

#### Blocked Inline Fuel Filter

Not all mechanically regulated returnless fuel systems utilize an externally mounted fuel filter (see Types of Fuel Delivery Systems/ Mechanically Regulated). If the vehicle has an accessible fuel filter, and initial test results indicate it may be partially blocked, retest the fuel system with the FST connected at the inlet of the fuel filter. If the peak flow and peak demand pressure are higher than in the initial test, replace the fuel filter and retest. If the peak flow and peak demand pressure remain the same, this would indicate a clogged inlet strainer/sock.

#### Clogged Inlet Strainer/Sock

The test results for pressure and flow of a clogged inlet strainer will closely match those of a clogged inline filter. The peak demand pressure of a clogged inlet strainer will be slightly lower than that of a clogged inline filter, and the current draw will also be lower.



Fig. 48



Maximum fuel volume requirement (Appendix A)

Fig. 49

A clogged inlet strainer can cause the fuel pump to cavitate because it is starved for fuel. Cavitation will create rapid changes in fuel density, causing the float in the FST flowmeter to bounce up and down during the peak flow and/or peak demand test. It can also cause the needle on the pressure gauge to bounce. In addition, as the pump tries to pull fuel through the clogged strainer, it creates a pressure drop that may cause air bubbles to form and become visible.

These indications of a clogged inlet strainer may or may not be evident during testing. If the results are inconclusive, and the fuel system has an accessible inline filter, follow the procedure above to rule out a clogged filter. If it is determined that the inline filter is not the problem, replace the strainer or the pump module, and retest.

#### Faulty Pressure Regulator (Low or High Pressure)

Because mechanically regulated returnless fuel systems incorporate the pressure regulator into the fuel pump module, it is not possible to perform additional on-car testing to determine if the pressure regulator is malfunctioning. If the pressure regulator and/or fuel pump is replaceable within the module, the FST test results may be beneficial in determining how to approach a repair.

#### Fuel Pump Malfunction

A malfunction at the fuel pump is typically indicated by a reduction in both pressure and flow. At idle, the regulator may be able to maintain pressure in the system, but the pressure will drop as soon as the engine requires a greater volume of fuel. Performing flow demand and peak demand tests should clearly indicate a pump problem.

If the FST indicates a pump is under performing, be sure to verify that the vehicle does not use a multiple speed pump (see Fuel System Components/ Fuel Pumps). To properly test a fuel system with a multiple speed pump, a scanner must be used to operate the pump at high speed while the vehicle idles.

NOTE: Insufficient pressure and flow are an indication that a fuel pump is under-performing, but do not necessarily mean that it is failing. Low voltage or a bad connection or ground will cause a pump to under-perform, producing the same test results as if the pump were bad. Before replacing any fuel pump based on the FST test results, always follow the vehicle manufacturer's recommended procedure for testing all electrical connections and the electrical system charge. A minor issue such as a loose ground can cause many problems that resemble more serious malfunctions.

## Returnless Fuel Delivery Systems (Electronically Regulated)

At this point, it is assumed that the FST has been properly installed inline with the fuel delivery system as recommended, and that it has been primed to ensure no leaks are present (see FST Pro Setup and Installation). The following procedure will ensure the most effective diagnostic use of the FST:

#### Operational Test

1. Check the operating position of the flow control valve on the side of the flowmeter to ensure the knob is in the OPEN position pointing down (Fig. 50). This will allow normal fuel system operation.
2. Start the car and allow it to idle.

Cranking or starting the engine should activate the ECM's electric fuel pump controls to turn on and run the fuel pump. If the fuel pump does not operate, refer to the vehicle service information for electrical diagnosis and repair of the fuel pump and associated controls.

After connecting the FST, it is normal to have air trapped in the fuel



Fig. 50

lines and flowmeter. Cycling the ignition switch (or cranking the engine briefly) with the flow control valve in the BYPASS position can help purge air from the system. Once fuel fills the flowmeter and flows through the bypass hose, return the valve to the OPEN position. The bypass hose must be routed and secured into an approved fuel container before operating the flow control valve in BYPASS mode.

To perform an accurate diagnosis using the FST, the car must be running in order to provide the correct operating voltage to the fuel pump. Testing the fuel system by activating the fuel pump using a scan tool will cause the fuel pump to severely underperform.

3. Note the fuel system pressure indicated on the pressure gauge, and compare it with the vehicle manufacturer's specification (Fig. 51).

Typical electronic fuel injection system pressures range from 30 to 60 PSI (205 to 410 kpa) depending on the vehicle being tested. Always use the recommended vehicle service information, procedures, and pressure specifications for the specific vehicle being tested.

NOTE: The flow of fuel passing through the tester represents only what the engine is using at idle. It will be negligible and most likely not even register on the flowmeter.

#### Pressure Demand (Dead-head) Test

4. With the car idling, rotate the flow control valve on the side of the flowmeter towards the 90° CLOSED position (Fig. 52).

Rotating the valve to CLOSED creates a restriction to the flow of fuel through the tester. Watch the pressure gauge, as the valve is rotated, the pressure should increase. Note the pressure when the valve is fully closed. A good fuel pump should be capable of producing pressure 50% to 100% higher than the rating of the fuel system.

Caution: Never rotate the valve to the closed position for longer than a brief instant. This is referred to as "dead-heading" the pump, and can cause serious damage to the fuel system or pump.

5. After noting the peak pressure, rotate the flow control valve back to the OPEN position, and proceed to the flow demand test.

#### Flow Demand Test

6. With the car idling, rotate the flow control valve past the CLOSED position to the BYPASS position pointing up (Fig. 53).

With the valve in the BYPASS position, the flow of fuel is routed through the bypass port located above the valve, through the bypass hose, and into the reservoir. All restriction to the flow of fuel is removed. This allows the pump to output its maximum flow, the value of which can be read on the flowmeter. The free flow output of a typical fuel pump is between .7 and 1.0 GPM (2.5 and 4.0 LPM).

NOTE: Turning the valve to the full BYPASS position will prevent fuel from flowing to the engine. If left in the BYPASS position for too long, the engine will stall. If this happens, simply return the valve to the OPEN position and restart the vehicle.

7. After noting the peak pressure, return the flow control valve to the OPEN position, and proceed to the peak demand test.

#### Peak Demand Test

8. Note the vehicle's engine size and maximum engine speed (RPM). Refer to the Maximum Engine Fuel Volume Requirements table (Appendix A), and use the size and speed values to determine the maximum fuel volume requirement of the engine.
9. With the car idling, rotate the flow control valve past the 90° CLOSED position towards BYPASS (Fig. 54). Adjust the valve until the flowmeter indicates an amount of fuel flow equivalent to the value for the maxi-



Fig. 51



Fig. 52



Fig. 53

imum engine fuel volume taken from the table (Fig. 55).

10. Note the pressure reading on the gauge.
11. After noting the peak demand pressure, return the flow control valve to the OPEN position. Testing is complete.

### Diagnosing the Results

The values for four critical fuel system performance indicators should have been noted while following the procedures and performing the tests outlined above:

- Idle Pressure
- Peak Demand Pressure
- Peak (Dead-head) Pressure
- Peak (Bypass) Flow

These indicators are the key to properly diagnosing a malfunctioning fuel delivery system, and pinpointing the cause.

Compare the four values to the Returnless (electronically regulated) Fuel System Diagnostic Chart (Appendix D). If according to the chart, the FST test values indicate a normal operating fuel delivery system, then the engine is receiving the proper pressure and flow of fuel, even under maximum load conditions. If the FST indicates a normal operating fuel delivery system, yet the vehicle continues to experience symptoms of a fuel delivery malfunction, it could be caused by contaminated fuel, faulty fuel injector(s) or electronic control system, or an intermittent component malfunction such as a loose electrical connection.

If the FST test results indicate a fuel delivery system malfunction, and the diagnostic chart clearly pinpoints the cause, follow the vehicle manufacturer's repair procedures to correct the malfunction. After performing the repairs, re-test the fuel delivery system with the FST to ensure it is operating normally.

If the FST test results are inconclusive as to whether there is a fuel delivery system malfunction, or if a malfunction is evident but the diagnostic chart does not clearly indicate the cause, additional testing may be performed to provide more insight into the performance of the system. Extended test procedures are outlined below, and provide a more in-depth understanding of how the components of the fuel system affect its performance.

### Additional Testing and Diagnostics

#### Blocked Inline Fuel Filter

If the vehicle has an accessible fuel filter, and initial test results indicate it may be partially blocked, retest the fuel system with the FST connected between the fuel tank and the filter, preferably at the filter inlet. If the peak flow and peak demand pressure are higher than in the initial test, replace the fuel filter and retest. If the peak flow and peak demand pressure remain the same, this would indicate a clogged inlet strainer/sock.

#### Clogged Inlet Strainer/Sock

The test results for pressure and flow of a clogged inlet strainer will closely match those of a clogged inline filter. The peak demand pressure of a clogged inlet strainer will be slightly lower than that of a clogged inline filter, and the current draw will also be lower.

A clogged inlet strainer can cause the fuel pump to cavitate because it is starved for fuel. Cavitation will create rapid changes in fuel density, causing the float in the FST flowmeter to bounce up and down during the peak flow and/or peak demand test. It can also cause the needle on the pressure gauge to bounce. In addition, as the pump tries to pull fuel through the clogged strainer, it creates a pressure drop that may cause air bubbles to form and become visible.



Fig. 54



Maximum fuel volume requirement (Appendix A)

Fig. 55

---

These indications of a clogged inlet strainer may or may not be evident during testing. If the results are inconclusive, and the fuel system has an accessible inline filter, follow the procedure above to rule out a clogged filter. If it is determined that the inline filter is not the problem, replace the strainer or the pump module, and retest.

#### Fuel Pump/Electronic Control Failure

If testing with the FST indicates the engine is not receiving the proper fuel pressure and volume, and a clogged inline filter or fuel line are determined not to be the cause, then a failure of the electronic control system or the fuel pump is the most likely cause. Follow the vehicle manufacturer's recommended procedure for troubleshooting these components to determine the malfunction. Once repairs are complete, retest the system for proper fuel delivery system performance.

### Fuel Visualization

Visualizing the fuel as it passes through the flowmeter can provide hints of fuel system problems or fuel contamination. A rapid drop in pressure possibly caused by a clogged inlet strainer can cause the fuel to boil, even at normal temperatures. Air released by the fuel forms bubbles that are visible as they pass through the flowmeter.

Air bubbles can also be caused by a bad swirl pot or leaking fuel pickup line in the tank, which allow air to be sucked into the fuel pump. Performing flow demand tests can sometimes cause air to form in the fuel lines, but air bubbles should never be present once the FST is connected, air is bled off, and fuel is flowing normally to the engine.

Fuel contaminated with water may appear discolored or cloudy. Rust or scale will typically be filtered out before reaching the tester, but additives can cause discoloration. Don't be fooled by fuel that appears normal. Many chemical impurities are not visible, but can cause the engine to run poorly.

### Pressure Leakdown Test

To facilitate hot starts, modern fuel delivery systems should maintain some pressure for several hours after the engine is turned off. Once the fuel pump is no longer operating, the pressure is trapped in the fuel system by a check valve in the fuel pump, and closing of the pressure regulator and fuel injectors.

With the FST connected inline, before the fuel rail, turn off the engine and watch the pressure gauge. If the pressure drops more than 5 psi in 5 minutes, a leak exists somewhere in the system.

#### Return Fuel Systems

1. Start the engine to build pressure.
2. Turn off the engine and immediately clamp off the FST outlet hose running from the tester to the fuel rail. This will trap the pressure gauge between the clamp and the fuel pump.
3. If the pressure gauge indicates a leak, check the fuel supply line from the tank to the tester. If no leaks are evident, replace the fuel pump due to a faulty check valve.
4. Remove the clamp from the fuel line, and restart the engine to build pressure.
5. Turn off the engine and immediately clamp off the FST inlet hose running to the tester from the fuel supply line. This will trap the pressure gauge between the clamp, the fuel rail, the pressure regulator, and the fuel return line.
6. If the pressure drops, either the injectors or the pressure regulator is leaking.

7. With the second scissor clamp, pinch off the fuel return line between the pressure regulator and the fuel tank.
8. If the pressure continues to drop, the cause is a leaking injector(s). If the pressure holds steady, the cause is a leaking pressure regulator.

### Returnless Fuel Systems

1. Start the engine to build pressure.
2. Turn off the engine and immediately clamp off the FST outlet hose running from the tester to the fuel rail. This will trap the pressure gauge between the clamp and the fuel pump module.
3. If the pressure gauge indicates a leak, check the fuel supply line from the tank to the tester. If no leaks are evident, replace the fuel pump module due to a faulty pump check valve or leaking regulator.
4. Remove the clamp from the fuel line, and restart the engine to build pressure.
5. Turn off the engine and immediately clamp off the FST inlet hose running to the tester from the fuel supply line. This will trap the pressure gauge between the clamp and the fuel rail.
6. If the pressure drops, the cause is a leaking injector(s).

### Disconnecting the FST

The FST Pro contains features and components to safely disconnect with a minimal release of fuel. Follow the procedures below and always observe the safety precautions listed in the front of this manual. Carefully read the warning below concerning disconnecting from a hot returnless fuel system.

1. When vehicle testing is completed, turn off engine and relieve pressure on the fuel system by pressing the pressure relief valve located on the stem of the pressure gauge (Fig. 56). Watch the pressure gauge readings and fuel being released through the small clear hose to the collecting container.

The flow control valve must remain in the OPEN position during pressure relief. When fuel pressure is not shown on the gauge, and fuel stops flowing through the relief hose, proceed to step 2.

2. Place shop towels under the connections to capture any fuel that may spill out when the hoses are disconnected.
3. Using the two scissor hose clamps supplied in the FST Pro kit, clamp both of the connecting hoses near the end where they connect to the vehicle's fuel system (Fig. 57). Lock them securely to prevent fuel from leaking out of the tester when the hoses are disconnected.

**WARNING:** After testing a returnless fuel system, use extreme caution when disconnecting the outlet hose connecting the FST to the fuel rail. If the engine is hot, releasing the pressure from a returnless fuel system will cause the fuel to boil in the fuel rail. Even though the pressure has been released, the boiling fuel will cause it to build up again once the hose is clamped. To reduce the risk of fuel spray it is best to allow the engine to cool before disconnecting the hose. Otherwise, use the FST pressure relief valve to relieve the pressure just before clamping the hose. Once the hose is clamped, quickly disconnect the hose from the fuel system before the pressure has time to build. Try to keep a shop towel wrapped around the connection to catch any fuel spray.

4. Rotate the flow control valve to the CLOSED position to help prevent fuel leakage.
5. With the scissor clamps locked in place on the connecting hoses, disconnect the FST adapters and fitting connectors from the



Fig. 56



Fig. 57



vehicle's fuel system (Fig. 58).

6. Reconnect the vehicle fuel lines and check for possible fuel connection leaks before starting the engine (Fig. 59). Cycling the ignition ON and OFF without starting the engine, will run the fuel pump briefly to prime the fuel system on most vehicles. Always check fuel line connections to ensure they are securely fastened and do not leak.
7. Place the disconnected ends of the connection hoses into an approved fuel container with the bypass and pressure relief hoses. Drain fuel from the FST flowmeter, gauge and hoses by releasing the scissor clamps. Rotate the flow control valve and press the pressure relief valve as necessary to ensure all fuel is drained from the tester.
8. Use the plastic hose plugs supplied in the FST kit, to temporarily cap the open ends of the flowmeter connecting hoses (Fig. 60).
9. If testing is complete, disassemble and store all components of the FST Pro in the original case.



Fig. 58

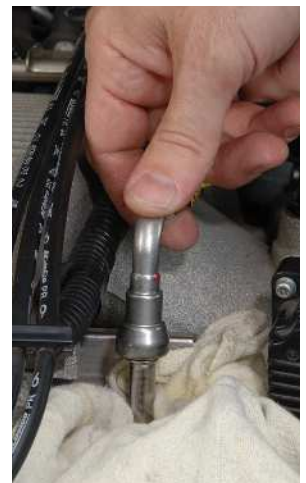

Fig. 59



Fig. 60

## Appendix A

### Maximum Engine Fuel Volume Requirements (Gallons/Minute)

Engine Size		Engine Speed (RPM)					
liters	CID	3000	4000	5000	6000	7000	8000
1.0	61	0.05	0.06	0.07	0.09	0.10	0.12
1.2	73	0.06	0.07	0.09	0.11	0.12	0.14
1.4	85	0.06	0.08	0.10	0.12	0.15	0.17
1.6	98	0.07	0.10	0.12	0.14	0.17	0.19
1.8	110	0.08	0.11	0.13	0.16	0.19	0.21
2.0	122	0.09	0.12	0.15	0.18	0.21	0.24
2.2	134	0.10	0.13	0.16	0.20	0.23	0.26
2.4	146	0.11	0.14	0.18	0.21	0.25	0.29
2.6	159	0.12	0.15	0.19	0.23	0.27	0.31
2.8	171	0.12	0.17	0.21	0.25	0.29	0.33
3.0	183	0.13	0.18	0.22	0.27	0.31	0.36
3.2	195	0.14	0.19	0.24	0.29	0.33	0.38
3.4	207	0.15	0.20	0.25	0.30	0.35	0.40
3.6	220	0.16	0.21	0.26	0.31	0.36	0.42
3.8	232	0.17	0.23	0.28	0.34	0.40	0.45
4.0	244	0.18	0.24	0.30	0.36	0.42	0.48
4.2	256	0.19	0.25	0.31	0.37	0.44	0.50
4.4	268	0.20	0.26	0.33	0.39	0.46	0.52
4.6	281	0.20	0.27	0.34	0.41	0.48	0.55
4.8	293	0.21	0.29	0.36	0.43	0.50	0.57
5.0	305	0.22	0.30	0.37	0.45	0.52	0.59
5.2	317	0.23	0.31	0.39	0.46	0.54	0.62
5.4	330	0.24	0.32	0.40	0.48	0.56	0.64
5.6	342	0.25	0.33	0.42	0.50	0.58	0.66
5.8	354	0.26	0.35	0.43	0.52	0.60	0.69
6.0	366	0.27	0.36	0.45	0.53	0.62	0.71
6.2	378	0.28	0.37	0.46	0.55	0.64	0.71
6.4	391	0.29	0.38	0.48	0.57	0.66	0.76
6.6	403	0.29	0.39	0.49	0.59	0.69	0.78
6.8	415	0.30	0.40	0.50	0.61	0.71	0.81
7.0	427	0.31	0.42	0.52	0.62	0.73	0.83
7.2	439	0.32	0.43	0.53	0.64	0.75	0.85
7.4	452	0.33	0.44	0.55	0.66	0.77	0.88
7.6	464	0.34	0.45	0.56	0.68	0.79	0.90
7.8	476	0.35	0.46	0.58	0.70	0.81	0.93
8.0	488	0.36	0.48	0.59	0.71	0.83	0.95
8.2	500	0.36	0.49	0.61	0.73	0.85	0.97
8.4	513	0.37	0.50	0.62	0.75	0.87	1.00

Values for maximum engine fuel volume requirements are calculated for normally aspirated combustion engines operating at 100% efficiency. Turbo- or super-charged engines will increase volume requirements, while other modifications and inefficiencies may reduce requirements. However, our research and testing supports these values as accurate approximations of maximum volume requirements.

## Appendix A

### Maximum Engine Fuel Volume Requirements (Liters/Minute)

Engine Size		Engine Speed (RPM)					
liters	CID	3000	4000	5000	6000	7000	8000
1.0	61	0.19	0.23	0.26	0.34	0.38	0.45
1.2	73	0.23	0.26	0.34	0.42	0.45	0.53
1.4	85	0.23	0.30	0.38	0.45	0.57	0.64
1.6	98	0.26	0.38	0.45	0.53	0.64	0.72
1.8	110	0.30	0.42	0.49	0.61	0.72	0.79
2.0	122	0.34	0.45	0.57	0.68	0.79	0.91
2.2	134	0.38	0.49	0.61	0.76	0.87	0.98
2.4	146	0.42	0.53	0.68	0.79	0.95	1.10
2.6	159	0.45	0.57	0.72	0.87	1.02	1.17
2.8	171	0.45	0.64	0.79	0.95	1.10	1.25
3.0	183	0.49	0.68	0.83	1.02	1.17	1.36
3.2	195	0.53	0.72	0.91	1.10	1.25	1.44
3.4	207	0.57	0.76	0.95	1.14	1.32	1.51
3.6	220	0.61	0.79	0.98	1.17	1.36	1.59
3.8	232	0.64	0.87	1.06	1.29	1.51	1.70
4.0	244	0.68	0.91	1.14	1.36	1.59	1.82
4.2	256	0.72	0.95	1.17	1.40	1.67	1.89
4.4	268	0.76	0.98	1.25	1.48	1.74	1.97
4.6	281	0.76	1.02	1.29	1.55	1.82	2.08
4.8	293	0.79	1.10	1.36	1.63	1.89	2.16
5.0	305	0.83	1.14	1.40	1.70	1.97	2.23
5.2	317	0.87	1.17	1.48	1.74	2.04	2.35
5.4	330	0.91	1.21	1.51	1.82	2.12	2.42
5.6	342	0.95	1.25	1.59	1.89	2.20	2.50
5.8	354	0.98	1.32	1.63	1.97	2.27	2.61
6.0	366	1.02	1.36	1.70	2.01	2.35	2.69
6.2	378	1.06	1.40	1.74	2.08	2.42	2.69
6.4	391	1.10	1.44	1.82	2.16	2.50	2.88
6.6	403	1.10	1.48	1.85	2.23	2.61	2.95
6.8	415	1.14	1.51	1.89	2.31	2.69	3.07
7.0	427	1.17	1.59	1.97	2.35	2.76	3.14
7.2	439	1.21	1.63	2.01	2.42	2.84	3.22
7.4	452	1.25	1.67	2.08	2.50	2.91	3.33
7.6	464	1.29	1.70	2.12	2.57	2.99	3.41
7.8	476	1.32	1.74	2.20	2.65	3.07	3.52
8.0	488	1.36	1.82	2.23	2.69	3.14	3.60
8.2	500	1.36	1.85	2.31	2.76	3.22	3.67
8.4	513	1.40	1.89	2.35	2.84	3.29	3.79

Values for maximum engine fuel volume requirements are calculated for normally aspirated combustion engines operating at 100% efficiency. Turbo- or super-charged engines will increase volume requirements, while other modifications and inefficiencies may reduce requirements. However, our research and testing supports these values as accurate approximations of maximum volume requirements.

## Appendix B – Return Fuel System Diagnostic Guide

Results Scenario	Idle Pressure	Idle Flow		Peak Pressure (CLOSED)		Peak Flow (BYPASS)		Potential Causes
1	Normal	Normal	Greater than maximum fuel volume requirement*	Normal	50% to 100% higher than spec	Normal	.7 to 1.0 GPM (2.5 to 4.0 LPM)	Fuel system is operating normally
2	Normal to slightly low	Low	Less than maximum fuel volume requirement*	Normal	50% to 100% higher than spec	Low	Less than .7 GPM (2.5 LPM)	Blocked fuel filter, inlet strainer or pinched supply line
3	Low	High	Greater than .7 GPM (2.5 LPM)	Normal	50% to 100% higher than spec	Normal	.7 to 1.0 GPM (2.5 to 4.0 LPM)	Faulty pressure regulator (low pressure)
4	High	Low	Less than maximum fuel volume requirement*	Normal	50% to 100% higher than spec	Normal	.7 to 1.0 GPM (2.5 to 4.0 LPM)	Faulty pressure regulator (high pressure)
5	Low	Low	Less than maximum fuel volume requirement*	Low	Less than 50% higher than spec	Low	Less than .7 GPM (2.5 LPM)	Failing fuel pump or insufficient power supply

\*See Appendix A for maximum engine fuel volume requirement

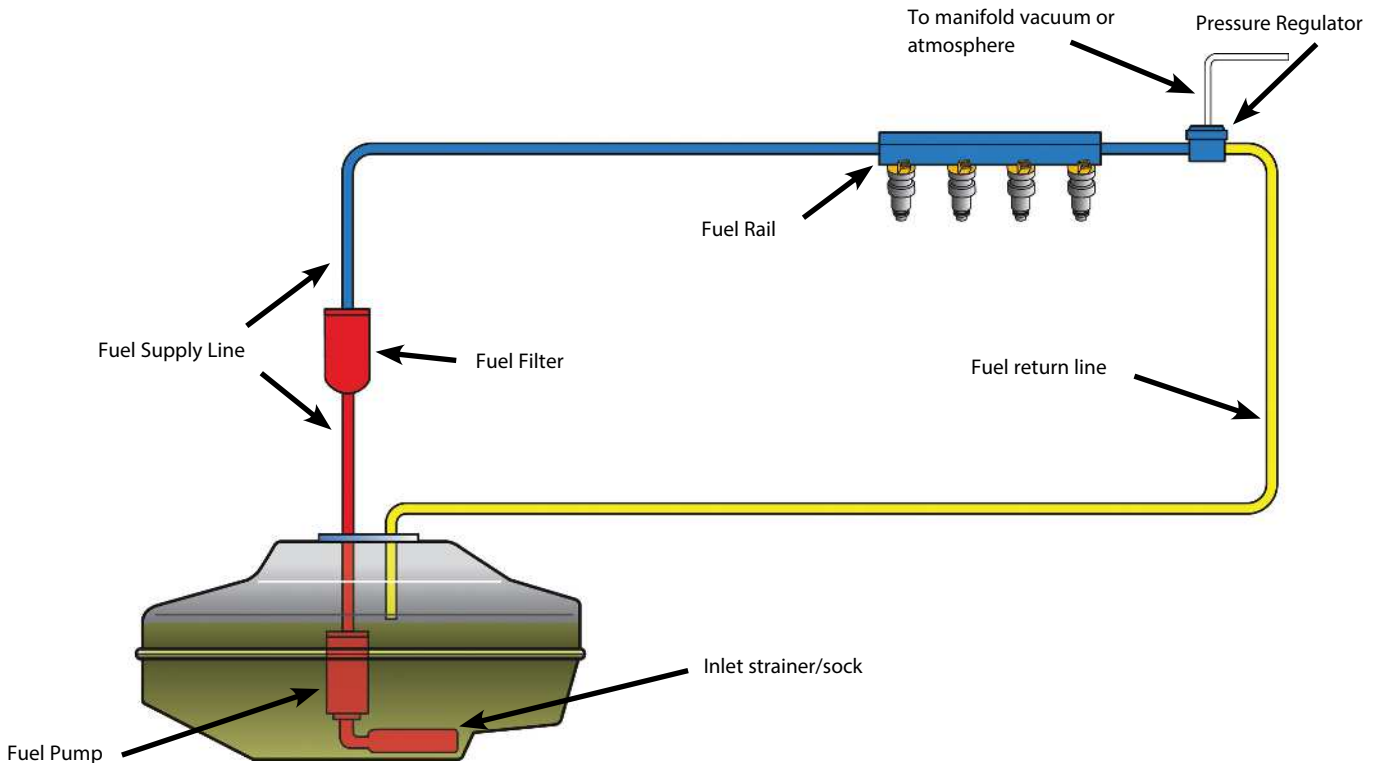

---

## Appendix B

### Return Fuel System Diagnostic Guide

#### Scenario 2

**Diagnosis:**

A restriction to the supply of fuel to the engine such as a clogged inlet strainer, inline filter, or pinched fuel supply line will reduce the flow of fuel. However, pressure will remain normal or drop only 1 or 2 psi below spec. If the flow at idle is less than the calculated maximum fuel volume requirement, then the engine will be starved of fuel in a heavy-load condition such as wide-open throttle.

**Additional Action:**

Inspect the fuel supply line for damage. Connect FST between fuel tank and inline filter, and retest. If flow is normal, replace inline filter. If flow is still low replace inlet strainer/sock.

#### Scenario 3

**Diagnosis:**

High flow and low pressure at idle are a sure indication of an under-restricting pressure regulator. If values for peak pressure and flow remain normal, replace the pressure regulator.

#### Scenario 4

**Diagnosis:**

High pressure and low flow at idle indicates too much restriction in the path of the fuel as it returns from the fuel rail to the fuel tank. The cause can be an over-restricting pressure regulator or pinched return line.

**Additional Action:**

Inspect the fuel return line for damage. If the regulator is vacuum modulated, check the level of vacuum at the regulator. If it is low, repair the cause. Connect the FST after the pressure regulator and retest. If pressure remains high, the return line is restricted. If it drops off to near zero, replace the pressure regulator.

#### Scenario 5

**Diagnosis:**

Low values for idle and peak pressure and flow are an indication that the output of the fuel pump is not adequate.

**Additional Action:**

Verify that the vehicle is not using a multiple speed pump. If so, a scanner must be used to operate the pump at its highest speed. Before replacing pump, follow the vehicle manufacturer's proper procedure to check for low voltage or a bad connection or ground.

## Appendix C – Returnless (mechanically regulated) Fuel System Diagnostic Guide

Results Scenario	Idle Pressure	Peak Flow (BYPASS)		Peak Demand Pressure		Potential Causes
1	Normal	Normal	.7 to 1.0 GPM (2.5 to 4.0 LPM)	Normal	Less than 10% below idle pressure	Fuel system is operating normally
2	Normal	Low	Less than .7 GPM (2.5 LPM)	Low	Greater than 10% below idle pressure	Blocked fuel filter, inlet strainer or supply line
3	Low	Normal	.7 to 1.0 GPM (2.5 to 4.0 LPM)	Low	Greater than 10% below manufacturer's specification	Faulty pressure regulator (low pressure)
4	High	Normal	.7 to 1.0 GPM (2.5 to 4.0 LPM)	High	Above manufacturer's specification	Faulty pressure regulator (high pressure)
5	Low	Low	Less than .7 GPM (2.5 LPM)	Low	Greater than 10% below manufacturer's specification	Failing fuel pump or insufficient power supply

### Return/Filtration Methods for Mechanically Regulated Returnless Fuel Systems

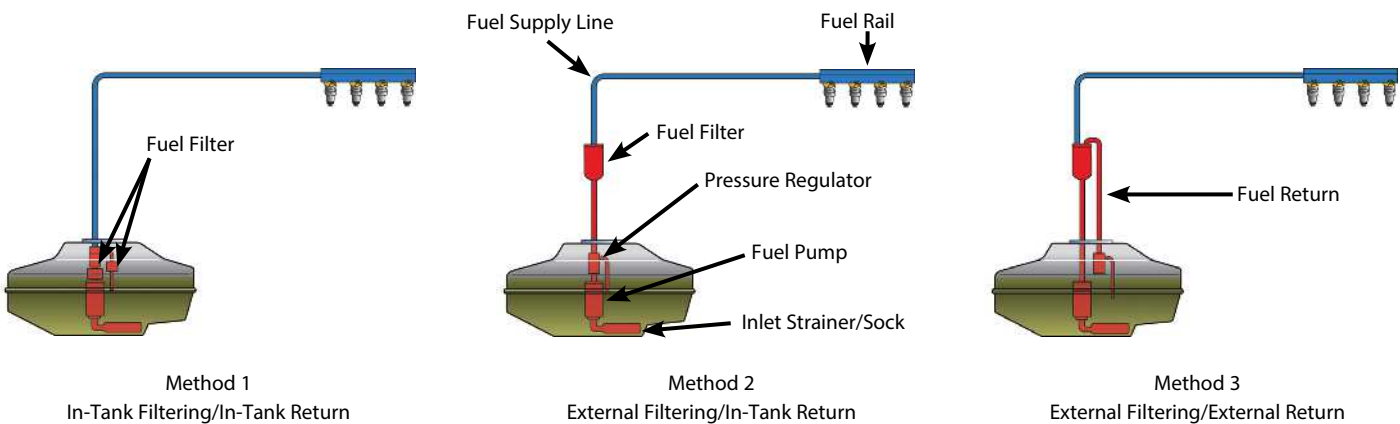

---

## Appendix C

### Returnless (Mechanically Regulated) Fuel System Diagnostic Guide

#### Scenario 2

**Diagnosis:**

A restriction to the supply of fuel to the engine such as a clogged inlet strainer, inline filter, or pinched fuel supply line will reduce the flow of fuel. This will be evident by the reduction in peak flow. Idle pressure will remain normal or drop only 1 or 2 psi below spec. Peak demand pressure will be low, depending on the amount of restriction and the type of return/filtration method used.

**Additional Action:**

Inspect the fuel supply line for damage. If the return/filtration method is type 1 or 2, connect FST between fuel tank and inline filter, and retest. If peak flow is normal, replace inline filter. If flow is still low replace inlet strainer/sock.

#### Scenario 3

**Diagnosis:**

Low idle and peak demand pressure, combined with normal peak flow is a sure indication of an under-restricting pressure regulator.

#### Scenario 4

**Diagnosis:**

High idle and peak demand pressure, combined with normal peak flow is a sure indication of an over-restricting pressure regulator.

#### Scenario 5

**Diagnosis:**

Low values for all three indicators are an indication that the output of the fuel pump is not adequate.

**Additional Action:**

Verify that the vehicle is not using a multiple speed pump. If so, a scanner must be used to operate the pump at its highest speed. Before replacing pump, follow the vehicle manufacturer's proper procedure to check for low voltage or a bad connection or ground.

## Appendix D – Returnless (Electronically Regulated) Fuel System Diagnostic Guide

Results Scenario	Idle Pressure	Peak Demand Pressure		Peak Pressure (CLOSED)		Peak Flow (BYPASS)		Potential Causes
		Normal	Less than 10% below idle pressure	Normal	50% to 100% higher than spec	Normal	.7 to 1.0 GPM (2.5 to 4.0 LPM)	
1	Normal	Normal	Less than 10% below idle pressure	Normal	50% to 100% higher than spec	Normal	.7 to 1.0 GPM (2.5 to 4.0 LPM)	Fuel system is operating normally
2	Normal	Low	Greater than 10% below idle pressure	Normal	50% to 100% higher than spec	Low	Less than .7 GPM (2.5 LPM)	Blocked fuel filter, inlet strainer or pinched supply line
3	Low	Low	Greater than 10% below idle pressure	Low	50% to 100% higher than spec	Normal	.7 to 1.0 GPM (2.5 to 4.0 LPM)	Electronic control failure, failing fuel pump or insufficient power supply
4	High	High	Less than maximum fuel volume requirement*	High	50% to 100% higher than spec	High	.7 to 1.0 GPM (2.5 to 4.0 LPM)	
5	Low	Low	Less than maximum fuel volume requirement*	Low	Less than 50% higher than spec	Low	Less than .7 GPM (2.5 LPM)	

\*See Appendix A for maximum engine fuel volume requirement

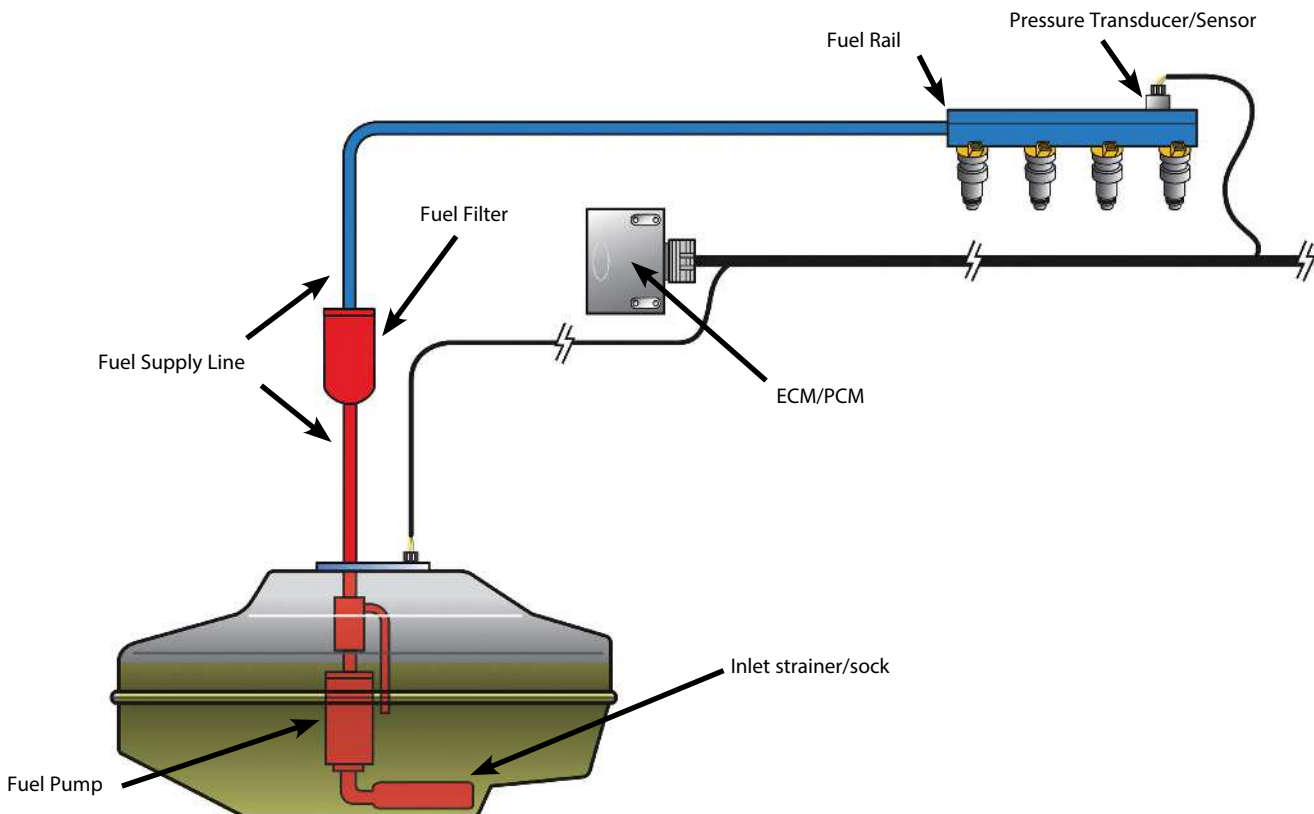



---

## Appendix D

### Returnless (Electronically Regulated) Fuel System Diagnostic Guide

#### Scenario 2

##### Diagnosis:

A restriction to the supply of fuel to the engine such as a clogged inlet strainer, inline filter, or pinched fuel supply line will reduce the flow of fuel. However, idle and peak pressure will remain normal or drop only 1 or 2 psi below manufacturer's specification. If the peak flow at idle is less than the calculated maximum fuel volume requirement, and the peak demand

pressure is low then the engine will be starved of fuel in a heavy-load condition such as wide-open throttle.

##### Additional Action:

Inspect the fuel supply line for damage. Connect FST between fuel tank and inline filter, and retest. If the peak flow and peak demand pressure are normal, replace inline filter. If still low, replace inlet strainer/sock.

#### Scenario 3, 4, 5

##### Diagnosis:

If testing with the FST indicates the engine is not receiving the proper fuel pressure and volume, and a clogged inline filter or fuel line are determined not to be the cause, then a failure of the electronic control system or the fuel pump is the most likely cause. Follow the vehicle manufacturer's recommended procedure for troubleshooting these components to determine the malfunction.