



WP-136 Universal Inline Electric Water Pump

In The Box You Will Find:

- 1 Electric Pump
- 2 5/16 – 18 x 7/8” stainless socket head bolts
- 2 5/16 AN washers
- 1 Wiring harness w/ 20 amp fuse
- 2 Contingency decals

To Do The Job You Will Need:

- 1/4 hex socket or wrench
- Plumbing (rubber or braided hose and fittings)
- Electrical wiring kit (crimps and terminals)
- The inlet fittings must be ordered separately to match your lower radiator hose.**

Applications

The Meziere Inline Electric Pump is designed to be spliced into the lower radiator hose of almost any vehicle. This eliminates the need to drive the stock water pump. It may also be used as a transfer pump, utility pump, or in a water to air inter-cooler system. Several kits are available for specific applications and many vehicles can be retrofitted with a minimum of modifications.

Mounting

Two 5/16 – 18 stainless socket head bolts are provided to mount the pump to a bracket or engine plate. Two ¼” bolts can be used through the pump for blind tapped mounting. **WARNING: DO NOT MOUNT THE PUMP INVERTED. THIS WILL VOID YOUR WARRANTY.**



Correct



Incorrect

Plumbing

The inlet and outlet of these pumps are **machined for -12AN O-ring seal, NOT ¾ NPT**. For braided hose use O-ring boss to male 37 degrees flare, (-12 to -12 and -12 to -16 available) or flare union/ flare reducer with supplied O-rings. For rubber hose use **Meziere AN to Hose Adapters** -12AN to 1-1/4, WP12125B, or 1 inch hose WP12100B, ¾ Hose WP12034B, 5/8 Hose WP12058B Braided -8, -10, -12 hose would be WP12008B, WP12010B, or WP12012B. For the inlet side only, 1 ½ WA12150 and 1 ¾ WA12175 can be used. **Caution: Never install a flared -12 end into the discharge side of this pump. The proper fitting to use is an ORB port fitting ie: wp12012b**

Wiring

The **BLUE** wire connects to **positive (+)**

The **BLACK** wire connects to chassis ground or battery **negative (-)**

TO AVOID MOTOR FAILURE be sure to use the fuse holder supplied with the harness or install your own 10 to 30 amp fuse and holder. **WARNING: NOT USING A PROTECTION CIRCUIT WILL VOID YOUR WARRANTY.**

Running

Fill the cooling system. Replace fill cap and turn on pump. Remove fill cap and top off coolant level. Recheck level after one heat cycle. **DO NOT RUN PUMP DRY for more than a few seconds.**

Beauty Tip

Your pump comes to you polished and waxed. An occasional waxing will allow dirt or debris to be wiped right off the pump and also offer some protection from UV light (the anodized color on your pump can fade from prolonged exposure to sunlight).

Thank you for purchasing our product. Feel free to contact us if we can be of further assistance and enjoy your pump for a long, long time.

WARNING: NOT USING A FUSE CIRCUIT WILL VOID YOUR WARRANTY.



WP136S PUMP FLOW VERSUS PRESSURE @ 12 VOLTS

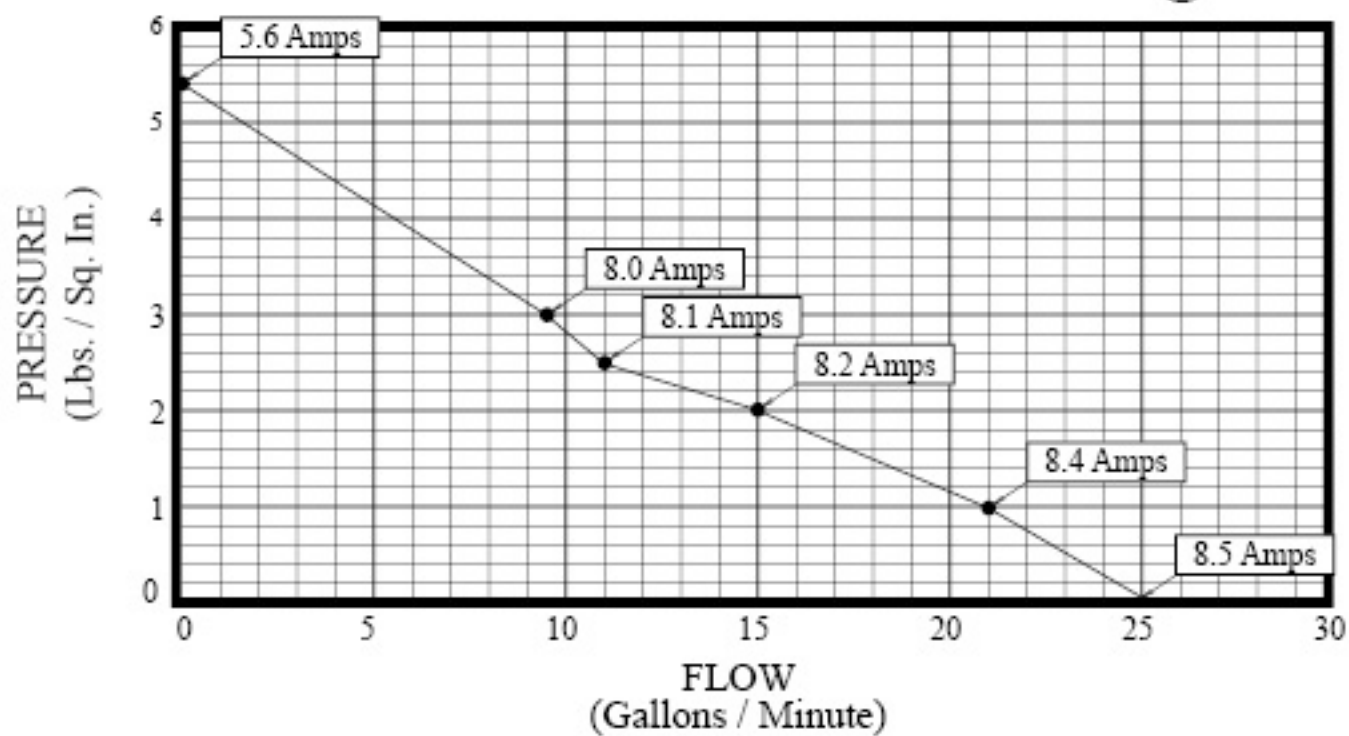

REV.		DATE	BY	APP'D

-12AN FEMALE PORT

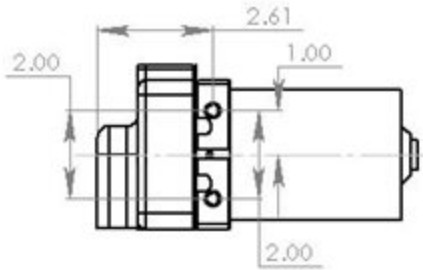
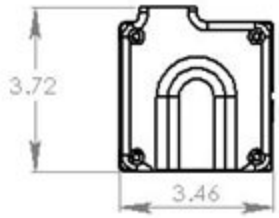
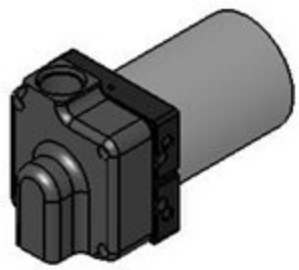
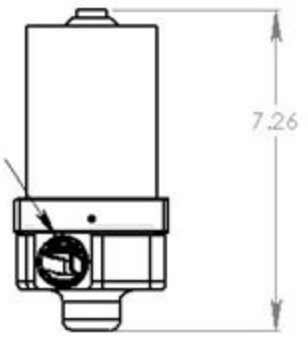

-12AN FEMALE PORT
1/8 NPT BLEED PORT

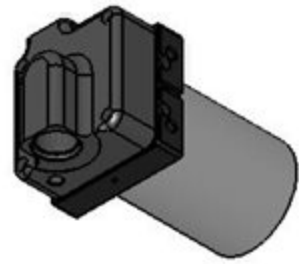
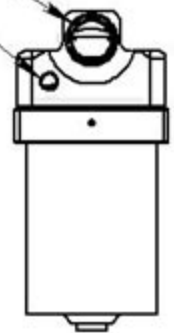

DIMENSIONS ARE IN INCHES
 TOLERANCES:
 FRACTIONS ± 1/32 DEGREE
 ANGLES ± 0.005 BEND ±
 TWO PLACE DECIMAL ± 0.01
 THREE PLACE DECIMAL ± 0.001

DATE	REV.	BY	APP'D

MATERIAL: VARIAS - ASSEMBLY
 PART NO:
 DO NOT SCALE DRAWING

Meziere Enterprises Inc.

**PUMP, 12V,
CENTRIFUGAL,
WATER/GLY, 20 GPM**

REV. A	PART NO. WP136	REV. -
--------	----------------	--------

DRAWN BY:
 CHECKED BY:
 DATE:
 SCALE:
 SHEET 1 OF 1