

Chevy Camaro 2010-2015 / Malibu 2016-up

KIT FEATURES

- Provides spacing for aftermarket speaker installation

KIT COMPONENTS

- A) (2) Base Plates • B) (16) #8 x 3/4" Phillips Screws

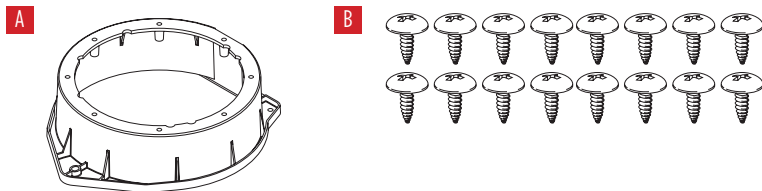

TABLE OF CONTENTS

Door Panel Disassembly.....	2
Kit Assembly	3

WIRING & ANTENNA CONNECTIONS (sold separately)

Wiring Harness: 72-5600

TOOLS REQUIRED

- Panel removal tool • Phillips screwdriver
- Socket wrench

CAUTION! All accessories, switches, climate controls panels, and especially air bag indicator lights must be connected before cycling the ignition. Also, do not remove the factory radio with the key in the on position, or while the vehicle is running.

DOOR PANEL DISASSEMBLY

1. Unclip and unplug the tweeter pod on the top of the door panel. (Figure A)
2. Remove the door handle bolt cover plate inside the door handle latch. (Figure B)
3. Remove (1) 9/32" bolt from behind cover plate. (Figure B)
4. Remove (1) T-27 Torx bolt from inside door pull cup. (Figure C)

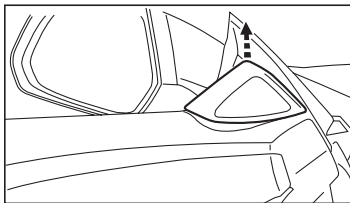

(Figure A)

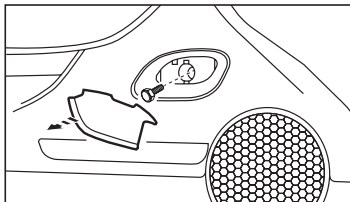

(Figure B)

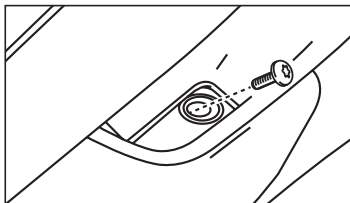

(Figure C)

5. Remove (3) 9/32" bolts from the edge of the door panel. (Figure D)
6. Unclip and remove the panel. (Figure D)
7. Unclip the door handle release cable from the panel. (Figure E)
8. Remove (1) 9/32" bolt from the top of the speaker and pull from the top to remove the speaker from the door. (Figure F)

Continue to Kit Assembly

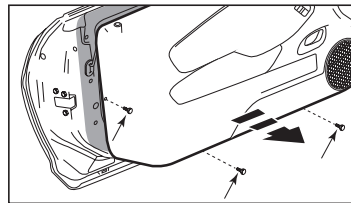

(Figure D)

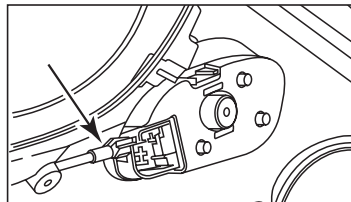

(Figure E)

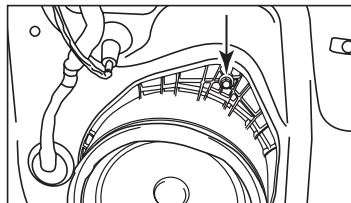

(Figure F)

KIT ASSEMBLY

1. Secure the base plate to the panel using the factory hardware.

Note: There are (2) screw holes on the bottom clip side of the base plate for added mounting reinforcement. (Figure A)

2. Secure the speaker to the ring mount either using the hardware supplied with the speaker or (4) of the supplied Phillips screws. (Figure B)

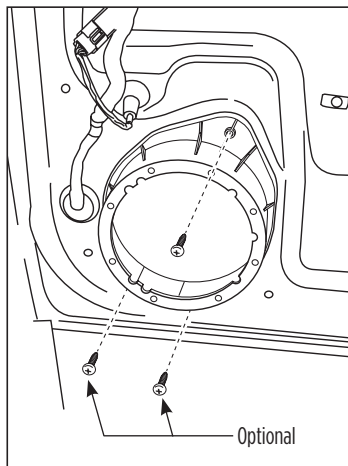

(Figure A)

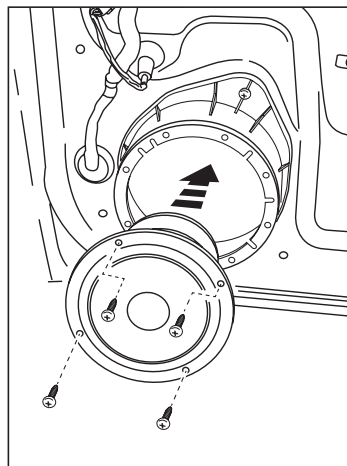

(Figure B)