

MEGAWARE



KeelGuard **PontoonGuard** **SkegGuard** **SkegPro** **ScuffBuster** **FlexStepPro** **BatteryGuard**



**EXPERTS IN PROTECTING
YOUR WATER CRAFT**



In 1992 Megaware developed KeelGuard, the industry's first patented, do-it-yourself keel protector, and has been providing boat owners with the highest quality protection ever since, including hull and gelcoat protection, pontoon tube protection, skeg protection, and others.

From the beginning, Megaware has been committed to excellence in product development, quality standards, technology and customer support. Megaware is rapidly growing and is recognized as a worldwide supplier for the smallest fishing boats to the largest coast guard fleets.

As new technologies emerge, Megaware will incorporate these advancements to further enhance its line of cutting edge, easy-to-use products. Don't trust your investment to anything less.



KeelGuard



PontoonGuard



SkegGuard



SkegPro



ScuffBuster



FlexStepPro



BatteryGuard

MEGAWARE

KeelGuard[®]

**THE ORIGINAL
DO-IT-YOURSELF
KEEL PROTECTOR**

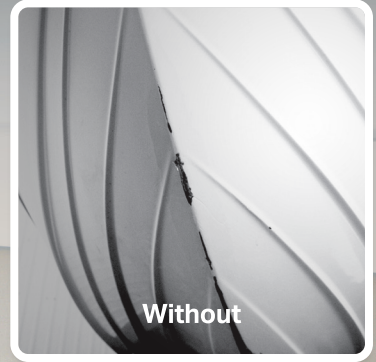
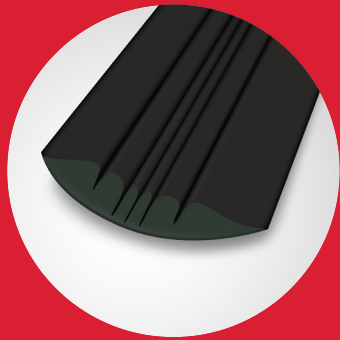

MEGAWARE KEELGUARD

801.334.5335



3M® TECHNOLOGY

All Megaware KeelGuard Products Use the Highest Quality Materials and 3M Premium Adhesives.

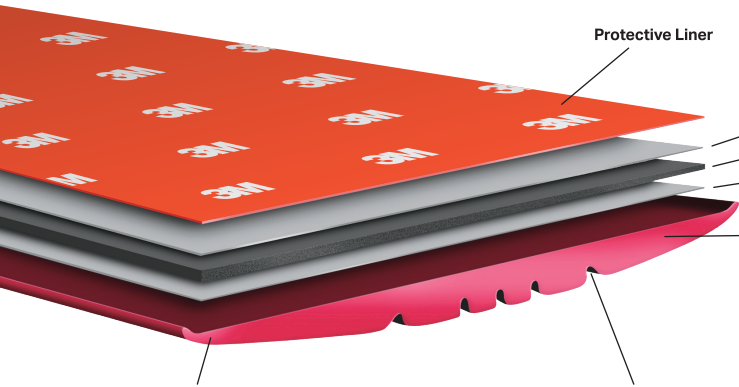

Protective Liner

Acrylic Adhesive

Acrylic Foam Core

Acrylic Adhesive

PLIABLE AND TOUGH

Ultra-Tough Polymer Composite

- Pliable, Conforms to Keel
- High-Quality Polymers and Urethanes
- Shock Absorbent

CONTOURED EDGE

- Creates a Clean, Tight Seal
- No Messy Sealants Needed

RESEARCH AND TECHNOLOGY

Hydrodynamic Drag Reduction Channels

- Patented Drag Reduction Design
- Angled Grooves Create Air Pockets and Provide a Slicker Surface
- Will Not Slow Your Boat Down

THE RIGHT BALANCE

3M Acrylic Pressure-Sensitive Adhesive

- 3M Adhesive Self-Seals to Hull Surface
- Right Balance of Strength and Bonding



- **Protect Against Abrasive Sand, Rocks, Concrete Ramps, and Oyster Beds**
- **Eliminate Costly Repairs**
- **Enjoy the Highest Quality and Superior Engineering**
- **Increase the Value of Your Boat**

Wear and damage to your boat's keel can break down its protective gelcoat finish, allowing water to reach and destroy the fiberglass laminates. Megaware KeelGuard, the powerful abrasion-resistant protector, prolongs the life of your boat like nothing else.

Megaware KeelGuard Patented Engineering

Every aspect of the patented Megaware KeelGuard has been developed with boat designers and 3M engineers. Many factors contribute to its success. A precise, abrasive-resistant blend of polymers and urethanes achieve optimal durability and pliability. A pressure-sensitive 3M adhesive creates strength, while permanently bonding and sealing the Megaware KeelGuard contoured edges to the hull surface. Angled grooves produce hydrodynamic channels, creating air pockets and providing a slicker surface. The perfect combination of these factors makes the Megaware KeelGuard the easiest keel protector to install, providing unparalleled quality and dependability.

KeelGuard.com

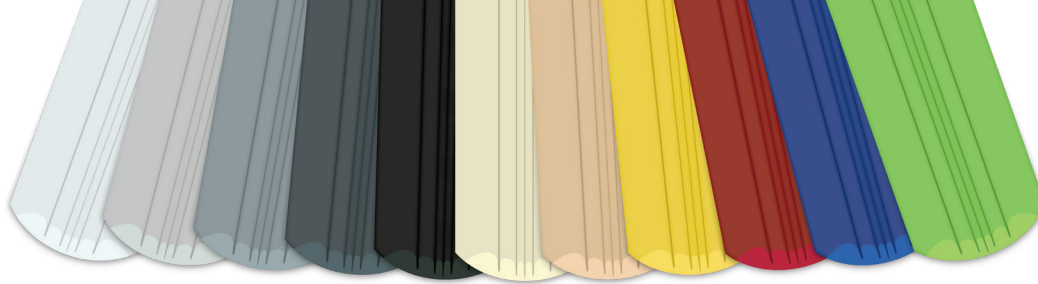

White Light Gray Gray Charcoal Black Almond Sand Yellow Red Blue Lime Green

Enhance Your Watercraft

Megaware KeelGuard's sleek lines and contoured shape enhance the performance and look of your watercraft. Its engineering and aesthetics remain second to none.

KeelGuard Lengths and Colors

Megaware KeelGuard comes in 11 great looking colors to match virtually any boat. All colors are UV-stabilized for true color that lasts a lifetime. Megaware KeelGuard is available in nine standard lengths or can be ordered in custom lengths.



Size Chart

KeelGuard	Boat Size
4 ft	Up to 14 ft
5 ft	Up to 16 ft
6 ft	Up to 18 ft
7 ft	Up to 20 ft
8 ft	Up to 22 ft
9 ft	Up to 24 ft
10 ft	Up to 26 ft
11 ft	Up to 28 ft
12 ft	Up to 30 ft

Product Width: 5"



Trusted Protection

As seen on Ship Shape TV and featured on Aaron Martin's Bass Edge Podcast, Megaware KeelGuard is the first choice for boat hull protection by many professional fishermen.

Megaware KeelGuard has been protecting watercraft of all kinds, including recreational boats, fishing boats, dinghies, rigid inflatables, and coast guard fleets.

Do-It-Yourself Easy Application in 4 Basic Steps

Installs Easily in an Hour or Less



- 1 **ETCH** with Scotch-Brite Pad
- 2 **CLEAN** with Alcohol (Not Included)
- 3 **PRIME** with 3M Primer
- 4 **APPLY** with Burnishing Tool

Note: If your trailer is designed with the boat resting on center rollers or a support beam along the keel, we do not recommend installing a keel protector. If the rollers can be lowered or the side bunks raised to clear the roller, the Megaware KeelGuard adhesive bond will not be compromised. The Megaware KeelGuard is not suitable for some aluminum boats, pontoons, catamarans, personal watercraft, or boats with a non-standard V shaped keel. Please call for suitability.

Included Do-It-Yourself Application Kit



- Patented Burnishing Tool
Insures Professional Results
- No Extra Tools Needed

"I would just like to compliment you on your clear instructions and a wonderful product. I installed it in about 45 minutes, and it truly looks as if it were part of the original manufactured vessel."

Martin C. Megaware KeelGuard Customer

Machine-Tapered Ends
Aid in the Reduction of
Drag or Snags

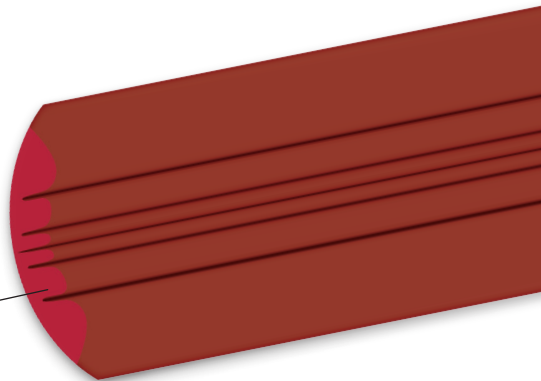

MEGAWARE
KeelGuard[®]

LIFETIME WARRANTY

Megaware KeelGuard is so tough and reliable that we include a lifetime warranty. Megaware KeelGuard is guaranteed to protect your boat for life. In the unlikely case in which problems arise, we replace it for free. It really is that simple.

MEGAWARE

PontoonGuard[®]

**PROTECT EXPOSED &
VULNERABLE AREAS OF
YOUR PONTOON**

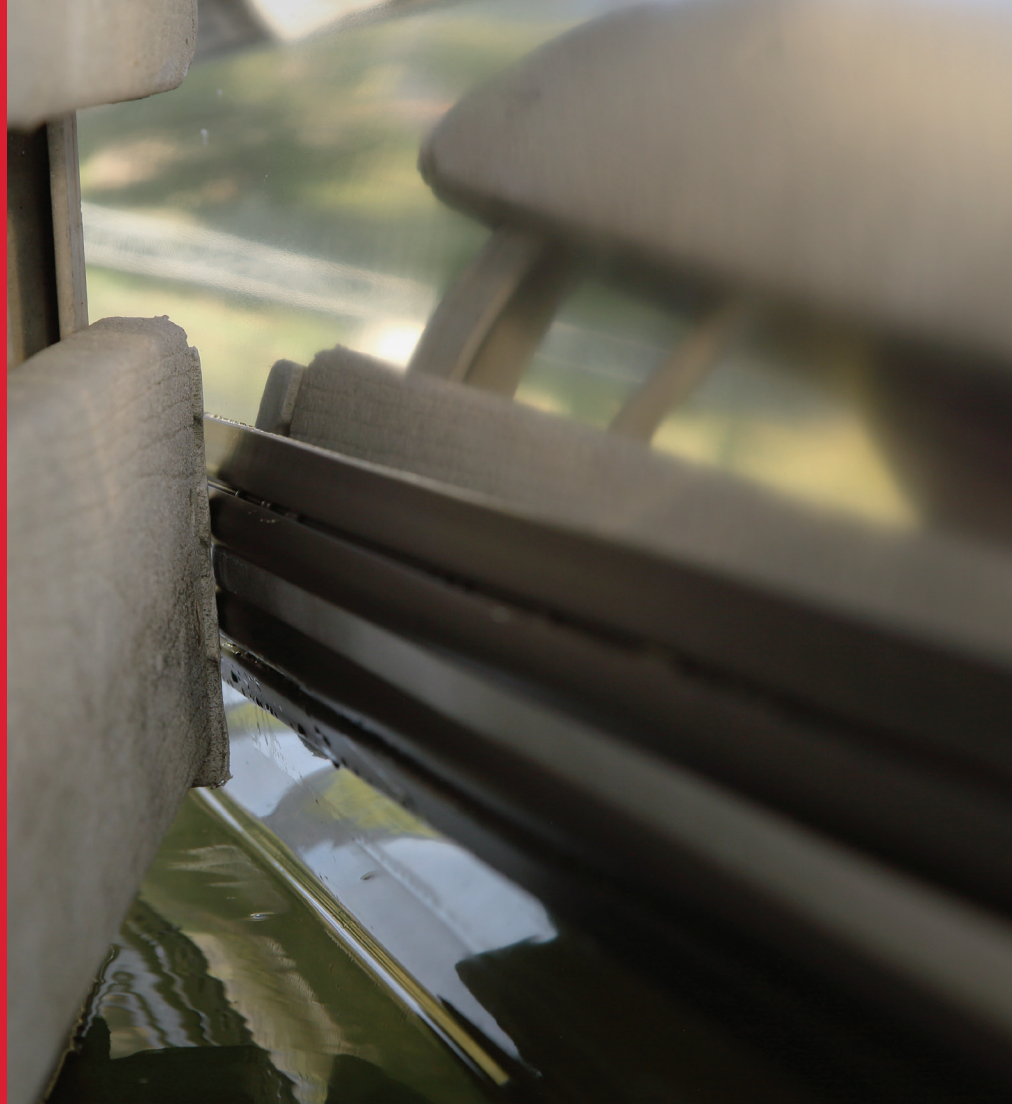
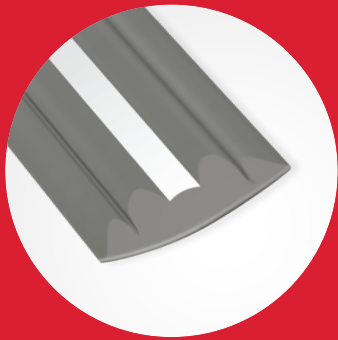



Protect & Customize Your Pontoon While Increasing Safety

Megaware PontoonGuard is a custom engineered protection and safety product designed specifically for the pontoon boat market.

Megaware PontoonGuard provides protection to the side of the tubes against abrasion and chafing caused by docks, other pontoons, and hidden obstacles.



MEGAWARE
PontoonGuard[®]

- **Protect Vulnerable and Exposed Areas of Your Pontoon**
- **Make Your Vessel More Visible During Night Operations or While Anchored or Beached**
- **Avoid Unsightly Dents, Scratches, and Scrapes from Docking Your Pontoon**
- **Add a Custom Sleek Look to Your Pontoon**
- **3 Year Warranty**

SUPER STRONG ¼ INCH THICK ULTRA-TOUGH POLYMER COMPOSITE

For Maximum Durability

3M
ADHESIVE SYSTEM

3M[®] REFLECTIVE STRIP

Increases Visibility and Safety

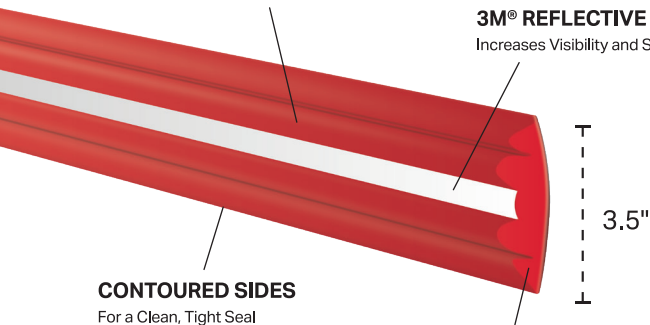

CONTOURED SIDES

For a Clean, Tight Seal

MACHINED CONTOURED LEADING EDGE

For a Sleek, Streamlined Look

Sizes

For Pontoons up to 21 ft.

32 ft Kit - (2) 16 ft. Length
Megaware PontoonGuards

For Pontoons 22-25 ft.

40 ft Kit - (2) 20 ft. Length
Megaware PontoonGuards

Colors



Black

Gray

Red

Blue

Megaware PontoonGuard incorporates a 3M reflective strip to enhance the visibility of the pontoon in nighttime or low-light conditions when illuminated by a light source such as headlights or search lights. This can be useful either on or off water while beached, anchored, trailered or parked.

MEGAWARE

Skeg Guard[®]

**THE INEXPENSIVE
SOLUTION TO A BROKEN
OR DAMAGED SKEG**

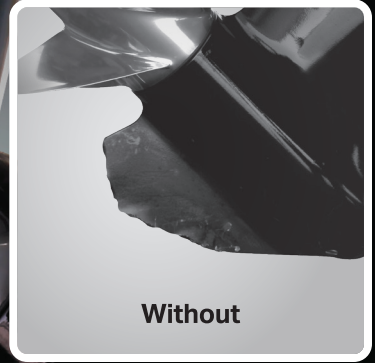

Without

Megaware SkegGuard Engineering

Megaware SkegGuard's 3mm thickened lower plate will withstand damage or abrasion from hidden rocks and debris or accidental ramp dragging. It conforms to your lower unit to insure there is no discernable drag or compromise in performance. Each kit comes with self locking mounting hardware and hex wrenches.

Model Guide

For motors not listed use our model finder tool at keelguard.com

EVINRUDE/JOHNSON

**Does not fit Lightning Gearcase*

- 27131** • 40-50-55-60 2 Stroke E-TEC 2004-Present
• 65 1996-2012
- 27121** • 65 2 Stroke E-TEC 2013-2015
• 75-90-115-130 2 Stroke E-TEC 20" Shaft 2006-Present
- 27101** • JOHNSON 100-115-120-140 1980-2001
- 27081** • 90-115-130 E-TEC 25" or 30" Shaft 2006-Present
- 150-175-200-20" Shaft E-TEC 2006-Present
- 27091** • 135-175-200 25" or 30" Shaft E-TEC 2 Stroke 2006-2014
• 150 25"-30" Shaft E-TEC 2006-Present
• 225-250-300 E-TEC 2002-2014
- 27281** • 150-175-200-225-250-300 E-TEC G2 (Curved) 2015-Present

HONDA

- 27171** • 35-40-45-50 4 Stroke 1991-Present
• 90 4 Stroke & V-TEC 2008-Present
- 27071** • 60-75 4 Stroke 2010-Present
• 75-90 15 4 Stroke 1995-2007
- 27271** • 115 4 Stroke 2010-Present
• 135-150-200-225 4 Stroke 2004-Present

MARINER

- 27341** • 40-50-60 2 & 4 Stroke 2003-2011
- 27071** • 50-60 Bigfoot 2003-2011
• 70-90-100-115-125 2/4 Stroke 1983-2011
- 27211** • 150-175-200-225-250-275-300 Verado 2005-2011
- 27061** • 135-150-175-200 2/4 Stroke & Optimax 1978-2005
• 135-150-175-200 Optimax 2 Stroke 2005-2011

MERCURY

- 27021** • MERCURUISER Alpha I 1985-1990
- 27031** • MERCURUISER Alpha I Generation II 1991-Present
- 27051** • MERCURUISER Bravo I & III 1990-Present
- 27011** • MERCURUISER Pre-Alpha I Drives 1973-1984
- 27071** • 40-50-60 Bigfoot 2001-2013

- 40-50-60 Command Thrust 2014-Present
- 50 4 Stroke 2006-2014
- 75-90-115 2/4 Stroke & Optimax 2003-2014
- 125 2 Stroke 2000-2005
- 27341** • 40-60-254 Stroke 2003-Present
- 50 2 Stroke 2006-2014
- 50 4 Stroke 2016-Present
- 55 2003-2011
- 27211** • 90-115 Command Thrust & ProXS CT 4 Stroke 2014-Present
- 75-90-115-150 SeaPro 2018-Present
- 150 4 Stroke & Verado 2012-Present
- 175-200-225 Verado 4.8" Gearcase 2005-2018
- 200-250-300 4 Stroke PRO Verado 4.8" Gearcase 2015-2018
- 200-225-250 2 Stroke Optimax & ProXS 1999-2018 (Not compatible with Torque Master)
- 27061** • 75-90-115 4 Stroke 2015-Present
- 135-150-175-200 2 Stroke & XR6 2000-2005
- 150-175 2 Stroke Optimax & ProXS 2001-2018
- 27311** • 225-250-300 Verado 5.44" Gearcase 2014-2019
- 350 & 400 L6 Verado 5.44" 2015-Present
- 27411** • 175-200-225 3.4L V6 4 Stroke, 4.8" Gearcase 2019-Present
- 175-200 PROXS 3.4L V6 20" Shaft 4.8" Gearcase 2019-Present (No Torquemaster)
- 27412** • 200-225-250-300 V8 PROXS Torque Master 4.6L V8 20" Shaft, 4.8" Gearcase 2019-Present (Not compatible with 25" Shaft, 5.44" Gearcase Model)
- NISSAN/TOHATSU**
- 27171** • 40-50 2/4 Stroke 1993-Present
- 60 4 Stroke BF(TW) 2014-Present
- 27071** • 70-75-90-111-120-140-150 2/4 Stroke 1993-Present

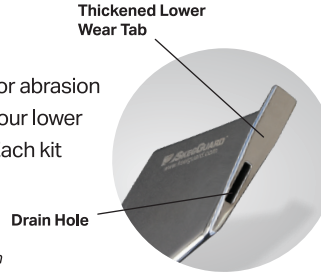

- **Mirror Polished 18 Gauge Marine Grade 316 Stainless Steel**
- **Thickened Lower Wear Tab Protects Against Ramp Dragging and is Great for River Running**
- **Drain Hole Prevents Corrosion and Freezing**
- **Won't Compromise Performance**
- **Do-It-Yourself Install in Less Than 10 Minutes**
- **Installs with as Little as 2-3 Inches of Skeg Remaining**
- **Avoid Expensive Repair Costs**
- **3 Year Warranty**

Megaware SkegGuard both protects and prevents damage to your motor's skeg and can also be used to repair and replace an already broken skeg.

MEGAWARE

SkegPro[®]

**STOP DAMAGE TO YOUR
BOAT'S SKEG BEFORE IT'S
TOO LATE**

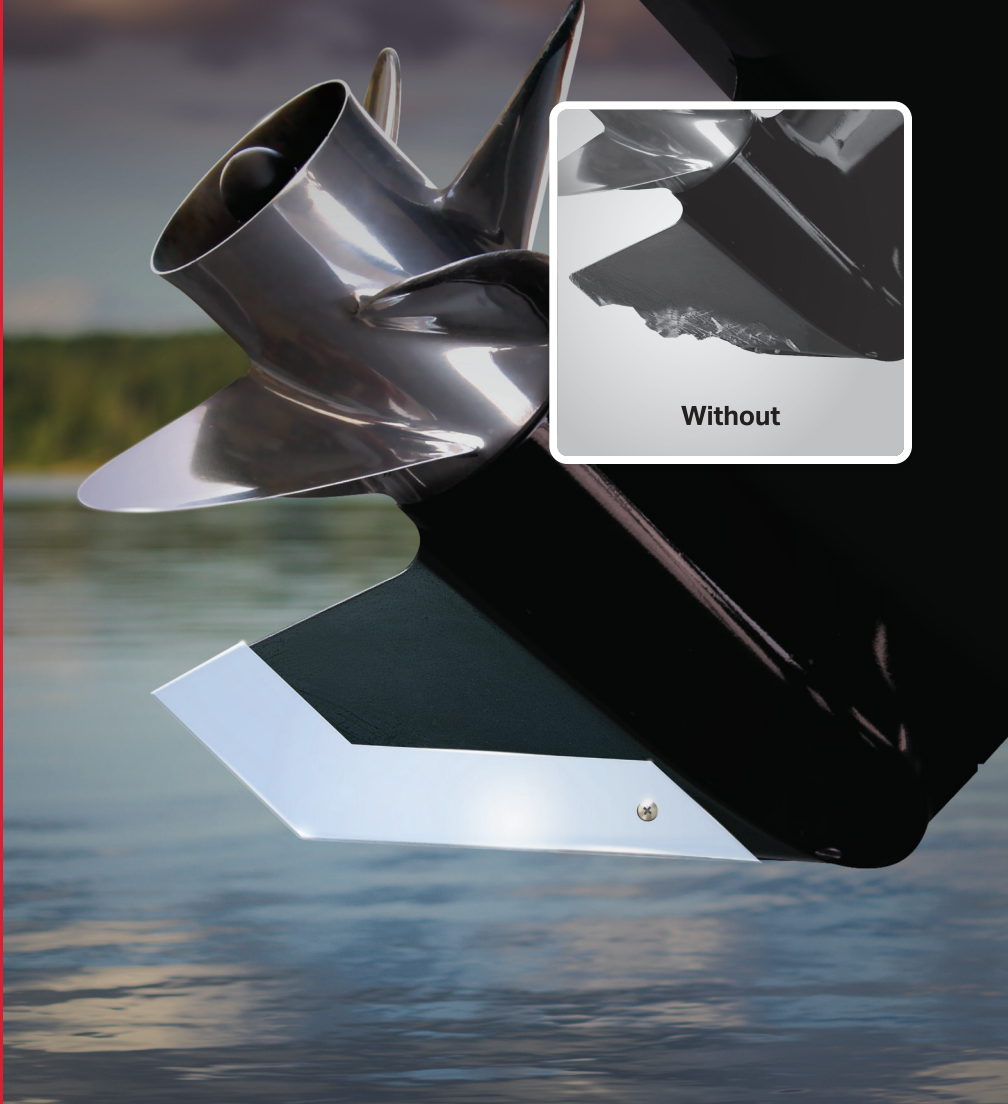

Without

Megaware SkegPro Skeg Protector

Megaware SkegPro protects your motor's skeg against harsh marine environments. Its mirror-polished stainless steel creates a custom look and provides lasting protection.

Model Guide

For motors not listed use our model finder tool at keelguard.com

EVINRUDE/JOHNSON **Does not fit Lightning Gearcase*

- 658** • 40-50-55-60 2 Stroke E-TEC 2004-Present
 - 65 2 Stroke 1996-2015
 - 75 2 Stroke 20" Shaft 2007-2015
 - 90-115-130 20" Shaft 2006-Present
- 664** • 90-115-130 25"-30" Shaft 2006-Present
 - 150-175-200 20" Shaft E-TEC 2006-Present
- 673** • 135-175-200 25"-30" Shaft E-TEC 2006-2014 (No G2)
 - 150 25"-30" Shaft E-TEC 2006-Present
 - 225-250-300 E-TEC 2002-2015 (No G2)
- 674** • 150-175-200-225-250-300 E-TEC G2 (Curved) 2015-Present

HONDA

- 658** • 115 4 Stroke 2010-Present
 - 135-150-200-225 4 Stroke 2004-Present

MARINER

- 665** • 40-50-60 2 & 4 Stroke 2003-2011
- 655** • 50-60 Bigfoot 2003-2011
 - 70-90-100-115-125 Optimax 2 & 4 Stroke
 - 1983-2011
 - 135-150-175-200 Optimax 2 Stroke 1978-2011
 - 135-150-175-200 4 Stroke 1978-2005
- 656** • 150-175-200-225-250-275-300 Verado 2005-2011

MERCURY

- 655** • Mercuriser Pre-Alpha I Drives, Alpha I,
 - Alpha I Generation II
- 667** • Mercuriser Bravo I & III 1990-Present
- 668** • Mercuriser Bravo II 1994-2018
- 655** • 40-50-60 Bigfoot 2001-2013
 - 40-50-60 Command Thrust 2014- Present
 - 50 4 Stroke 2006-2014
 - 75-90-115-125 2/4 Stroke & Optimax 2003-2014
 - 135-150-175-200 2 Stroke & XR6 2000-2005
 - 150-175 Optimax & ProXS 2 Stroke 2001-2018
- 665** • 40-60 2&4 Stroke 2003-2018
 - 50 2 Stroke 2006-2014
 - 50 4 Stroke 2016-Present
 - 55 2003-2011

- 656** • 90-115 4 Stroke Command Thrust & ProXS CT 2014-Present
 - 150 4 Stroke and Verado 2012-Present
 - 175-200-225 Verado 4.8" Gearcase 2005-2018
 - 200-225-250 Optimax & ProXS 2 Stroke 1999-2018 (Not compatible with Torque Master)
 - 200-250-300 PRO Verado 4 Stroke 4.8" Gearcase 2015-2018

SUZUKI

- 655** • 150/150A-175/175A-200/200A-225 2&4 Stroke 1986-Present
 - 250 4 Stroke 2004-Present
- 664** • 250SS-300 4 Stroke 2008-Present (Not compatible with AP Models)
- 658** • 50AV-60AV 4 Stroke 2014-Present
 - 90 4 Stroke 2001-2010
 - 100/100A-115/115A-140/140A 4 Stroke 2001-Present

YAMAHA

- 664** • 50-60 High Thrust 4 Stroke 1996-Present
 - 60-70-90 2 Stroke 2001-2009
 - 70 4 Stroke 2010-Present
 - 75-80-90-100 4 Stroke 2003-2016
- 665** • 30 & 60 4 Stroke 2002-Present
 - 40-50 2 & 4 Stroke 2001-Present
- 663** • 75-90 4 Stroke 2017-Present
 - 115-130 2 & 4 Stroke 2001-Present
 - 150-175 2 & 4 Stroke 1984-Present
 - 200 2 Stroke HPDI 2000-2012
 - 200 4 Stroke 2.8L I-4 2012-Present
 - 300 4 Stroke 2007-2009
 - 350 4 Stroke 2007-Present
 - I/O Sterndrive Models 1989-1993
- 655** • 200 4 Stroke V6 2002-Present
 - 225 2/4 Stroke 1997-Present
 - 250 2/4 Stroke 1990-Present
 - 300 2 Stroke 2004-2006
 - 300 4 Stroke 2010-Present
- 674** • VMAX HPDI & SHO
 - 200-225-250 4 Stroke VMAX SHO 2013-Present
 - 200-225-250-300 2 Stroke VMAX HPDI 2004-2010



- **Protect Against Ramp Dragging, Rocks, Debris, and Submerged Objects**
- **Drain Hole Prevents Corrosion and Freezing**
- **Installs Easily in Less Than 10 Minutes**
- **A Model to Fit Virtually any Skeg**
- **Avoid Expensive Repair Costs**
- **3 Year Warranty**

Megaware SkegPro conforms to your lower unit to insure there is no discernable drag or compromise in performance. A drain hole keeps water from collecting and remaining stagnant.

MEGAWARE

Scuff Buster™

**PROTECT YOUR BOAT
FROM UNSIGHTLY ROLLER
AND TRAILER SCUFFS**



Megaware ScuffBuster Products

Protect your boat from unsightly marring. Made from anti-corrosive, 22-gauge 304 stainless steel, Megaware ScuffBuster products attach to your boat's surface with the highest quality materials and 3M® pressure-sensitive adhesives.

Bow Guard

XL and Standard Sizes

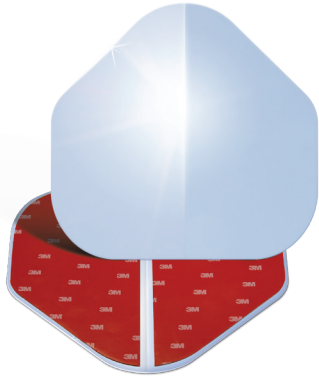

XL

9" X 8.75"

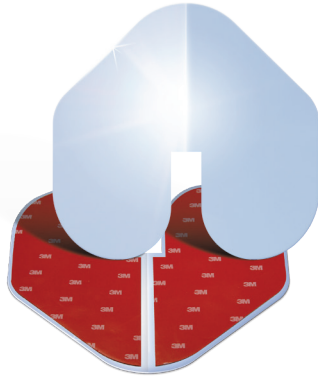

XL With Notch

9" X 8.75"



- **Protect Your Boat's Gelcoat**
- **Minimize Roller and Trailer Scuffs**
- **Bend to Conform to Hull**
- **Mirror Polished Finish**



Standard

5.75" X 4.5"



Standard With Notch

5.75" X 4.5"

MEGAWARE

FlexStep[®]Pro

**MAKE BOATING EASIER
WITH THE ADJUSTABLE
TRAILER STEP**



Adjustable Boat Trailer Step

Megaware FlexStep Pro makes boating more convenient than ever. This innovative multi-angle/extendable step system attaches to your trailer frame, allowing easy access to virtually anywhere on your boat. A quick, spring loaded pull handle and locking pin system adjusts the FlexStep Pro to 16 positions for maximum reach.

Using just four bolts, the Megaware FlexStep Pro mounts to your trailer frame (accommodates trailer rails up to 5 1/8" tall, and trailer tongues up to 4" wide*) in just minutes and easily disconnects with a single pin for safe storage during travel.

*Mounting to the trailer tongue may require longer bolts which can be purchased at most hardware stores.

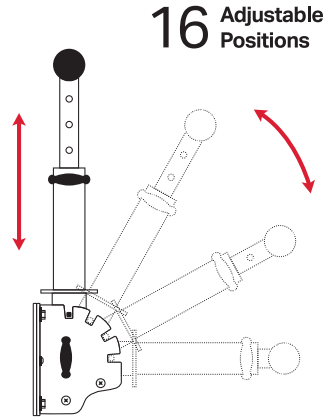

MEGAWARE
FlexStep[®]Pro

- 16 Adjustable Positions
- Extends from 17 to 21 Inches
- Removable for Safe Travel and Stowing
- Fits Most Trailer Rails
- 3 Year Warranty



**Easy Boat Entry
and Exit**



**Easy Access to
Windows and Storage**



**Easy Installation
and Stowing**

Megaware FlexStep Pro is manufactured from lightweight, high tensile 6063-T6 anodized aluminum ensuring the highest quality. Each step safely holds up to 300 lbs.

MEGAWARE

BatteryGuard™

**SAVE MONEY BY
PROLONGING THE LIFE OF
YOUR BATTERY**

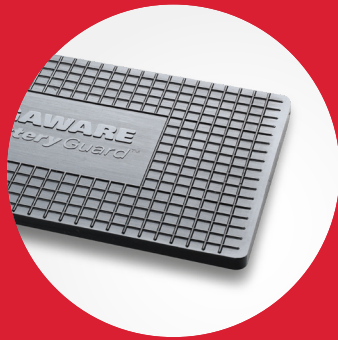

**Megaware BatteryGuard™
Acts Like a Shock Absorber
for Your Battery and Can
Easily be Trimmed to
Custom Shapes or Sizes**



Maximize Your Battery's Performance

Megaware BatteryGuard™ sits under your battery and absorbs the gravity shock caused by excessive vibration and up and down bounce.



MEGAWARE
BatteryGuard™

Battery G Shock Performance Comparison

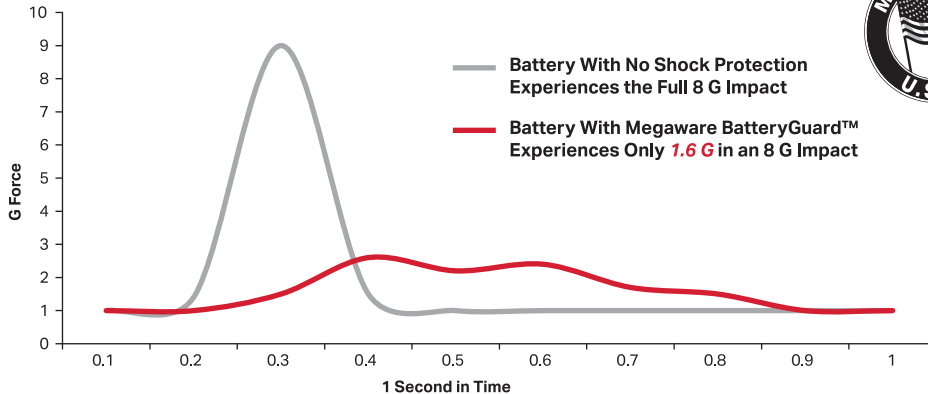

- Reduces up to 80% of the G-shock Caused by Excessive Shock and Vibration
- Great for Boats, Automobiles, ATVs, Trailers, or Anywhere Shock and Vibration Can Damage a Battery
- Dimensions: 12¾" × 6⅞" × ⅜"
- Fits up to Group 31 Batteries

Scientific Explanation: When a battery is subjected to extreme vibration and shock, cracks occur at the interface of mechanical joints inside the battery and its cells. While some batteries are designed to withstand these forces better than others, all batteries can be damaged by shock and vibration over time. Battery failure will often be preceded by performance fading. This is because the stress of shock and vibration causes micro fractures inside the battery which reduce internal conductivity and cause a battery to have low voltage. Over time, as the micro fractures continue to propagate in the battery's conductive components, internal resistances increase. This condition reduces the flow of amps which are required to power electrical components. Another cause of performance fading is the physical collision of battery plates as a result of shock and vibration. This condition causes a short in a cell or cells. This also, may cause a battery to have low voltage and insufficient power.

NOTE: Clamping the battery too tightly in place and compressing the pad may decrease the pads effectiveness.

CAUTION: This product may excrete oil and stain certain surfaces and is recommended for placement in battery trays or boxes only.

Megaware BatteryGuard™ acts like a shock absorber and can help extend the life of your expensive battery. Excessive shock and vibration are two of the leading causes for battery failure. Megaware BatteryGuard™ sits under your battery and absorbs the gravity shock caused by excessive vibration and up and down bounce.

