

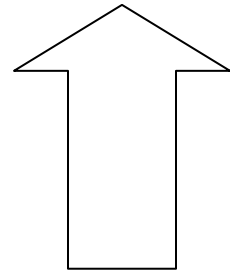

Template Instructions

Master Power Brakes are proud to offer a high quality product at the industries most competitive pricing!

***ATTENTION: Read this before going any farther!
Returns will not be accepted for ANY installed PART or
ASSEMBLY. Use great care to prevent cosmetic damage
when performing wheel fit check.***

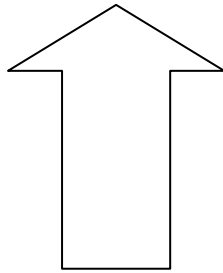
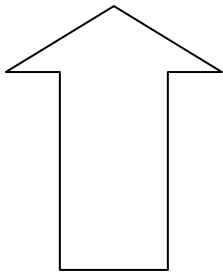

IMPORTANT! After printing a template, check that the inch scale at the bottom right corner of the page matches up to a ruler or tape measure.

After you have printed a template, **PLEASE** re-check that the scale at the bottom right corner matches up to a ruler or a tape measure. Once you have verified that the template has been printed to the proper size, glue the entire page to a piece of heavy card stock and cut around the **BOLD** dotted line. Leave the hub section of the template whole until you have accurately measured the inside of the wheel hub. See photo 1:

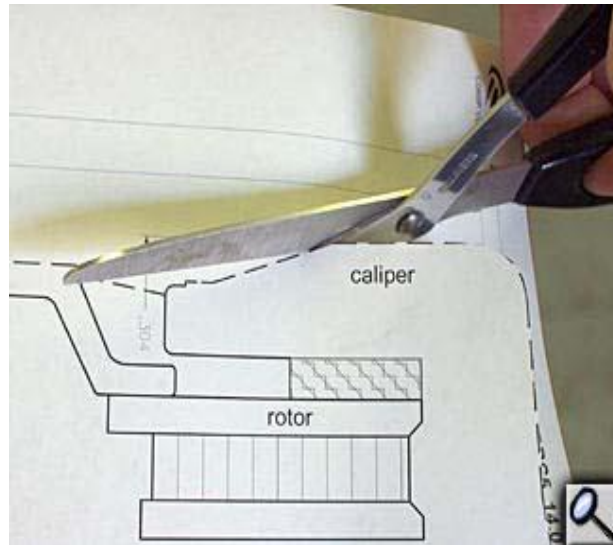

Photo 1

After you have cut the template along the bold dotted line, measure the inside diameter of the wheel where the hub goes inside the wheel. The wheel in this photo has a chamfer at the top of the hub hole. **DO NOT MEASURE THE OUTSIDE DIAMETER OF THE CHAMFER!** Measure the inside diameter of the hub hole only! This wheel measured $2\frac{3}{4}$ " (from the 4" mark to the $6\frac{3}{4}$ " mark) $2\frac{3}{4}$ " = 2.750" After you have determined the ID of the hub hole, trim the final size of the hub area on the template using the measurement lines printed on the template. See photo 2:



Photo 2



It is **IMPORTANT** that to follow the measurement lines accurately on each side of the hub area on the template! See photo 3 below:

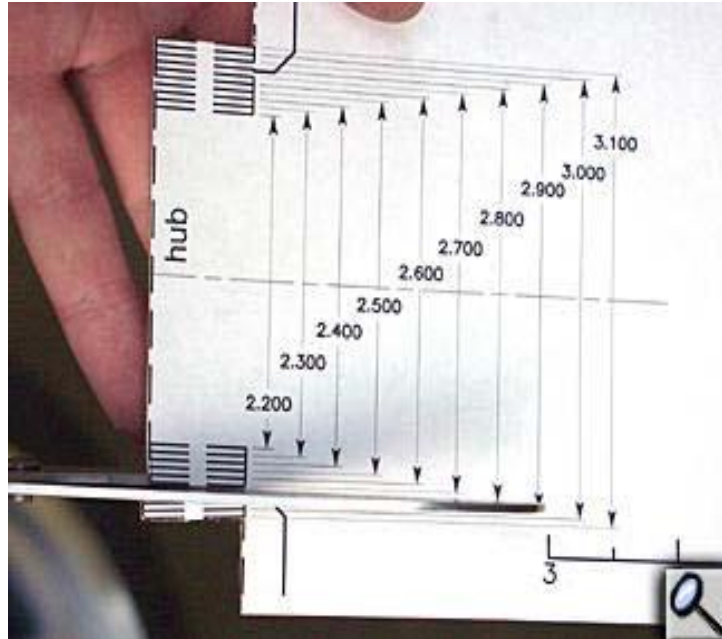

Photo 3

Once you have trimmed the hub area of the template, place the template into the back of the wheel. The hub area of the template should fit down into the hub hole in the wheel. This "Extreme" system template fits into this wheel with one exception; the template is resting on the spoke of the wheel and not allowing the template to rest flat on the hub section of the wheel. Also note that the template is very close to hitting at the top of the wheel to the top of the caliper. See photo 4:

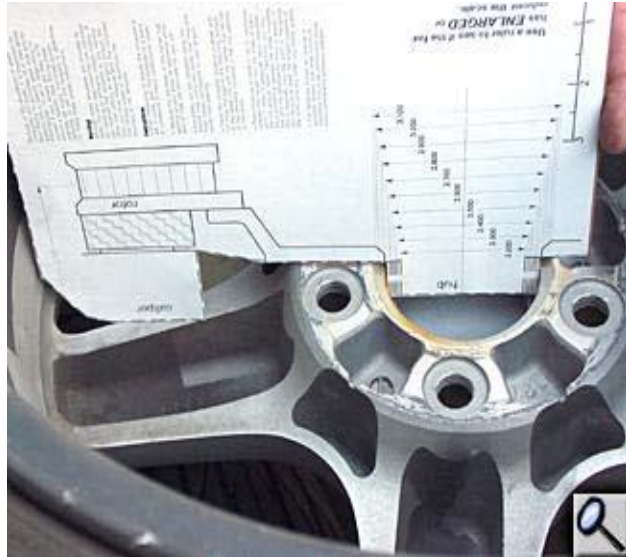

Photo 4

In this case the template is being "Spaced" out by using washers between the template and the wheel hub. The washers simulate a wheel spacer that can be used gain extra clearance from the outer side of the caliper to the wheel spokes. As the wheel is "Spaced" away from the car's hub, the rim of the wheel falls away from the top of the caliper allowing a little extra clearance. Recommended clearance is at least 0.100" to any point in the wheel. This "Extreme" system template would work with this wheel if a ¼" wheel spacer is used between the hub and the wheel. See photo 5 below:

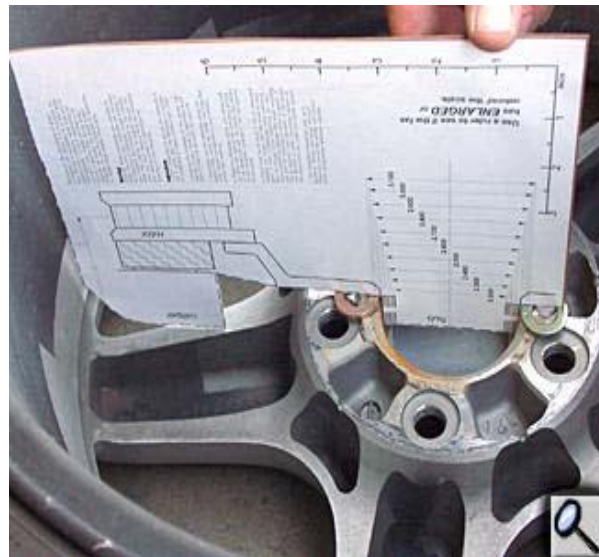
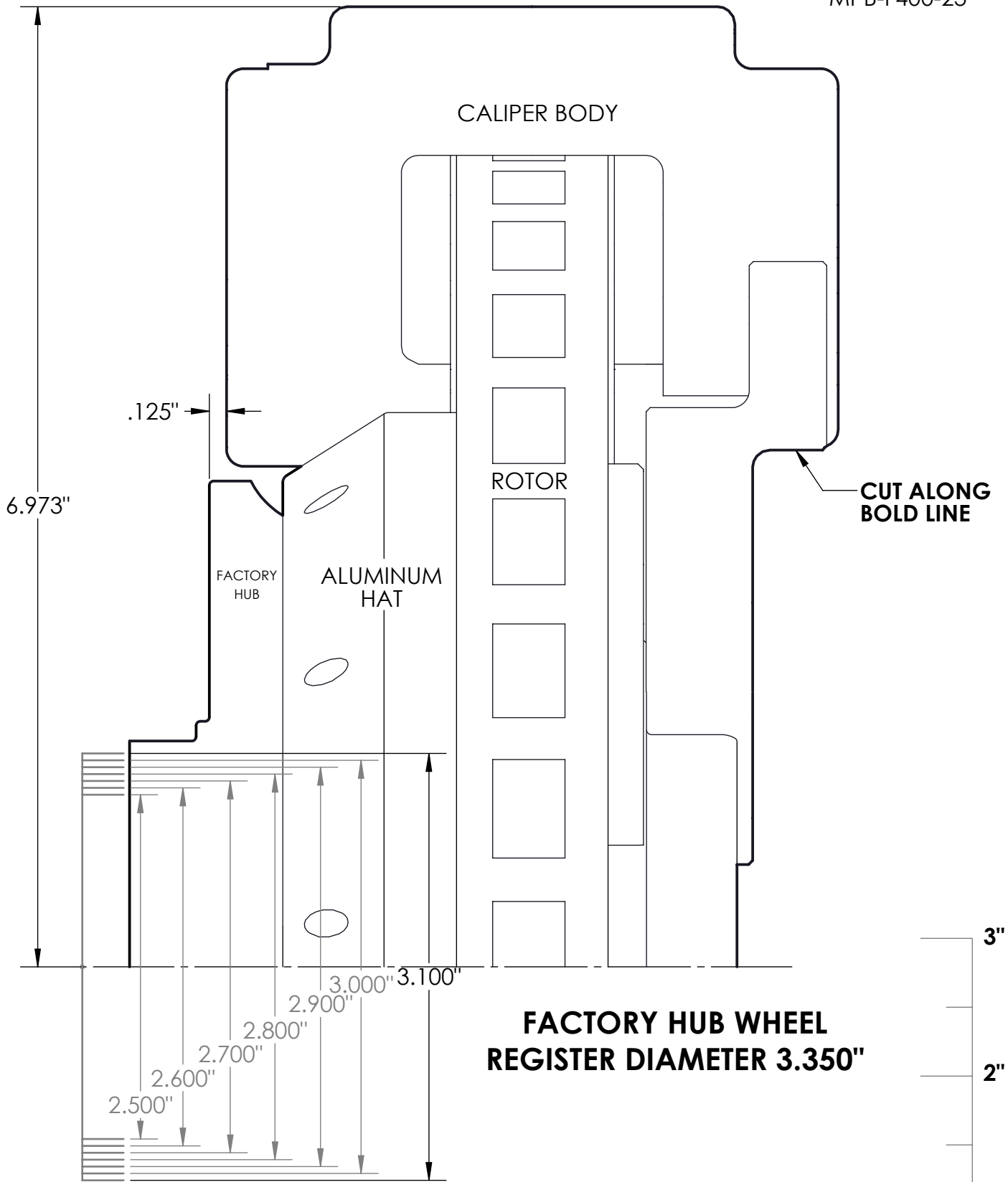

Photo 5

****IF SPACERS WILL BE USED, BE SURE TO CHECK FOR PROPER WHEEL STUD LENGTH!**



FACTORY HUB WHEEL REGISTER DIAMETER 3.350"

Measure hub center of the wheel, select corresponding size and cut out accordingly



Use provided ruler to verify template has printed to scale

