

**Master
Lock®**



COMMERCIAL SECURITY PRODUCT CATALOG

CUSTOM BUILT | COMMERCIAL QUALITY | COMPLETE SECURITY

MASTER LOCK® COMMERCIAL SECURITY

ABOUT US

Recognized as the authentic, enduring name in padlocks and security products, Master Lock® has set the standard for quality and selection for more than 95 years.

THE BROADEST LINE

Master Lock offers a full line of products for virtually any commercial, institutional and industrial security and safety application.

SUPERIOR PRODUCT QUALITY

All Master Lock products are built with the unmatched strength and durability that you've come to know and trust. Each lock is individually tested to ensure years of trouble-free operation, dependable performance and peace of mind.

CONTROLLED KEY SECURITY

Establish a safe, secure and convenient locking system – Master Lock stands alone among padlock suppliers in designing security into the padlock's cylinder and operating key, and providing key and installation database security management services as needed to assure the utmost in system integrity.

UNMATCHED SALES SUPPORT

Service is available to you through our broad network of distributors as well as Master Lock's experienced sales organization.

PERSONAL SERVICE

Our inside customer service group stands ready to provide assistance to your call.

PROMPT DELIVERY

Direct from our stocking distributors, or alternatively, through one of Master Lock's ISO-9001 certified facilities, our stock product distribution center or special product 'Make-to-Order' factory.

You can trust Master Lock for the products, security, support and service you need.

CONTENTS

Commercial Security Innovations	Page 3	General Security	Page 14
Padlock Keying Security	Page 4 – 5	Key-In-Knob and Interchangeable Core	Page 15
Master Lock® Vault Enterprise	Page 6 – 7	Locker Locks	Page 16 – 18
Commercial Magnum®	Page 8	Safety Lockout	Page 19 – 20
ProSeries® High Security	Page 9	Flexible Security	Page 21
ProSeries® All Weather	Page 10	Hasps	Page 22
ProSeries® Resettables	Page 11	Fleet Security	Page 23
General Security Rekeyables	Page 12	Key Security and Specialty	Page 24
General Security Non-Rekeyables	Page 13		

COMMERCIAL SECURITY INNOVATIONS

MASTER LOCK® VAULT ENTERPRISE

ADVANCED SECURITY AND ACCESS-MANAGEMENT SYSTEM

See pages 6 and 7



COMMERCIAL MAGNUM® PADLOCKS

STRONGER DEFENSE AGAINST THE ELEMENTS

See page 8



RESETTABLE COMBINATION PADLOCKS

HEAVY-DUTY COMBINATION DIAL SECURITY

See pages 11 and 14



LOCKER LOCKS

ELEVATE THE LOCKER ROOM EXPERIENCE

See page 16



BUMPSTOP® ADVANCED CYLINDER TECHNOLOGY

LOCK BUMPING SOLUTION

See page 5

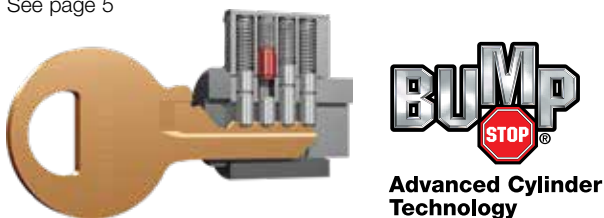

EDGE® KEY CONTROL

ELIMINATES UNAUTHORIZED KEY DUPLICATION

See page 5

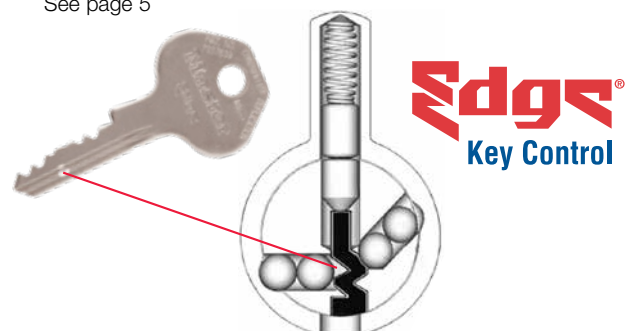

PADLOCK KEYING SECURITY

ESTABLISHING A SAFE, SECURE AND CONVENIENT LOCKING SYSTEM

Keying Security is Equally Important to Physical Security in Commercial Security Applications

Keying security includes the security designed into the padlock's cylinder and operating key, and the way in which the product is supplied to the marketplace. Master Lock stands alone among padlock suppliers in both categories of keying security:

- Master Lock provides the largest range of tight-tolerance cylinders and keys that vastly eliminate unwanted key interchange. This helps to ensure one employee's key will not be able to inadvertently open a second lock.
- Master Lock offers key control services, and charted and reserved systems, all of which assure that your company's padlocking system maintains the utmost in key integrity, even as you reorder padlocks. This means that additional padlocks ordered can all be specified to operate by distinct keys, if that is your requirement.



Establishing an Optimal Padlock Security System

Evaluate Your Present & Future Needs:

- Do you want each padlock to have a different operating key? Specify keyed different (KD) padlocks.
- Do you want groups of padlocks to be opened by a single key? If so, order keyed alike (KA) padlocks. For example, it is often desirable for each employee to have their own set of keyed-alike locks.
- Do you want a supervisor to be able to open a range of keyed-different padlocks? Order master keyed (MK) locks. See "Master Keying" section for more information.
- How many padlocks will you need? If you require thousands of distinct operating keys, with no repeats, you will want to specify a Master Lock commercial security padlock with a 5-pin or 6-pin cylinder. See "Key System Capacity" for more information.
- Do you want your padlock to be opened by the same key that opens your door lock? You can!

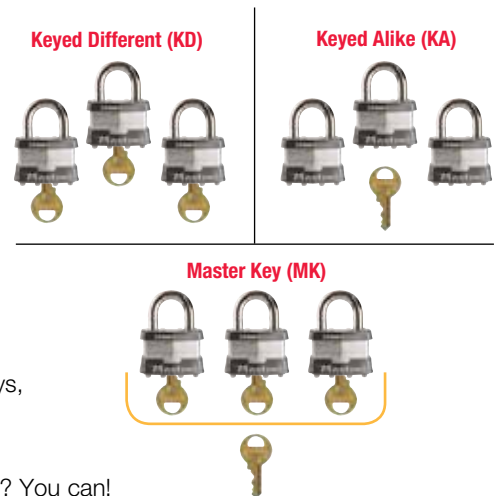

Master Keying

Master keyed (MK) locks have to be ordered as such initially. Locks are not automatically pre-set so that a master key can later operate them. When you initiate a master-keyed lock system, you should also identify how large and complex the system might eventually become.

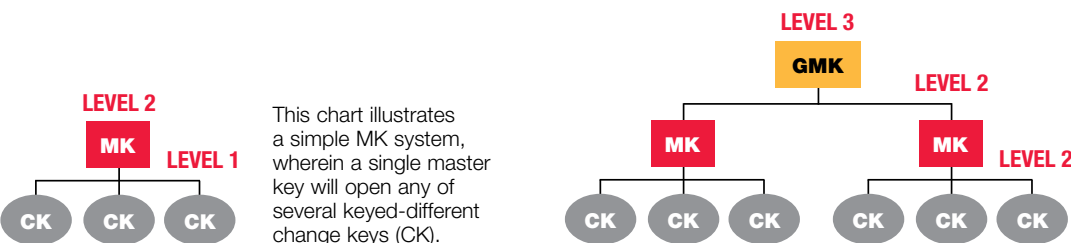

This chart illustrates a simple MK system, wherein a single master key will open any of several keyed-different change keys (CK).

Many MK systems provide additional levels of control, as diagrammed here. The level 3 grand master key (GMK), held by the security director, would open all locks throughout the system.

Lock Bumping Solution

Lock bumping has become a recognized method of violating most in-line pin tumbler cylinders. In response, The Master Lock Company stepped forward to create a revolutionary new lock cylinder that provides excellent protection against lock bumping, as established in the ASTM Standard F883-09. Our BumpStop® solution employs an innovative, patent-pending design which utilizes a unique reverse-rake tapered driver pin, high-performance springs, and precision-tolerance chambers. During a bump attempt, this solution prevents the transfer of force from the bump key to the pins and blocks rotation of the cylinder – so the lock stays locked. This feature is available in a broad range of Master Lock padlocks and door hardware and can be ordered by adding an “N” to the product number. Example: 6121N (vs. 6121), 3N (vs. 3).

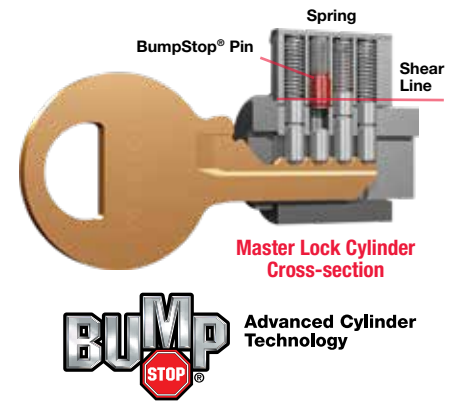

Key Control Options

The patented Edge® Key Control System provides absolute key control, eliminating the risk of unauthorized key duplication. The innovative and exclusive cylinder design has an additional locking feature to increase security. Edge® is available in the full range of Master Lock commercial laminated and ProSeries® padlocks.

Restricted Keyways Key blanks are not sold. Cut keys are only available from the factory for charted systems. Master Lock maintains restricted key systems specifically for safety lockout padlocks, where safeguarding employees is the absolute priority.

Reserved Keyways The factory limits key blank distribution to specific customers. Cut keys are not readily available. Master Lock offers reserved key systems (RSV) for its complete ProSeries® and laminated product lines for commercial applications.

Charting Services Master Lock will keep a complete record of the progressive key codes assigned and manufactured into a customer’s padlocks for each order. Request this special service to receive a Commercial User ID number to reference on all subsequent orders. Any order submitted with the Commercial User ID will be manufactured to comply with the facility’s key system requirements.

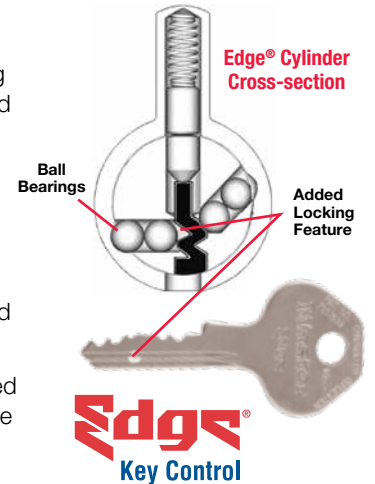

Matching Your Security Door Lock Keys

The versatile ProSeries® line can also be ordered to operate with the same keys used in your current door security system. This can greatly increase convenience (fewer keys to carry) and security (padlocks operate with the same high-security, controlled keys). ProSeries® can integrate with door security systems from Schlage®, Yale®, Kwikset®, Corbin®, Weiser®, Sargent®, Russwin® and Weslock®; even interchangeable core keyways by Best®, Arrow™ and Falcon®...many popular keyways available!

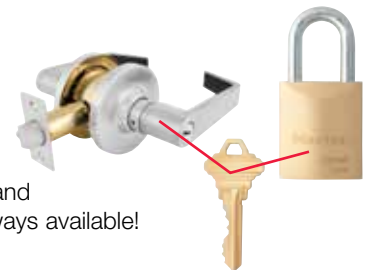

Key System Capacity

All cylinders have limits to the number of change keys that can be provided. Be aware that whenever KD padlocks are supplied from open stock, the possibility exists that two or more locks provided will have the same operating key. This possibility of overlap increases as additional non-charted (see Charting Service) stock orders are received. It is important to know the key change limits of the padlocks you are considering for your security system. If the supplier does not, or can not, provide this information, the integrity of your keying system may be suspect.

This chart identifies the change key ranges of standard BumpStop® technology padlock cylinders.

PADLOCK SERIES	MODEL NUMBERS	# OF KEY CHANGES IN KD SYSTEM	# OF KEY CHANGES IN MK SYSTEM
Edge® 6 Pin	WP6 in Master Lock	90,000	6,000
Edge® 4 Pin	WP4 in Master Lock	1,200	140
ProSeries® 6 Pin	6100's, 6300's, 6800's, 7000's	90,000	10,100
ProSeries® 5 Pin	6100's, 6300's, 6800's, 7000's	14,200	1,300
Safety Lockout	410, 406, 411, S30, S6835	40,000	140
5 Pin Laminated Pin Tumbler	21, 31, 81 & others	14,200	1,300
4 Pin Laminated Pin Tumbler	1, 2, 3, 4, 5, 6 & others	1,200	248
Small 4 Pin Laminated Pin Tumbler	7, 8 & others	800	160

Quantities listed in the last two columns are actual quantities of keys available. Mathematically there are many more keys that can be calculated but may have been eliminated because they are undesirable or create a mechanical limitation. For additional models and key change information, contact Master Lock Company Customer Care.

Consulting & Support

Master Lock’s customer service staff and field sales representatives are qualified and ready to help you establish a safe and convenient padlock security system for your company. Call or visit the Master Lock website to get started on the path to effective keying security.

MASTER LOCK® VAULT ENTERPRISE

ADVANCED SECURITY AND ACCESS MANAGEMENT SYSTEM

The Master Lock Vault Enterprise software and suite of *Bluetooth*® enabled hardware provide business users who manage many locks and many users with a convenient way to control access, manage assets and improve accountability. This proven security innovation eliminates the cost, security risk and complexity of physical keys.



Innovative Features

- Efficiently manage access to ensure the right users have the right access
- Simplify security set-up with bulk user uploads and fast lock scanning for registration
- Automatically map lock and lock box locations via smartphone
- Easily monitor access with robust data and audit trails
- Assured back-up entry method using manual, directional or numeric code on hardware
- Leverage the security of 256-bit, military-grade encryption



FLEXIBLE ASSET MANAGEMENT

Whether it's one lock or thousands, Master Lock Vault Enterprise provides businesses with unmatched security, simplicity and accountability.

INDIVIDUAL

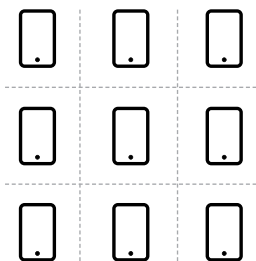

Share permanent or temporary access with our app that turns smartphones into smart keys.

GROUP

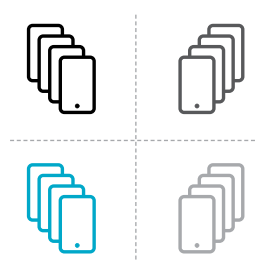

Easily assign users and devices to unique access groups, on demand.

CUSTOMIZED

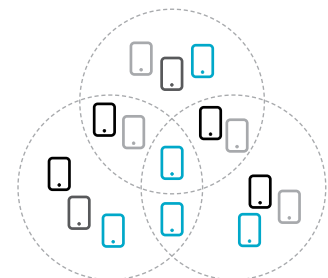

Enjoy system-wide customization, including the ability to overlay groups for efficient access management.

AROUND THE CLOCK ACCESS

Integrated into the suite of Bluetooth enabled products, the easy-to-use Master Lock Vault Enterprise app eliminates the need for physical keys and key management, lowering costs and enhancing security. Users view detailed lock-use history, including unlock, open and relock activity.



GRANT ACCESS >



BY TIME



BY DATE



BY USER



BY GROUP

BLUETOOTH ENABLED PRODUCTS

The Master Lock Vault Enterprise suite of Bluetooth enabled products can be mixed and matched to fit application needs.

Bluetooth Padlocks

- Durable, reliable padlocks that feature anti-shim technology for maximum security
- No keys to use
- No combinations to forget
- No unauthorized key duplication



MASTER LOCK MODEL#	DESCRIPTION	VERTICAL SHACKLE CLEARANCE (B)
4400ENT	Indoor Use, 1-29/32in (47mm) body. Shackle Dim.: A: 9/32in (7mm) C: 13/16in (20mm)	7/8in (22mm)
4401LHENT	Outdoor Use, 1-3/4in (44mm) body. Shackle Dim.: A: 11/32in (9mm) C: 15/16in (23mm)	2in (51mm)

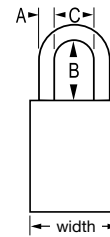

Bluetooth Lock Boxes

- Strong, weather-resistant lock boxes have a large storage capacity for keys and key cards
- No long-term contracts
- No monthly fees
- No shared access fees



MASTER LOCK MODEL#	DESCRIPTION	VERTICAL SHACKLE CLEARANCE (B)
5440ENT	Electronic portable lock box, 2-3/16in body. Shackle Dim.: A: 13/32in (10mm) C: 1-13/32in (36mm)	1-13/16in (46mm)
5441ENT	Electronic wall mount lock box, 2-3/16in body.	NA

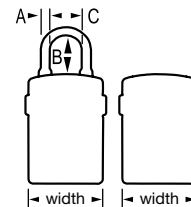

COMMERCIAL MAGNUM®

COMMERCIAL MAGNUM® PADLOCKS

MAGNUM®

Commercial Magnum® offers a stainless-steel-encased, laminated steel body, which provides weatherability and security for applications in outdoor, corrosive and caustic environments. The dual-ball bearing locking mechanism has maximum resistance against prying and hammering. A chrome-plated, boron-carbide octagonal shackle impedes cutting and sawing.

MASTER LOCK MODEL #	DESCRIPTION	VERTICAL SHACKLE CLEARANCE (B)
M1STS	1-3/4in (44mm) wide, A = 5/16in (8mm), C = 13/16in (21mm)	1in (25mm)
M1LFSTS	1-3/4in (44mm) wide, 1-1/2in (38mm) Shackle, A = 5/16in (8mm), C = 13/16in (21mm)	1-1/2in (38mm)
M1LJSTS	1-3/4in (44mm) wide, 2-1/2in (64mm) Shackle, A = 5/16in (8mm), C = 13/16in (21mm)	2-1/2in (64mm)
M1KASTS	1-3/4in (44mm) wide, A = 5/16in (8mm), C = 13/16in (21mm), Keyed Alike	1in (25mm)
M1KALFSTS	1-3/4in (44mm) wide, 1-1/2in (38mm) Shackle, A = 5/16in (8mm), C = 13/16in (21mm), Keyed Alike	1-1/2in (38mm)
M1KALJSTS	1-3/4in (44mm) wide, 2-1/2in (64mm) Shackle, A = 5/16in (8mm), C = 13/16in (21mm), Keyed Alike	2-1/2in (64mm)
M5STS	2in (51mm) wide, A = 3/8in (10mm), C = 15/16in (24mm)	1in (25mm)
M5LFSTS	2in (51mm) wide, 1-1/2in (38mm) Shackle, A = 3/8in (10mm), C = 15/16in (24mm)	1-1/2in (38mm)
M5LJSTS	2in (51mm) wide, 2-1/2in (64mm) Shackle, A = 3/8in (10mm), C = 15/16in (24mm)	2-1/2in (64mm)
M5KASTS	2in (51mm) wide, A = 3/8in (10mm), C = 15/16in (24mm), Keyed Alike	1in (25mm)
M5KALFSTS	2in (51mm) wide, 1-1/2in (38mm) Shackle, A = 3/8in (10mm), C = 15/16in (24mm), Keyed Alike	1-1/2in (38mm)
M5KALJSTS	2in Wide (51mm) Commercial Magnum, 2-1/2in (64mm) Shackle, Keyed Alike	2-1/2in (64mm)

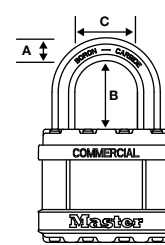

M1KASTS

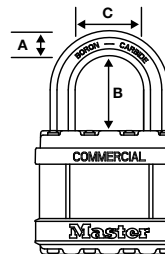

M5KALJSTS



Octagonal boron-carbide shackle is 50% harder than hardened steel

Chrome-plated shackle for excellent rust resistance

Stainless steel body cover for exceptional weatherability

Superior pry resistance with dual-ball bearing locking

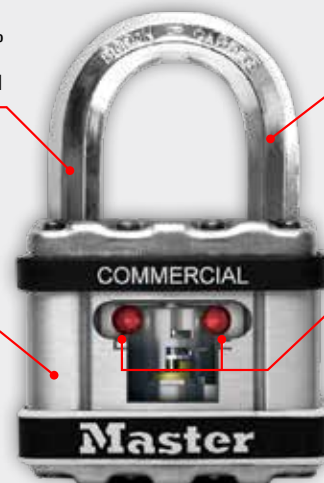

- Key to match existing 4-pin W1 systems
- Edge® Key Control available

PROSERIES® HIGH SECURITY

PROSERIES® HIGH-SECURITY PADLOCKS

- Greatest physical security available:
 - Heavy steel bodies
 - Hardened steel and boron-alloy shackles for superior cut resistance
 - Dual deadbolt locking for extreme resistance to prying
- Rekeyable – replaceable cylinder and shackle
- High key security:
 - 5-pin tumbler ProSeries® cylinders provide tens of thousands of key changes
 - Special spool pins are virtually impossible to pick

Solid Iron Shroud

- Greatest security against bolt cutters
- Proprietary rustproofing for longer life
- Defeats attempts to pry and cut

MASTER LOCK MODEL#	DESCRIPTION	VERTICAL SHACKLE CLEARANCE (B)
6321	2-1/8in (54mm) w. Body. Shackle Dim.: A: 5/16in (8mm) C: 7/8in (22mm)	3/4in (19mm)
6325	2-3/8in (60mm) w. Body. Shackle Dim.: A: 3/8in (10mm) C: 7/8in (22mm)	3/4in (19mm)
6327	2-5/8in (67mm) w. Body. Shackle Dim.: A: 7/16in (11mm) C: 7/8in (22mm)	3/4in (19mm)

KEYING OPTIONS:	KD-Keyed Different (default option), KA-Keyed Alike, MK-Master Keyed, N-BumpStop® Advanced Cylinder Technology, WP4-Edge® Key Control 4-pin and WP6-Edge® Key Control 6-pin cylinders
------------------------	---

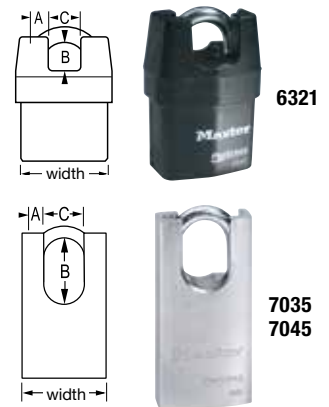

Solid Steel

- Outstanding protection against physical attacks
- Chrome rustproofing provides longer life
- Shrouded & hidden shackle models defy bolt cutters and prying

MASTER LOCK MODEL#	DESCRIPTION	VERTICAL SHACKLE CLEARANCE (B)
7030	1-9/16in (40mm) w. Body. Shackle Dim.: A: 1/4in (6mm) C: 25/32in (20mm)	1-1/16in (27mm)
7035	1-9/16in (40mm) w. Body, Shrouded. Shackle Dim.: A: 1/4in (6mm) C: 25/32in (20mm)	1-1/16in (27mm)
7040	1-3/4in (44mm) w. Body. Shackle Dim.: A: 5/16in (8mm) C: 29/32in (23mm)	1-3/16in (30mm)
7045	1-3/4in (44mm) w. Body, Shrouded. Shackle Dim.: A: 5/16in (8mm) C: 29/32in (23mm)	1-3/16in (30mm)
7050	2in (51mm) w. Body. Shackle Dim.: A: 3/8in (10mm) C: 29/32in (23mm)	1-1/2in (38mm)
6230	2-1/2in (63mm) w. Body. Shackle Dim.: A: 7/16in (11mm) C: 7/8in (22mm)	1-1/8in (29mm)
6271	2-7/8in (73mm) w. Reinforced Die Cast Body. Hidden 3/8in (10mm) Diameter Shackle: Stepped Back	n/a
770	9in (23mm) w. x 4-1/2in (11.4cm) High Solid Steel Hasp. Use With 6270 and 6271 Locks	n/a

KEYING OPTIONS:	KD-Keyed Different (default option), KA-Keyed Alike, MK-Master Keyed, N-BumpStop® Advanced Cylinder Technology, WP4-Edge® Key Control 4-pin and WP6-Edge® Key Control 6-pin cylinders
------------------------	---

SHACKLE OPTIONS:	LF = 1-9/16in (40mm) – Lock Model 7030 LH = 2in (51mm) – Lock Model 6230 LJ = 2-1/2in (63mm) – Lock Models 7040, 7050 LT = 3in (72mm) – Lock Model 7030
-------------------------	--

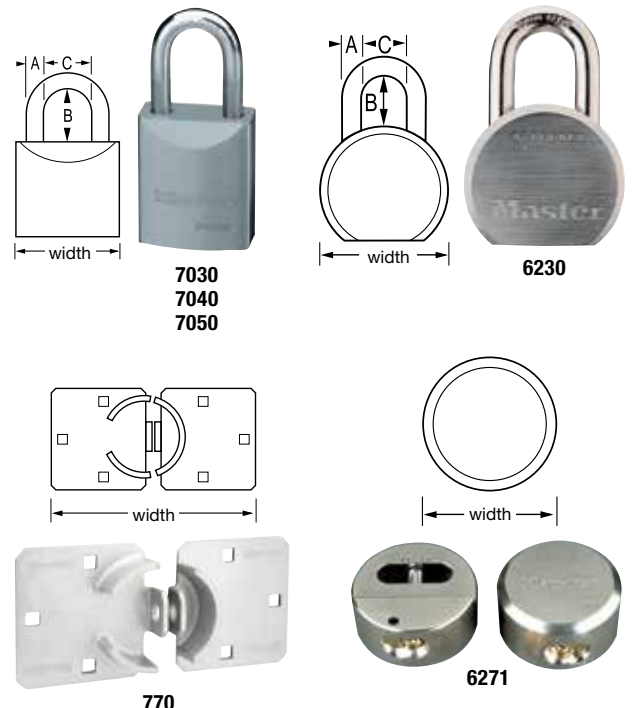

PROSERIES® ALL WEATHER

PROSERIES® ALL-WEATHER PADLOCKS

- For extreme conditions and corrosive environments
- Hardened steel and boron-alloy shackles for superior cut resistance
- Dual deadbolt locking for extreme resistance to prying
- High key security:
 - 5-pin tumbler ProSeries® cylinders provide tens of thousands of key changes
 - Special spool pins are virtually impossible to pick
- Rekeyable – replaceable cylinder and shackle



Weather Tough®

- Exclusive cover protects lock from water, ice, dirt and grime
- Heavy steel bodies withstand physical attacks
- Keyway cover keeps out dust and dirt

MASTER LOCK MODEL#	DESCRIPTION	VERTICAL SHACKLE CLEARANCE (B)
6121	2-1/8in (54mm) w. Body. Shackle Dim.: A: 5/16in (8mm) C: 7/8in (22mm)	1-1/8in (29mm)
6125	2-3/8in (61mm) w. Body. Shackle Dim.: A: 3/8in (10mm) C: 7/8in (22mm)	1-3/8in (35mm)
6127	2-5/8in (67mm) w. Body. Shackle Dim.: A: 7/16in (11mm) C: 7/8in (22mm)	1-3/8in (35mm)

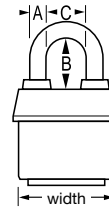

KEYING OPTIONS:	KD-Keyed Different (default option), KA-Keyed Alike, MK-Master Keyed, N-BumpStop® Advanced Cylinder Technology, WP4-Edge® Key Control 4-pin and WP6-Edge® Key Control 6-pin cylinders
------------------------	---

SHACKLE OPTIONS:	LH = 2in (51mm) – Lock Model 6127 LJ = 2-1/2in (63mm) – Lock Models 6121, 6125, 6127 LF = 1-1/2in (39mm) – Lock Model 6121
-------------------------	--

COLOR OPTIONS:	Lock Model 6121 now available in 6 vibrant colors. Add Desired Color Suffix: RED, ORJ, YLW, GRN, BLU, WHT
-----------------------	--



Solid Brass

- Solid brass body provides extra corrosion resistance
 - Optional brass shackles available for 100% corrosion resistance

MASTER LOCK MODEL#	DESCRIPTION	VERTICAL SHACKLE CLEARANCE (B)
6830	1-9/16in (40mm) w. Body. Shackle Dim.: A: 1/4in (6mm) C: 25/32in (20mm)	1-1/16in (27mm)
6840	1-3/4in (44mm) w. Body. Shackle Dim.: A: 5/16in (8mm) C: 29/32in (23mm)	1-3/16in (30mm)
6850	2in (51mm) w. Body. Shackle Dim.: A: 3/8in (10mm) C: 29/32in (23mm)	1-1/2in (38mm)

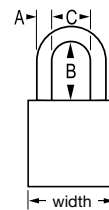

KEYING OPTIONS:	KD-Keyed Different (default option), KA-Keyed Alike, MK-Master Keyed, N-BumpStop® Advanced Cylinder Technology, WP4-Edge® Key Control 4-pin and WP6-Edge® Key Control 6-pin cylinders
------------------------	---

SHACKLE OPTIONS:	LF = 1-9/16in (40mm) – Lock Model 6830 LJ = 2-1/2in (63mm) – Lock Models 6840, 6850 LT = 3in (72mm) – Lock Models 6830
-------------------------	--



PROSERIES® RESETTABLES

PROSERIES® RESETTABLE COMBINATION PADLOCKS

- Octagonal boron-carbide shackle for superior cut resistance
- Dead locking mechanism protects against prying, shimming and rap attacks
- Shackle seal and dial dust cover protect internal components and dials for trouble-free operation
- Durable brass, stainless or die-cast bodies withstand the elements
- Stainless-steel shackle available for ultimate corrosion resistance
- Set-your-own 4-digit combination dial with 10,000 possible combinations

MASTER LOCK MODEL#	DESCRIPTION	VERTICAL SHACKLE CLEARANCE (B)
1174	2-1/4in (57mm) w. stainless steel body. Stainless Steel Shackle Dim.: A: 5/16in (8mm) C: 1in (25mm)	1-1/16in (28mm)
1175	2-1/4in (57mm) w. brass body. Shackle Dim.: A: 3/8in (10mm) C: 15/16in (24mm)	1-1/16in (28mm)
1177	2-1/4in (57mm) w. shrouded brass body. Shackle Dim.: A: 3/8in (10mm) C: 15/16in (24mm)	1-1/16in (28mm)
1178	2-1/4in (57mm) w. diecast body. Shackle Dim.: A: 3/8in (10mm) C: 15/16in (24mm)	1-1/16in (28mm)
1175 SHACKLE OPTIONS:	LH = 2-1/16in (53mm) LHRS = 2-1/16in (53mm) Round A: 5/16in (8mm) LHSS = 2-1/16in (53mm) Round, Stainless Steel A: 5/16in (8mm) RS = 1-1/16in (28mm) Round A: 5/16in (8mm)	

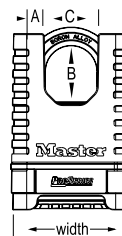

GENERAL SECURITY REKEYABLES

GENERAL SECURITY REKEYABLE PADLOCKS

- A rekeyable padlock allows you to quickly remove an old cylinder and either change the pins or replace it
- 5-pin cylinder standard for all rekeyable padlocks
- Double ball-bearing locking mechanisms provide extra pry resistance
- Save money and replace cylinders instead of locks
- Rekeying kit contains an extensive assortment of the most frequently used components to replace or rekey cylinders, including ProSeries® locks
- Extra reach lock (no. 101) is ideal for wide-span applications, like commercial refrigerators



MASTER LOCK MODEL #	LAMINATED STEEL DESCRIPTION	VERTICAL SHACKLE CLEARANCE (B)
21	1-3/4in (44mm) w. Body. Shackle Dim.: A: 5/16in (8mm) C: 3/4in (19mm)	15/16in (24mm)
25	2in (51mm) w. Body. Shackle Dim.: A: 3/8in (10mm) C: 15/16in (24mm)	1in (25mm)
101	3-1/4in (83mm) w. Body. Shackle Dim.: A: 5/16in (8mm) C: 2-1/4in (57mm)	3in (76mm)

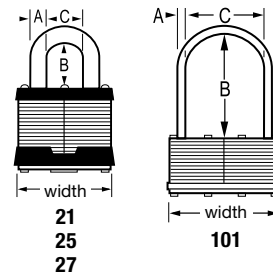

MASTER LOCK MODEL #	SOLID ZINC, DIE-CAST DESCRIPTION	VERTICAL SHACKLE CLEARANCE (B)
220	2in (51mm) w. Body. Shackle Dim.: A: 7/16in (11mm) C: 3/4in (19mm)	1in (25mm)
230	2-1/2in (63mm) w. Body. Shackle Dim.: A: 7/16in (11mm) C: 15/16in (24mm)	1in (25mm)

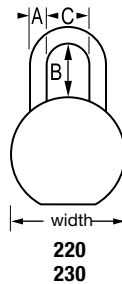

KEYING OPTIONS:	KD-Keyed Different (default option), KA-Keyed Alike, MK-Master Keyed, N-BumpStop® Advanced Cylinder Technology, WP4-Edge® Key Control 4-pin cylinder
------------------------	--

SHACKLE OPTIONS:	LF = 1-1/2in (38mm) – Lock Model 21 LH = 2in (51mm) – Lock Models 220, 230 LJ = 2-1/2in (63mm) – Lock Model 21
-------------------------	--

291	Pin Tumbler Rekeying Parts Kit	n/a
-----	--------------------------------	-----

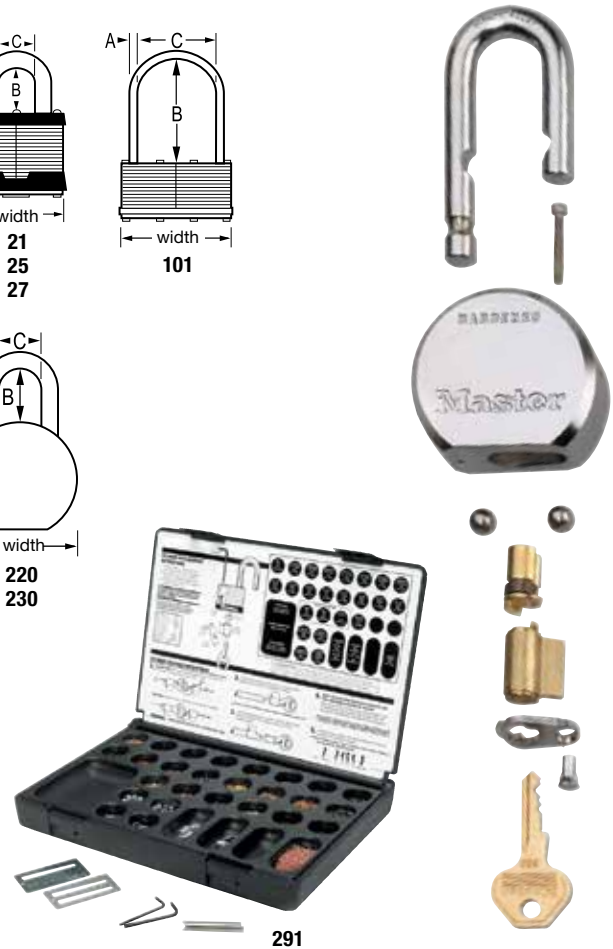

GENERAL SECURITY NON-REKEYABLES

GENERAL SECURITY NON-REKEYABLE PADLOCKS

- Reinforced laminated lock bodies
- Double ball-bearing locking mechanisms provide extra pry resistance (1-1/8in (28mm) bodies are single locking)

Laminated Steel

- For perimeter and storefront gates, tool cribs, construction equipment, vending and truck doors, general use
- Hardened-steel and alloy shackles for extra cut resistance (1-1/8in (28mm) body shackles are not hardened)
- Proprietary rustproofing for longer life
- Full range of sizes to best secure your applications



MASTER LOCK MODEL#	DESCRIPTION	VERTICAL SHACKLE CLEARANCE (B)
7	1-1/8in (28mm) w. Body. Shackle Dim.: A: 3/16in (5mm) C: 1/2in (13mm)	9/16in (14mm)
3	1-9/16in (40mm) w. Body. Shackle Dim.: A: 9/32in (7mm) C: 5/8in (16mm)	3/4in (19mm)
1	1-3/4in (44mm) w. Body. Shackle Dim.: A: 5/16in (8mm) C: 3/4in (19mm)	15/16in (24mm)
5	2in (51mm) w. Body. Shackle Dim.: A: 3/8in (10mm) C: 15/16in (24mm)	1in (25mm)

KEYING OPTIONS:	KD-Keyed Different (default option), KA-Keyed Alike, MK-Master Keyed, N-BumpStop® Advanced Cylinder Technology, WP4-Edge® Key Control 4-pin cylinder
------------------------	--

SHACKLE OPTIONS:	LF = 1-1/2in (38mm) – Lock Models 7, 3, 1, 5 LH = 2in (51mm) – Lock Models 3, 17, 15 LJ = 2-1/2in (63mm) – Lock Models 7, 1, 5 LN = 5-3/4in (15cm) – Lock Model 1
-------------------------	--

- Pin tumbler key security: 4 and 5-pin cylinders
- Master keyed and reserved systems available
- Thousands of key changes

Laminated Brass

- Excellent for outdoor use and marine environments
- Brass bodies and cylinders provide excellent corrosion resistance
- Available brass shackles for maximum corrosion resistance
- Hardened chrome-plated steel shackles for extra cut resistance

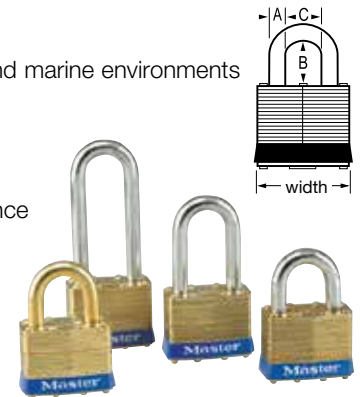

MASTER LOCK MODEL#	DESCRIPTION	VERTICAL SHACKLE CLEARANCE (B)
8	1-1/8in (28mm) w. Body. Shackle Dim.: A: 3/16in (5mm) C: 1/2in (13mm)	9/16in (14mm)
4	1-9/16in (40mm) w. Body. Shackle Dim.: A: 9/32in (7mm) C: 5/8in (16mm)	3/4in (19mm)
2	1-3/4in (44mm) w. Body. Shackle Dim.: A: 5/16in (8mm) C: 3/4in (19mm)	15/16in (24mm)
6	2in (51mm) w. Body. Shackle Dim.: A: 3/8in (10mm) C: 15/16in (24mm)	1in (25mm)

KEYING OPTIONS:	KD-Keyed Different (default option), KA-Keyed Alike, MK-Master Keyed, N-BumpStop® Advanced Cylinder Technology, WP4-Edge® Key Control 4-pin cylinder
------------------------	--

SHACKLE OPTIONS:	LF = 1-1/2in (38mm) – Lock Models 8, 4, 2, 6 LH = 2in (51mm) – Lock Models 4 LJ = 2-1/2in (63mm) – Lock Models 8, 2, 6 B = Brass Shackle – Lock Models 8, 4, 2, 6
-------------------------	--



GENERAL SECURITY

Resettable Combination

- Use combination reset feature to restrict/change allowed access
- 4-digit direct-dial operation – reset to any of 10,000 combinations (Nos. 878 & 975 require no reset tool)
- Heavy hardened shackle provides high resistance to cutting and prying
- Solid case for strength and weatherability
- No. 176 with key override feature for supervisory access
- No. 878 & 975 feature dead-locking mechanism to protect against prying, shimmying and rap attacks

MASTER LOCK MODEL #	DESCRIPTION	VERTICAL SHACKLE CLEARANCE (B)
175	2in (51mm) w. Solid Brass Case. Shackle Dim.: A: 5/16in (8mm) C: 1in (25mm)	1in (25mm)
175DWD	175 w/4-Digit Letter Combination Padlock	1in (25mm)
176	Key Override, 2in (51mm) w. Solid Brass Case. Shackle Dim.: A: 5/16in (8mm) C: 1in (25mm)	7/8in (22mm)
178BLK	Die-Cast Black, 2in (51mm) w. Solid Brass Case. Shackle Dim.: A: 5/16in (8mm) C: 1in (25mm)	1in (25mm)
878	Powder Coated Black, 2in (51mm) w. Solid Zinc Case. Shackle Dim.: A: 5/16in (8mm) C: 1in (25mm)	1in (25mm)
975	2in (51mm) w. Solid Brass Case. Shackle Dim.: A: 5/16in (8mm) C: 1in (25mm)	1in (25mm)



SHACKLE OPTIONS: LH = 2in (51mm) – Lock Model 975; 2-1/4in (57mm) – Lock Models 175, 176

Economy Steel

- For applications requiring basic tamper resistance: well covers, dumpsters and low-valued property
- Laminated steel body withstands physical abuse
- Rustproofed for extended wear
- Warded locking mechanism minimizes binding from dirt and grime
- Nos. 510D and 517D feature removable adjustable shackles

MASTER LOCK MODEL #	DESCRIPTION	VERTICAL SHACKLE CLEARANCE (B)
10D	1in (25mm) w. Body. Shackle Dim.: A: 5/32in (4mm) C: 13/32in (10mm)	7/16in (11mm)
105D	1-1/8in (28mm) w. Body. Shackle Dim.: A: 3/16in (5mm) C: 1/2in (13mm)	1/2in (13mm)
22	1-1/2in (38mm) w. Body. Shackle Dim.: A: 1/4in (6mm) C: 9/16in (14mm)	5/8in (16mm)
500	1-3/4in (44mm) w. Body. Shackle Dim.: A: 9/32in (7mm) C: 13/16in (21mm)	13/16in (21mm)
500KABRK	1-3/4in (44mm) w. Body. Shackle Dim.: A: 9/32in (7mm) C: 13/16in (21mm) Breakaway Shackle	
510D	1-3/4in (44mm) w. Body. Shackle Dim.: A: 9/32in (7mm) C: 13/16in (21mm)	5/8in – 2in (16mm–51mm)
517D	1-3/4in (44mm) w. Body. Shackle Dim.: A: 9/32in (7mm) C: 13/16in (21mm)	2-3/4in – 5-3/8in (7cm – 14cm)

SHACKLE OPTIONS: LF = 1-1/2in (38mm) – Lock Model 22

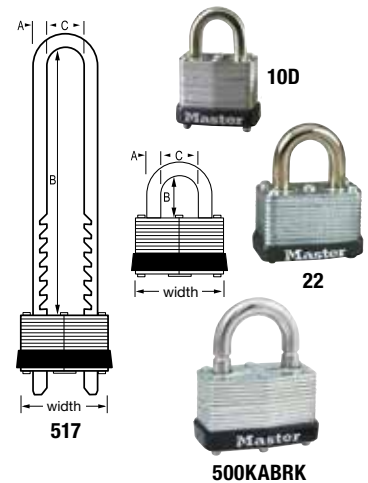

Economy Brass Series

- Brass bodies and cylinders provide extra corrosion resistance
- Pin-tumbler cylinders provide greater pick resistance

MASTER LOCK MODEL #	DESCRIPTION	VERTICAL SHACKLE CLEARANCE (B)
4120	3/4in (19mm) w. Body. Shackle Dim.: A: 5/32in (4mm) C: 3/8in (10mm)	7/16in (11mm)
4130	1-1/8in (28mm) w. Body. Shackle Dim.: A: 3/16in (5mm) C: 9/16in (14mm)	9/16in (14mm)
4140	1-1/2in (38mm) w. Body. Shackle Dim.: A: 1/4in (6mm) C: 13/16in (20mm)	13/16in (20mm)
4150	1-7/8in (47mm) w. Body. Shackle Dim.: A: 9/32in (7mm) C: 1in (25mm)	15/16in (24mm)

KEYING OPTIONS: KA-Keyed Alike

SHACKLE OPTIONS: LF = 1-1/2in (38mm) – Lock Model 4130; LH = 2in (51mm) – Lock Model 4140; LJ = 2-1/2in (63mm) – Lock Model 4130, 4150

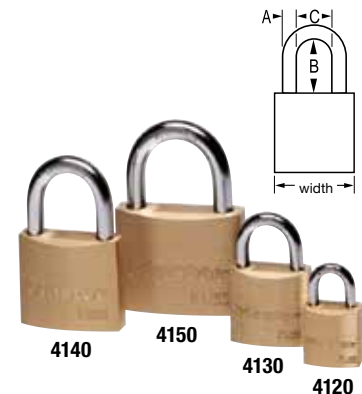

KEY-IN-KNOB AND INTERCHANGEABLE CORE

KEY-IN-KNOB AND INTERCHANGEABLE CORE PADLOCKS

- With your existing records, Master Lock can re-create and expand your current key system
- Cylinders may be ordered both separately, keyed up and ready to plug into your system or as part of a complete Master Lock door-key-compatible padlock assembly



Key-In-Knob

- Use the same key that opens your door
- Padlock bodies accept the following OEM cylinders: Medeco® #20W20000 6-pin cylinder, Schlage® (6-pin Key-in-Knob), Assa® (65611), Lori® #1539, Schlage® Primus® and GMS® cylinders

MASTER LOCK MODEL#	DESCRIPTION	VERTICAL SHACKLE CLEARANCE (B)
6727	2-5/8in (67mm) w. Solid Iron Shroud Body. Shackle Dim.: A: 7/16in (11mm) C: 7/8in (22mm)	3/4in (19mm)
6721	2-1/8in (54mm) w. Solid Iron Shroud Body. Shackle Dim.: A: 5/16in (8mm) C: 7/8in (22mm)	3/4in (19mm)
7052	2in (51mm) w. Solid Steel Body. Shackle Dim.: A: 3/8in (9mm) C: 29/32in (23mm)	1-1/2in (37mm)
7042	1-3/4in (44mm) w. Solid Steel Body. Shackle Dim.: A: 5/16in (8mm) C: 29/32in (23mm)	1-3/16in (30mm)
7047	2-1/8in (54mm) w. Solid Steel Shrouded Body. Shackle Dim.: A: 5/16in (8mm) C: 29/32in (23mm)	1-3/16in (30mm)
6627	2-5/8in (67mm) w. Weather Tough® Body. Shackle Dim.: A: 7/16in (11mm) C: 7/8in (22mm)	1-3/8in (35mm)
6621	2-1/8in (54mm) w. Weather Tough® Body. Shackle Dim.: A: 5/16in (8mm) C: 7/8in (22mm)	1-1/8in (29mm)
6852	2in (51mm) w. Solid Brass Body. Shackle Dim.: A: 3/8in (9mm) C: 29/32in (23mm)	1-1/2in (37mm)
6842	1-3/4in (44mm) w. Solid Brass Body. Shackle Dim.: A: 5/16in (8mm) C: 25/32in (20mm)	1-3/16in (30mm)



Interchangeable Core

- Match your door security system – Accepts small format interchangeable core keyways from Best® and Arrow®
- Padlock bodies accept the following standard size OEM cores: Best®, Best® PKS®, Arrow®, Falcon®, Kaba®, Peaks®, KSP® and Lori®

MASTER LOCK MODEL#	DESCRIPTION	VERTICAL SHACKLE CLEARANCE (B)
6527	2-5/8in (67mm) w. Solid Iron Shroud Body. Shackle Dim.: A: 7/16in (11mm) C: 7/8in (22mm)	3/4in (19mm)
6521	2-1/8in (54mm) w. Solid Iron Shroud Body. Shackle Dim.: A: 5/16in (8mm) C: 7/8in (22mm)	3/4in (19mm)
7051	2in (51mm) w. Solid Steel Body. Shackle Dim.: A: 3/8in (9mm) C: 29/32in (23mm)	1-1/2in (37mm)
7041	1-3/4in (44mm) w. Solid Steel Body. Shackle Dim.: A: 5/16in (8mm) C: 29/32in (23mm)	1-3/16in (30mm)
7031	1-9/16in (40mm) w. Solid Steel Body. Shackle Dim.: A: 1/4in (8mm) C: 25/32in (20mm)	1-1/16in (27mm)
7046	1-3/4in (44mm) w. Shrouded Steel Body. Shackle Dim.: A: 5/16in (8mm) C: 29/32in (23mm)	1-3/16in (30mm)
7036	1-9/16in (40mm) w. Shrouded Steel Body. Shackle Dim.: A: 1/4in (8mm) C: 25/32in (20mm)	1-1/16in (27mm)
6427	2-5/8in (67mm) w. Weather Tough® Body. Shackle Dim.: A: 7/16in (11mm) C: 7/8in (22mm)	1-3/8in (35mm)
6421	2-1/8in (54mm) w. Weather Tough® Body. Shackle Dim.: A: 5/16in (8mm) C: 7/8in (22mm)	1-1/8in (29mm)
6851	2in (51mm) w. Solid Brass Body. Shackle Dim.: A: 3/8in (9mm) C: 29/32in (23mm)	1-1/2in (37mm)
6841	1-3/4in (44mm) w. Solid Brass Body. Shackle Dim.: A: 5/16in (8mm) C: 25/32in (20mm)	1-3/16in (30mm)
6831	1-9/16in (40mm) w. Solid Brass Body. Shackle Dim.: A: 1/4in (8mm) C: 25/32in (20mm)	1-1/16in (27mm)

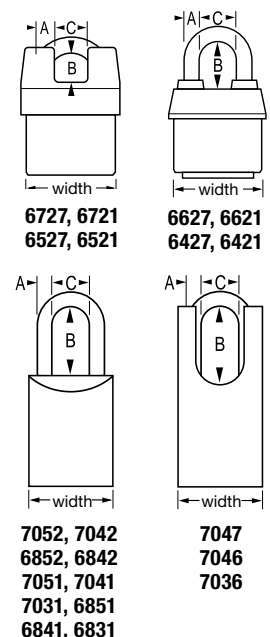

KEYING OPTIONS: KD-Keyed Different (default option), KA-Keyed Alike, MK-Master Keyed, KAMK-Keyed Alike and Master Keyed

MULTI-USER AND ELECTRONIC BUILT-INS

MULTI-USER AND ELECTRONIC BUILT-IN LOCKER LOCKS

Mechanical Multi-User

- Intuitive, easy-to-use design
- Set-your-own 3-digit combination
- Retains current combination until reset
- Sleek design with satin finish
- Designed for multiple users in a day for high customer turnover facilities
- Eliminates distribution, tracking and management of keys, combinations or locks
- Concealed mounting and rugged zinc case
- Override key allows quick supervisory access



MASTER LOCK MODEL #	DESCRIPTION
3630	Set-Your-Own combination lock – For standard lift handle lockers – manual deadbolt locking, right-hand hinged door – override key sold separately
3631	Set-Your-Own combination lock – For standard lift handle lockers – manual deadbolt locking, left-hand hinged door – override key sold separately
3670	Set-Your-Own combination lock – For lift handle, turn handle and single point latch/box horizontal latch lockers – manual deadbolt locking, right-hand or left-hand hinged door – Override Key sold separately

K3630	Supervisory override key
-------	--------------------------

Electronic

- High-visibility display provides clear locker vacancy status
- Electronic deadbolt locking
- Long battery life with 1 CR123A lithium battery
- Sensors provide visual and audible jam alerts
- Unique backup master code simplifies facility manager access
- Supports single and multi-user modes
- Optional admin key for easy locker checks and settings changes
- ADA-compliant model with *Bluetooth*® enabled fob available



MASTER LOCK MODEL #	DESCRIPTION
3685	Electronic deadbolt locking for single point latch lockers; left- or right-hand hinges
3681	Electronic deadbolt locking for single point latch lockers; left- or right-hand hinges; comes with Bluetooth fob for ADA compliance
1566	Optional administration key



MECHANICAL BUILT-INS

MECHANICAL BUILT-IN LOCKER LOCKS

- Standard key control provides quick supervisory access
- End-user registration assures key system integrity
- Control charts simplify administration (combination locks)
- Colored metal dials available on some models

Wrap-Around-Latch™ Built-In Combination and Key Operated Locks

- Uses the same technology as an automotive door lock system, utilizing slam shut operation combined with a rotating latch that wraps around the latch plate
- Designed for single point latch lockers
- Provides the most robust design and requires the least adjustment for proper operation

MASTER LOCK MODEL #	DESCRIPTION
1690	Automatic deadbolt locking for single point latch lockers. For doors with door hinges on the right.
1790	High Security Cylinder and Manual Deadbolt Locking
CNTLKEYBI	Control Key

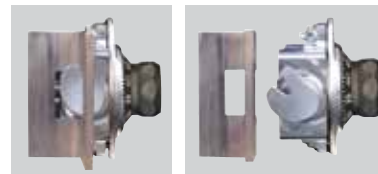

Locked

Unlocked



1690



1790

Built-In Combination Locks

- For lift handle, turn handle, single point latch and box lockers
- Concealed mounting and rugged steel case deter vandalism
- Longer, useful life with five different combinations which are easily changed for new students or employees to maintain security
- 3-digit combination is easy to dial

MASTER LOCK MODEL #	DESCRIPTION
Automatic Deadbolt Locking Mechanism for Lift Handle Lockers	
1630	For Lockers with Door Hinges on Right
1631	For Lockers with Door Hinges on Left
Automatic Springbolt Locking Mechanism for Single Point Latch Lockers	
1652	For Lockers with Door Hinges on Right
1653	For Lockers with Door Hinges on Left
Automatic Springbolt Locking Mechanism for Box Type Lockers	
1654	For Lockers with Door Hinges on Right
1655	For Lockers with Door Hinges on Left
Manual Deadbolt Locking Mechanism for All Types of Lockers	
1670	For Lockers with Door Hinges on Right
1671	For Lockers with Door Hinges on Left
CNTLKEYBI	Control Key



1630/1631

1652/1653



1654/1655

1670/1671



All-Purpose Key Operated Locks

- Built-in locks for all locker applications
- High-security, 5-pin tumbler cylinder for superior pick resistance
- Concealed mounting and rugged steel case deter vandalism
- Each model fits both left handed and right handed doors
- Appropriate for lockers with multiple users who are assigned access for short time periods
- Two keys provided for each lock

MASTER LOCK MODEL #	DESCRIPTION
1710	High Security Cylinder and Manual Locking Deadbolt
1714	High Security Cylinder and Automatic Locking Springbolt
KEYING OPTIONS:	KA-Keyed Alike, MK-Master Keyed, GK-Group Keyed



1710



1714



ADA Compliant options available.

PORTABLES

PORTABLE LOCKER LOCKS

Combination Security

- World's best-selling combination lock
 - Reinforced stainless-steel outer case
 - Hardened steel shackle for cut and saw resistance
 - BlockGuard® Anti-Shim Technology deters shimming
 - Available in numerical or letter combinations
- High-security combination lock
 - Double armored stainless-steel case
 - Dual-ball locking and boron-alloy shackle for superior pull, pry, rap and cut resistance
- 1525, 1585 and 2010 have key control override for supervisory access (key ordered separately)



MASTER LOCK MODEL #	DESCRIPTION	VERTICAL SHACKLE CLEARANCE (B)
1500, 1573	1-7/8in (48mm) w. Stainless Steel Body. Shackle Dim.: A: 9/32in (7mm) C: 13/16in (21mm)	3/4in (19mm)
1502, 1572	1-7/8in (48mm) w. Stainless Steel Body. Shackle Dim.: A: 9/32in (7mm) C: 13/16in (21mm) Control Chart Included.	3/4in (19mm)
1525, 1585	1-7/8in (48mm) w. Stainless Steel Body. Shackle Dim.: A: 9/32in (7mm) C: 13/16in (21mm) Control Chart Included.	3/4in (19mm)
2001	2-3/16in (55mm) w. High Security. Shackle Dim.: A: 5/16in (8mm) C: 15/16in (24mm)	1in (25mm)
2002	2-3/16in (55mm) w. High Security. Shackle Dim.: A: 5/16in (8mm) C: 15/16in (24mm) Control Chart Included.	1in (25mm)
2010	2-3/16in (55mm) w. High Security. Shackle Dim.: A: 5/16in (8mm) C: 15/16in (24mm) Extra Length Shackle, Control Chart Included.	1in (25mm)

CNTLKEY	Control Key for 1525, 1585 and 2010	n/a
----------------	-------------------------------------	-----

SHACKLE OPTIONS:	LF = 1-1/2in (38mm) – Lock Model 1500, 1502, 1525, 1585, 1572, 1573 LH = 2in (51mm) – Lock Model 1500, 1502, 1525, 1585, 1572 S = 1/2in (13mm) – Lock Model 2002, 2010
-------------------------	--

KEYING OPTIONS:	KA-Combination Alike – Lock Model 1500, 1502, 1525, 2002, 2010
------------------------	--

COLOR OPTIONS:	<p>Available in 7 colors. Add desired color suffix: BLU, GRN, ORJ, PRP, RED, GRY, GLD</p>
-----------------------	---

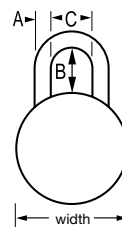

Models 1502, 1525, 1572, 1585, 2002 and 2010 are charted products.

SAFETY LOCKOUT

SAFETY LOCKOUT PRODUCTS

Zenex™ Thermoplastic Safety Padlocks

- Designed by safety directors specifically for OSHA lockout compliance
- Durable, lightweight, non-conductive thermoplastic lock body is easy to carry
- Customize onsite with permanent, write-on “Danger” and “Property of” labels
- High-security, reserved-for-safety cylinder – up to 100,000 key changes
- Compliance with OSHA “one employee, one lock, one key” directive
- Laser engraving service available for an additional charge
- Key retaining – ensures that padlocks are not left unlocked (except model S33)



MASTER LOCK MODEL#	DESCRIPTION	VERTICAL SHACKLE CLEARANCE (B)
406	1-1/2in (38mm) w., 1-3/4in (44mm) Tall Body. Nylon Shackle Dim.: A: 1/4in (6mm) C: 25/32in (20mm)	1-1/2in (38mm)
410	1-1/2in (38mm) w., 1-3/4in (44mm) Tall Body. Shackle Dim.: A: 1/4in (6mm) C: 25/32in (20mm)	1-1/2in (38mm)
411	1-1/2in (38mm) w., 3in (72mm) Tall Body. Shackle Dim.: A: 1/4in (6mm) C: 25/32in (20mm)	1-1/2in (38mm)
0411-5705	Six #411 Laminated Photo I.D. Labels	n/a
S31	1-3/8in (35mm) w., 1-7/8in (48mm) Tall Body. Shackle Dim.: A: 3/16in (5mm) C: 5/8in (16mm)	1-1/2in (38mm)
S33	1-3/8in (35mm) w., 1-7/8in (48mm) Tall Body. Shackle Dim.: A: 3/16in (5mm) C: 5/8in (16mm)	1-1/2in (38mm)
S142	Photo ID labels - 406, 410, S31, S33	n/a
SHACKLE OPTIONS:	LT = 3in (72mm) – Lock Model 410, 411, S31, S33	
COLOR OPTIONS:	Add Desired Color Suffix: RED, ORJ, YLW, GRN, BLU, TEAL, PRP, BLK, WHT (S31 and S33 only)	

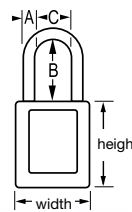

Safety Lockout Hasps

- Lockout by up to six workers at each lockout point
- Keep equipment inoperative while repairs or adjustments are made
- Attach device to energy disconnect switch
- Traditional, scissor-action hasps
 - Available in two jaw diameters to fit all applications
 - Durable heavy-gauge steel construction
 - Insulated with bright vinyl coating
- Snap-on hasp
 - Quick, one-handed attachment to energy switches and controls
 - Aluminum and stainless steel construction
 - Write-on, erase-off labels included for worker identification

MASTER LOCK MODEL#	DESCRIPTION
420	1in (25mm) Inside Diameter, Scissor Hasp
421	1-1/2in (38mm) Inside Diameter, Scissor Hasp
427	1-3/8in (35mm) Inside Diameter, Snap-on Hasp



SAFETY LOCKOUT

Laminated Steel Safety Padlocks

- Reinforced laminated steel construction
- Ideal when locks may be subjected to physical abuse
- Six bumper colors for segmentation by department, etc.
- 1,400 key changes available

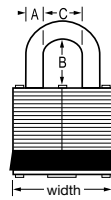

MASTER LOCK MODEL#	DESCRIPTION	VERTICAL SHACKLE CLEARANCE (B)
3	1-9/16in (40mm) w. Body. Shackle; Dim.: A: 9/32in (7mm) C: 5/8in (16mm)	3/4in (19mm)
SHACKLE OPTIONS:	LF = 1-1/2in (38mm); LH = 2in (51mm)	
COLOR OPTIONS:	Add Desired Color Suffix: RED, YLW, BLU, WHT, GRN, BLK	



3

Key Charting Services Available on All Safety Padlock Models

Large users of padlocks may wish to track key codes used in their facility to ensure no key is duplicated. See page 5 for details.

Other Master Lock Safety Lockout Products



S856



480 – 485



491B/493B



S3068

FLEXIBLE SECURITY

FLEXIBLE SECURITY PRODUCTS

Python™ Adjustable Locking Cable

- Patented cinch-locking mechanism holds the cable tight for infinite locking positions
- Weather-tough aluminum-alloy body, cylinder shutter and vinyl-coated cable resist rust and operate in extreme conditions
- Keyed alike convenience with the removable, rekeyable cylinder — key to other Python™ locking cables, Master Lock padlocks or systems with the W1 cylinder
- Increased pick resistance with the patented, modified wafer cylinder
- Cut-resistant, 3/8in (10mm) 100% steel, braided cable
- Interchangeable cables in 4ft (1.2m) to 30ft (9.1m) for application flexibility
- Order any cable length from 2ft to 30ft in 1-foot increments



MASTER LOCK MODEL #	DESCRIPTION
8418	Python™ Adjustable Locking Cable
8413CBLN	Length of Cable (N= 2 feet through 30 feet, increments of 1 foot) Ex. CBL2 - CBL30
KEYING OPTIONS:	KD-Keyed Different and KA-Keyed Alike

Cables, Cable Locks & Chains

- Keep trailers, generators, power tools and ladders securely locked
- All cables feature vinyl-coated braided-steel wires for strength with flexibility
- High-security chain with nylon sleeves protects high-value property

MASTER LOCK MODEL #	DESCRIPTION
Cable Locks	
8119DPF	3/8in (10mm) Diameter, 5ft (1.5m) Long Resettable Combination Cable Lock
8154DPF	3/8in (10mm) Diameter, 6ft (1.8m) Long Integrated Keyed Cable Lock
Braided Security Cables	
72DPF	3/8in (10mm) Diameter, 15ft (4.6m) Long Braided Steel Cable w/Loops
78DPF	3/8in (10mm) Diameter, 6ft (1.8m) Long Braided Steel Cable w/Loops
85DPF	3/8in (10mm) Diameter, 4ft (1.2m) Long Braided Steel Cable w/Loops
Chains	
8291DPS	3/8in (10mm) Diameter, 3ft (91cm) Long Hardened Steel Chain



8413CBLN



8291DPS



8154DPF



8119DPF



72DPF
78DPF
85DPF

U-Locks

- Provide maximum protection against prying, cutting and sawing
- Double locking shackles for maximum pry resistance
- 7-pin tumbler for extreme pick resistance

MASTER LOCK MODEL #	DESCRIPTION
8118DPF	3-11/16in (9cm) w. Vinyl-Coated U-Lock; Works Great With Looped Cables
8174DLWPF	8-1/4in (21cm) w. Vinyl-Coated U-Lock



8118DPF



8174DLWPF

HASPS

Commercial-Grade

- Solid steel body resists cutting, hammering and prying
- Hardened alloy locking eye withstands bolt cutters
- Hardened hinge pins

Standard Security

- Ribbed steel body with rolled edges protects against prying
- Tamper-proof hinge protects against forcible attacks
- Hardened steel locking eye resists cutting

MASTER LOCK MODEL #	DESCRIPTION	ACCEPTS SHACKLE DIA. UP TO:
730	7-1/4in (18cm) Straight Bar	7/16in (11mm)
731	90° Angle Bracket, Hasp Length: 5-3/16in (13cm)	
732	90° Angle Bar, Hasp Length: 4-3/4in (12cm)	
720DPF	6-1/4in (16cm) Single-Hinge	
722DPF	7-3/4in (20cm) Double-Hinge	
770	9in (23mm) w. x 4-1/2in (11.4cm) High Solid Steel Hasp. Use With 6270 and 6271 Locks	n/a

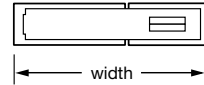

730

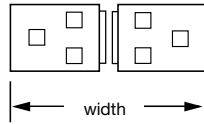

731

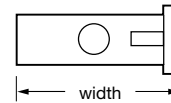

732

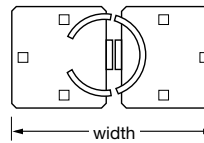

770

See page 9 for 6271 hidden shackle padlock used with 770 hasp.

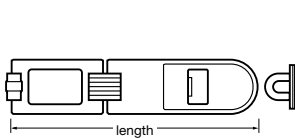

720DPF



722DPF



FLEET SECURITY

FLEET SECURITY PRODUCTS

- Prevent theft and deter break-ins
- Steering wheel lock (no. 252) adjusts to fit all wheel types
- Protect unattended trailers with (no. 377) universal coupler lock – one-size-fits-all design securely encloses coupler socket



MASTER LOCK MODEL #	DESCRIPTION
Steering Wheel Locks	
252DAT	Advanced Security Steering Wheel Lock; Quad Hook
Coupler Locks	
377DAT	Universal Coupler Lock
2847DAT	Adjustable Coupler Latch Lock; 6 locking positions from 9/16in (14mm) to 2-3/4in (56 mm)
37D	1-9/16in (40mm) Armored Coupler/Trigger Lock
605DAT	2in (51mm) Solid Brass Coupler/Trigger Lock
1471DAT	Coupler Latch Lock; 9/32in (7mm) Diameter x 3-1/2in (85mm) Long Shackle; Fits Surge-Brake and UFP Brand Coupler Latches
1475DAT	Coupler Latch Lock; 9/32in (7mm) Diameter x 7/8in (22mm) Long Shackle; Fits Surge-Brake and UFP Brand Coupler Latches
2999DAT	5/8in Chrome Plated Swivel Head, King Pin Coupler Lock
Receiver Locks & Pins	
2866DAT	Receiver Lock; Fits both 1/2in (13mm) and 5/8in (16mm) Receiver Holes; Class I/II for 1/2in Pin and Class III/IV for 5/8in Pin
2848DAT	Receiver and Latch Lock; Stainless Steel Nos. 2847DAT and 2866DAT
1479DAT	Receiver Lock; 5/8in (16mm) Diameter x 2-1/2in (63mm) Long Shackle
1480DAT	Stainless Steel Receiver Lock; Removable Stainless Steel Shackle Sleeve; Fits Both 5/8in (16mm) and 1/2in (13mm) Receiver Holes
370DAT	Class II 1/2in (13mm) Diameter Hitch Pin and Clip
371DAT	Class III/IV 5/8in (16mm) Diameter Hitch Pin and Clip
Semi-Trailer Lock	
387	Keyed Different; High Security King Pin Lock
387KA	Keyed Alike; High Security King Pin Lock
Spare Tire & Lug Nut Locks	
613DAT	6ft (1.8m) Self-Coiling Steel Cable & No. 311 Weather Tough Steel Lock
614DAT	6ft (1.8m) Self-Coiling Steel Cable & No. 141 Covered Brass Padlock
262DAT	Spare Tire Lock, Lug Nut Style



37D



387



377DAT



605DAT



2847DAT

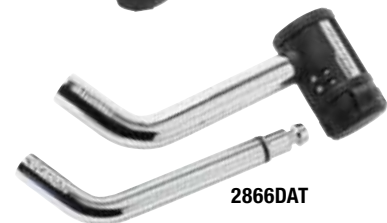

2866DAT



613DAT



370DAT



262DAT



252DAT

2999DAT

KEY SECURITY AND SPECIALTY

KEY SECURITY AND SPECIALTY PRODUCTS

Key Security

Portable key storage products provide additional peace of mind with secured storage of highly valuable items. Portable key storage locks feature a set-your-own combination and a large internal cavity to prevent jamming. Both over-the-door-knob and wall-mount options are available to fit any need and application. Portable mini key safes feature a cable lanyard for the option to attach to a fixed object.

MASTER LOCK MODEL #	DESCRIPTION
5400D	3-1/4in (83mm) wide; portable set-your-own combination lock
5401D	3-1/4in (83mm) wide; wall-mounted set-your-own combination lock
5420D	2-7/8in (72mm) wide; portable universal lock box
5422D	Push button portable lock box
5423D	Push button wall mount lock box
5424D	Combination light up dial portable lock box
5425D	Combination light up dial wall mount lock box



Specialty Locks

Single post and discus-style locks are ideal for valves, vending machines and self-storage facilities

MASTER LOCK MODEL #	DESCRIPTION
40DPF	Keyed Different
443LE	Keyed Different 7/8in (22mm) Post
KEYING OPTIONS:	KD-Keyed Different (default option), KA-Keyed Alike

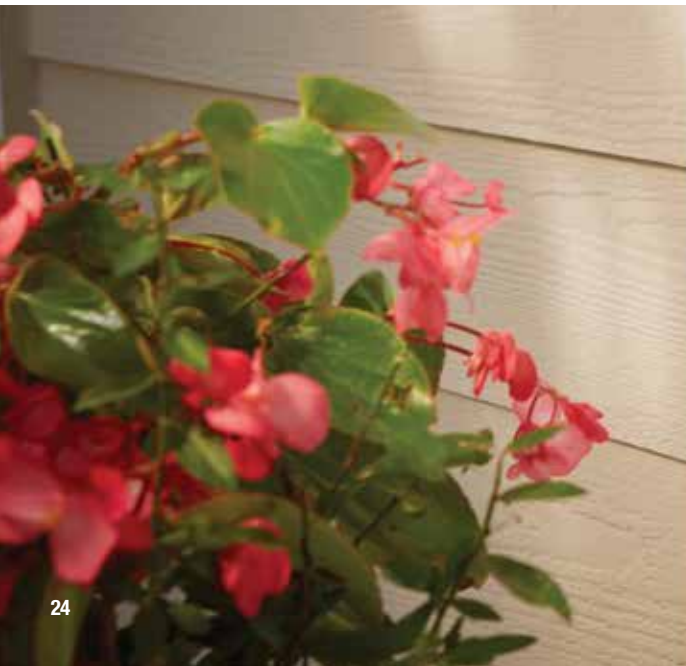



Locker and Storage Security Products Catalog

Schools • Business & Industry • Health Clubs • ADA



Locker Lock Security Products Catalog

Pg.	Section
3	Great Technologies
4	Lock Selector
5	All About ADA
Built-In Locks	
6 - 7	3685 Electronic Lock
8 - 9	Multi-User Mechanical Lock
10 - 11	1652 Combination Series
12	1654 Combination Series
13	1630 Combination Series
14	1670 Combination Series
15	1690 Combination Series
16	1710 & 1714 Keyed Series
17	1790 Keyed Series
Portable Locks	
18	1502 & 1525 Portable Series
19	Letter Lock™ 1572 & 1585 Portable Series
20	2002 & 2010 Portable Series
ADA Compliant Locks	
21	Built-In Combination Locks
22	Built-In Keyed Locks
23	3681 Electronic Built-In Lock
ADA Inspired Locks	
5, 18	1525EZRC Combination Lock
5, 23	PushKey™ Portable Lock

Recognized as the authentic, enduring name in padlocks and security products, Master Lock® has set the standard for quality and selection for more than 90 years.

Building on this tradition, Master Lock has greatly expanded its commercial product line, especially for safety lockout and high security applications. Today, there are many good reasons to specify Master Lock padlocks for your applications:

The broadest line: Master Lock offers a full line of products for virtually any commercial, institutional, industrial security and safety application.

Superior product quality: All Master Lock products are built with the unmatched strength and durability that you've come to know and trust. Each lock is individually tested to ensure years of trouble-free operation, dependable performance and peace of mind.

Controlled key security: Allows you to establish a safe, secure and convenient locking system. Master Lock stands alone among padlock suppliers in (a) designing security into the padlock's cylinder and operating key, and (b) providing key and installation database security management services as needed to assure the utmost in system integrity.

Unmatched sales support: Service and consultation is available to you both through our broad network of distributors as well as Master Lock's experienced sales organization.

Personal service: Our inside customer service group stands ready to provide assistance to your call.

Prompt delivery to you: Direct from our stocking distributors, or alternatively, through one of Master Lock's ISO-9001 certified facilities; our stock product distribution center or special product 'Make-to-Order' factory.

You can trust Master Lock for the products, security, support and service you need.

Button-Less Combination Change

No Buttons to Push. No Doors to Open. No Accidental Combination Changes.

The redesigned 1652 Series now features a patent-pending button-less combination change process that allows you to switch to the next combination without having to open the locker door! Sporting an all-new sleek dial design, this lock saves on overall maintenance time and prevents accidental combination change by overstuffed lockers.



BlockGuard® Anti-Shim Padlock Technology

Advances Padlock Security to the Next Level.

Leading the market with innovative security solutions, Master Lock® offers the patented BlockGuard® Anti-Shim Technology – the very best in shim deterrence for combination padlocks.

These enhanced combination locks deter shimming, a method of violating a lock by inserting a specially designed shim tool into its latch mechanism. BlockGuard® has unique flat latch technology that actually blocks typical shimming tools from opening the lock – deterring break-ins.

Master Lock exclusive BlockGuard® Anti-Shim Technology (U.S. Patent No. 8,099,985) is now available on Models 1502, 1525, 1572, 1585 and 2076.



Wrap Around Latch™ Technology

The Best Lock for Single Point Latch Lockers!

The patented model 1690, 1695MKADA, and 1790 built-in locks use the same technology as an automotive door lock system, utilizing slam shut operation combined with a rotating latch that wraps around the latch plate. Designed for Single Point Latch Lockers, these locks provide the most robust design and requires the least adjustment for proper operation (U.S. Patent No. 7,984,630).



Latch Wraps Around The Latch Plate

Less Maintenance, More Security, Easy-To-Use

EXTREMELY PRY RESISTANT



The lock latch can not be easily separated from the latch plate through horizontal or vertical prying.

Latch hits side stop and bottom before disengaging: Can not come off latch plate!

EXTREMELY SHIM RESISTANT



Even in the case of ventilated lockers the 1690/1790 hold strong as the Wrap Around Latch™ prevents the use of shims and similar techniques for opening the door.

Dead bolt latch automatically locks in position once the locker door is shut, preventing defeating the lock through attempts to move or shim the lock.











INCREASED HORIZONTAL TOLERANCE



A wider operating range reduces the need for call backs or future maintenance adjustments. This saves your facility time and money.

The 1690 design offers a much wider operating range.

Lock Selector

	Locker Application	Supervisory Access	Resistance to Vandalism	Levels of Security	Multiple User Access	Ease of Use
Electronic Built-In Lock						
Horizontal Latch (DB)  3685 Pg. 6	All - Single Point Latch Lockers	BEST Backup Master Code *Optional Admin/Key	BETTER Concealed Mounting	BEST Automatic Deadbolt Locking	BEST Designed for Multi-user or Single-user	BEST Electronic Keypad and Display Screen
Multi-User Built-In Mechanical Lock						
Horizontal Latch (DB)  3670 Pg. 8	All - Single Point Latch Lockers	BEST Master Keyed Standard	BETTER Concealed Mounting	BETTER Manual Deadbolt Locking	BEST Designed for Multi-user	BETTER Manual Locking
Horizontal Latch  3630/3631 Pg. 8	Lift Handle					
Built-In Combination NOTE: All combination locks are 3 number combinations						
Vertical Latch  1630 Pg. 13 1636MKADA Pg. 21	Lift Handle	BEST Master Keyed Standard	BETTER Concealed Mounting	BEST Automatic Deadbolt	BETTER Multi Year Use with 5 Touch-of-a-Button Combination Changes Built in	BEST Slam Shut
Wrap Around Latch™  1690 Pg. 15 1695MKADA Pg. 21	Single Point Wrap Around Latch			BEST Automatic Dead Locking, Wrap Around Latch		
Horizontal Latch  1652 Pg. 10 1654 (SB) Pg. 12 1670 (DB) Pg. 14 1676MKADA (DB) Pg. 21	All - Single Point Horiz. Latch 1670/1676MKADA Single Point Horizontal Latch and Lift Handle			BETTER Spring Bolt and Dead Bolt Models		BEST/BETTER Slam Shut or Manual Lock Option
Built-In Keyed						
Wrap Around Latch™  1790 Pg. 17	Single Point Wrap Around Latch	BETTER Master Keyed Optional	BEST Concealed Mounting, No Exposed Parts	BEST Automatic Deadbolt, Wrap Around Latch	BETTER Manual Key Assignment and Retrieval	BEST Key Operated
Horizontal Latch  1710 (DB) Pg. 16 1714 (SB) Pg. 16	Single Point Horizontal Latch and Lift Handle			BETTER Spring Bolt and Deadbolt Models		
Portable Combination NOTE: All combination locks are 3 number combinations						
General Security  1502/1525 Pg. 18 1572/1585 Pg. 19	Lockers with a Hasp	BETTER Master Keyed Optional	GOOD Hardened Shackle	GOOD Single Lever Locking*	GOOD Single Owner/User	BETTER Dial Operated
High Security  2002/2010 Pg. 20				BEST Dual Ball Locking		
Portable Keyed						
PushKey™  2650 Pg. 23	Lockers with a Hasp	GOOD Four Keys Included	GOOD Hardened Shackle	GOOD Push Key Cylinder Locking	BETTER Manual Key Assignment and Retrieval	BEST Key Operated

(DB) = Deadbolt (SB) = Springbolt

 = Various Colors Available

*BlockGuard® Anti-Shim Technology

ADA Lock Solutions

ADA COMPLIANCE DEFINED



The Master Lock® 3681 Electronic Built-In Lock, 1600 ADA Series and 1700 ADA Series Built-in Locks meet the United States Department of Justice "2010 ADA Standards for Accessible Design". This Standard requires 5% of lockers meet ADA specifications. In addition, these standards state that operable parts, the locks, meet the following requirements:

- Shall be operable with one hand
- Shall not require tight grasping, pinching, or twisting of the wrist to operate
- Shall have a force required to activate of 5 lbf (22.2N) maximum

Master Lock ADA Compliant Mechanical Locker Locks achieve these requirements through the use of a specially designed keyhead and the simple operation of the lock. The large flat keyhead makes the key easy to grip for those with extreme joint pain. For those with clenched fist dexterity, the flat keyhead fits securely between their fingers. The operation of the lock can be achieved by a simple bumping action to the ADA keyhead to both open and close the lock without the need of tight grasping, pinching, or twisting of the wrist.

As needs and requirements vary, please consult the local authority regarding use of any of these locks for a specific application.

3681 ELECTRONIC BUILT-IN LOCK



3681
For single point latch lockers, deadbolt operation

- Bluetooth fob for fast and easy operation
- Each lock comes paired with one fob
- Can also be used as non-ADA single- or multi-user lock

See Page 23 for more information

1600 ADA SERIES BUILT-IN COMBINATION LOCKS WITH STUDENT KEY/ MASTER KEY



Three-Ways-To-Open™ technology lock:

- Student Key for ADA users (opens 1 lock)
- Master Key for supervisors (opens all ADA locks in your system)
- Combination for use like other combo locks in your system (5 combinations built in for reuse year after year)

Two keys with ADA keyheads included; order Master Keys separately
Left hand models available; see chart



1636MKADA
For Multi-Point Latch, Lift Handle Lockers

1656MKADA
For Single Point Horizontal Latch Lockers, Springbolt Operation

1676MKADA
For Single Point or Multi-Point Horizontal Latch Lockers, Deadbolt Operation

1695MKADA
For Single Point Wrap Around Latch™ Lockers

See Page 20 for more information

1700 SERIES BUILT-IN KEY ONLY LOCKS



- Simple and economical solution for lockers for those with special needs
 - Each includes two keys, one with large ADA key head.
- Order Master Keys separately.



1710MKADA
For Single Point or Multi-Point Latch Lockers, Deadbolt Operation

1714MKADA
For Single Point Latch Lockers, Springbolt Horizontal Operation

1790MKADA
For Single Point Wrap Around Latch™ Lockers

See Page 21 for more information



ADA KEYHEAD

1710-43959
Converts provided keys to meet ADA requirements

ADA Compliant Selection Guide

Master Lock Product #	Locker Hinge Orientation	Reduced Physical Abilities	Reduced Cognitive Abilities	Same Function as Model
ADA COMPLIANT BUILT-IN LOCKER LOCKS				
3681	Right or Left Hand	*	*	3685
1636MKADA	Right Hand	*	*	1630
1637MKADA	Left Hand	*	*	1631
1656MKADA	Right Hand	*	*	1652
1651MKADA	Left Hand	*	*	1653
1676MKADA	Right Hand	*	*	1670
1677MKADA	Left Hand	*	*	1671
1695MKADA	Right Hand	*	*	1690
1710MKADA	Right or Left Hand	*	*	1710MK
1714MKADA	Right or Left Hand	*	*	1714MK
1790MKADA	Right Hand	*	*	1790MK

ADA Inspired Selection Guide

Master Lock Product #	Locker Hinge Orientation	Reduced Physical Abilities	Reduced Cognitive Abilities	Same Function as Model
ADA INSPIRED PORTABLE LOCKER LOCKS				
1525EZRC	Right or Left Hand	-	*	1525
2650	Right or Left Hand	*	*	-

ADA INSPIRED DEFINED



Master Lock ADA Inspired locks address special needs beyond those outlined in the "2010 ADA Standards for Accessible Design". These portable locks are designed to be easy to use and assist those with physical or cognitive challenges operate a lock independently. All ADA Inspired locks fit most standard lockers.



1525EZRC
Simple Combos™

- Simple Combos™ – specially selected combinations that use only numbers printed on the dial (no sub-increments) so users can more easily recall and dial their combination
- Supervisory key override matches existing Master Lock portable systems, plus key can also be matched with many built-in combination lock systems
- Colored dials – black, green, purple, red, blue, orange, grey or gold, and customization with your logo or text available



2650
PushKey™

- Easy-to-open and simple-to-use – simply insert the key and pull down on the flared, easy-to-grip body to open (no key turning required)
- Includes four keys, two with large key head covers which makes gripping easy for anyone

Electronic Series **NEW PRODUCT!**

ELECTRONIC BUILT-IN LOCKS

Elevate the Locker Room Experience



3685

Fits a Variety of Locker Styles

Exclusive Features

- High-visibility display clearly shows locker vacancy status
- Supports single- and multi-user modes
- Sensors provide visual & audible jam alerts

Built-In Electronic Advantages

- Long battery life with 1 CR123A lithium battery
- Clear low battery indicator
- Unique Backup Master Code simplifies facility manager access
- Strike plate included

Product Options

- Model 3685
 - Fits both right- & left-handed hinged doors
 - Electronic deadbolt locking
- Model 3681
 - ADA compliant with Bluetooth-enabled fob (included)
 - Use as ADA or standard model (See page 23)
- Model 1566 Administration Key
 - Optional; allows for easy set-up locker checks & forgotten code support



3681



1566

Ideal for Health Clubs, Spas, Collegiate & Recreation Facilities.

Intuitive Display Screen icons

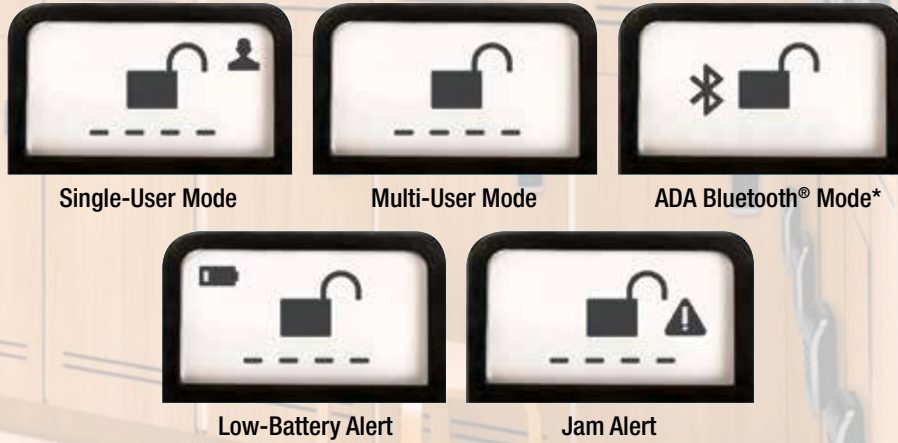

Series Models: 3685, 3681

Fits door thickness 0.03, 0.5 & 0.75in (.79, 12.7 & 19mm)

Dimensions

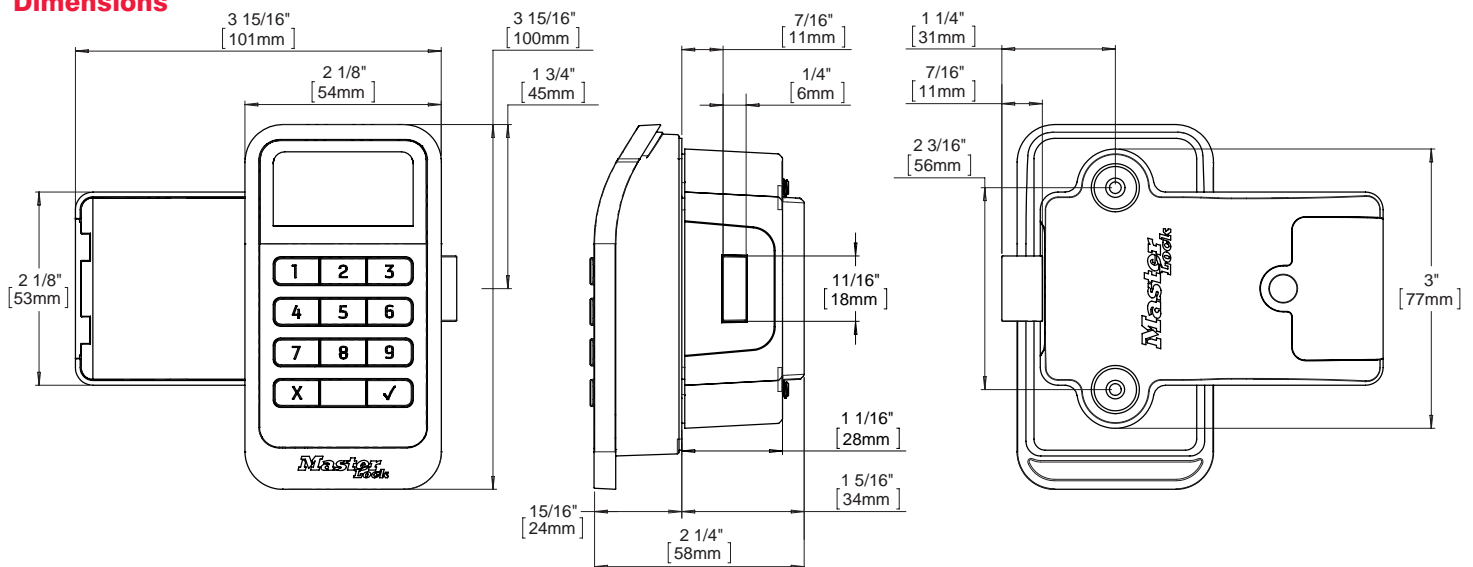

Architectural Specifications: Locks shall be built-in electronic lock with model #3685, featuring an electromechanical deadbolt and reversible for right- or left-hinged doors. Locks shall be supplied with printed control chart of Lock Device IDs & Backup Master Codes.

Multi-User Series

BUILT-IN MECHANICAL LOCKS

Ultimate Convenience

FOR YOU AND YOUR CUSTOMER



Fits a Variety of Locker Styles See Product Options Below

Exclusive Features

- Intuitive, easy-to-use design
- Set-your-own 3-digit combination
- Retains current combination until re-set
- Sleek design with satin finish

Built-In Multi-User Lock Advantages

- Designed for multiple use in a day for high customer turnover facilities
- Eliminates distribution, tracking and management of keys, combination or locks
- Concealed mounting and rugged zinc case
- Standard key control allows quick supervisory access
- End user registration provided to secure and simplify administration

Product Options

- Model 3670
 - for left-handed & right-handed hinged doors
 - for lift handle lockers
 - for single point latch lockers
 - manual deadbolt locking
- Model 3630
 - for right-handed hinged doors
 - for lift handle lockers
 - manual spring locking
- Model 3631
 - for left-handed hinged doors
 - for lift handle lockers
 - manual spring locking
- Extension Kit available for doors with a thickness of 11/16in (17mm) to 3/4in (19mm) #3630-0320



3630



3670

Ideal for Health Clubs, Country Clubs, Universities and Similar Facilities.



How It Works

1. Spin the Dials to Personalized 3-Digit Combination
2. Turn the Knob to the  Icon
3. Scramble the Dials

Series Models: 3670, 3630, 3631 See Product Options for more information

Fits door thickness 0.03 – 0.125in (0.8 – 3.2mm) This lock requires a mounting hole diameter of 1/4in minimum for proper installation and fit.

Dimensions

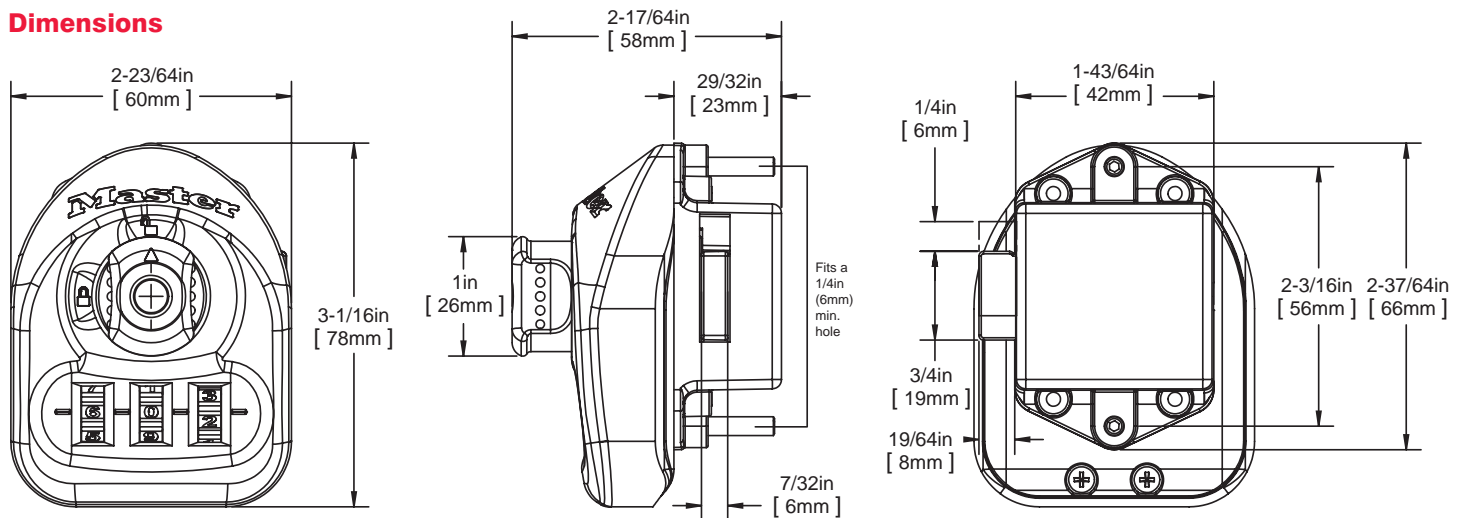

Architectural Specifications: Locks shall be built-in multi-user lock with models #3630, #3631 featuring vertically operating bolt and model #3670 featuring horizontally operating deadbolt. Locks shall have a disc cylinder for supervisory access. Locks shall have resettable combinations with no presets. Model #3630 for doors hinged on the left, model #3632 for doors hinged on the right and model #3670 for doors hinged on the right or left.

1652 Series **NEW BUTTON-LESS DESIGN**

BUILT-IN COMBINATION LOCKS

The Lock You Know...
REINVENTED!



Customize colors
(available with metal dials)

For Single Point Horizontal Latch Lockers

Exclusive Features

- New Button-less combination process – no need to open the locker door, everything is done from the outside with your control key
- Stylish, octagonal dial with larger dial numbers and easy grip for one handed operation
- The longest fully retractable bolt
- Full bolt retraction eliminates lockouts
- Springbolt action for convenient, automatic locking

Built-in Combination Lock Advantages

- Concealed mounting and rugged steel case
- Secure, three number combination is easy to dial
- Longer, useful life with five different combinations – easily changed to maintain security for new students or employees

- Standard key control allows quick supervisory access
- End user registration and control charts provided to secure and simplify administration

Product Options

- Customize with color – metal dials available in red, blue, green, purple and black (featuring non-slip grip dials)
- Model 1653 is available for left-hand hinged doors
- Extension set available for doors with a thickness of 11/16in (17mm) to 3/4in (19mm) #1654-0320
- Metal dial available to deter vandalism (metal dials feature non-slip grip dials) #s 1652MD, 1653MD
- ADA Compliant lock models available #s 1656MKADA for right-hand hinged doors, 1651MKADA for left-hand hinged doors (See page 21)

The 1652 Series offers the longest fully retractable bolt with the convenience of an automatic locking spring bolt.



New Combination Change Process Reduces Maintenance Time

- No Buttons to Push!
- No Doors to Open!
- No Accidental Combination Changes!

Easy Combination Changing

- Eliminate the hassle of opening every locker door to change combinations

Series Models: 1652, 1653, 1651MKADA, 1656MKADA See Product Options for more information

Dimensions

Fits door thickness 0.03 – 0.125in (0.8 – 3.2mm)

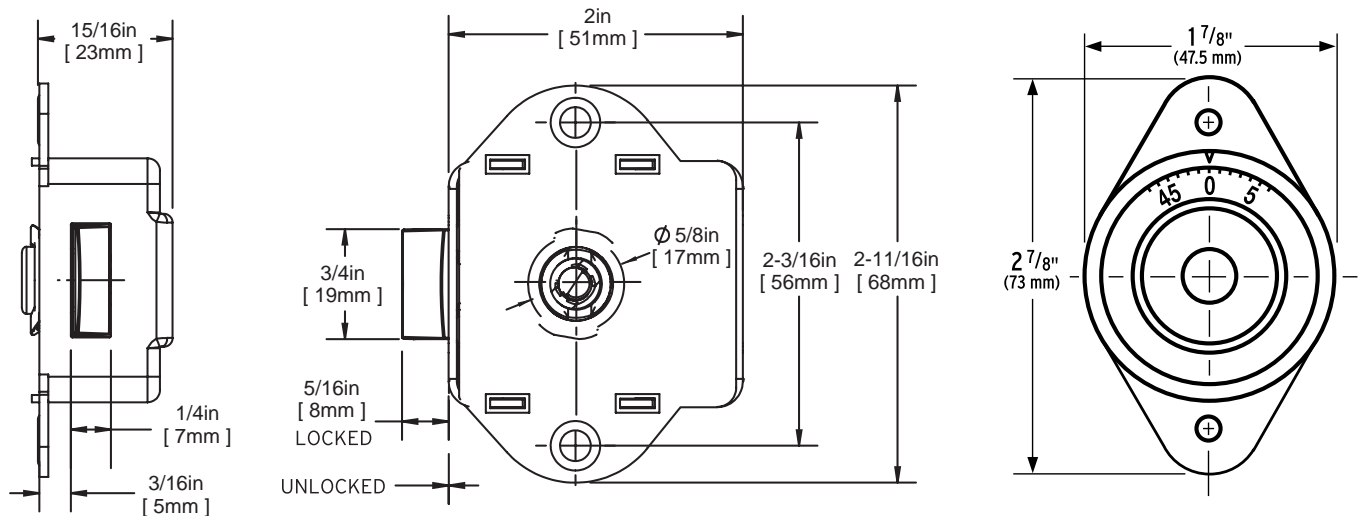

Architectural Specifications: Locks shall be built-in combination lock with horizontally operating spring bolt. Locks shall have textured, lipped dial design for easy-grip-and-pull operation. Locks shall have 5-pin tumbler cylinder for supervisory access. Locks shall have five (5) preset combinations. Locks shall have random combination change pattern; no sequentially adjacent locks shall have the same combination change pattern. Locks shall be supplied with printed Control Chart of serial numbers and combinations and text file on disc. Master Lock #1652 for lockers hinged on right. Master Lock #1653 for lockers hinged on left. For optional metal, easy-grip-and-pull dial with non-slip finish specify Master Lock #1652MD or #1653MD.

1654 Series

BUILT-IN COMBINATION LOCKS



For Horizontal Latch Box Lockers

The 1654 Series is the most popular lock for multiple-tier and box lockers with pull or friction latch handles; it offers convenient automatic locking.

Series Models: 1654, 1655

See Product Options for more information

Exclusive Features

- Stylish, octagonal dial with larger dial numbers and easy grip for one handed operation
- Horizontal travel, standard length locking bolt retracts flush with lock body
- Springbolt action for convenient, automatic locking
- Ideal for box or multiple-tiered lockers

- Standard key control allows quick supervisory access
- End user registration and control charts provided to secure and simplify administration



Locked

Unlocked

Product Options

- Customize with color – metal dials available in red, blue, green, purple and black (featuring non-slip grip dials)
- Model 1655 is available for left-handed doors
- Extension set available for doors with a thickness of 11/16in (17mm) to 3/4in (19mm) #1654-0320
- Metal dial available to deter vandalism (metal dials feature non-slip grip dials) #s 1654MD, 1655MD

Built-in Combination Lock Advantages

- Concealed mounting and rugged steel case
- Secure, three number combination is easy to dial
- Longer, useful life with five different combinations – easily changed to maintain security for new students or employees



Customize colors (available with metal dials)

Dimensions

Fits door thickness 0.03 – 0.125in (0.8 – 3.2mm)

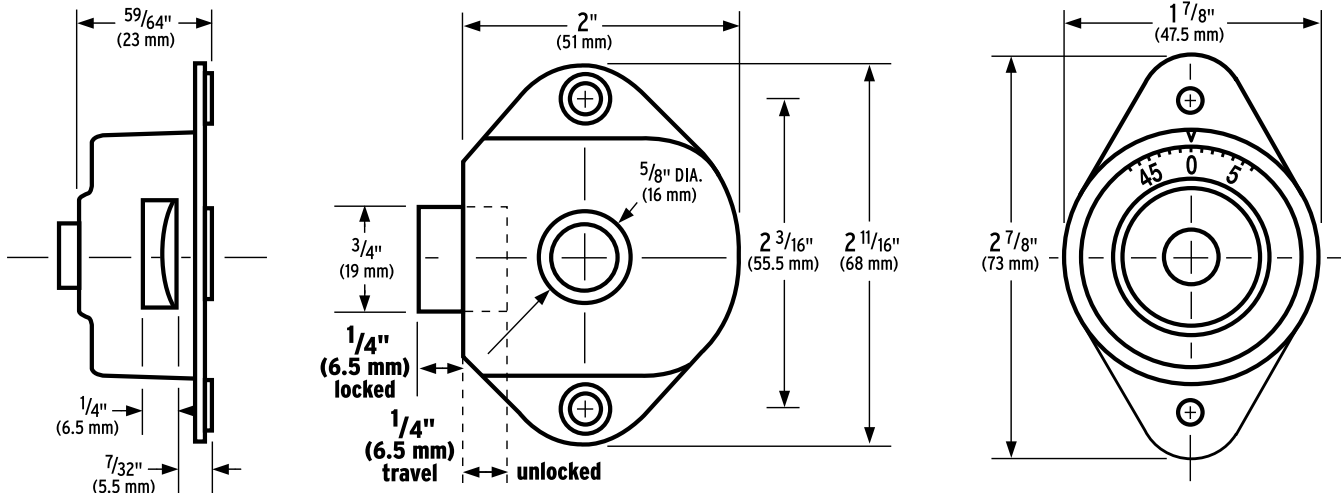

Architectural Specifications: Locks shall be built-in combination lock with horizontally operating spring bolt. Locks shall have textured, lipped dial design for easy-grip-and-pull operation. Locks shall have 5-pin tumbler cylinder for supervisory access. Locks shall have five (5) preset combinations. Locks shall have random combination change pattern; no sequentially adjacent locks shall have the same combination change pattern. Locks shall be supplied with printed Control Chart of serial numbers and combinations and text file on disc. Master Lock #1654 for lockers hinged on right. Master Lock #1655 for lockers hinged on left. For optional metal, easy-grip-and-pull dial with non-slip finish specify Master Lock #1654MD or #1655MD.

1630 Series

BUILT-IN COMBINATION LOCKS



For Lift Handle Lockers

The 1630 Series is the most popular built-in lock for lockers with gravity lift handles; it offers convenient automatic locking

Series Models: 1630, 1631, 1636MKADA, 1637MKADA

See Product Options for more information

Exclusive Features

- Vertical travel locking bolt engages lift handle locker mechanism
- Convenient, automatic locking
- Fits all lift handle lockers

Built-in Combination Lock Advantages

- Concealed mounting and rugged steel case
- Secure, three number combination is easy to dial
- Longer, useful life with five different combinations – easily changed to maintain security for new students or employees
- Standard key control allows quick supervisory access
- End user registration and control charts provided to secure and simplify administration

Product Options

- Customize with color – metal dials available in red, blue, green, purple and black
- Model 1631 is available for left-hand hinged doors
- Metal dial available to deter vandalism #s 1630MD, 1631MD
- ADA Compliant lock models available #s 1636MKADA for right-hand hinged doors, 1637MKADA for left-hand hinged doors (See page 21)



Locked

Unlocked



Customize colors

Dimensions

Fits door thickness 0.03 – 0.125in (0.8 – 3.2mm)

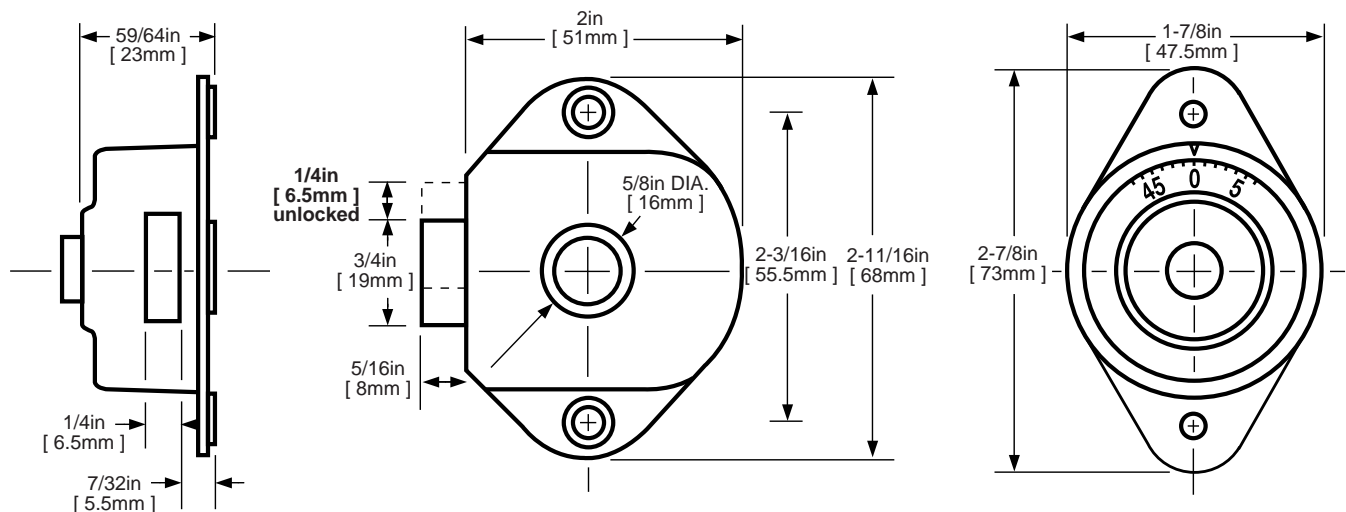

Architectural Specifications: Locks shall be built-in combination lock with vertically operating bolt. Locks shall automatically relock on door closure. Locks shall have 5 pin tumbler cylinder for supervisory access. Locks shall have five (5) preset combinations. Locks shall have random combination change pattern; no sequentially adjacent locks shall have the same combination change pattern. Locks shall be supplied with printed Control Chart of serial numbers and combinations and text file on disc. Master Lock #1630 for lockers hinged on right. Master Lock #1631 for lockers hinged on left. For optional one-piece metal dial with non-slip finish specify Master Lock #1630MD or #1631MD.

1670 Series

BUILT-IN COMBINATION DEADBOLT LOCKS



For Lift Handle, Single Point Horizontal Latch and Box Lockers

The 1670 Series is the highest security built-in combination deadbolt lock for lift handle, turn handle and single point latch/box horizontal latch lockers.

Series Models: 1670, 1671, 1676MKADA, 1677MKADA

See Product Options for more information

Exclusive Features

- Horizontal bolt travel provides maximum engagement to latch mechanism
- Deadbolt locking is ideal for open mesh and ventilated lockers with access to back of lock
- Manual action requires the dial to be turned to relock door
- Fits all locker styles (with the exception of the Wrap Around Latch™ designed lockers)

- Standard key control allows quick supervisory access
- End user registration and control charts provided to secure and simplify administration



Locked

Unlocked



Customize colors

Product Options

- Customize with color – metal dials available in red, blue, green, purple and black
- Model 1671 is available for left-hand hinged doors
- Extension set available for doors with a thickness of 11/16in (17mm) to 3/4in (19mm) # 1654-0320
- Metal dial available to deter vandalism (metal dials feature non-slip grip dials) #s 1670MD, 1671MD
- ADA Compliant lock model available #s 1676MKADA for right-hand hinged doors, 1677MKADA for left-hand hinged doors (See page 21)

Built-in Combination Lock Advantages

- Concealed mounting and rugged steel case
- Secure, three number combination is easy to dial
- Longer, useful life with five different combinations – easily changed to maintain security for new students or employees

Dimensions

Fits door thickness 0.03 – 0.125in (0.8 – 3.2mm)

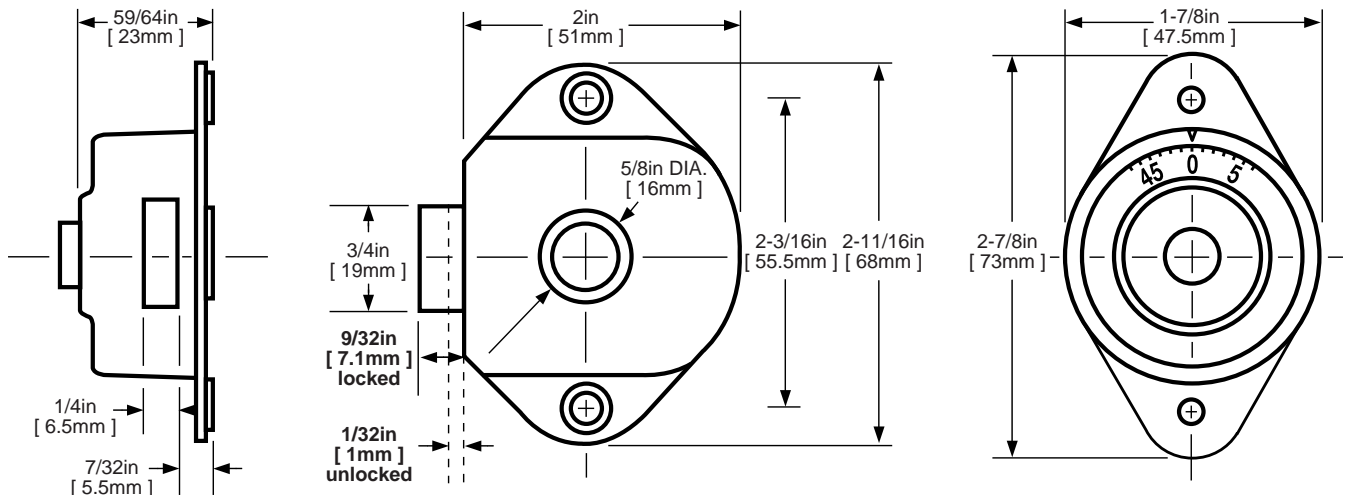

Architectural Specifications: Locks shall be built-in combination lock with horizontally operating deadbolt. Locks shall manually unlock and re-lock. Locks shall have 5 pin tumbler cylinder for supervisory access. Locks shall have five (5) preset combinations. Locks shall have random combination change pattern; no sequentially adjacent locks shall have the same combination change pattern. Locks shall be supplied with printed Control Chart of serial numbers and combinations and text file on disc. Master Lock #1670 for lockers hinged on right. Master Lock #1671 for lockers hinged on left. For optional one-piece metal dial with non-slip finish specify Master Lock #1670MD or #1671MD.

1690 Series

BUILT-IN COMBINATION LOCKS



For Single Point Wrap Around Latch™ Lockers

Enhanced security built-in combination lock – the best lock for single point latch lockers!

Series Models: 1690, 1695MKADA

See Product Options for more information

Exclusive Features

- Designed to tolerate locker misalignment making installation easier and less likely to need adjustment over the life of the lock
- Latch wraps around a latch plate offering the best and most secure single point latch engagement
- Convenient, automatic slam-shut locking combined with automatic and secure dead bolt locking
- Patented Wrap Around Latch™ technology (U.S. Patent No. 7,984,630)

- Longer, useful life with five different combinations – easily changed to maintain security for new students or employees
- Standard key control allows quick supervisory access
- End user registration and control charts provided to secure and simplify administration

Product Options

- Customize with color – metal dials available in red, blue, green, purple and black (featuring non-slip grip dials)
- Metal dial available to deter vandalism #1690MD
- Extension set available for doors with a thickness of 11/16in (17mm) to 3/4in (19mm) #1654-0320
- ADA Compliant lock model available #1695MKADA (See page 21)

Built-in Combination Lock Advantages

- Concealed mounting and rugged steel case
- Automatic combination reset once door is shut
- Secure, three number combination is easy to dial

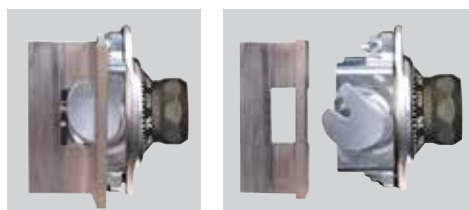

Locked

Unlocked



Customize colors (available with metal dials)

Dimensions

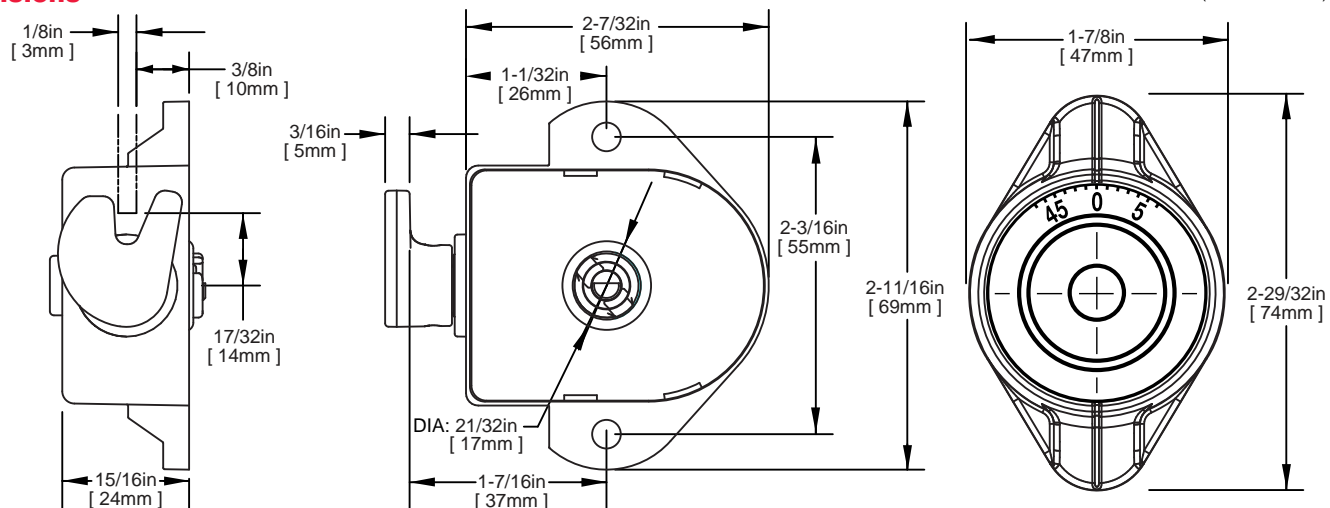

Architectural Specifications: Locks shall be a built-in combination lock with a rotational operating deadbolt latch that locks by wrapping around a stationary latch plate or post. Once open, re-locking shall operate by simply shutting the door, with no further operator action to lock the lock. Once locked, the latch shall not be moveable until the lock is properly opened. Locks shall have textured lipped dial design for easy-grip-and -pull operation. Locks shall have a 5 pin tumbler cylinder for supervisory key access. Locks shall have five (5) preset combinations. Locks shall have a random combination change pattern; no sequentially adjacent locks shall have the same combination change pattern. Locks shall be supplied with both a printed Control Chart and disc, containing the serial numbers and combinations. Master Lock #1690 for lockers hinged on right. For optional one-piece metal dial with non-slip finish specify Master Lock #1690MD.

1710 & 1714 Series

BUILT-IN KEYED LOCKS



For Lift Handle, Single Point Horizontal Latch and Box Lockers

Perfect for horizontal and single point lockers with multiple users who are assigned access for short time periods.

Series Models: 1710, 1710ADA, 1710MKADA, 1714, 1714ADA, 1714MKADA

See Product Options for more information

Exclusive Features

- Model 1710
 - Manual deadbolt locking for highest security
 - Ideal for ventilated and open mesh lockers
- Model 1714
 - Automatic locking springbolt for slam shut convenience
 - Ideal for box lockers

Built-in Combination Lock Advantages

- Appropriate for lockers with multiple users who are assigned access for short time periods (ie. At health clubs, gyms and pools)
- High security, 5-pin tumbler cylinder for superior pick resistance
- Concealed mounting and rugged steel case
- Two keys provided for each lock
- Each model fits both left-hand and right-hand hinged doors

Product Options

- Keyed alike, master keyed and group keyed options available to provide complete flexibility to match a facility's requirements
- ADA Compliant lock model available
#s 1710ADA, 1710MKADA, 1714ADA, 1714MKADA (See page 22)



Locked

Unlocked

Dimensions

Fits door thickness 0.02 – 0.188in (0.5 – 4.7 mm)

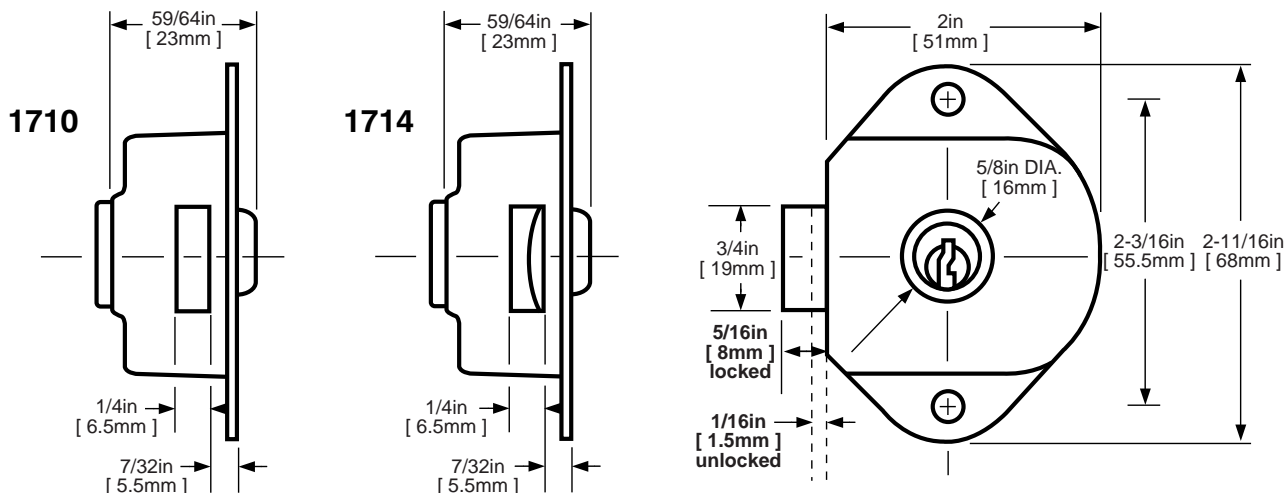

Architectural Specifications: Locks shall be key-operated with 5 pin tumbler cylinder with individual, group, or master keying [specifier must choose keying option]. Two(2) keys per lock and mounting hardware shall be included with each lock. Specify Master Lock #1710 for deadbolt operation or Master Lock #1714 for spring bolt operation. For optional master keying, specify Master Lock # 1710MK or Master Lock # 1714MK. For optional group keying, specify Master Lock #1710GK or Master Lock #1714GK.

1790 Series

BUILT-IN KEYED LOCKS



For Single Point Wrap Around Latch™ Lockers

Enhanced security built-in keyed lock – the best lock for single point latch lockers!

Series Models: 1790, 1790ADA, 1790MKADA

See Product Options for more information

Exclusive Features

- Designed to tolerate locker misalignment making installation easier and less likely to need adjustment over the life of the lock
- Latch wraps around a latch plate offering the best and most secure single point latch engagement
- Convenient, automatic slam-shut locking combined with automatic and secure dead bolt locking

- High security, 5-pin tumbler cylinder for superior pick resistance
- Concealed mounting and rugged steel case
- Two keys provided for each lock

Product Options

- Keyed alike, master keyed and group keyed options available to provide complete flexibility to match a facility's requirements
- ADA Compliant lock model available #s 1790ADA, 1790MKADA (See page 22)



Locked



Unlocked

Built-in Keyed Lock Advantages

- Appropriate for lockers with multiple users who are assigned access for short time periods (ie. at health clubs, gyms and pools)

Dimensions

Fits door thickness 0.02 – 0.188in (0.5 – 4.7 mm)

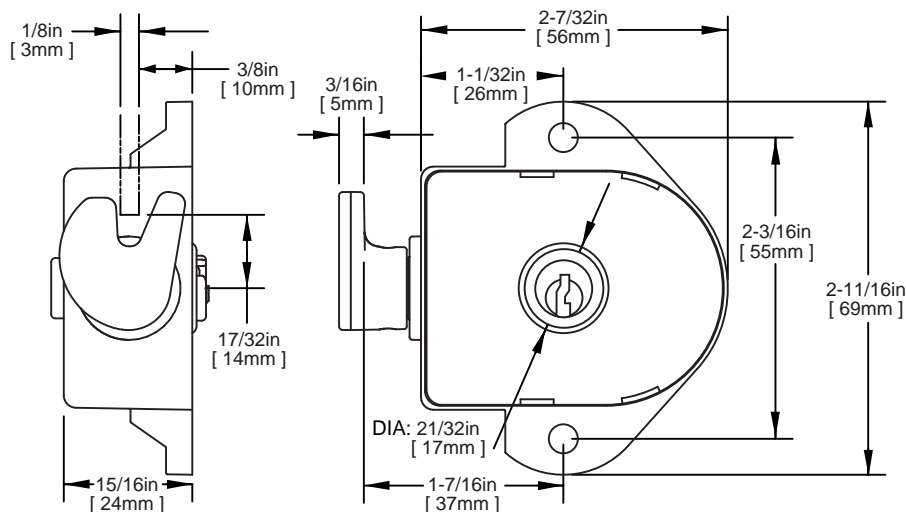

Architectural Specifications: Locks shall be a built-in keyed lock with a rotational operating deadbolt latch that locks by wrapping around a stationary latch plate or post. Once locked, the latch shall not be moveable until the lock is properly opened. Locks shall be key-operated with 5 pin tumbler cylinder with individual, group, or master keying [specifier must choose keying option]. Two(2) keys per lock and mounting hardware shall be included with each lock. For optional master keying, specify Master Lock #1790MK. For optional group keying, specify Master Lock #1790GK.

1502 & 1525 Series

PORTABLE COMBINATION LOCKS

General Security Combination Padlocks

The world's most popular combination padlocks due to their durability, reliability, convenience and affordability.

Series Models: 1502, 1525

Model 1525 has additional feature of key control for supervisory access
See Product Options for more information

Exclusive Features

- BlockGuard® Anti-Shim Technology - blocks typical shimming tools from opening the lock – deterring break-ins (U.S. Patent No. 8,099,985)
- Hardened steel shackle resists cutting and prying
- Double-reinforced stainless steel case with cold-rolled steel construction shields locking mechanism from physical attack
- 40 number, three-digit dialing provides thousands of possible combinations
- Dial automatically locks under shackle tension to prevent “feeling out” the combination
- Combination automatically scrambles when lock is closed to prevent accidental opening
- Fits lockers with a padlock eye of at least 5/16in (8mm) diameter



Product Options and Accessories

- Longer shackle lengths available for special applications
- 1525EZRC Simple Combos™ Only the numbers printed on the dial for your lock combination. **ADA Inspired** Easy-to-Dial, Easy-to-Remember (See page 5)
- Custom logo or text
- Colored dials
- Bumpers – Reduce locker wear/less noise: black (1500-0620), red (1504-0620) or blue (1506-0620)
- Combinations in pairs or alike
 - Order 2 or more locks with the same combination. Allows student using multiple locks to use same combination for each lock
- Special back case printing
 - Your custom text engraved on lock backs
- Blank dialing instruction tags (1500-0590)
 - For administrative redistribution of locks

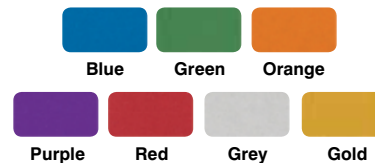
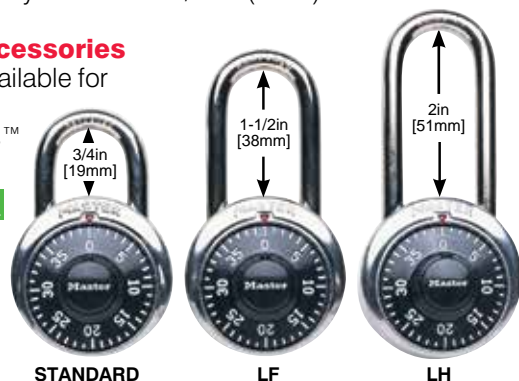

Dimensions

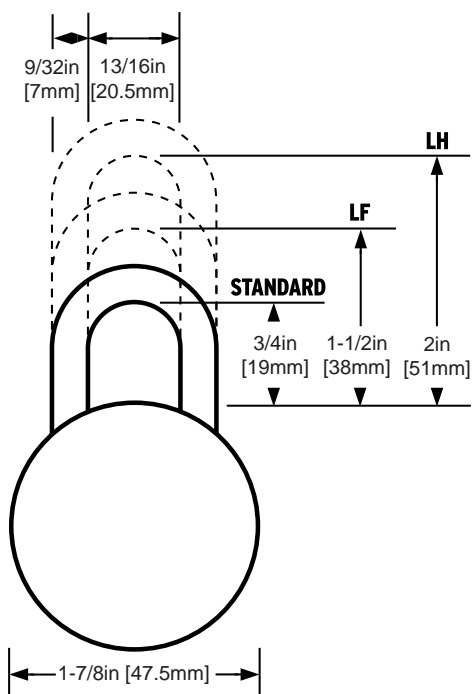

Additional Features

- Padlocks come with a charted system to keep track of combinations

Letter Lock™ 1572 & 1585 Series

PORTABLE COMBINATION LOCKS

General Security Combination Padlocks

The world's most popular combination padlocks due to their durability, reliability, convenience and affordability.

Series Models: 1572, 1585

Model 1585 has additional feature of key control for supervisory access
See Product Options for more information

Exclusive Features

- BlockGuard® Anti-Shim Technology - blocks typical shimming tools from opening the lock – deterring break-ins (U.S. Patent No. 8,099,985)
- Hardened steel shackle resists cutting and prying
- Double-reinforced stainless steel case with cold-rolled steel construction shields locking mechanism from physical attack
- 20 letter, three-digit dialing provides thousands of possible combinations
- Dial automatically locks under shackle tension to prevent “feeling out” the combination
- Combination automatically scrambles when lock is closed to prevent accidental opening
- Fits lockers with a padlock eye of at least 5/16in (8mm) diameter



Product Options and Accessories

- Longer shackle lengths available for special applications
- Custom logo or text
- Colored dials
- Bumpers – Reduce locker wear/less noise: black (1500-0620), red (1504-0620) or blue (1506-0620)
- Combinations in pairs or alike
 - Order 2 or more locks with the same combination. Allows student using multiple locks to use same combination for each lock
- Special back case printing
 - Your custom text engraved on lock backs
- Blank dialing instruction tags (1500-0590)
 - For administrative redistribution of locks

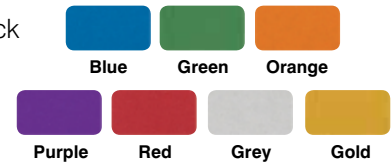

Dimensions

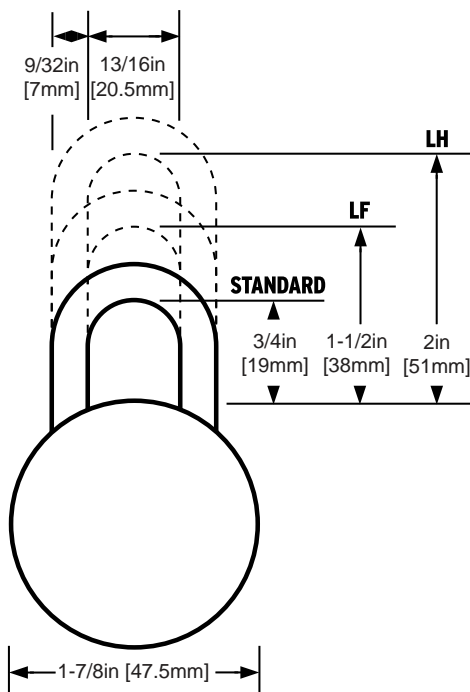

PORTABLE COMBINATION LOCKS

High Security Combination Padlocks

The highest security combination padlock available, providing three times the security of competitive padlocks.

Series Models: 2002, 2010

Model 2010 has additional feature of key control for supervisory access
See Product Options for more information

Exclusive Features

- Dual ball bearing, deadbolt locking mechanism resists hammering and prying
- Hardened, boron alloy shackle resists cutting and prying
- Reinforced, stainless steel outer case with massive, die-cast zinc inner case protects locking mechanism
- Fully recessed dial resists knock-off and prying attempts
- 40 number, three number combination provides thousands of possible combinations
- Dial automatically locks under shackle tension to prevent “feeling out” the combination
- Combination automatically scrambles when lock is closed to prevent accidental re-opening
- Fits lockers with a padlock eye of at least 11/32in (9mm) diameter

Additional Features

- 2002 and 2010 padlocks come with a charted system to keep track of combinations

Dimensions

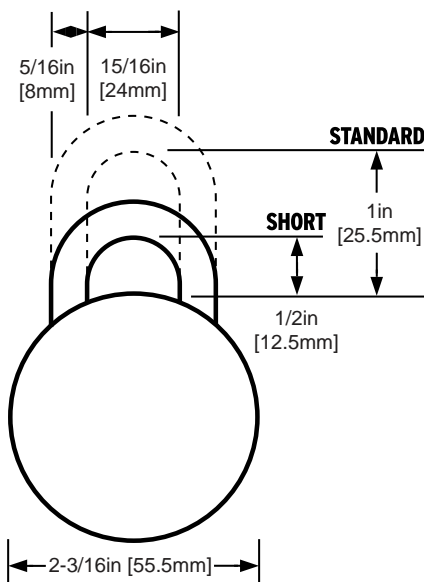

Product Options and Accessories

- Short shackle available for recessed handle lockers
- Shackle fits a padlock eye of at least 11/32in (9mm) diameter



2002 or 2010

2002S or 2010S





BUILT-IN COMBINATION LOCKS



1636MKADA/1637MKADA - Lift Handle Lockers

Works on any locker where 1630 Series locks could be used.

- 1636MKADA for right-hand hinged doors, 1637MKADA for left-hand hinged doors

1651MKADA/1656MKADA - Single Point Horizontal Latch Lockers

Works on any locker where 1652 Series locks could be used.

- 1651MKADA for left-hand hinged doors, 1656MKADA for right-hand hinged doors

1676MKADA/1677MKADA - Lift Handle, Turn Handle and Single Point Latch/Box Horizontal Latch Lockers

Works on any locker where 1670 Series locks could be used.

- 1676MKADA for right-hand hinged doors, 1677MKADA for left-hand hinged doors

1695MKADA - Single Point Wrap Around Latch™ Lockers

Works on any locker where 1690 Series locks could be used.

- 1695MKADA for right-hand hinged doors

Exclusive Features

3 Ways to Open Lock!

- Student Key (for ADA student)
 - Two keys provided with ADA keyheads
 - Key only opens one lock
- Master Key (for supervisors)
 - Each Master Key opens all ADA locks in your system
- Combination (for use like other combo locks in your system)
 - 5 combinations built in for reuse year after year
 - Automatic combination reset once door is shut
- Allows flexibility of using locker for standard use (combination) or ADA use (student key)
- Same look helps mainstream ADA students
- Key code is visible inside keyhead
- Same concealed mounting and rugged metal case as the 1630 (pg. 13), 1670 (pg. 14) and 1690 (pg. 15)



Shown Here: 1695MKADA

Shown Here: 1636MKADA

Product Options

- Metal dial available to deter vandalism; order number 1636MKMDADA, 1651MKADA, 1656MKADA, 1676MKMDADA or 1695MKMDADA
- Customize with a color – five colors to choose from

Dimensions

Fits door thickness 0.03 – 0.125in (0.8 – 3.2 mm)

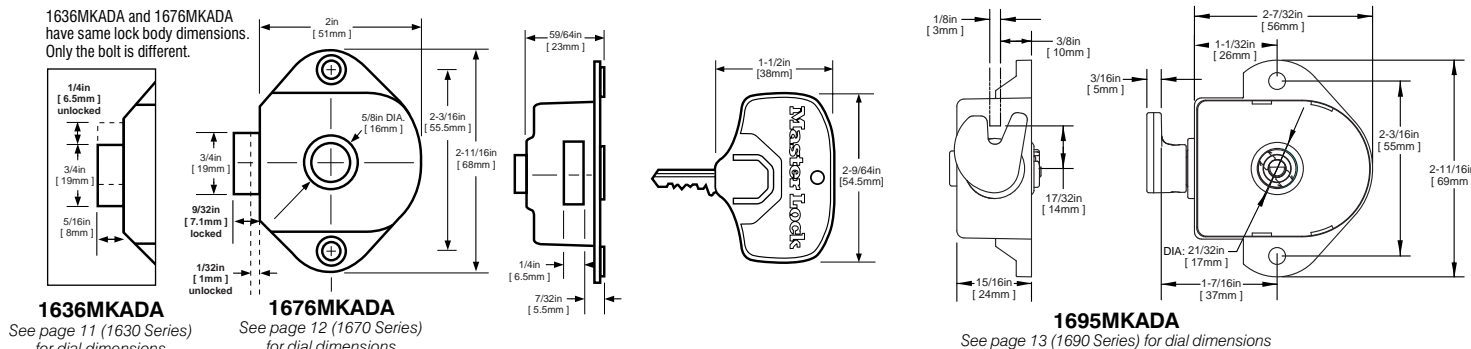

Architectural Specifications: Locks shall be both key operated and combination operated. Key operation shall use a 5 pin tumbler cylinder with individual and master keying capabilities. Locks shall have five (5) preset combinations. Locks shall have a random combination change pattern; no sequentially adjacent locks shall have the same combination change pattern. Locks shall be supplied with a printed Control Chart, containing the serial numbers and combinations. For optional one-piece metal dial specify Master Lock number 1636MKMDADA, 1676MKMDADA, or 1695MKMDADA. Add to the front of specifications as follows; For 1636MKADA: Locks shall be built-in combination lock with vertically operating bolt. For 1676MKADA: Locks shall be built-in combination lock with horizontally operating deadbolt. For 1695MKADA: Locks shall be a built-in combination lock with a rotational operating deadbolt latch that locks by wrapping around a stationary latch plate or post.



BUILT-IN KEYED LOCKS



1710ADA/1710MKADA - Single Point Horizontal Latch or Lift Handle Lockers

Works on any locker where 1710 Series locks could be used.

- 1710ADA/1710MKADA – for left-hand or right-hand hinged doors

1714ADA/1714MKADA - Single Point Horizontal Latch or Box Lockers

Works on any locker where 1714 Series locks could be used.

- 1714ADA/1714MKADA – for left-hand or right-hand hinged doors

1790ADA/1790MKADA - Single Point Wrap Around Latch™ Lockers

Works on any locker where 1790 Series locks could be used.

- 1790ADA/1790MKADA – for right-hand hinged doors

Exclusive Features

- Two keys provided for each lock
- Keys and keyheads are replaceable
- Key code is visible inside keyhead

Model 1710ADA/1710MKADA

- Manual deadbolt locking for horizontal and lift handle latch lockers

Model 1714ADA/1714MKADA

- Spring bolt locking mechanism available for box and single point latch lockers

Model 1790ADA/1790MKADA

- Designed to tolerate locker misalignment; easier installations and less adjustments for the life of the lock
- Automatic slam shut with secure deadbolt locking for Wrap Around Latch™ lockers
- Allows flexibility of adapting locker for ADA usage whenever needed
- New latch wraps around a latch plate offering the best and most secure single point latch engagement

Built-in Keyed Lock Advantages

- High security, 5-pin tumbler cylinder for superior pick resistance
- Concealed mounting & rugged metal case deter vandalism

Product Options

- Keyhead available individually, order # 1710-43959
- Keyed Alike, Master Keyed and Group Keyed options available to provide complete flexibility to match a facility's requirements



Dimensions

Fits door thickness 0.03 – 0.125in (0.8 – 3.2 mm)

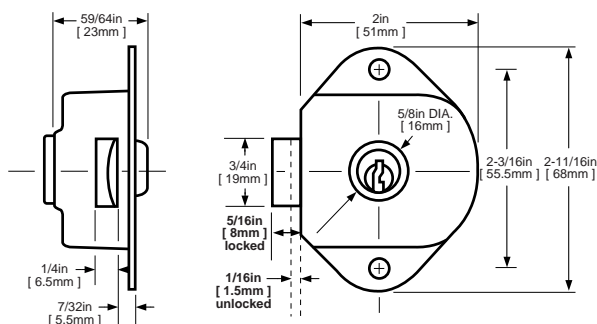

1710MKADA

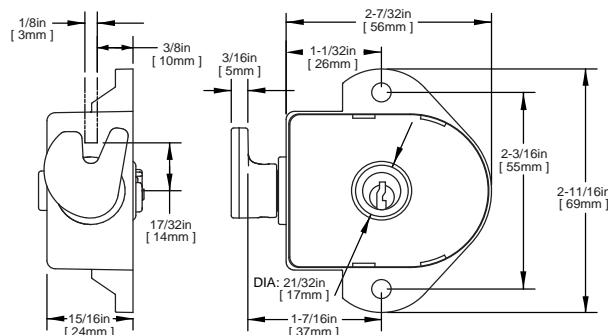
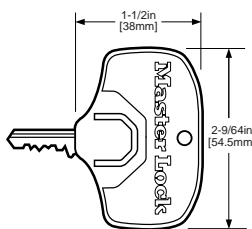

1790MKADA

Architectural Specifications: Locks shall be key-operated with 5 pin tumbler cylinder with individual, group, or master keying [specifier must choose keying option]. Two(2) keys, one(1) ADA blue key head, and mounting hardware shall be included with each lock. Specify Master Lock # 1710MKADA for horizontal deadbolt latching, Master Lock # 1714MKADA for horizontal spring bolt latching, or Master Lock # 1790MKADA for rotational deadbolt latching. For optional master keying, specify Master Lock # 1710MKADA, Master Lock # 1714MKADA, or Master Lock # 1790MKADA. For optional group keying, specify Master Lock # 1710GKADA, Master Lock # 1714GKADA, or Master Lock # 1790GKADA.



BUILT-IN ELECTRONIC LOCKS

3681 Electronic Built-In

Fits a Variety of Locker Styles



Exclusive Features

- ADA compliant with paired Bluetooth-enabled fob (included)
- Use as ADA or standard model
- High-visibility display clearly shows locker vacancy status
- Supports single & multi-user modes
- Sensors provide visual & audible jam alerts
- Long battery life with 1 CR123A lithium battery
- Clear low battery indicator
- Unique Backup Master Code simplifies facility manager access
- Strike plate included



ADA Inspired Locks



PORTABLE KEYED LOCK

PushKey™ 2650

The Model 2650 PushKey™ is a groundbreaking portable lock. Simply insert key - no turning!



Exclusive Features

- ADA Inspired - Easy-to-Use
- No key turning
- Flared lock body provides easy grip
- Less than 5 pounds of pull down force needed
- Fits most school lockers
- 4 keys included - 2 with large keyhead covers
- Exclusive key guide directs key to keyway

Easy To Operate!

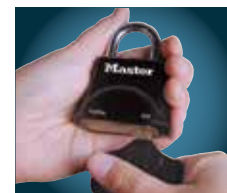

1 Insert Key

2 Let Go

3 Pull Down

The Master Lock® Advantage

UNMATCHED SERVICE

Master Lock® has a nationwide network of regional sales managers and inside account specialists as well as locker and school supply distributors. Our factory-trained sales representatives provide expert planning, product selection, lock management and support services. Master Lock sells through locker distributors that specialize in locker installation, service and repair. The school supply distributors service educational customers by consolidating multiple, related products.

COMPLETE SUPPORT

Master Lock provides a printed chart and electronic (Excel) file of every lock serial number and combination in an installation. Facility administration can use the printed chart to record locker assignments and the corresponding combination.

CONTROLLED SECURITY

Security management is crucial to any installation. Therefore, Master Lock registers authorized end users and maintains installation records in an extensive database. These records make it easy to expand your system, eliminate duplicate lock serial numbers within a system and disperse control keys by zip code to avoid key crossover between schools. Master Lock provides control keys with the original installation of a key controlled lock system. The keys provide quick, supervisory access to any lock in the system. Replacement keys are only available to registered end users, directly from Master Lock.

**Master
Lock.**



Locker and Storage Security Price List

Master Lock offers the widest range of innovative locker and storage security products available. From schools to businesses to health & recreation facilities, there's a built-in or portable solution for every need.



Education

Known for strong, reliable locker security, Master Lock specializes in providing schools with convenient and efficient administration of locker locks.

Everyone faces tight budgets, limited personnel, and time constraints. Our products are engineered to be responsive to the ever-changing landscape of educational institutions.

We make the installation and combination changing process simple and fast. Helping you save money and make the kick off to the new school year stress free.

Health & Recreation

Master Lock helps to elevate the locker room experience.

Building loyalty with a frequent flow of guests requires good service and a clean, safe and efficient environment.

Our range of portable, built-in and multi-user locker locks provides clubs and facilities with choices that optimize locker room management. The Multi-User set-your-own combination option allows staff members to focus on front desk tasks and the training required to provide great service.

Business & Employee

From manufacturing facilities to hospital buildings, Master Lock offers peace of mind like no other security company can.

Our products are strong and easy to use in the workplace and help employees and visitors feel confident that their valuables are being well protected.

We provide employers with lock options that grant supervisory access when needed.

THE MASTER LOCK ADVANTAGE

As the industry leader in locker security solutions, only Master Lock offers such a wide variety of options and customization services. We are the innovator in cost effective ADA compliant locker locks and the originator of ADA inspired locking options. Depending on your specific industry need, you can choose alternate shackle lengths for best fit, color dials that enhance user environment and custom/laser engraving for morale and identification.

Table of Contents

Terms of Sale.....	3	Built-In Combination Locks.....	8	Pricing Index.....	13
Special Programs.....	4	Built-In Keyed Locks	9	Great Technologies	14
ADA Lock Solutions.....	5	Portable Combination Locks.....	10	Service & Support	15
Electronic Built-In Locker Locks.....	6	Portable Keyed Locks.....	11		
Multi-User Combination Locks.....	7	Service Parts & Accessories Pricing.....	12		



Contact Your Preferred Distributor

Quick Ship Stock Locker Lock Program



QUICK SHIP STOCK LOCKER LOCK PROGRAM PRODUCTS

Product No.	Description	Case Qty
1525STK	General security combination different padlock with control key	50
1630STK	Built-in lift handle locker lock with control key	50
1652STK	Built-in single point latch locker lock with control key	50
1670STK	Built-in manual deadbolt locker lock with control key	50

NOTES: Quick Ship Stock Locker Lock program includes the products shown exclusively in chart. Special markings and stampings are not available. Order product by case quantity. Each case contains 1 control key and 1 combination chart. Standard freight terms apply.

ADA Lock Solutions

ADA COMPLIANCE DEFINED



The Master Lock® 1600 ADA Series and 1700 ADA Series Built-in Locks meet the United States Department of Justice "2010 ADA Standards for Accessible Design". This Standard requires 5% of lockers meet ADA specifications. In addition, these standards state that operable parts, the locks, meet the following requirements:

- Shall be operable with one hand
- Shall not require tight grasping, pinching, or twisting of the wrist to operate
- Shall have a force required to activate of 5 lbf (22.2N) maximum

Master Lock ADA Compliant Locker Locks achieve these requirements through the use of a specially designed keyhead and the simple operation of the lock. The large flat keyhead makes the key easy to grip for those with extreme joint pain. For those with clenched fist dexterity, the flat keyhead fits securely between their fingers. The operation of the lock can be achieved by a simple bumping action to the ADA keyhead to both open and close the lock without the need of tight grasping, pinching, or twisting of the wrist.

Many of these locks are already in use in the field for ADA applications.

As needs and requirements vary, please consult the local authority regarding use of any of these locks for a specific application.



1600 ADA SERIES BUILT-IN COMBINATION LOCKS WITH STUDENT KEY/ MASTER KEY

Three-Ways-To-Open™ technology lock:

- Student Key for ADA users (opens 1 lock)
- Master Key for supervisors (opens all ADA locks in your system)
- Combination for use like other combo locks in your system (5 combinations built in for reuse year after year)

Two keys with ADA keyheads included; order Master Keys separately
Left hand models available; see chart



1636MKADA
For Multi-Point Latch, Lift Handle Lockers

1656MKADA
For Single Point Horizontal Latch Lockers, Springbolt Operation

1676MKADA
For Single Point or Multi-Point Horizontal Latch Lockers, Deadbolt Operation

1695MKADA
For Single Point Wrap Around Latch™ Lockers



1700 SERIES BUILT-IN KEY ONLY LOCKS

- Simple and economical solution for lockers for those with special needs
 - Each includes two keys, one with large ADA key head.
- Order Master Keys separately.



1710MKADA
For Single Point or Multi-Point Latch Lockers, Deadbolt Operation

1714MKADA
For Single Point Latch Lockers, Springbolt Horizontal Operation

1790MKADA
For Single Point Wrap Around Latch™ Lockers



ADA Keyhead

1710-43959

Converts provided keys to meet ADA requirements

ADA Lock Selection Guide

Master Lock Product #	Locker Hinge Orientation	Reduced Physical Abilities	Reduced Cognitive Abilities	Same Function as Model
-----------------------	--------------------------	----------------------------	-----------------------------	------------------------

ADA COMPLIANT BUILT-IN LOCKER LOCKS



1636MKADA	Right Hand	✗	✗	1630
1637MKADA	Left Hand	✗	✗	1631
1656MKADA	Right Hand	✗	✗	1652
1651MKADA	Left Hand	✗	✗	1653
1676MKADA	Right Hand	✗	✗	1670
1677MKADA	Left Hand	✗	✗	1671
1695MKADA	Right Hand	✗	✗	1690
1710MKADA	Right or Left Hand	✗	✗	1710MK
1714MKADA	Right or Left Hand	✗	✗	1714MK
1790MKADA	Right Hand	✗	✗	1790MK

ADA INSPIRED PORTABLE LOCKER LOCKS



1525EZRC	Right or Left Hand	-	✗	1525
2650	Right or Left Hand	✗	✗	-

ADA INSPIRED DEFINED



Master Lock ADA Inspired locks address special needs beyond those outlined in the "2010 ADA Standards for Accessible Design". These portable locks are designed to be easy to use and assist those with physical or cognitive challenges operate a lock independently. All ADA Inspired locks fit most standard lockers.



1525EZRC Simple Combos™

- Simple Combos™ – specially selected combinations that use only numbers printed on the dial (no sub-increments) so users can more easily recall and dial their combination
- Supervisory key override matches existing Master Lock portable systems, plus key can also be matched with many built-in combination lock systems
- Colored dials – black, green, purple, red, blue, orange, grey or gold, and customization with your logo or text available



2650 PushKey™

- Easy-to-open and simple-to-use – simply insert the key and pull down on the flared, easy-to-grip body to open (no key turning required)
- Includes four keys, two with large key head covers for ease of gripping.

Electronic Built-In Locker Lock



How It Works

1. Enter four to six digit personal code
2. Press the check-mark button
3. Display screen shows locked icon



Exclusive Features



- High visibility display provides interactive feedback
- A single CR123 3V lithium battery lasts longer to help minimize maintenance
- Electromechanical deadbolt enhances security
- Enhanced design to withstand humid environments
- Visual and audible alerts to signal if locking mechanism is blocked
- High-gloss keypad allows user to easily create personal code
- Clear identification of locker vacancy

Benefits



- Intuitive operation to customize lock settings
- Ease of use with the simple lock and unlock instructions
- Ability to set a personal code
- Unique master backup code allows administrative access to locker

Product Options

- Single-user and multi-user lock modes
- Set code length to 4, 5, and 6 digits
- Administration key allows setting changes
- Bluetooth®/ADA FOB used with the 3681 Model
- Suitable for most lockers - metal, wood or phenolic

	Product No.	Description	Case Qty.
	3685	Electronic Built-In Locker Lock – Fits most standard lockers. Reversible design for both left or right hinged locker doors	12
	3681	Electronic Built-In Locker Lock includes 1 programmed Bluetooth®/ADA Fob. Fits most standard lockers. Reversible design for both left or right hinged locker doors. Additional Bluetooth®/ADA Fobs sold separately.	12

Options and Accessories

	1566	Administration Key– Allows fast and easy locker access and changes to lock settings. Can be used with 3685 and 3681 models.	36
	3686	Bluetooth®/ADA Fob – the 3681 model includes 1 programmed Bluetooth®/ADA Fob for ADA applications.	48

Multi-User Mechanical Locks



How It Works

1. Spin the Dials to Personalized 3-Digit Combination
2. Turn the Knob to the  Icon
3. Scramble the Dials



3630



3631



3670

Exclusive Features



- Intuitive, easy-to-use design
- Set-your-own 3-digit combination
- Retains current combination until re-set
- Sleek design with satin finish

Built-In Multi-User Lock Advantages

- Designed for multiple use in a day for high customer turnover facilities
- Eliminates distribution, tracking and management of keys, combination or locks
- Concealed mounting and rugged zinc case
- Standard key control allows quick supervisory access
- End user registration provided to secure and simplify administration

Product Options

- Model 3670
 - for left-handed & right-handed hinged doors
 - for lift handle lockers
 - for single point latch lockers
 - manual deadbolt locking
- Model 3630
 - for right-handed hinged doors
 - for lift handle lockers
 - manual spring locking
- Model 3631
 - for left-handed hinged doors
 - for lift handle lockers
 - manual spring locking
- Extension Kit available for doors with a thickness of 11/16in (17mm) to 3/4in (19mm) #3630-0320

	Product No.	Description	Case Qty.
 	3630	Set-Your-Own combination lock - For standard lift handle lockers - manual deadbolt locking, right-hand hinged door - override key sold separately	1
	3631	Set-Your-Own combination lock - For standard lift handle lockers - manual deadbolt locking, left-hand hinged door - override key sold separately	1
	3670	Set-Your-Own combination lock - For lift handle, turn handle and single point latch/box horizontal latch lockers - manual deadbolt locking, right-hand or left-hand hinged door - override Key sold separately	1

Options and Accessories



K3630	Supervisory override key	1
3630-0320	Extension Kit for doors with a thickness of 11/16in (17mm) to 3/4in (19mm)	1
3633LES	English/Spanish user instruction magnets – 4in (102mm) x 6in (152mm)	10
3633LEF	English/French user instruction magnets – 4in (102mm) x 6in (152mm)	10
3634LES	English/Spanish user instruction stickers – 4in (102mm) x 6in (152mm)	10
3634LEF	English/French user instruction stickers – 4in (102mm) x 6in (152mm)	10



Built-In Combination Locks

	Product No.	Description	Case Qty.
1630 SERIES - FOR LIFT HANDLE LOCKERS			
	1630	Automatic locking, for right-hand hinged door	50
	1631	Automatic locking, for left-hand hinged door	50
	1636MKADA	ADA version of 1630 lock - Master Key enabled. Includes 2 student keys (only opens one lock) with ADA key heads. Order Master Key separately	50
	1637MKADA	ADA version of 1631 lock - Master Key enabled. Includes 2 student keys (only opens one lock) with ADA key heads. Order Master Key separately	50
1652 & 1654 SERIES - FOR SINGLE POINT LATCH LOCKERS & BOX LOCKERS			
	1652	For Single Point Latch Lockers - Automatic locking, for right-hand hinged door - button-less combination change	50
	1653	For Single Point Latch Lockers - Automatic locking, for left-hand hinged door - button-less combination change	50
	1654	For Box Lockers - Automatic locking, for right-hand hinged door	50
	1655	For Box Lockers - Automatic locking, for left-hand hinged door	50
	1651MKADA	ADA version of 1653 lock - Master Key enabled. Includes 2 student keys (only opens one lock) with ADA key heads. Order Master Key separately - Button-less combination change	50
	1656MKADA	ADA version of 1652 lock - Master Key enabled. Includes 2 student keys (only opens one lock) with ADA key heads. Order Master Key separately - Button-less combination change	50
1670 SERIES - FOR ALL LOCKERS (EXCEPT WRAP AROUND LATCH™)			
	1670	Manual deadbolt locking, for right-hand hinged doors	50
	1671	Manual deadbolt locking, for left-hand hinged doors	50
	1676MKADA	ADA version of 1670 lock - Master Key enabled. Includes 2 student keys (only opens one lock) with ADA key heads. Order Master Key separately	50
	1677MKADA	ADA version of 1671 lock - Master Key enabled. Includes 2 student keys (only opens one lock) with ADA key heads. Order Master Key separately	50
1690 SERIES - FOR SINGLE POINT LATCH LOCKERS - WRAP AROUND LATCH™ TECHNOLOGY			
	1690	Automatic deadbolt locking, for right-hand hinged door	50
	1695MKADA	ADA version of 1690 lock - Master Key enabled. Includes 2 student keys (only opens one lock) with ADA key heads. Order Master Key separately	50
Options and Accessories			
  	K1630	Control key for built-in combination locker locks (Except 1695MKADA)	1
	K1695	Cut user key for 1600MKADA Series locks. Order ADA key head separately. (Note: each 1600MKADA Series lock includes 2 user keys with ADA key heads.)	1
	K1695CM	Cut Master Key for 1600MKADA Series locks	1
	1654-0320	Extension set for doors with a thickness of 11/16in (17mm) to 3/4in (19mm). Works for all built-in combination locks (Excluding the Multi-User models)	1
	MD	Black Metal Dial – available on all built-ins – add “MD” to Product No. (e.g. 1630MD)	-
	Colored Dials	Colored Dials are available in Metal Dials - must add the following prefixes to specify color: Blue (MDBLU), Green (MDGRN), Red (MDRED) or Purple (MDPRP).	-
	IMPC	Special Back Case Printing - 100 locks minimum, initials or numbers up to seven characters, on back case	-
	ADA	Americans with Disabilities Act Compliant Key Head - available on any 1710, 1714 or 1790 - add “ADA” to product number (e.g. 1710ADA) Includes 1 key head cover per lock	-
	Note: All built-in products - Order Control Key / Master Key separately. User keys included with key operated locks, 1600ADA locks and all 1700 series locks		

Built-In Keyed Locks







	Product No.	Description	Case Qty.
	1710	For all lockers (except Wrap Around Latch™) - Manual deadbolt locking, fits both right- and left-hand hinged doors. Includes 2 user keys	50
	1714	For all lockers (except Wrap Around Latch™) - Automatic locking, fits both right- and left-hand hinged doors. Includes 2 user keys	50
	1790	For Keyed Only Single Point Latch Lockers - Wrap Around Latch™ Technology - automatic deadbolt locking, for right-hand hinged door. Includes 2 user keys.	50
	1710MKADA	ADA version of 1710 lock - Master Key enabled. Includes 2 student keys (only opens one lock) with 1 ADA keyhead. Order Master Key separately	50
	1714MKADA	ADA version of 1714 lock - Master Key enabled. Includes 2 student keys (only opens one lock) with 1 ADA keyhead. Order Master Key separately	50
	1790MKADA	ADA version of 1790 lock - Master Key enabled. Includes 2 student keys (only opens one lock) with 1 ADA keyhead. Order Master Key separately	50

Options and Accessories









 Control Key  ADA Key Head	KA	Keyed Alike - available on 1710, 1714 and 1790. Add "KA" to end of Product No. (e.g. 1710KA)	-
	MK	Master Keyed - available on 1710, 1714 and 1790. Add "MK" to end of Product No. (e.g. 1710MK)	-
	K1710W81KM	Cut Master Key for 1710MK, 1714MK and 1790MK locks	1
	K1710W81	Cut regular key for 1710, 1714, 1790, 1710MK, 1714MK and 1790MK locks	1
	K1710KMBOX	Box of 50 key blanks for 1710MK, 1714MK and 1790MK	50/box
	K1710BOX	Box of 50 key blanks for 1710, 1714 and 1790	50/box
	RMVK	Removable Key Feature - available in locked and unlocked positions	-
	IMPC	Special Back Case Printing - 100 locks minimum, initials or numbers up to seven characters, on back case	-
	ADA	Americans with Disabilities Act Compliant Key Head - available on any 1710, 1714 or 1790 - add "ADA" to product number (e.g. 1710ADA) Includes 1 key head cover per lock	-

Note: All built-in products - Order Control Key / Master Key separately. User keys included with key operated locks, 1600ADA locks and all 1700 series locks









Portable Combination Locks

	Product No.	Description	Case Qty.	
HIGH SECURITY COMBINATION PADLOCKS A: 5/16in (8mm) C: 15/16in (24mm)				
 2010 shown	2010	Combination Different - Control key feature, B: standard 1in (25mm) shackle height	50	
	2010S	Combination Different - Control key feature, B: short 1/2in (13mm) shackle height, recommended for recessed handle lockers	50	
Options and Accessories				
 Control Key	K1525	Control key for 2010 padlocks	1	
	TIS	Combinations in pairs - Order 2 or more locks with the same combination. Locks are packed in serial number sequence, the user may easily match up individual locks	-	
	KA	Combinations Alike - Any quantity available at no charge	-	
	IMPC	Special Back Case Printing - 100 locks minimum, initials or numbers up to seven characters, on back case	-	
GENERAL SECURITY COMBINATION PADLOCKS A: 9/32in (7mm) C: 13/16in (21mm)				
 1502 shown	1502	Combination Different - B: standard 3/4in (19mm) shackle height	25	
	1502LF	Combination Different - B: standard 1-1/2in (38mm) shackle height	36	
	1502LH	Combination Different - B: 2in (51mm) shackle height	36	
	1525	Combination Different - Control Key feature, B: standard 3/4in (19mm) shackle height	25	
	1525LF	Combination Different - Control Key feature, B: 1-1/2in (38mm) shackle height	36	
	1525LH	Combination Different - Control Key feature, B: 2in (51mm) shackle height	36	
	1525EZRC	Combination Different - Control key feature, B: standard 3/4in (19mm) shackle height Simple Combos™ for Easy-To-Remember Combinations	36	
 1502LFORJ shown	1572	Letter Combination Different - B: standard 3/4in (19mm) shackle height	25	
	1572LF	Letter Combination Different - B: 1-1/2in (38mm) shackle height	36	
	1572LH	Letter Combination Different - B 2in (51mm) shackle height	36	
	1585	Letter Combination Different - Control Key feature, B: 3/4in (19mm) shackle height	25	
	1585LF	Letter Combination Different - Control Key feature, B: 1-1/2in (38mm) shackle height	36	
	1585LH	Letter Combination Different - Control Key feature, B: 2in (51mm) shackle height	36	
	1572LFBLU shown			
 1572LFBLU shown	Options and Accessories			
		K1525	Control Key for 1525 padlocks	1
		TIS	Combinations in pairs - order 2 or more locks with the same combination. Locks are packed in serial number sequence, the user may easily match up individual locks	-
		KA	Combinations Alike - Any quantity available at no charge	-
		Colored Dials	Colored Dials are available in Metal Dials - must add the following prefixes to specify color: Blue (BLU), Green (GRN), Red (RED), Purple (PRP) Orange (ORJ), Gold (GLD) or Grey (GRY).	-
		LZ1	Laser Engraved Dial - same as above but image/text etched into dial. No set-up charge	-
		IMPC	Special Back Case Printing - 100 locks minimum, initials or numbers up to seven characters, on back case	-
		1500-0620	Black bumpers – reduce locker wear and noise	200/bag

Portable Keyed Locks

	Product No.	Description	Case Qty.
GENERAL SECURITY KEYED PADLOCKS A: 9/32in (7mm) C: 13/16in (21mm)			
	2650	PushKey™ no key turn portable lock - 4 keys included: 2 with large key head covers B: 3/4in (19mm) shackle	24
Options and Accessories			
	K2650BOX	Box of 25 key blanks	25 per box
	1710-43959	ADA Compliant key head. (Note: 2650 comes with 4 keys and 2 key heads)	-
HIGH SECURITY SOLID ALUMINUM PADLOCKS A: 5/16in (8mm) C: 3/4in (19mm)			
	A1205	1-3/4in (38mm) wide padlock with B: 1-1/8in (28mm) boron shackle	24
	A1265	1-3/4in (38mm) wide padlock with B: 1-1/8in (28mm) boron shackle, 6-pin cylinders	24
Options and Accessories			
	KA	Keyed Alike	-
	MK	Master Keyed	-
	KAMK	Keyed Alike; Master Keyed	-
	CN	#40 Sash Chain, 9in (23cm) long, zinc plated	-
	NR	Non-removable Key	-
	Color Options	Lock body colors available - Black (BLK), Blue (BLU), Brown (BRN), Clear (CLR), Green (GRN), Orange (ORJ), Purple (PRP), Red (RED), Yellow (YLW). Add to Product No. (e.g. A1205BLU)	-
	Laser Engraving Option	Laser engraving available on 6 different surface areas of the lock. Please contact your Customer Care Representative for details	-
COMMERICAL MAGNUM® PADLOCKS B: 1in (25mm)			
	M1STS	Laminated Steel Padlock with Stainless Steel Body Cover A: 5/16in (8mm) C: 13/16in (21mm)	24
	M5STS	Laminated Steel Padlock with Stainless Steel Body Cover A: 5/16in (8mm) C: 13/16in (21mm)	24
LAMINATED STEEL PADLOCKS A: 9/32in (7mm) C: 5/8in (16mm)			
	3	Laminated steel body with hardened steel B: 3/4in (19mm) shackle	24
Options and Accessories			
	KA	Keyed Alike	-
	MK	Master Keyed	-
	KAMK	Keyed Alike; Master Keyed	-
	LF	Hardened steel 1-1/2in (38mm) shackle (3 and 11 Option Only) Octagonal Boron Shackle, B = 1-1/2in (38mm) (M1 STS and M5 STS Option Only)	-
	LH	Hardened steel 2in (51mm) shackle (3 and 11 Option Only)	-
	LJ	Octagonal Boron Shackle, B = 2-1/2in (64mm) (M1 STS and M5 STS Option Only)	-
CN	# 40 Sash Chain, 9in (23cm) long, zinc plated	-	

Service Parts and Accessories Pricing

	Model									
										
Parts	1630/ 1631	1652/ 1653	1654/ 1655	1670/ 1671	1690	1790	1710/ 1714	1502/ 1525	2010	
1500-0590 Blank Dialing Instruction Tags								●		
1500-0620 Black Bumpers (Bag of 200)								●		
1630-0035 Bag (50) Kep Nuts	●	●	●	●	●	●	●			
1630-0313 Dial, Escutcheon Plate, Cylinder Assembly	●	○	○	●	○					
1710-0390 Nuts & Bolts (Bag of 50)						●	●			
1710-43959 ADA Compliant Key Head (Key available separately)						●	●			

● Recommended ○ Works - but other recommended

Pricing Index

MOST POPULAR PRODUCT OPTION PRICING (not all options shown)

IMPORTANT!

When ordering, please review Ordering Information under the Terms of Sale.

See
Page
3

PRODUCT SELECTION

Product Number	Product Number
3	1677MKADA
3MK	1690
1502	1695MKADA
1502KA	1710
1502LF	1710ADA
1502LH	1710KA
1525	1710KAMK
1525EZRC	1710KAMKRMVK
1525IMPC	1710MK
1525KA	1710MKADA
1525LF	1710MKRMVK
1525LH	1710RMVK
1525STK	1714
1525TIS	1714ADA
1566	1714KA
1572	1714KAMK
1585	1714MK
1630	1714MKADA
1630KA	1790
1630MD	1790ADA
1630STK	1790KA
1631	1790KAMK
1631MD	1790KAMKRMVK
1636MKADA	1790KARMVK
1637MKADA	1790MK
1651MKADA	1790MKADA
1652	1790MKRMVK
1652MD	1790RMVK
1652STK	2010
1653	2010KA
1654	2010S
1654KA	2010SIMPC
1654MD	2650
1655	3630
1655KA	3631
1655MD	3670
1656MKADA	3681
1670	3685
1670KA	3686
1670MD	A1205BLK
1670STK	A1205MKBLK
1671	A1265BLK
1671KA	A1265MKBLK
1671MD	M1STS
1676MKADA	M5STS

PARTS & SERVICE

Product Number	Description
1500-0590	Blank Dialing Tags 1502/1525
1500-0620	Black Rubber Bumper 1502/1525 Qty. 200
1630-0035	Nuts for Built-In Combo Locks
1630-0313	Complete Built-In Combo Dial Assembly for 1630/1631
1710-0390	Nuts & Bolts for 1710/1714/1790 Qty. 50
1710-43959	ADA Compliant Key Head – Order key separately
K1525	Control Key for 1525/2076/2010
K1630	Control Key for all Built-In Combo Locks except ADA locks
K1695CRM	Cut Student Key/Change Key for all ADA Built-In Combo Locks
K1695CM	Cut Master Key for all ADA Built-In Combo Locks
K1710W81KM	Cut Master Key for 1710/1714/1790
K1710W81	Cut Regular Key for 1710/1714/1790
K2650BOX	Box of 25 key blanks
K3630	Supervisory override key

Button-Less Combination Change

**No Buttons to Push. No Doors to Open.
No Accidental Combination Changes.**

The redesigned 1652 Series now features a patent-pending button-less combination change process that allows you to switch to the next combination without having to open the locker door! Sporting an all-new sleek dial design, this lock saves on overall maintenance time and prevents accidental combination change by overstuffed lockers.



BlockGuard® Anti-Shim Padlock Technology

Advances Padlock Security to the Next Level.

Leading the market with innovative security solutions, Master Lock® offers the patented BlockGuard® Anti-Shim Technology – the very best in shim deterrence for combination padlocks.

These enhanced combination locks deter shimming, a method of violating a lock by inserting a specially designed shim tool into its latch mechanism. BlockGuard® has unique flat latch technology that actually blocks typical shim tools from opening the lock – deterring break-ins.

Master Lock exclusive BlockGuard® Anti-Shim Technology (U.S. Patent No. 8,099,985) is now available on Models 1502, 1525, 1572, 1585 and 2076.



Wrap Around Latch™ Technology

The Best Lock for Single Point Latch Lockers!

The patented model 1690, 1695MKADA, and 1790 built-in locks use the same technology as an automotive door lock system, utilizing slam shut operation combined with a rotating latch that wraps around the latch plate. Designed for Single Point Latch Lockers, these locks provide the most robust design and requires the least adjustment for proper operation (U.S. Patent No. 7,984,630).



Latch Wraps Around The Latch Plate

Less Maintenance, More Security, Easy-To-Use

EXTREMELY SHIM RESISTANT

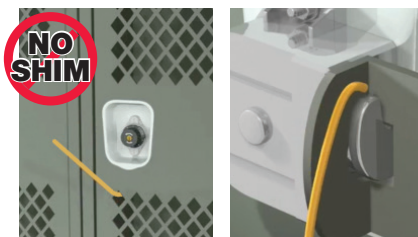

Even in the case of ventilated lockers the 1690/1790 hold strong as the Wrap Around Latch™ prevents the use of shims and similar techniques for opening the door. Dead bolt latch automatically locks in position once the locker door is shut, preventing defeating the lock through attempts to move or shim the lock.

INCREASED HORIZONTAL TOLERANCE

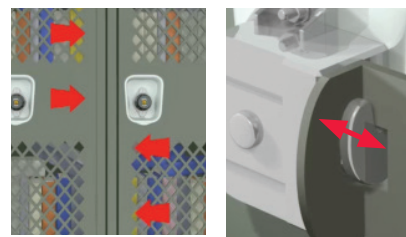

A wider operating range reduces the need for call backs or future maintenance adjustments. This saves your facility time and money. The 1690 design offers a much wider operating range.

**Master
Lock®**



DOOR HARDWARE PRODUCT CATALOG

RESIDENTIAL | MULTI-FAMILY | COMMERCIAL



MASTER LOCK® DOOR HARDWARE

CONTENTS

RESIDENTIAL DOOR HARDWARE

History of Innovation	Page 5
Selection Guide	Page 7
Knobs, Levers and Handlesets	
Biscuit Knobs (BC)	Page 8
Biscuit Knob Handlesets (HDLBC)	Page 9
Rusk Knobs (RU)	Page 10
Tulip Knobs (TU)	Page 11
Ball Knobs (BA)	Page 12
Wave Levers (WL)	Page 13
Wave Lever Handlesets (HDLWL)	Page 14
Return Levers (RL)	Page 15
Straight Levers (SL)	Page 15
Deadbolts	
Grade 1 Single Cylinder (DSH)	Page 16
Grade 1 Double Cylinder (DSH)	Page 16
Grade 3 Single Cylinder (DSO)	Page 17
Grade 3 Double Cylinder (DSO)	Page 17
Replacement Cylinders	
Knob, Lever & Deadbolt Cylinders	Page 18
Specifications / Dimensions	
Grade 3 Knobsets	Page 19
Grade 3 Leversets	Page 20
Grade 3 Handleset	Page 20
Grade 3 Deadbolts	Page 20
Grade 1 Deadbolts	Page 20

COMMERCIAL DOOR HARDWARE

Commercial Grade 2 Door Hardware	Page 22
Commercial Grade 2 Door Hardware	Page 23
Grade 2 Door Hardware	
Cylindrical Ball Knob	Page 24
Cylindrical Lever	Page 24
Heavy-Duty Cylindrical Lever (SLC)	Page 24
Deadbolts (DSC)	Page 24
Heavy-Duty Deadbolts	Page 24
Specifications / Dimensions	
Cylindrical Ball Knob	Page 25
Cylindrical Lever	Page 25
Heavy-Duty Cylindrical Lever	Page 25
Deadbolts	Page 25
Heavy-Duty Deadbolts	Page 25
MERCHANDISING	
Demo/Display Mounts	Page 26



MASTER LOCK® DOOR HARDWARE

HISTORY OF INNOVATION

Throughout our history, Master Lock® has worked hard to earn and maintain the trust of our customers by delivering on our promise of strength and quality, and by continually seeking new standards for product design, application and performance.

From the groundbreaking laminated padlock design that launched the Master Lock Company in 1921 to the thousands of products that followed, spanning a wide range of security hardware categories, one thing has remained constant. Every Master Lock product is the end result of hard work by a dedicated team, driven by a passion for innovation and a steadfast commitment to quality. As a result, our customers know what they can expect when they purchase any product that bears the Master Lock name.

Master Lock brings this same innovation and expertise to our extensive line of Residential and Commercial Door Hardware.





RESIDENTIAL DOOR HARDWARE

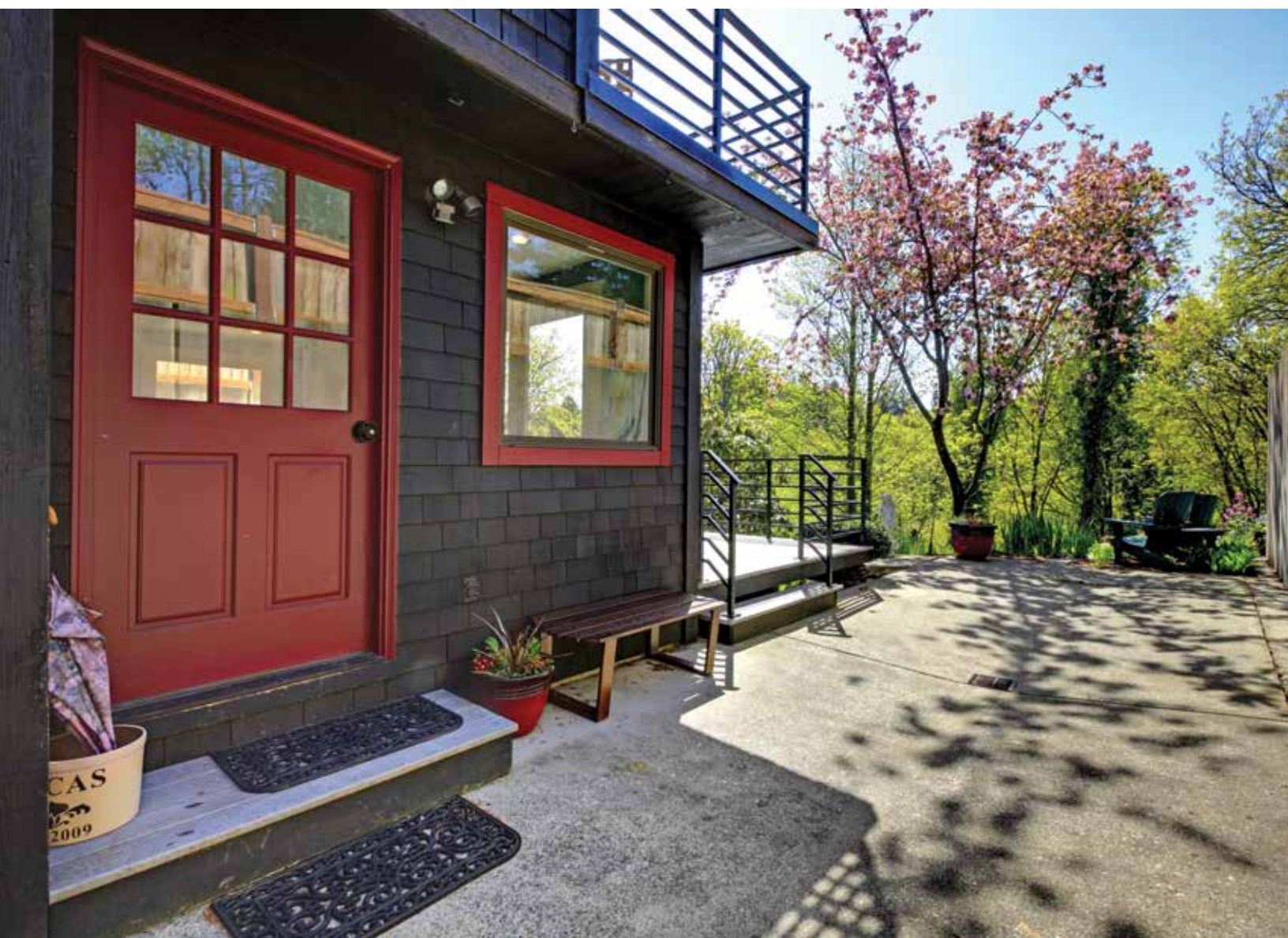

RESIDENTIAL SELECTION GUIDE

1 HANDLE STYLE



2 FUNCTION



3 FINISH



4 CUSTOMIZATION

KEYED DIFFERENT (KD)

Each lock is opened by its own unique key. Keyed Different is the standard keying default option.



KEYED ALIKE (KA)

All locks in the set are opened by the same key. Keyed Alike locks eliminate the need for multiple keys where numerous locks are used.



MASTER KEYED (MK)





In a Master Keyed system, a master key opens all the locks in the system, although each lock has its own unique key. Master Keyed systems allow supervisory or emergency access.



RESIDENTIAL DOOR HARDWARE

GRADE 3 KNOBS

BISCUIT KNOBS (BC)

FINISH	DESCRIPTION	RETAIL PACK MASTER CARTON QTY: 2	BOX PACK MASTER CARTON QTY: 8			
			KW1	SC1	WR5	WK2
Polished Brass (03) 	Keyed Entry	BC00103	BC0103KA4	BC0103KA4S	BC0103KA4W	BC0103KA4WK
	Privacy	BC00303	BC0303BOX			
	Passage	BC00403	BC0403BOX			
	Dummy	—	BC0503BOX			
	Storeroom	—	BC0203KA4	BC0203KA4S	—	—
Antique Brass (05) 	Keyed Entry	BC00105	BC0105KA4	BC0105KA4S	BC0105KA4W	BC0105KA4WK
	Privacy	BC00305	BC0305BOX			
	Passage	BC00405	BC0405BOX			
Satin Nickel (15) 	Keyed Entry	BC00115	BC0115KA4	BC0115KA4S	BC0115KA4W	BC0115KA4WK
	Privacy	BC00315	BC0315BOX			
	Passage	BC00415	BC0415BOX			
	Dummy	—	BC0515BOX			
	Storeroom	—	BC0215KA4	BC0215KA4S	—	—
Aged Bronze (12P) 	Keyed Entry	BC00112P	BC0112PKA4	BC0112PKA4S	BC0112PKA4W	BC0112PKA4WK
	Privacy	BC00312P	BCC0312PBOX			
	Passage	BC00412P	BCC0412PBOX			
	Dummy	—	BCC0512PBOX			
	Storeroom	—	BC0212PKA4	BC0212PKA4S	—	—

BISCUIT KNOB COMBO PACKS (BC)

FINISH	DESCRIPTION	RETAIL PACK MASTER CARTON QTY: 2	BOX PACK MASTER CARTON QTY: 4			
			KW1	SC1	WR5	WK2
Polished Brass (03)	Single Cylinder Deadbolt Combo Pack	BCC00603	BCC0603KA4	BCC0603KA4S	BCC0603KA4W	BCC0603KA4WK
Antique Brass (05)	Single Cylinder Deadbolt Combo Pack	BCC00605	BCC0605KA4	BCC0605KA4S	BCC0605KA4W	BCC0605KA4WK
Satin Nickel (15)	Single Cylinder Deadbolt Combo Pack	BCC00615	BCC0615KA4	BCC0615KA4S	BCC0615KA4W	BCC0615KA4WK
Aged Bronze (12P)	Single Cylinder Deadbolt Combo Pack	BCC00612P	BCC0612PKA4	BCC0612PKA4S	BCC0612PKA4W	BCC0612PKA4WK

Box Pack product is packaged in KA4 sets with 2 different KA4 sets per Master Carton of 8. Retail Pack product is Keyed Different.

RESIDENTIAL DOOR HARDWARE

GRADE 3 HANDLESETS

BISCUIT KNOB HANDLESETS (HDLBC)

FINISH	DESCRIPTION	RETAIL PACK MASTER CARTON QTY: 2	BOX PACK MASTER CARTON QTY: 2			
			KW1	SC1	WR5	WK2
Polished Brass (03) 	Single Cylinder Deadbolt with Biscuit Knob	HDLBC0603	HDLBC0603KA4	HDLBC0603KA4S	HDLBC0603KA4W	HDLBC0603KA4WK
Antique Brass (05) 	Single Cylinder Deadbolt with Biscuit Knob	HDLBC0605	HDLBC0605KA4	HDLBC0605KA4S	HDLBC0605KA4W	HDLBC0605KA4WK
Satin Nickel (15) 	Single Cylinder Deadbolt with Biscuit Knob	HDLBC0615	HDLBC0615KA4	HDLBC0615KA4S	HDLBC0615KA4W	HDLBC0615KA4WK
Aged Bronze (12P) 	Single Cylinder Deadbolt with Biscuit Knob	HDLBC0612P	HDLBC0612PKA4	HDLBC0612PKA4S	HDLBC0612PKA4W	HDLBC0612PKA4WK

Box Pack product is packaged in KA4 sets with 2 different KA4 sets per Master Carton of 8. Retail Pack product is Keyed Different.

RESIDENTIAL DOOR HARDWARE

GRADE 3 KNOBS

RUSK KNOBS (RU)

FINISH	DESCRIPTION	RETAIL PACK MASTER CARTON QTY: 2	BOX PACK MASTER CARTON QTY: 8			
			KW1	SC1	WR5	WK2
Polished Brass (03) 	Keyed Entry	—	RU0103KA4	RU0103KA4S	RU0103KA4W	—
	Privacy	—	RU0303BOX			
	Passage	—	RU0403BOX			
	Dummy	—	RU0503BOX			
	Storeroom	—	RU0203KA4	RU0203KA4S	—	—
Antique Brass (05) 	Keyed Entry	—	RU0105KA4	RU0105KA4S	RU0105KA4W	—
	Privacy	—	RU0305BOX			
	Passage	—	RU0405BOX			
	Dummy	—	RU0505BOX			
	Storeroom	—	RU0205KA4	RU0205KA4S	—	—
Satin Nickel (15) 	Keyed Entry	—	RU0115KA4	RU0115KA4S	RU0115KA4W	—
	Privacy	—	RU0315BOX			
	Passage	—	RU0415BOX			
	Dummy	—	RU0515BOX			
	Storeroom	—	RU0215KA4	RU0215KA4S	—	—
Aged Bronze (12P) 	Keyed Entry	—	RU0112PKA4	RU0112PKA4S	RU0112PKA4W	—
	Privacy	—	RU0312PBOX			
	Passage	—	RU0412PBOX			
	Dummy	—	RU0512PBOX			
	Storeroom	—	RU0212PKA4	RU0212PKA4S	—	—

Box Pack product is packaged in KA4 sets with 2 different KA4 sets per Master Carton of 8. Retail Pack product is Keyed Different.

RESIDENTIAL DOOR HARDWARE

GRADE 3 KNOBS

TULIP KNOBS (TU)

FINISH	DESCRIPTION	RETAIL PACK MASTER CARTON QTY: 2	BOX PACK MASTER CARTON QTY: 8			
			KW1	SC1	WR5	WK2
Polished Brass (03) 	Keyed Entry	TU00103	TU0103KA4	TU0103KA4S	TU0103KA4W	TU0103KA4WK
	Privacy	TU00303	TU0303BOX			
	Passage	TU00403	TU0403BOX			
	Keyed Entry, Twin Set	TU00103T	—			
	Keyed Entry, Mobile Home	TUMOB103	—			
	Dummy	—	TU0503BOX			
Antique Brass (05) 	Keyed Entry	TU00105	TU0105KA4	TU0105KA4S	TU0105KA4W	TU0105KA4WK
	Privacy	TU00305	TU0305BOX			
	Passage	TU00405	TU0405BOX			
	Keyed Entry, Twin Set	TU00105T	—			
	Dummy	—	TU0505BOX			
Satin Nickel (15) 	Keyed Entry	TU00115	TU0115KA4	TU0115KA4S	TU0115KA4W	TU0115KA4WK
	Privacy	TU00315	TU0315BOX			
	Passage	TU00415	TU0415BOX			
	Keyed Entry, Twin Set	TU00115T	—			
	Dummy	—	TU0515BOX			

TULIP KNOB COMBO PACKS (TU)

FINISH	DESCRIPTION	RETAIL PACK MASTER CARTON QTY: 2	BOX PACK MASTER CARTON QTY: 4			
			KW1	SC1	WR5	WK2
Polished Brass (03)	Single Cylinder Deadbolt Combo Pack	TUC00603	TUC0603KA4	TUC0603KA4S	TUC0603KA4W	TUC0603KA4WK
	Single Cylinder Deadbolt Combo Pack, Twin Set	TUC00603T	—			
Antique Brass (05)	Single Cylinder Deadbolt Combo Pack	TUC00605	TUC0605KA4	TUC0605KA4S	TUC0605KA4W	TUC0605KA4WK
	Double Cylinder Deadbolt Combo Pack	TUC00705	—			
Satin Nickel (15)	Single Cylinder Deadbolt Combo Pack	TUC00615	TUC0615KA4	TUC0615KA4S	TUC0615KA4W	TUC0615KA4WK
	Double Cylinder Deadbolt Combo Pack	TUC00715	—			

Box Pack product is packaged in KA4 sets with 2 different KA4 sets per Master Carton of 8. Retail Pack product is Keyed Different.

RESIDENTIAL DOOR HARDWARE

GRADE 3 KNOBS

BALL KNOBS (BA)





FINISH	DESCRIPTION	RETAIL PACK MASTER CARTON QTY: 2	BOX PACK MASTER CARTON QTY: 8			
			KW1	SC1	WR5	WK2
Polished Brass (03) 	Keyed Entry	BA00103	—			
	Single Cylinder Deadbolt Combo Pack	BAC0603	—			
	Privacy	BA00303	—			
	Passage	BA00403	—			
	Keyed Entry, Twin Set	BA00103T	—			
Satin Nickel (15) 	Keyed Entry	BA00115	BA0115KA4	BA0115KA4S	BA0115KA4W	BA0115KA4WK
	Privacy	BA00315	BA0315BOX			
	Passage	BA00415	BA0415BOX			
	Keyed Entry, Twin Set	BA00115T	—			
	Storeroom	—	BA0215KA4	BA0215KA4S	—	—

Box Pack product is packaged in KA4 sets with 2 different KA4 sets per Master Carton of 8. Retail Pack product is Keyed Different.

RESIDENTIAL DOOR HARDWARE

GRADE 3 LEVERS

WAVE LEVERS (WL)

FINISH	DESCRIPTION	RETAIL PACK MASTER CARTON QTY: 2	BOX PACK MASTER CARTON QTY: 8			
			KW1	SC1	WR5	WK2
Polished Brass (03) 	Keyed Entry	WL0103D	WL0103KA4	WL0103KA4S	WL0103KA4W	WL0103KA4WK
	Privacy	WL0303D	WL0303BOX			
	Passage	WL0403D	WL0403BOX			
	Dummy (Right-Handed)	—	WLRH0503BOX			
	Dummy (Left-Handed)	—	WLLH0503BOX			
	Storeroom	—	WL0203KA4	WL0203KA4S	—	—
Antique Brass (05) 	Keyed Entry	WL0105D	WL0105KA4	WL0105KA4S	WL0105KA4W	WL0105KA4WK
	Privacy	WL0305D	WL0305BOX			
	Passage	WL0405D	WL0405BOX			
Satin Nickel (15) 	Keyed Entry	WL0115	WL0115KA4	WL0115KA4S	WL0115KA4W	WL0115KA4WK
	Privacy	WL0315	WL0315BOX			
	Passage	WL0415	WL0415BOX			
	Dummy (Right-Handed)	—	WLRH0515BOX			
	Dummy (Left-Handed)	—	WLLH0515BOX			
	Storeroom	—	WL0215KA4	WL0215KA4S	—	—
Aged Bronze (12P) 	Keyed Entry	WL0112P	WL0112PKA4	WL0112PKA4S	WL0112PKA4W	WL0112PKA4WK
	Privacy	WL0312P	WL0312PBOX			
	Passage	WL0412P	WL0412PBOX			
	Dummy (Right-Handed)	—	WLRH0512PBOX			
	Dummy (Left-Handed)	—	WLLH0512PBOX			
	Storeroom	—	WL0212PKA4	WL0212PKA4S	—	—

WAVE LEVER COMBO PACKS (WL)

FINISH	DESCRIPTION	RETAIL PACK MASTER CARTON QTY: 2	BOX PACK MASTER CARTON QTY: 4			
			KW1	SC1	WR5	WK2
Polished Brass (03)	Single Cylinder Deadbolt Combo Pack	WLC0603D	WLC0603KA4	WLC0603KA4S	WLC0603KA4W	WLC0603KA4WK
Antique Brass (05)	Single Cylinder Deadbolt Combo Pack	WLC0605D	—			
Satin Nickel (15)	Single Cylinder Deadbolt Combo Pack	WLC0615D	WLC0615KA4	WLC0615KA4S	WLC0615KA4W	WLC0615KA4WK
Aged Bronze (12P)	Single Cylinder Deadbolt Combo Pack	—	WLC0612PKA4	WLC0612PKA4S	WLC0612PKA4W	WLC0612PKA4WK

Box Pack product is packaged in KA4 sets with 2 different KA4 sets per Master Carton of 8. Retail Pack product is Keyed Different.

RESIDENTIAL DOOR HARDWARE

GRADE 3 LEVER HANDLESETS

WAVE LEVER HANDLESETS (HDLWL)



FINISH	DESCRIPTION	RETAIL PACK MASTER CARTON QTY: 2	BOX PACK MASTER CARTON QTY: 2			
			KW1	SC1	WR5	WK2
Polished Brass (03) 	Single Cylinder Deadbolt with Wave Lever (Left Hand)	—	HDLWLLH0603KA4	HDLWLLH0603KA4S	HDLWLLH0603KA4W	HDLWLLH0603KA4WK
	Single Cylinder Deadbolt with Wave Lever (Right Hand)	—	HDLWLRH0603KA4	HDLWLRH0603KA4S	HDLWLRH0603KA4W	HDLWLRH0603KA4WK
Antique Brass (05) 	Single Cylinder Deadbolt with Wave Lever (Left Hand)	—	HDLWLLH0605KA4	HDLWLLH0605KA4S	HDLWLLH0605KA4W	HDLWLLH0605KA4WK
	Single Cylinder Deadbolt with Wave Lever (Right Hand)	—	HDLWLRH0605KA4	HDLWLRH0605KA4S	HDLWLRH0605KA4W	HDLWLRH0605KA4WK
Satin Nickel (15) 	Single Cylinder Deadbolt with Wave Lever (Left Hand)	—	HDLWLLH0615KA4	HDLWLLH0615KA4S	HDLWLLH0615KA4W	HDLWLLH0615KA4WK
	Single Cylinder Deadbolt with Wave Lever (Right Hand)	—	HDLWLRH0615KA4	HDLWLRH0615KA4S	HDLWLRH0615KA4W	HDLWLRH0615KA4WK
Aged Bronze (12P) 	Single Cylinder Deadbolt with Wave Lever (Left Hand)	—	HDLWLLH0612PKA4	HDLWLLH0612PKA4S	HDLWLLH0612PKA4W	HDLWLLH0612PKA4WK
	Single Cylinder Deadbolt with Wave Lever (Right Hand)	—	HDLWLRH0612PKA4	HDLWLRH0612PKA4S	HDLWLRH0612PKA4W	HDLWLRH0612PKA4WK

Box Pack product is packaged in KA4 sets with 2 different KA4 sets per Master Carton of 8. Retail Pack product is Keyed Different.

RESIDENTIAL DOOR HARDWARE

GRADE 1 LEVERS

RETURN LEVERS (RL)

FINISH	DESCRIPTION	RETAIL PACK MASTER CARTON QTY: 2	BOX PACK MASTER CARTON QTY: 8			
			KW1	SC1	WR5	WK2
Polished Brass (03) 	Keyed Entry	—	RL0103KA4	RL0103KA4S	RL0103KA4W	—
	Privacy	—	RL0303BOX			
	Passage	—	RL0403BOX			
	Dummy	—	RL0503BOX			
	Storeroom	—	RL0203KA4	RL0203KA4S	—	—
Satin Nickel (15) 	Keyed Entry	—	RL0115KA4	RL0115KA4S	RL0115KA4W	—
	Privacy	—	RL0315BOX			
	Passage	—	RL0415BOX			
	Dummy	—	RL0515BOX			
	Storeroom	—	RL0215KA4	RL0215KA4S	—	—
Aged Bronze (12P) 	Keyed Entry	—	RL0112PKA4	RL0112PKA4S	RL0112PKA4W	—
	Privacy	—	RL0312PBOX			
	Passage	—	RL0412PBOX			
	Dummy	—	RL0512PBOX			
	Storeroom	—	RL0212PKA4	RL0212PKA4S	—	—

STRAIGHT LEVERS (SL)





FINISH	DESCRIPTION	RETAIL PACK MASTER CARTON QTY: 2	BOX PACK MASTER CARTON QTY: 8			
			KW1	SC1	WR5	WK2
Polished Brass (03) 	Keyed Entry	SLL0103	SLL0103KA4	SLL0103KA4S	SLL0103KA4W	SLL0103KA4WK
	Privacy	SLL0303	SLL0303BOX			
	Passage	SLL0403	SLL0403BOX			
	Dummy	—	SLL0503BOX			
Satin Nickel (15) 	Keyed Entry	SLL0115	SLL0115KA4	SLL0115KA4S	SLL0115KA4W	SLL0115KA4WK
	Privacy	SLL0315	SLL0315BOX			
	Passage	SLL0415	SLL0415BOX			
	Dummy	—	SLL0515BOX			

Box Pack product is packaged in KA4 sets with 2 different KA4 sets per Master Carton of 8. Retail Pack product is Keyed Different.





RESIDENTIAL DOOR HARDWARE

GRADE 1 DEADBOLTS

GRADE 1 SINGLE CYLINDER DEADBOLTS (DSH)

FINISH	DESCRIPTION	RETAIL PACK MASTER CARTON QTY: 2	BOX PACK MASTER CARTON QTY: 8			
			KW1	SC1	WR5	WK2
Polished Brass (03) 	Single Cylinder Deadbolt	—	DSH0603KA4	DSH0603KA4S	DSH0603KA4W	DSH0603KA4WK
Antique Brass (05) 	Single Cylinder Deadbolt	—	DSH0605KA4	DSH0605KA4S	DSH0605KA4W	DSH0605KA4WK
Satin Nickel (15) 	Single Cylinder Deadbolt	—	DSH0615KA4	DSH0615KA4S	DSH0615KA4W	DSH0615KA4WK
Aged Bronze (12P) 	Single Cylinder Deadbolt	—	DSH0612PKA4	DSH0612PKA4S	DSH0612PKA4W	DSH0612PKA4WK

GRADE 1 DOUBLE CYLINDER DEADBOLTS





Polished Brass (03) 	Double Cylinder Deadbolt	—	DSH0703KA4	DSH0703KA4S	—	—
Antique Brass (05) 	Double Cylinder Deadbolt	—	DSH0705KA4	DSH0705KA4S	—	—
Satin Nickel (15) 	Double Cylinder Deadbolt	—	DSH0715KA4	DSH0715KA4S	—	—
Aged Bronze (12P) 	Double Cylinder Deadbolt	—	DSH0712PKA4	DSH0712PKA4S	—	—

Box Pack product is packaged in KA4 sets with 2 different KA4 sets per Master Carton of 8. Retail Pack product is Keyed Different.

RESIDENTIAL DOOR HARDWARE

GRADE 3 DEADBOLTS

GRADE 3 SINGLE CYLINDER DEADBOLTS (DSO)

FINISH	DESCRIPTION	RETAIL PACK MASTER CARTON QTY: 2	BOX PACK MASTER CARTON QTY: 8			
			KW1	SC1	WR5	WK2
Polished Brass (03) 	Single Cylinder Deadbolt	DS00603	DS0603KA4	DS0603KA4S	DS0603KA4W	DS0603KA4WK
	One Sided Deadbolt (no cylinder)	—	DS0503			
Antique Brass (05) 	Single Cylinder Deadbolt	DS00605	DS0605KA4	DS0605KA4S	DS0605KA4W	DS0605KA4WK
	One Sided Deadbolt (no cylinder)	—	DS0505			
Satin Nickel (15) 	Single Cylinder Deadbolt	DS00615	DS0615KA4	DS0615KA4S	DS0615KA4W	DS0615KA4WK
	One Sided Deadbolt (no cylinder)	—	DS0515			
Aged Bronze (12P) 	Single Cylinder Deadbolt	DS00612P	DS0612PKA4	DS0612PKA4S	DS0612PKA4W	DS0612PKA4WK
	One Sided Deadbolt (no cylinder)	—	DS0512P			

GRADE 3 DOUBLE CYLINDER DEADBOLTS

Polished Brass (03) 	Double Cylinder Deadbolt	DS00703	DS0703KA4	DS0703KA4S	DS0703KA4W	DS0703KA4WK
Antique Brass (05) 	Double Cylinder Deadbolt	DS00705	DS0705KA4	DS0705KA4S	DS0705KA4W	DS0705KA4WK
Satin Nickel (15) 	Double Cylinder Deadbolt	DS00715	DS0715KA4	DS0715KA4S	DS0715KA4W	DS0715KA4WK
Aged Bronze (12P) 	Double Cylinder Deadbolt	DS00712P	DS0712PKA4	DS0712PKA4S	DS0712PKA4W	DS0712PKA4WK

Box Pack product is packaged in KA4 sets with 2 different KA4 sets per Master Carton of 8. Retail Pack product is Keyed Different.

RESIDENTIAL DOOR HARDWARE

KNOB, LEVER & DEADBOLT REPLACEMENT CYLINDERS

REPLACEMENT CYLINDERS

FINISH	BOX PACK MASTER CARTON QTY: 8			
	KW1	SC1	WR5	WK2
GRADE 3 BALL & TULIP KNOB CYLINDERS				
Polished Brass (03)	D125G3BATU03	D045G3BATU03	D135G3BATU03	D335G3BATU03
Satin Nickel (15)	D125G3BATU15	D045G3BATU15	D135G3BATU15	D335G3BATU15
GRADE 3 BISCUIT & RUSK KNOB AND LEVER CYLINDERS				
Polished Brass (03)	D125G3BCLL03	D045G3BCLL03	D135G3BCLL03	D335G3BCLL03
Satin Nickel (15)	D125G3BCLL15	D045G3BCLL15	D135G3BCLL15	D335G3BCLL15
GRADE 3 SINGLE DEADBOLT CYLINDERS				
Polished Brass (03)	D125G3SD03	D045G3SD03	D135G3SD03	D335G3SD03
Antique Brass (05)	D125G3SD05	D045G3SD05	D135G3SD05	D335G3SD05
Satin Nickel (15)	D125G3SD15	D045G3SD15	D135G3SD15	D335G3SD15
Aged Bronze (12P)	D125G3SD12P	D045G3SD12P	D135G3SD12P	D335G3SD12P
GRADE 3 DOUBLE DEADBOLT CYLINDERS				
Polished Brass (03)	D125G3DD03	D045G3DD03	D135G3DD03	D335G3DD03
Antique Brass (05)	D125G3DD05	D045G3DD05	D135G3DD05	D335G3DD05
Satin Nickel (15)	D125G3DD15	D045G3DD15	D135G3DD15	D335G3DD15
Aged Bronze (12P)	D125G3DD12P	D045G3DD12P	D135G3DD12P	D335G3DD12P
GRADE 1 SINGLE DEADBOLT CYLINDERS				
Polished Brass (03)	D125G1SD03	D045G1SD03	D135G1SD03	D335G1SD03
Antique Brass (05)	D125G1SD05	D045G1SD05	D135G1SD05	D335G1SD05
Satin Nickel (15)	D125G1SD15	D045G1SD15	D135G1SD15	D335G1SD15
Aged Bronze (12P)	D125G1SD12P	D045G1SD12P	D135G1SD12P	D335G1SD12P
GRADE 1 DOUBLE DEADBOLT CYLINDERS				
Polished Brass (03)	D125G1DD03	D045G1DD03	—	—
Antique Brass (05)	D125G1DD05	D045G1DD05	—	—
Satin Nickel (15)	D125G1DD15	D045G1DD15	—	—
Aged Bronze (12P)	D125G1DD12P	D045G1DD12P	—	—

RESIDENTIAL DOOR HARDWARE SPECIFICATIONS / DIMENSIONS

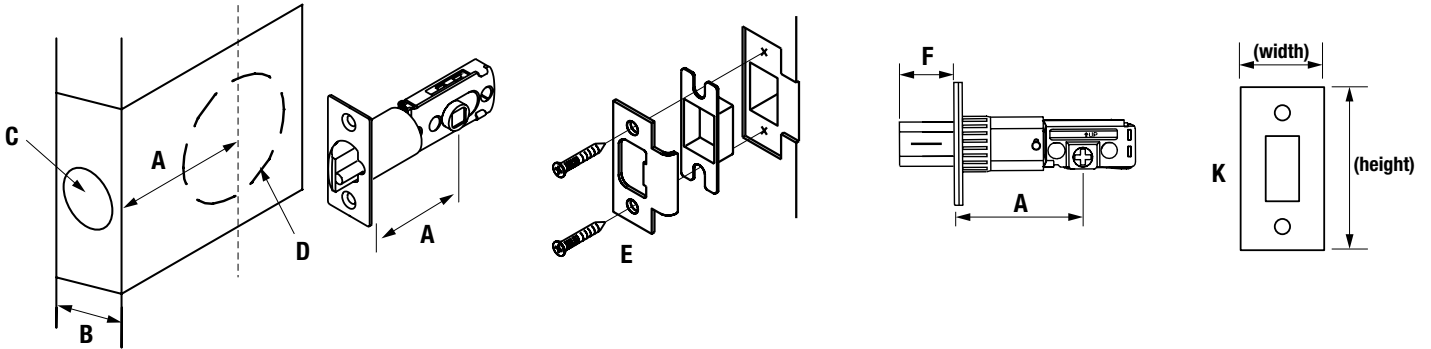

Knobsets

Leversets

Deadbolts

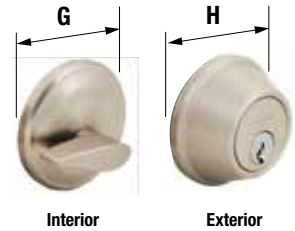
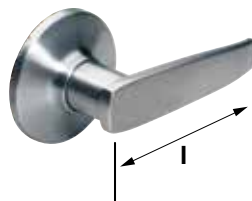
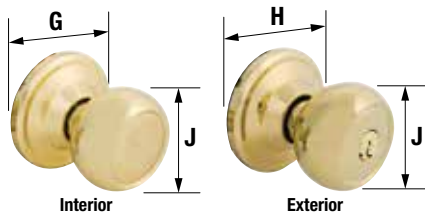

KNOBSETS - GRADE 3

STYLE	PRODUCT	A BACKSET	B FOR DOOR THICKNESS	C EDGE BORE	D CROSSBORE SIZE	E STRIKE (FULL LIP)	F THROW LENGTH	G INTERIOR TRIM DIA.	H EXTERIOR TRIM DIA.	I LEVER LENGTH	J KNOB DIA.	K LATCH FACE DIM. (W X H)
Tulip												
	Keyed Entry	2-3/8" to 2-3/4"	1-3/8" to 1-3/4"	1"	2-1/8"	2-1/4" x 1-3/4"	NA	2-1/2"	2-1/2"	NA	1-7/8"	1" x 2-1/4"
	Privacy											
	Passage											
	Mobile Home											
Ball												
	Keyed Entry	2-3/8" to 2-3/4"	1-3/8" to 1-3/4"	1"	2-1/8"	2-1/4" x 1-3/4"	NA	2-1/2"	2-1/2"	NA	1-7/8"	1" x 2-1/4"
	Privacy											
	Passage											
Biscuit												
	Keyed Entry	2-3/8" to 2-3/4"	1-3/8" to 1-3/4"	1"	2-1/8"	2-1/4" x 1-3/4"	NA	2-1/2"	2-1/2"	NA	1-7/8"	1" x 2-1/4"
	Privacy											
	Passage											
Rusk												
	Keyed Entry	2-3/8" to 2-3/4"	1-3/8" to 1-3/4"	1"	2-1/8"	2-1/4" x 1-3/4"	NA	2-1/2"	2-1/2"	NA	1-7/8"	1" x 2-1/4"
	Privacy											
	Passage											

RESIDENTIAL DOOR HARDWARE

SPECIFICATIONS / DIMENSIONS

LEVERSETS - GRADE 3

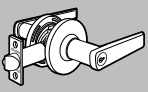
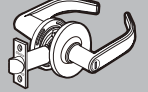
		A	B	C	D	E	F	G	H	I	J	K
STYLE	PRODUCT	BACKSET	FOR DOOR THICKNESS	EDGE BORE	CROSSBORE SIZE	STRIKE (FULL LIP)	THROW LENGTH	INTERIOR TRIM DIA.	EXTERIOR TRIM DIA.	LEVER LENGTH	KNOB DIA.	LATCH FACE DIM. (W X H)
WAVE LEVER												
	Keyed Entry	2-3/8" to 2-3/4"	1-3/8" to 1-3/4"	1"	2-1/8"	2-1/4" x 1-3/4"	NA	2-1/2"	2-1/2"	4-5/8"	NA	1" x 2-1/4"
	Privacy											
	Passage											
STRAIGHT LEVER												
	Keyed Entry	2-3/8" to 2-3/4"	1-3/8" to 1-3/4"	1"	2-1/8"	2-1/4" x 1-3/4"	NA	2-1/2"	2-1/2"	4"	NA	1" x 2-1/4"
	Privacy											
	Passage											
RETURN LEVER												
	Keyed Entry	2-3/8" to 2-3/4"	1-3/8" to 1-3/4"	1"	2-1/8"	2-1/4" x 1-3/4"	NA	2-1/2"	2-1/2"	4"	NA	1" x 2-1/4"
	Privacy											
	Passage											

HANDLESET - GRADE 3

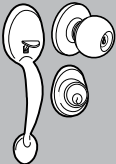
	Keyed Entry/Single Cylinder Deadbolt	2-3/8" to 2-3/4"	1-3/8" to 1-3/4"	1"	2-1/8"	2-1/4" x 1-3/4"	1"	2-1/2"	NA	NA	1-7/8"	1" x 2-1/4"
---	--------------------------------------	------------------	------------------	----	--------	-----------------	----	--------	----	----	--------	-------------

DEADBOLTS - GRADE 3

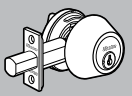
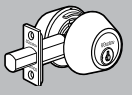
	Single Cylinder Deadbolt	2-3/8" to 2-3/4"	1-3/8" to 1-3/4"	1"	2-1/8"	2-1/4" x 1-3/4"	1"	2-9/16"	2-1/2"	NA	NA	1-3/32" x 2-1/4"
	Double Cylinder Deadbolt	2-3/8" to 2-3/4"	1-3/8" to 1-3/4"	1"	2-1/8"	2-1/4" x 1-3/4"	1"	2-9/16"	2-1/2"	NA	NA	1-3/32" x 2-1/4"

DEADBOLTS - GRADE 1

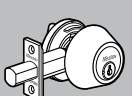
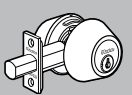
	Single Cylinder Deadbolt	2-3/8" to 2-3/4"	1-3/8" to 1-3/4"	1"	2-1/8"	2-1/4" x 1-3/4"	1"	2-9/16"	2-1/2"	NA	NA	1-3/32" x 2-1/4"
	Double Cylinder Deadbolt	2-3/8" to 2-3/4"	1-3/8" to 1-3/4"	1"	2-1/8"	2-1/4" x 1-3/4"	1"	2-9/16"	2-1/2"	NA	NA	1-3/32" x 2-1/4"



COMMERCIAL DOOR HARDWARE



COMMERCIAL GRADE 2 DOOR HARDWARE



A DEPENDABLE REPLACEMENT FOR ANY BRAND

Master Lock® Grade 2 Commercial Door Hardware provides a cost-effective, dependable replacement for 24 brands of commercial door hardware.

All knobs, deadbolts, and levers feature BumpStop® to resist bump attacks and exceed the ASTM F883-09 test standards for bump resistance. All are available in 24 keyways to support existing keying systems.



Styles

- Standard Duty Ball Knob
- Standard Duty Lever
- Heavy-Duty Lever
- Single Cylinder Deadbolt
- Double Cylinder Deadbolt
- Heavy-Duty Single Cylinder Deadbolt
- Heavy-Duty Double Cylinder Deadbolt

Finishes

- Brushed Chrome
- Oil Rubbed Bronze

Features

- 6-pin Schlage® C compatible cylinder is standard
- Choice of 24 keyways
- Levers meet ADA Standards
- Meets ANSI/BHMA A156.2, Series 4000 standards for entry sets
- Meets ANSI/BHMA A156.5 standards for deadbolts
- UL listed: Meets 3-hour fire rating
- Cylindrical lock housing
- Latch bolt – stainless steel
- Deadbolt – brass with hardened steel roll pin
- Featuring BumpStop® Advanced Cylinder Technology to resist against bumping attacks

Advanced Cylinder Technology



Heavy-Duty Series with These Added Features

Lever

- Clutch feature to resist pry attacks
- Removable thru-bolts
- Large diameter trim ring

Deadbolt

- Heavy die-cast anti-pry collar
- Heavy-duty tie screws
- Adjustable deadbolt latch 2-3/8" – 2-3/4"

COMMERCIAL GRADE 2 DOOR HARDWARE

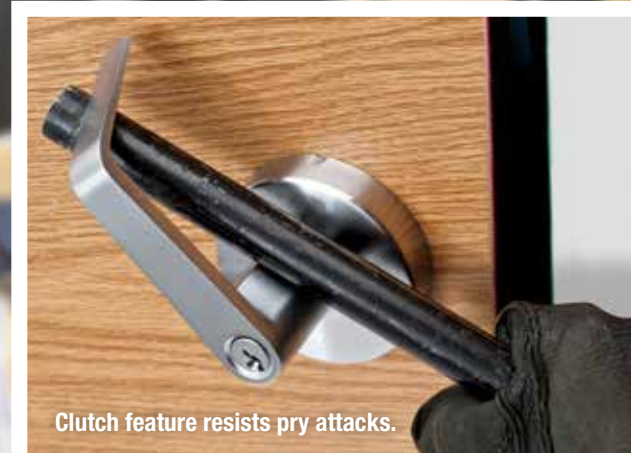

Clutch feature resists pry attacks.

Available in 24 Different Keyways

D10 Arrow® K5, K6, L6A	D01 Corbin® 59A1-A2	D29 Corbin® 60	D07 Corbin® / Russwin® L4	D12 Kwikset® (Composite)	D08 Lockwood®
D70 Sargent® RA-RC (Composite)	D32 Dexter® / Master® 67 (Composite)	D02 Sargent® S	D02 Sargent® U	D04 Schlage® C	D34 Schlage® E
D02 Lori® L200	D80 Lori® Locksmith 80	D90 Loricentric® 90	D11 Russwin® 981/852	D30 Russwin® D1	D36 Sargent® LA-LC (Composite)
D28 Schlage® P (Accepts C-L)	D27 Segal® 9.265	D13 Weiser® (Composite)	D03 Yale® 8	D15 Yale® GA	D02 Harloc® SE-1 (Composite)

16 Small Format Interchangeable Core (SFIC) keyways including Best®, Arrow® & Falcon®

CA	CB	CC	CD
CE	CF	CG	CH
CJ	CK	CL	CM
CQ	CW	CX	CY

CYLINDER	DESCRIPTION	CYLINDER	DESCRIPTION	CYLINDER	DESCRIPTION	CYLINDER	DESCRIPTION
D10	Arrow® K5, K6, L6A	D01	Corbin® 59A1-A2	D29	Corbin® 60	D07	Corbin®/Russwin® L4
D12	Kwikset® (composite)*	D08	Lockwood®	D02	Lori® L200	D80	Lori® Locksmith 80*
D90	Loricentric® 90**	D11	Russwin® 981/852	D30	Russwin® D1	D36	Sargent® LA-LC (composite)
D70	Sargent® RA-RC (composite)	D32	Dexter®/Master® 67 composite)*	D02	Sargent® S	D02	Sargent® U
D04	Schlage® C (Standard)	D34	Schlage® E	D28	Schlage® P (accepts C-L)	D27	Segal® 9.265*
D13	Weiser® (composite)	D03	Yale® 8	D15	Yale® GA	D02	Harloc® SE-1 (composite)*

*Exclusively available as 5-pin cylinder

**Exclusively available as 6-pin cylinder

All marks are registered trademarks of their respective owners

COMMERCIAL DOOR HARDWARE

GRADE 2 DOOR HARDWARE



CYLINDRICAL BALL KNOB (BLC)

FINISH	DESCRIPTION	BOX PACK NUMBER	MASTER CARTON QTY:
Stainless Brushed Chrome (32D) 	Keyed Entry with BumpStop®	BLC0132DKA4	8
	Privacy	BLC0332D	8
	Passage	BLC0432D	8
	Storeroom with BumpStop®	BLC0232DKA4	8
	Classroom with BumpStop®	BLC0932DKA4	8

CYLINDRICAL LEVER (SLC)

Brushed Chrome (26D) 	Keyed Entry with BumpStop®	SLC0126DKA4	8
	Privacy	SLC0326D	8
	Passage	SLC0426D	8
	Storeroom with BumpStop®	SLC0226DKA4	8
	Classroom with BumpStop®	SLC0926DKA4	8



HEAVY-DUTY CYLINDRICAL LEVER (SLC)

Brushed Chrome (26D) 	Keyed Entry with BumpStop®	SLCHKE26D	8
	Privacy	SLCHPV26D	8
	Passage	SLCHPG26D	8
	Storeroom with BumpStop®	SLCHSR26D	8
	Classroom with BumpStop®	SLCHCR26D	8
	Keyed Entry for SFIC without cylinder	SLCICKE26D	8
	Storeroom for SFIC without cylinder	SLCICSR26D	8
	Classroom for SFIC without cylinder	SLCICCR26D	8
Oil Rubbed Bronze (10B) 	Keyed Entry with BumpStop®	SLCHKE10B	8
	Privacy	SLCHPV10B	8
	Passage	SLCHPG10B	8
	Storeroom with BumpStop®	SLCHSR10B	8
	Classroom with BumpStop®	SLCHCR10B	8
	Keyed Entry for SFIC without cylinder	SLCICKE10B	8
	Storeroom for SFIC without cylinder	SLCICSR10B	8
	Classroom for SFIC without cylinder	SLCICCR10B	8

DEADBOLTS (DSC)

Stainless Brushed Chrome (32D) 	Single Cylinder with BumpStop®	DSC0632DKA4	8
	Double Cylinder with BumpStop®	DSC0732DKA4	8
	One-Sided Cylinder	DSC0532D	8

HEAVY-DUTY DEADBOLTS (DSC)

Stainless Brushed Chrome (32D) 	Single Cylinder with BumpStop®	DSCHSD32D	8
	Double Cylinder with BumpStop®	DSCHDD32D	8
	Single Cylinder for SFIC without cylinder	DSCICSD32D	8
	Double Cylinder for SFIC without cylinder	DSCICDD32D	8
Oil Rubbed Bronze (10B) 	Single Cylinder with BumpStop®	DSCHSD10B	8
	Double Cylinder with BumpStop®	DSCHDD10B	8
	Single Cylinder for SFIC without cylinder	DSCICSD10B	8
	Double Cylinder for SFIC without cylinder	DSCICDD10D	8

COMMERCIAL DOOR HARDWARE



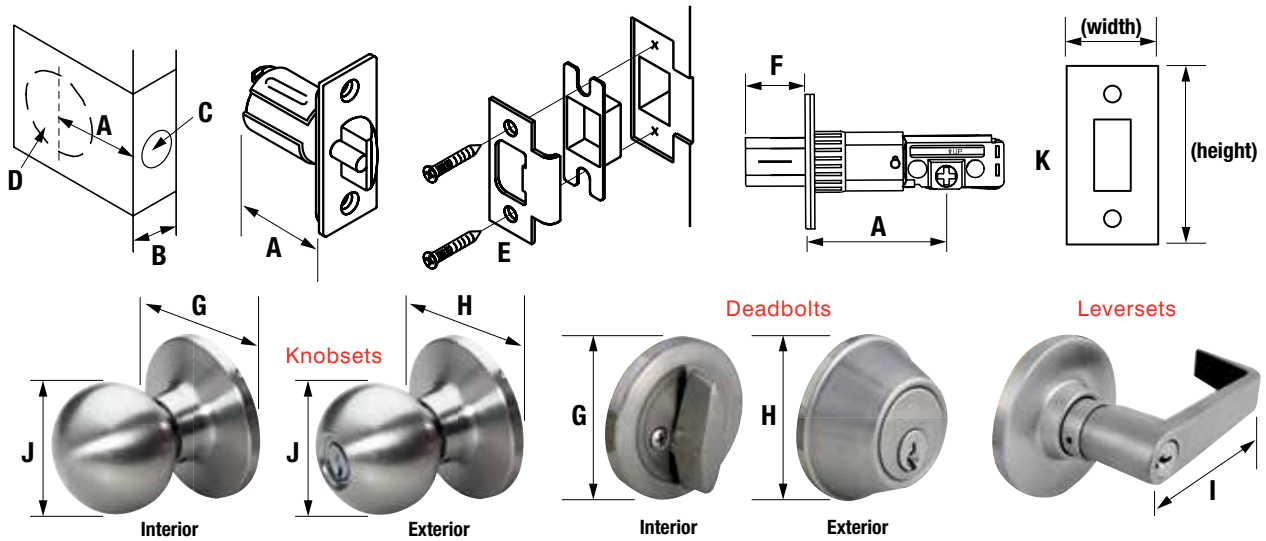

SPECIFICATIONS / DIMENSIONS



PART #	PRODUCT	A	B	C	D	E	F	G	H	I	J	K
		BACKSET	FOR DOOR THICKNESS	EDGE BORE	CROSSBORE SIZE	STRIKE	THROW LENGTH	INTERIOR TRIM DIA.	EXTERIOR TRIM DIA.	LEVER LENGTH	KNOB DIA.	LATCH FACE DIM. (W X H)
CYLINDRICAL BALL KNOB												
	Keyed Entry	2-3/4"	1-3/8" to 1-3/4"	1"	2-1/8"	2-3/4" x 1-1/8" T	NA	3"	3"	NA	2"	1-1/8" x 2-1/4"
	Privacy											
	Passage											
	Storeroom											
	Classroom											
CYLINDRICAL LEVER												
	Keyed Entry	2-3/4"	1-3/8" to 1-3/4"	1"	2-1/8"	2-3/4" x 1-1/8" T	NA	3"	3"	4" with 2" return	NA	1-1/8" x 2-1/4"
	Privacy											
	Passage											
	Storeroom											
	Classroom											
HEAVY-DUTY CYLINDRICAL LEVER												
	Keyed Entry	2-3/4"	1-3/8" to 1-3/4"	1"	2-1/8"	4-7/8 x 1-7/8" T	NA	3-1/4"	3-1/4"	4" with 2-1/2" return	NA	1-1/8" x 2-1/4"
	Privacy											
	Passage											
	Storeroom											
	Classroom											
DEADBOLTS												
	Single Cylinder Deadbolt	2-3/4"	1-3/8" to 1-3/4"	1"	2-1/8"	2-3/4" x 1-1/8" T	1"	2-9/16"	NA	NA	NA	1-1/8" x 2-1/4"
	Double Cylinder Deadbolt											
	One-Sided Cylinder Deadbolt											
HEAVY-DUTY DEADBOLTS												
	Single Cylinder Deadbolt	2-3/4"	1-3/8" to 1-3/4"	1"	2-1/8"	2-3/4" x 1-1/8" T	1"	2-9/16"	NA	NA	NA	1-1/8" x 2-1/4"
	Double Cylinder Deadbolt											

MERCHANDISING

DEMO/DISPLAY MOUNTS

PRODUCT	PART NUMBER	DESCRIPTION
 1402CDSPL	1402CDSPL	2 Hole Mount – Black 2-3/4" Backset
 1402RDSPL	1402RDSPL	2 Hole Mount – Cherry 2-3/8" Backset
 1402EDSPL	1402EDSPL	1 Hole Mount – Cherry 2-3/8" Backset
 1402HDLDSPL	1402HDLDSPL	2 Hole Handle Set Mount – Cherry 2-3/8" Backset
 1404DHDSPL	1404DHDSPL	Acrylic Door Hardware Demo Mount

Contact your Master Lock distributor for more information on these proven merchandising products.



Effective November 15, 2019



Door Hardware

**Master
Lock**

CONTENTS

RESIDENTIAL DOOR HARDWARE

Knobs, Levers and Handlesets

- Biscuit Knobs (BC)4
- Biscuit Knobs Combo Packs (BC)4
- Rusk Knobs (RU).....5
- Ball Knobs (BA)5
- Tulip Knobs (TU).....6
- Tulip Knobs Combo Packs (TU).....6
- Wave Levers (WL)7
- Wave Levers Combo Packs (WL)7
- Return Levers (RL)8
- Straight Levers (SL).....8
- Biscuit Knob Handlesets (HDLBC).....9
- Wave Lever Handlesets (HDLWL)9

Deadbolts

- Grade 3 Single Cylinder (DSO)10
- Grade 3 Double Cylinder (DSO).....10
- Grade 1 Single Cylinder (DSH).....11
- Grade 1 Double Cylinder (DSH).....11

Replacement Cylinders

- Knob, Lever & Deadbolt Cylinders.....12
- Key Blanks.....12

COMMERCIAL DOOR HARDWARE

Grade 2 Door Hardware

- Heavy-Duty Cylindrical Lever (SLC)13
- Cylindrical Lever13
- Cylindrical Ball Knob13
- Heavy-Duty Deadbolts13
- Deadbolts (DSC)13

Small Format Interchangeable Core (SFIC)

- Interchangeable Core14



BC

BISCUIT KNOBS (BC)

FINISH	DESCRIPTION	RETAIL PACK MASTER CARTON QTY: 2	BOX PACK MASTER CARTON QTY: 8			
			KW1	SC1	WR5	WK2
Polished Brass (03)	Keyed Entry	BC00103	BC0103KA4	BC0103KA4S	BC0103KA4W	BC0103KA4WK
	Privacy	BC00303	BC0303BOX			
	Passage	BC00403	BC0403BOX			
	Dummy	—	BC0503BOX			
	Storeroom	—	BC0203KA4	BC0203KA4S	—	—
Antique Brass (05)	Keyed Entry	BC00105	BC0105KA4	BC0105KA4S	BC0105KA4W	BC0105KA4WK
	Privacy	BC00305	BC0305BOX			
	Passage	BC00405	BC0405BOX			
Satin Nickel (15)	Keyed Entry	BC00115	BC0115KA4	BC0115KA4S	BC0115KA4W	BC0115KA4WK
	Privacy	BC00315	BC0315BOX			
	Passage	BC00415	BC0415BOX			
	Dummy	—	BC0515BOX			
	Storeroom	—	BC0215KA4	BC0215KA4S	—	—
Aged Bronze (12P)	Keyed Entry	BC00112P	BC0112PKA4	BC0112PKA4S	BC0112PKA4W	BC0112PKA4WK
	Privacy	BC00312P	BC0312PBOX			
	Passage	BC00412P	BC0412PBOX			
	Dummy	—	BC0512PBOX			
	Storeroom	—	BC0212PKA4	BC0212PKA4S	—	—
Biscuit Knob Combo Packs (BC)		QTY: 2	QTY: 4			
Polished Brass (03)	Single Cylinder Deadbolt Combo Pack	—	BCC0603KA4	BCC0603KA4S	—	—
Antique Brass (05)	Single Cylinder Deadbolt Combo Pack	BCC00605	BCC0605KA4	BCC0605KA4S	—	—
Satin Nickel (15)	Single Cylinder Deadbolt Combo Pack	BCC00615	BCC0615KA4	BCC0615KA4S	—	—
Aged Bronze (12P)	Single Cylinder Deadbolt Combo Pack	BCC00612P	BCC0612PKA4	BCC0612PKA4S	—	—

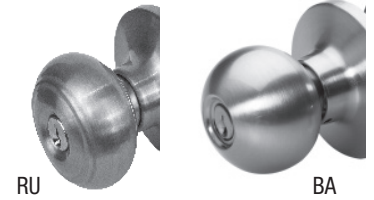

RUSK KNOBS (RU)

FINISH	DESCRIPTION	RETAIL PACK MASTER CARTON QTY: 2	BOX PACK MASTER CARTON QTY: 8			
			KW1	SC1	WR5	WK2
Polished Brass (03)	Keyed Entry	—	RU0103KA4	RU0103KA4S	RU0103KA4W	—
	Privacy	—	RU0303BOX			
	Passage	—	RU0403BOX			
	Dummy	—	RU0503BOX			
	Storeroom	—	RU0203KA4	RU0203KA4S	—	—
Antique Brass (05)	Keyed Entry	—	RU0105KA4	RU0105KA4S	RU0105KA4W	—
	Privacy	—	RU0305BOX			
	Passage	—	RU0405BOX			
	Dummy	—	RU0505BOX			
	Storeroom	—	RU0205KA4	RU0205KA4S	—	—
Satin Nickel (15)	Keyed Entry	—	RU0115KA4	RU0115KA4S	RU0115KA4W	—
	Privacy	—	RU0315BOX			
	Passage	—	RU0415BOX			
	Dummy	—	RU0515BOX			
	Storeroom	—	RU0215KA4	RU0215KA4S	—	—
Aged Bronze (12P)	Keyed Entry	—	RU0112PKA4	RU0112PKA4S	RU0112PKA4W	—
	Privacy	—	RU0312PBOX			
	Passage	—	RU0412PBOX			
	Dummy	—	RU0512PBOX			
	Storeroom	—	RU0212PKA4	RU0212PKA4S	—	—

BALL KNOBS (BA)

FINISH	DESCRIPTION	RETAIL PACK MASTER CARTON QTY: 2	BOX PACK MASTER CARTON QTY: 8			
			KW1	SC1	WR5	WK2
Polished Brass (03)	Keyed Entry	BA00103	—			
	Single Cylinder Deadbolt Combo Pack	BAC0603	—			
	Privacy	BA00303	—			
	Keyed Entry, Twin Set	BA00103T	—			
Satin Nickel (15)	Keyed Entry	BA00115	BA0115KA4	BA0115KA4S	BA0115KA4W	BA0115KA4WK
	Privacy	BA00315	BA0315BOX			
	Passage	BA00415	BA0415BOX			
	Keyed Entry, Twin Set	BA00115T	—			
	Storeroom	—	BA0215KA4	BA0215KA4S	—	—



TULIP KNOBS (TU)

FINISH	DESCRIPTION	RETAIL PACK MASTER CARTON QTY: 2	BOX PACK MASTER CARTON QTY: 8			
			KW1	SC1	WR5	WK2
Polished Brass (03)	Keyed Entry	TU00103	TU0103KA4	TU0103KA4S	TU0103KA4W	TU0103KA4WK
	Single Cylinder Deadbolt Twin Pack	TUC00603T	—			
	Privacy	TU00303	TU0303BOX			
	Passage	TU00403	TU0403BOX			
	Keyed Entry, Twin Set	TU00103T	—			
	Keyed Entry, Mobile Home	TUMOB103	—			
	Dummy	—	TU0503BOX			
Antique Brass (05)	Keyed Entry	TU00105	TU0105KA4	TU0105KA4S	TU0105KA4W	TU0105KA4WK
	Single Cylinder Deadbolt Twin Pack	TUC00705	—			
	Privacy	TU00305	TU0305BOX			
	Passage	TU00405	TU0405BOX			
	Keyed Entry, Twin Set	TU00105T	—			
Satin Nickel (15)	Keyed Entry	TU00115	TU0115KA4	TU0115KA4S	TU0115KA4W	TU0115KA4WK
	Privacy	TU00315	TU0315BOX			
	Passage	TU00415	TU0415BOX			
	Keyed Entry, Twin Set	TU00115T	—			
	Dummy	—	TU0515BOX			
Tulip Knob Combo Packs (TU)		QTY: 2	QTY: 4			
Polished Brass (03)	Single Cylinder Deadbolt Combo Pack	TUC00603	TUC0603KA4	TUC0603KA4S	—	—
Antique Brass (05)	Single Cylinder Deadbolt Combo Pack	TUC00605	—	—	—	—
Satin Nickel (15)	Single Cylinder Deadbolt Combo Pack	TUC00615	—	—	—	—
	Double Cylinder Deadbolt Combo Pack	TUC00715	—	—	—	—



WAVE LEVERS (WL)

FINISH	DESCRIPTION	RETAIL PACK MASTER CARTON QTY: 2	BOX PACK MASTER CARTON QTY: 8				
			KW1	SC1	WR5	WK2	
Polished Brass (03)	Keyed Entry	WL0103D	WL0103KA4	WL0103KA4S	WL0103KA4W	WL0103KA4WK	
	Privacy	WL0303D	WL0303BOX				
	Passage	WL0403D	WL0403BOX				
	Dummy (Right-Handed)	—	WLRH0503BOX				
	Dummy (Left-Handed)	—	WLLH0503BOX				
	Storeroom	—	WL0203KA4	WL0203KA4S	—	—	
Antique Brass (05)	Keyed Entry	WL0105D	WL0105KA4	WL0105KA4S	WL0105KA4W	WL0105KA4WK	
	Privacy	WL0305D	WL0305BOX				
	Passage	—	WL0405BOX				
Satin Nickel (15)	Keyed Entry	WL0115	WL0115KA4	WL0115KA4S	WL0115KA4W	WL0115KA4WK	
	Privacy	WL0315	WL0315BOX				
	Passage	WL0415	WL0415BOX				
	Dummy (Right-Handed)	—	WLRH0515BOX				
	Dummy (Left-Handed)	—	WLLH0515BOX				
	Storeroom	—	WL0215KA4	WL0215KA4S	—	—	
Aged Bronze (12P)	Keyed Entry	WL0112P	WL0112PKA4	WL0112PKA4S	WL0112PKA4W	WL0112PKA4WK	
	Privacy	WL0312P	WL0312PBOX				
	Passage	WL0412P	WL0412PBOX				
	Dummy (Right-Handed)	—	WLRH0512PBOX				
	Dummy (Left-Handed)	—	WLLH0512PBOX				
	Storeroom	—	WL0212PKA4	WL0212PKA4S	—	—	
Wave Lever Combo Packs (WL)		QTY: 2	QTY: 4				
Polished Brass (03)	Single Cylinder Deadbolt Combo Pack	WLC0603D	WLC0603KA4	WLC0603KA4S	WLC0603KA4W	—	
Antique Brass (05)	Single Cylinder Deadbolt Combo Pack	WLC0605D	—				
Satin Nickel (15)	Single Cylinder Deadbolt Combo Pack	WLC0615D	WLC0615KA4	WLC0615KA4S	—	—	
Aged Bronze (12P)	Single Cylinder Deadbolt Combo Pack	—	WLC0612PKA4	WLC0612PKA4S	WLC0612PKA4W	—	

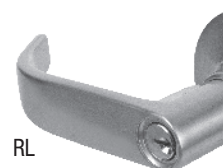

RL

RETURN LEVERS (RL)

FINISH	DESCRIPTION	RETAIL PACK MASTER CARTON QTY: 2	BOX PACK MASTER CARTON QTY: 8			
			KW1	SC1	WR5	WK2
Polished Brass (03)	Keyed Entry	—	RL0103KA4	RL0103KA4S	RL0103KA4W	—
	Privacy	—	RL0303BOX			
	Passage	—	RL0403BOX			
	Dummy	—	RL0503BOX			
	Storeroom	—	RL0203KA4	RL0203KA4S	—	—
Satin Nickel (15)	Keyed Entry	—	RL0115KA4	RL0115KA4S	RL0115KA4W	—
	Privacy	—	RL0315BOX			
	Passage	—	RL0415BOX			
	Dummy	—	RL0515BOX			
	Storeroom	—	RL0215KA4	RL0215KA4S	—	—
Aged Bronze (12P)	Keyed Entry	—	RL0112PKA4	RL0112PKA4S	RL0112PKA4W	—
	Privacy	—	RL0312PBOX			
	Passage	—	RL0412PBOX			
	Dummy	—	RL0512PBOX			
	Storeroom	—	RL0212PKA4	RL0212PKA4S	—	—



SL

STRAIGHT LEVERS (SL)

FINISH	DESCRIPTION	RETAIL PACK MASTER CARTON QTY: 2	BOX PACK MASTER CARTON QTY: 8			
			KW1	SC1	WR5	WK2
Polished Brass (03)	Keyed Entry	SLL0103	SLL0103KA4	SLL0103KA4S	SLL0103KA4W	SLL0103KA4WK
	Privacy	SLL0303	SLL0303BOX			
	Passage	SLL0403	SLL0403BOX			
	Dummy	—	SLL0503BOX			
Satin Nickel (15)	Keyed Entry	SLL0115	SLL0115KA4	SLL0115KA4S	—	—
	Privacy	SLL0315	SLL0315BOX			
	Passage	SLL0415	SLL0415BOX			
	Dummy	—	SLL0515BOX			



BISCUIT KNOBS HANDLESETS (HDLBC)

FINISH	DESCRIPTION	RETAIL PACK MASTER CARTON QTY: 2	BOX PACK MASTER CARTON QTY: 2			
			KW1	SC1	WR5	WK2
Polished Brass (03)	Single Cylinder Deadbolt with Biscuit Knob	HDLBC0603	HDLBC0603KA4	HDLBC0603KA4S	HDLBC0603KA4W	HDLBC0603KA4WK
Antique Brass (05)	Single Cylinder Deadbolt with Biscuit Knob	HDLBC0605	HDLBC0605KA4	HDLBC0605KA4S	HDLBC0605KA4W	HDLBC0605KA4WK
Satin Nickel (15)	Single Cylinder Deadbolt with Biscuit Knob	HDLBC0615	HDLBC0615KA4	HDLBC0615KA4S	HDLBC0615KA4W	HDLBC0615KA4WK
Aged Bronze (12P)	Single Cylinder Deadbolt with Biscuit Knob	HDLBC0612P	HDLBC0612PKA4	HDLBC0612PKA4S	HDLBC0612PKA4W	HDLBC0612PKA4WK



WAVE LEVER HANDLESETS (HDLWL)

FINISH	DESCRIPTION	RETAIL PACK MASTER CARTON QTY: 2	BOX PACK MASTER CARTON QTY: 2			
			KW1	SC1	WR5	WK2
Polished Brass (03)	Single Cylinder Deadbolt with Wave Lever (Left Hand)	—	HDLWLLH0603KA4	HDLWLLH0603KA4S	HDLWLLH0603KA4W	HDLWLLH0603KA4WK
	Single Cylinder Deadbolt with Wave Lever (Right Hand)	—	HDLWLRH0603KA4	HDLWLRH0603KA4S	HDLWLRH0603KA4W	HDLWLRH0603KA4WK
Antique Brass (05)	Single Cylinder Deadbolt with Wave Lever (Left Hand)	—	HDLWLLH0605KA4	HDLWLLH0605KA4S	HDLWLLH0605KA4W	HDLWLLH0605KA4WK
	Single Cylinder Deadbolt with Wave Lever (Right Hand)	—	HDLWLRH0605KA4	HDLWLRH0605KA4S	HDLWLRH0605KA4W	HDLWLRH0605KA4WK
Satin Nickel (15)	Single Cylinder Deadbolt with Wave Lever (Left Hand)	—	HDLWLLH0615KA4	HDLWLLH0615KA4S	HDLWLLH0615KA4W	HDLWLLH0615KA4WK
	Single Cylinder Deadbolt with Wave Lever (Right Hand)	—	HDLWLRH0615KA4	HDLWLRH0615KA4S	HDLWLRH0615KA4W	HDLWLRH0615KA4WK
Aged Bronze (12P)	Single Cylinder Deadbolt with Wave Lever (Left Hand)	—	HDLWLLH0612PKA4	HDLWLLH0612PKA4S	HDLWLLH0612PKA4W	HDLWLLH0612PKA4WK
	Single Cylinder Deadbolt with Wave Lever (Right Hand)	—	HDLWLRH0612PKA4	HDLWLRH0612PKA4S	HDLWLRH0612PKA4W	HDLWLRH0612PKA4WK



DSO

GRADE 3 CYLINDER DEADBOLTS (DSO)

FINISH	DESCRIPTION	RETAIL PACK MASTER CARTON QTY: 2	BOX PACK MASTER CARTON QTY: 8			
			KW1	SC1	WR5	WK2
Single Cylinder						
Polished Brass (03)	Single Cylinder Deadbolt	DS00603	DS0603KA4	DS0603KA4S	DS0603KA4W	DS0603KA4WK
	One Sided Deadbolt (no cylinder)	—	DS0503			
Antique Brass (05)	Single Cylinder Deadbolt	DS00605	DS0605KA4	DS0605KA4S	DS0605KA4W	DS0605KA4WK
	One Sided Deadbolt (no cylinder)	—	DS0505			
Satin Nickel (15)	Single Cylinder Deadbolt	DS00615	DS0615KA4	DS0615KA4S	DS0615KA4W	DS0615KA4WK
	One Sided Deadbolt (no cylinder)	—	DS0515			
Aged Bronze (12P)	Single Cylinder Deadbolt	DS00612P	DS0612PKA4	DS0612PKA4S	DS0612PKA4W	DS0612PKA4WK
	One Sided Deadbolt (no cylinder)	—	DS0512P			
Double Cylinder						
Polished Brass (03)	Double Cylinder Deadbolt	DS00703	DS0703KA4	DS0703KA4S	DS0703KA4W	DS0703KA4WK
Antique Brass (05)	Double Cylinder Deadbolt	DS00705	DS0705KA4	DS0705KA4S	DS0705KA4W	DS0705KA4WK
Satin Nickel (15)	Double Cylinder Deadbolt	DS00715	DS0715KA4	DS0715KA4S	DS0715KA4W	DS0715KA4WK
Aged Bronze (12P)	Double Cylinder Deadbolt	DS00712P	DS0712PKA4	DS0712PKA4S	DS0712PKA4W	DS0712PKA4WK



DSH

GRADE 1 CYLINDER DEADBOLTS (DSH)

FINISH	DESCRIPTION	RETAIL PACK MASTER CARTON QTY: 2	BOX PACK MASTER CARTON QTY: 8			
			KW1	SC1	WR5	WK2
Single Cylinder						
Polished Brass (03)	Single Cylinder Deadbolt	—	DSH0603KA4	DSH0603KA4S	DSH0603KA4W	DSH0603KA4WK
Antique Brass (05)	Single Cylinder Deadbolt	—	DSH0605KA4	DSH0605KA4S	DSH0605KA4W	DSH0605KA4WK
Satin Nickel (15)	Single Cylinder Deadbolt	—	DSH0615KA4	DSH0615KA4S	DSH0615KA4W	DSH0615KA4WK
Aged Bronze (12P)	Single Cylinder Deadbolt	—	DSH0612PKA4	DSH0612PKA4S	DSH0612PKA4W	DSH0612PKA4WK
Double Cylinder						
Polished Brass (03)	Double Cylinder Deadbolt	—	DSH0703KA4	DSH0703KA4S	—	—
Antique Brass (05)	Double Cylinder Deadbolt	—	DSH0705KA4	DSH0705KA4S	—	—
Satin Nickel (15)	Double Cylinder Deadbolt	—	DSH0715KA4	DSH0715KA4S	—	—
Aged Bronze (12P)	Double Cylinder Deadbolt	—	DSH0712PKA4	DSH0712PKA4S	—	—

REPLACEMENT CYLINDERS & KEY BLANKS

FINISH	BOX PACK MASTER CARTON QTY: 8			
	KW1	SC1	WR5	WK2
GRADE 3 BALL & TULIP KNOB CYLINDERS				
Polished Brass (03)	D125G3BATU03	D045G3BATU03	D135G3BATU03	D335G3BATU03
Satin Nickel (15)	D125G3BATU15	D045G3BATU15	D135G3BATU15	D335G3BATU15
GRADE 3 BISCUIT AND RUSK KNOB & LEVER CYLINDERS				
Polished Brass (03)	D125G3BCLL03	D045G3BCLL03	D135G3BCLL03	D335G3BCLL03
Satin Nickel (15)	D125G3BCLL15	D045G3BCLL15	D135G3BCLL15	D335G3BCLL15
GRADE 3 SINGLE DEADBOLT CYLINDERS				
Polished Brass (03)	D125G3SD03	D045G3SD03	D135G3SD03	D335G3SD03
Antique Brass (05)	D125G3SD05	D045G3SD05	D135G3SD05	D335G3SD05
Satin Nickel (15)	D125G3SD15	D045G3SD15	D135G3SD15	D335G3SD15
Aged Bronze (12P)	D125G3SD12P	D045G3SD12P	D135G3SD12P	D335G3SD12P
GRADE 3 DOUBLE DEADBOLT CYLINDERS				
Polished Brass (03)	D125G3DD03	D045G3DD03	D135G3DD03	D335G3DD03
Antique Brass (05)	D125G3DD05	D045G3DD05	D135G3DD05	D335G3DD05
Satin Nickel (15)	D125G3DD15	D045G3DD15	D135G3DD15	D335G3DD15
Aged Bronze (12P)	D125G3DD12P	D045G3DD12P	D135G3DD12P	D335G3DD12P
GRADE 1 SINGLE DEADBOLT CYLINDERS				
Polished Brass (03)	D125G1SD03	D045G1SD03	D135G1SD03	D335G1SD03
Antique Brass (05)	D125G1SD05	D045G1SD05	D135G1SD05	D335G1SD05
Satin Nickel (15)	D125G1SD15	D045G1SD15	D135G1SD15	D335G1SD15
Aged Bronze (12P)	D125G1SD12P	D045G1SD12P	D135G1SD12P	D335G1SD12P
GRADE 1 DOUBLE DEADBOLT CYLINDERS				
Polished Brass (03)	D125G1DD03	D045G1DD03	—	—
Antique Brass (05)	D125G1DD05	D045G1DD05	—	—
Satin Nickel (15)	D125G1DD15	D045G1DD15	—	—
Aged Bronze (12P)	D125G1DD12P	D045G1DD12P	—	—
KEY BLANKS				
	BOX PACK MASTER CARTON QTY: 25			
K2245	KW1 Key Blank			
K2246	SC1 Key Blank			
K2247	WR3/51 Key Blank			
K2248	WK2 Key Blank			

LEVER, KNOB & DEADBOLTS

FINISH	DESCRIPTION	PART NUMBER	MASTER CARTON QTY:
HEAVY-DUTY CYLINDRICAL LEVER (SLC)			
Brushed Chrome (26D) 	Keyed Entry with BumpStop® – ASA Strike	SLCHKE26D	8
	Privacy	SLCHPV26D	8
	Passage	SLCHPG26D	8
	Storeroom with BumpStop® – ASA Strike	SLCHSR26D	8
	Classroom with BumpStop® – ASA Strike	SLCHCR26D	8
	Keyed Entry for SFIC without cylinder	SLCICKE26D	8
	Storeroom for SFIC without cylinder – ASA Strike	SLCICSR26D	8
	Classroom for SFIC without cylinder – ASA Strike	SLCICCR26D	8
Oil Rubbed Bronze (10B) 	Keyed Entry with BumpStop® – ASA Strike	SLCHKE10B	8
	Privacy	SLCHPV10B	8
	Passage	SLCHPG10B	8
	Storeroom with BumpStop® – ASA Strike	SLCHSR10B	8
	Classroom with BumpStop® – ASA Strike	SLCHCR10B	8
	Keyed Entry for SFIC without cylinder – ASA Strike	SLCICKE10B	8
	Storeroom for SFIC without cylinder – ASA Strike	SLCICSR10B	8
	Classroom for SFIC without cylinder – ASA Strike	SLCICCR10B	8
CYLINDRICAL LEVER (SLC)			
Brushed Chrome (26D) 	Keyed Entry with BumpStop®	SLC0126DKA4	8
	Privacy	SLC0326D	8
	Passage	SLC0426D	8
	Storeroom with BumpStop®	SLC0226DKA4	8
	Classroom with BumpStop®	SLC0926DKA4	8
CYLINDRICAL BALL KNOB (BLC)			
Stainless Brushed Chrome (32D) 	Keyed Entry with BumpStop®	BLC0132DKA4	8
	Privacy	BLC0332D	8
	Passage	BLC0432D	8
	Storeroom with BumpStop®	BLC0232DKA4	8
	Classroom with BumpStop®	BLC0932DKA4	8
HEAVY-DUTY DEADBOLTS (DSC)			
Stainless Brushed Chrome (32D) 	Single Cylinder with BumpStop® – ASA Strike	DSCHSD32D	8
	Double Cylinder with BumpStop® – ASA Strike	DSCHDD32D	8
	Single Cylinder for SFIC without cylinder – ASA Strike	DSCICSD32D	8
	Double Cylinder for SFIC without cylinder – ASA Strike	DSCICDD32D	8
Oil Rubbed Bronze (10B) 	Single Cylinder with BumpStop® – ASA Strike	DSCHSD10B	8
	Double Cylinder with BumpStop® – ASA Strike	DSCHDD10B	8
	Single Cylinder for SFIC without cylinder – ASA Strike	DSCICSD10B	8
	Double Cylinder for SFIC without cylinder – ASA Strike	DSCICDD10B	8
DEADBOLTS (DSC)			
Stainless Brushed Chrome (32D) 	Single Cylinder with BumpStop® – ASA Strike	DSC0632DKA4	8
	Double Cylinder with BumpStop® – ASA Strike	DSC0732DKA4	8
	One-Sided Cylinder	DSC0532D	8

Commercial Grade 2 Door Hardware | Cylinders and Cores

EXAMPLE	DSCHSD32D (Schlage D046 default keyway)
	DSCHDS32D D12 KA 4KEY
	SLCICKE10B CY

Cylinder	Description
D12	Kwikset® (composite)*
D04	Schlage® C (Standard)
D03	Yale® 8

*Exclusively available as 5-pin cylinder **Exclusively available as 6-pin cylinder

Core	REQUIRED CHOICE
CY	Standard SFIC Keyway

Number of Pins	Standard: 5 Pin
6	6 Pins (<i>Except Standard Models with Schlage® C 6 Pin cylinders –D046 option</i>)
7	7 Pins (<i>SFIC only</i>)

Keying	Standard: Keyed Different
KA	Keyed Alike
MK	Keyed Different; Master Keyed
KAMK	Keyed Alike; Master Keyed

Number of Keys	Standard: 2 Keys per Lock
1KEY	1 key per lock
3KEY	3 keys per lock
4KEY	4 keys per lock
NOKEY	0 keys per lock

All marks are registered trademarks of their respective owners.

**Master
Lock®**

**AMERICAN
LOCK®**









END-TO-END SAFETY SOLUTIONS



LOCKOUT PADLOCKS | LOCKOUT DEVICES | LOCKOUT SERVICES

Table of Contents

Padlocks, Identification, & Accessories

	Zenex™ Thermoplastic Safety Padlocks	P6-8
	Safety Padlock Keyed-Alike Sets	P9
	Aluminum Safety Padlocks	P10-11
	Steel Safety Padlocks	P12
	Padlock Identification	P13
	Padlock Accessories	P14





Lockout Devices

	Hasps	P15
	Electrical Lockouts	P16-18
	Valve Lockouts	P19-20
	Cable Lockouts	P21
	Group Lock Boxes	P22-23
	Permit Control Station	P24
	Blind Flange & Pneumatic Lockouts	P25



Lockout Devices (continued)

	Electrical Covers	P26-27
---	-----------------------------	--------

Lockout Kits & Stations

	Lockout Kits	P28-29
	Padlock Stations	P30
	Compact Stations	P31
	Lockout Stations	P32-33



Signs & Tags

	Safety Tags	P34-35
	Guardian Extreme™ Safety Tags	P36

Planograms

	Safety Lockout Planograms	P37
---	-------------------------------------	-----

Professional Services & Software

	Professional Lockout Services	P38
	Lockout Procedure Writing Software	P39

Lockout/Tagout & OSHA Compliance

What is Lockout/Tagout?

In 1989, OSHA introduced Standard 29 CFR 1910.147 *The Control of Hazardous Energy* in order to establish lockout tagout compliance requirements for general industry. Lockout/Tagout is the process of controlling hazardous energy during the service and maintenance of machinery and equipment. These safety specific work procedures safeguard employees from accidental injuries or even death.

Why Lockout/Tagout?

The Control of Hazardous Energy (lockout/tagout) has been listed within OSHA's top 10 most frequently cited standards for several years. Non-compliance with this standard has resulted in thousands of worker related injuries and even deaths. Lockout/Tagout procedures are utilized to protect employees from the dangers of hazardous energy and ensure they go home safely every day.

Master Lock offers the safety products and services you need to help you stay compliant

How to Implement a Lockout/Tagout System



The 1910.147 standard stated above establishes requirements for facilities to implement and employees to follow. In order to keep employees safe and to comply with the OSHA standard, facilities must:

- + **Develop** – create a lockout/tagout program specific to the machinery in your facility, including equipment that is not capable of being locked out
- + **Implement** – use lockout devices for equipment that can be locked out and tagout devices to identify who is performing maintenance
- + **Train** – teach employees the lockout/tagout procedures and be sure authorized employees can perform the procedure accurately
- + **Enforce** – monitor and maintain that the implemented procedures are being performed
- + **Inspect** – lockout/tagout procedures as well as employees should be audited at least annually

OSHA Requirements for Padlocks and Devices

The OSHA Lockout/Tagout standard outlines 5 requirements that all safety padlocks and devices must meet. Master Lock safety padlocks and devices were designed to meet all of these requirements.

Requirement	Description	Master Lock LOTO Products
Durable	Manufactured with materials that withstand usage environment	✓
Substantial	Cannot be removed unless considerable force is applied	✓
Standardized	Clearly differentiated from other devices by color, shape or size	✓
Identifiable	Indicates the authorized employee that applied the device	✓
Exclusive for Safety	Not to be used for purposes other than controlling energy	✓

Keying: A Critical Component

“One Employee, One Lock, One Key”

It is important that each employee at a facility has a padlock key that is unique to them. Key charting is critical to prevent duplicate keys from entering the workplace and jeopardizing your lockout/tagout program.



Master Lock offers keying services and options to meet any safety system’s requirements

LifeGuard™

A no-charge Safety Lockout Padlock Key Charting System – critical for Safety Lockout

- Key charting is a record of all the safety padlock key codes assigned to a facility
- It is important that each authorized employee at a site has a unique padlock key that only opens that employee’s safety padlock. This complies with the “one lock, one employee, one key” directive
- To help prevent duplicate keys from jeopardizing your lockout program, register your workplace with Master Lock. Once registered, Master Lock will send you an End User Identification Number for your site’s Key Chart
- When you use that I.D. number on each additional padlock order, Master Lock will use a new key code for each padlock we manufacture for you. When used properly, this free service helps ensure that each employee carries a key unique to them, eliminating unwanted key duplication in a safety lockout program

Keying Options to fit your facility’s needs

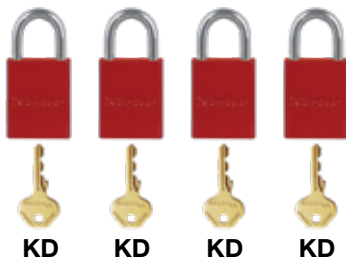

Keyed Different
Each lock is opened by its own unique key which does not open any other lock in the set – complying with the “One lock, one employee, one key” mantra

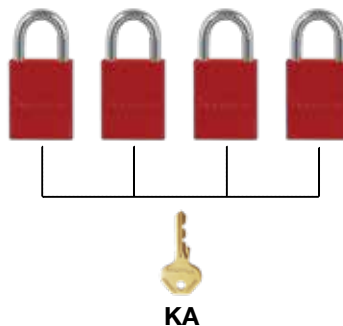

Keyed Alike
All padlocks in the set are opened by the same key so only one key is necessary to open numerous padlocks – for employees who need many locks, they still only have one key

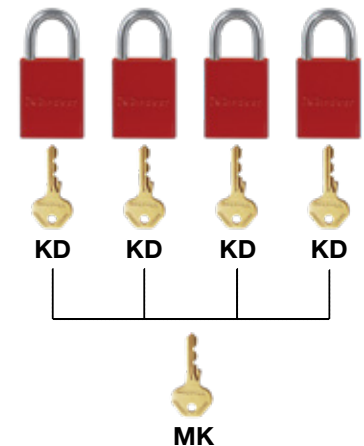

Master Keyed
A master key opens all locks within the system while each lock also has its own unique key – allows for responsible removal of improperly placed or forgotten lockouts according to your emergency notification policy

ZENEX™ THERMOPLASTIC SAFETY PADLOCK FEATURES

Zenex™ Thermoplastic Safety Padlocks

Optimal safety padlock designed exclusively for Lockout/Tagout by Safety Directors. Distinctive Zenex™ Thermoplastic safety padlock is durable, standardized, substantial and identifiable for OSHA 1910.147 compliance. Stands up to chemicals, temperature extremes, and is UV stable.



410

- ▶ Durable padlocks weigh only ounces (400 series 4 oz., S30 Series 3 oz.), making it easy to carry many
- ▶ Withstands extreme temperatures
- ▶ Excellent corrosion resistance
- ▶ UV stable
- ▶ No silicone used in padlock
- ▶ Over 40,000 unique safety key codes available.
- ▶ Keyed Different, Keyed Alike and Master Keyed options
- ▶ Key retaining – ensures padlock is not accidentally left unlocked. S33 non key-retaining for group lockout
- ▶ Available in up to 8 colors
- ▶ Includes one key to ensure compliance with “One Lock, One Employee, One Key” directive
- ▶ Includes write-on “Danger” and “Property Of” labels
- ▶ Body sides and face can be laser engraved for permanent identification
- ▶ Non-rekeyable ensures your safety lockout system stays pure by preventing haphazard rekeying and the accidental introduction of duplicate key codes
- ▶ Your facility’s padlocks can be key charted to ensure no duplicate key numbers are supplied and accidentally handed out to multiple employees
- ▶ Virtually all components are made in the U.S.A.

4100RJ with S142 Label



410RED



410LTGRN



Designed by Safety Directors



VALIDATED

• MASTER LOCK 410 SERIES: 410 AND 410LT CONTAIN A MINIMUM OF 50% RECYCLED CONTENT
UL.COM/ECV

Dielectric Protection



406RED



406BLU



406BLK with S142 Label



UL

VALIDATED

• MASTER LOCK 406 SERIES: 406 CONTAIN A MINIMUM OF 35% RECYCLED CONTENT
UL.COM/ECV

Multilingual Labels Available



411LTTEAL



411YLW with 0411-5705 Label



411PRP

UL

VALIDATED

• MASTER LOCK 411 SERIES: 411 AND 411LT CONTAIN A MINIMUM OF 40% RECYCLED CONTENT
UL.COM/ECV



410 Zenex™ Thermoplastic Safety Padlock

- ▶ 1/4in diameter, 1-1/2in or 3in high plated metal shackles
- ▶ High security, reserved for safety cylinder
- ▶ Key-retaining, ensures padlock is not accidentally left unlocked
- ▶ English, Spanish, and French labels included

Master Lock Model #	Description	Vertical Shackle Clearance (B)	Schematic
410 Safety Padlocks			
1-1/2in Wide, 1-3/4in High Zenex™ Thermoplastic Body. Shackle Dimensions: A: 1/4in C: 25/32in			
410RED	Keyed Different	1-1/2in	
410LTRED	Keyed Different, Extra Length Shackle	3in	
410REDCOV	Keyed Different with Extreme Environment Safety Padlock Cover	1-1/2in	
410KARED	Keyed Alike	1-1/2in	
410KALTRED	Keyed Alike, Extra Length Shackle	3in	
410MKRED	Master Keyed	1-1/2in	
410KAMKRED	Keyed Alike, Master Keyed		
Eight Color Options: Add Desired Color Suffix: RED, YLW, GRN, BLU, BLK, TEAL, PRP, ORJ			
S140	Write on North American English, Spanish, and French. Multilingual label options available. (50 labels/language)		
S142	North American English, Spanish & French Padlock Labels for 406, 410, S31 & S33 (6 pk.)		



410RED

Keyed Alike Sets Available

406 Zenex™ Thermoplastic Non-Conductive, Non-Magnetic, Non-Sparking Safety Padlock

- ▶ Ideal for medical, mining & electrical lockout
- ▶ 1/4in diameter, 1-1/2in high nylon shackle with Zenex™ Thermoplastic body
- ▶ All components are non-sparking and non-magnetic plastic, copper, or brass
- ▶ Exposed components are plastic and do not conduct electricity
- ▶ Shackle withstands over 300 lb pull force

Master Lock Model #	Description	Vertical Shackle Clearance (B)	Schematic
406 Non-Conductive, Non-Magnetic, Non-Sparking Safety Padlocks			
1-1/2in Wide, 1-3/4in High Zenex™ Thermoplastic Body. Shackle Dimensions: A: 1/4in C: 25/32in			
406RED	Keyed Different, Dielectric	1-1/2in	
406REDCOV	Keyed Different with Extreme Environment Safety Padlock Cover		
406KARED	Keyed Alike		
406MKRED	Master Keyed		
406KAMKRED	Keyed Alike, Master Keyed		
Eight Color Options: Add Desired Color Suffix: RED, YLW, GRN, BLU, BLK, TEAL, PRP, ORJ			
S140	Write on North American English, Spanish, and French. Multilingual label options available. (50 labels/language)		
S142	North American English, Spanish & French Padlock Labels for 406, 410, S31 & S33 (6 pk.)		



406YLW

Keyed Alike Sets Available

411 Zenex™ Thermoplastic Bilingual Safety Padlock

- ▶ 3in tall body with 1/4in diameter, 1-1/2in or 3in high plated metal shackles
- ▶ High security, reserved for safety cylinder
- ▶ English/Spanish and English/French combined labels

Master Lock Model #	Description	Vertical Shackle Clearance (B)	Schematic
411 Bilingual Safety Padlocks			
1-1/2in Wide, 3in High Zenex™ Thermoplastic Body. Shackle Dimensions: A: 1/4in C: 25/32in			
411RED	Keyed Different	1-1/2in	
411REDCOV	Keyed Different with Extreme Environment Safety Padlock Cover		
411LTRED	Keyed Different, Extra Length Shackle	3in	
411KARED	Keyed Alike	1-1/2in	
411KALTRED	Keyed Alike, Extra Length Shackle	3in	
411MKRED	Master Keyed	1-1/2in	
411KAMKRED	Keyed Alike, Master Keyed		
Eight Color Options: Add Desired Color Suffix: RED, YLW, GRN, BLU, BLK, TEAL, PRP, ORJ			
S141	Write on North American English/Spanish, English/French. Bilingual options available. (50 labels/language)		
0411-5705	Photo ID labels for 411 padlocks (6 pk.)		



411BLU

Keyed Alike Sets Available



S31 Global Zenex™ Thermoplastic Safety Padlock

- ▶ 3/16in marine grade 316 stainless steel shackle for superior corrosion resistance
- ▶ Key retaining – ensures padlock is not accidentally left unlocked
- ▶ Available with 1-1/2in or 3in tall shackle
- ▶ Patented

S32 Zenex™ Thermoplastic Dielectric Safety Padlock

- ▶ Non-Conductive, Non-Magnetic, Non-Sparking Safety Padlock – all components are plastic, copper or brass
- ▶ Ideal for medical, military, mining & electrical lockout
- ▶ 3/16in diameter x 1-1/2in high plastic shackle
- ▶ Non key retaining – padlock can be left unlocked and snap locked as needed. Ideal for use during group lockout
- ▶ Patented

S33 Global Zenex™ Thermoplastic Snap Lock Safety Padlock

- ▶ 3/16in marine grade 316 stainless steel shackle for superior corrosion resistance
- ▶ Non key retaining – padlock can be left unlocked and snap locked as needed. Ideal for use during group lockout
- ▶ Available with 1-1/2in or 3in tall shackle
- ▶ Patented

Master Lock Model #	Description	Vertical Shackle Clearance (B)	Schematic	
Zenex™ Thermoplastic Safety Padlock				
1-3/8in Wide, 1-7/8in High Zenex™ Thermoplastic Body. Shackle Dimensions: A: 3/16in C: 5/8in				
S31RED	Keyed Different	1-1/2in		
S31LTRED	Keyed Different, Extra Length Shackle	3in		
S31KARED	Keyed Alike	1-1/2in		
S31KALTRED	Keyed Alike, Extra Length Shackle	3in		
S31MKRED	Master Keyed	1-1/2in		
S31KAMKRED	Keyed Alike, Master Keyed			
Zenex™ Thermoplastic Dielectric Safety Padlock				
1-3/8in Wide, 1-7/8in High Body. Shackle Dimensions: A: 3/16in C: 5/8in				
S32RED	Keyed Different	1-1/2in		
S32KARED	Keyed Alike			
S32MKRED	Master Keyed			
S32KAMKRED	Keyed Alike, Master Keyed			
Zenex™ Thermoplastic Snap-Lock Safety Padlock				
1-3/8in Wide, 1-7/8in High Zenex™ Thermoplastic Body. Shackle Dimensions: A: 3/16in C: 5/8in				
S33RED	Keyed Different	1-1/2in		
S33REDCOV	Keyed Different with Extreme Environment Safety Padlock Cover			
S33LTRED	Keyed Different, Extra Length Shackle	3in		
S33KARED	Keyed Alike	1-1/2in		
S33KALTRED	Keyed Alike, Extra Length Shackle	3in		
S33MKRED	Master Keyed	1-1/2in		
S33KAMKRED	Keyed Alike, Master Keyed			
Nine Color Options: Add Desired Color Suffix: RED, YLW, GRN, BLU, BLK, TEAL, PRP, ORJ				
S30COVERS	Extreme Environment Safety Padlock Covers; bag of 12 covers – see page 15			
S140	Write on North American English, Spanish, and French. Multilingual label options available. (50 labels/language)			
S142	North American English, Spanish & French Padlock Labels for 406, 410, S31 & S33 (6 pk.)			



Keyed Alike Sets Available



410KAS3

Safety Padlock Keyed-Alike Sets

Popular quantities of safety padlocks are conveniently packed in sets, simplifying the order process.

Safety Padlock Keyed-Alike Sets

Safety Padlocks Built and Packed in Popular Keyed Alike Quantities

Workers often need to lock out more than one energy source on a single piece of equipment. Keyed alike safety padlocks can help serve this purpose.

To simplify and expedite ordering, Master Lock now offers our Zenex™ Thermoplastic, Aluminum and Steel safety padlocks in popular keyed alike quantities – sets of 3, 6, or 12 locks. These locks are ordered as “1” unit and are packed together making them easy to distribute.

“n” Denotes quantity of padlocks per keyed alike set. Choose quantity and color of set(s) at time of purchase.	
Master Lock Model	Description
Zenex™ Thermoplastic Safety Padlocks, 1/4in dia shackle	
406KASn	
410KASn	Choose quantity per set; 3, 6, or 12 (e.g. 406KAS12RED = twelve red 406KA Padlocks)
411KASn	
Six Color Options: Add Desired Color Suffix: RED, ORJ, YLW, GRN, BLU, BLK	
Zenex™ Thermoplastic Safety Padlocks, 3/16in dia shackle	
S31KASn	Choose quantity per set; 3, 6, or 12
S33KASn	(e.g. S31KAS3BLU = three blue S31KA Padlocks)
Six Color Options: Add Desired Color Suffix: RED, ORJ, YLW, GRN, BLU, BLK	
Anodized Aluminum Safety Padlocks, 1/4in dia shackle	
A1105KASn	Choose quantity per set; 3, 6, or 12
A1106KASn	(e.g. A1105KAS6GRN = six green A1105KA Padlocks)
Four Color Options: Add Desired Color Suffix: RED, BLU, GRN, YLW	
Laminated Steel, 9/32in dia shackle	
3KASn	Choose quantity per set; 3, 6, or 12 (e.g. 3KAS12YLW = twelve yellow 3KA Padlocks)
Six Color Options: Add Desired Color Suffix: RED, YLW, GRN, BLU, BLK, WHT.	



410KAS3RED



411KAS6YLW



A1106KAS12BLU

Note: Contact Master Lock Customer Care to supply your site’s End User Registration ID Number and the key numbers received to update your site’s Key Chart.



S1105RED

ALUMINUM SAFETY PADLOCK FEATURES

- ▶ Durable padlock weighs 5 ounces, making it easy to carry
- ▶ Solid body construction stands up to physical abuse
- ▶ UV stable
- ▶ 1/4in diameter boron steel shackle with plated finish for corrosion resistance
- ▶ Available Keyed Different, Keyed Alike and Master Keyed
- ▶ Available with 1in, 1-1/2in or 3in tall shackle
- ▶ Write on labels and Photo ID labels available
- ▶ Body sides and face can be laser engraved for permanent identification – 6 available spaces
- ▶ Uses FDA approved lubricants safe for use in food processing. No silicone used in padlock

Aluminum Safety Padlocks

Lightweight and durable aluminum body with anodized finish for Lockout/Tagout. Stands up to chemicals, temperature extremes, and is UV stable.

S-series Aluminum Safety Padlocks

Designed specifically for Safety lockout

- ▶ Featuring the W401/W417 Safety Exclusive keyway
- ▶ Key retaining
- ▶ Over 40,000 key changes to meet your system needs
- ▶ Complies with the “One Lock, One Key per Employee” mantra
- ▶ Durable aluminum construction for supreme corrosion resistance
- ▶ LifeGuard™ key charting free of charge

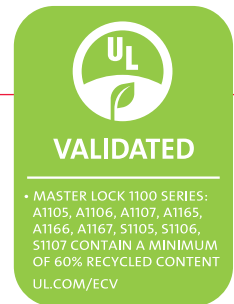

S1100 Series

Anodized aluminum no-chip finish – ideal for food processing facilities

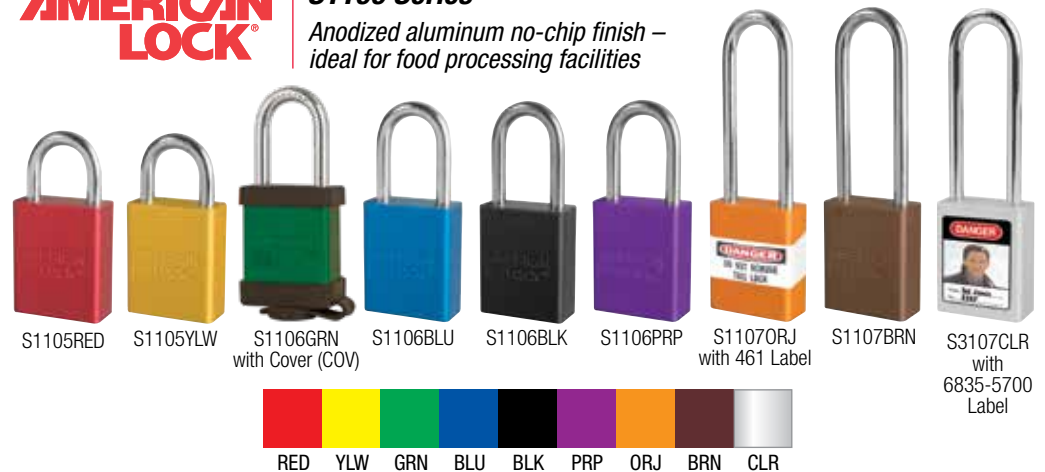

S1105RED S1105YLW S1106GRN with Cover (COV) S1106BLU S1106BLK S1106PRP S1107ORJ with 461 Label S1107BRN S3107CLR with 6835-5700 Label

Model #	Description	Vertical Shackle Clearance (B)	Schematic
S1100 Series Anodized Aluminum Padlocks			
1.5in Wide, 1.820in High Anodized Aluminum Body. Shackle Dimensions: A: 1/4in C: 3/4in			
S1105RED	Keyed Different	1 in	
S1105REDCOV	Keyed Different with Extreme Environment Safety Padlock		
S1105KARED	Keyed Alike		
S1105MKRED	Master Keyed		
S1105KAMKRED	Keyed Alike, Master Keyed		
S1106RED	Keyed Different, Extra Length Shackle	1-1/2in	
S1106KARED	Keyed Alike		
S1106MKRED	Master Keyed		
S1106KAMKRED	Keyed Alike, Master Keyed		
S1107RED	Keyed Different, Extra Length Shackle	3in	
S1107KARED	Keyed Alike		
S1107MKRED	Master Keyed		
Also available as 6-pin; A1165, A1166, A1167			
Nine Color Options: Add Desired Color Suffix: RED, YLW, GRN, BLU, BLK, PRP, ORJ, BRN, CLR			
S101	Extreme Environment Safety Padlock Covers; bag of 12 covers – see page 15		
6835-5700	Photo ID labels for S1100/A1100 series padlocks – 1-1/4in W x 1-3/4in T		
461	Padlock labels with clear overlaminate (50 pk.) - 5in W x 1in T		

Standard Aluminum Padlocks

Anodized Aluminum Safety Padlocks

American Lock A1100 Series



- ▶ Available in 9 colors
- ▶ Durable anodized finish suitable for lockout in food processing facilities
- ▶ Over 10,000 key changes available

American Lock A3100 Series

- ▶ Interchangeable Core Cylinder. Small Format
- ▶ Over 101,000 key changes available



American Lock Model #	Description	Vertical Shackle Clearance (B)	Schematic
A1100 Series Anodized Aluminum Padlocks			
1.5in Wide x 1.820in High Anodized Aluminum Body. Shackle Dimensions: A: 1/4in C: 3/4in			
A1105RED	Keyed Different	1in	
A1105KARED	Keyed Alike		
A1105MKRED	Master Keyed		
A1105KAMKRED	Keyed Alike, Master Keyed		
A1106RED	Keyed Different, Extra Length Shackle	1-1/2in	
A1106KARED	Keyed Alike		
A1106MKRED	Master Keyed		
A1106KAMKRED	Keyed Alike, Master Keyed		
A1107RED	Keyed Different, Extra Length Shackle	3in	
A1107KARED	Keyed Alike		
A1107MKRED	Master Keyed		
Also available as 6-pin; A1165, A1166, A1167			
A3100 Series Interchangeable Core Anodized Aluminum Padlocks			
1.5in Wide x 1.820in High Anodized Aluminum Body. Shackle Dimensions: A: 1/4in C: 3/4in			
A3105RED	Keyed Different	1in	
A3106RED	Keyed Different, Extra Length Shackle	1-1/2in	
A3107RED	Keyed Different, Extra Length Shackle	3in	
Also available as 6-pin; A3165, A3166, A3167			
Nine Color Options: Add Desired Color Suffix: RED, YLW, GRN, BLU, BLK, PRP, ORJ, BRN, CLR			
COV	Extreme Environment Safety Padlock Cover option; add 'COV' to end of Product No. to order (e.g. S1105REDCOV)		
6835-5700	Photo ID labels for S1100/A1100 series padlocks – 1-1/4in W x 1-3/4in T		
461	Padlock labels with clear overlamine (50 pk.) - 5in W x 1in T		

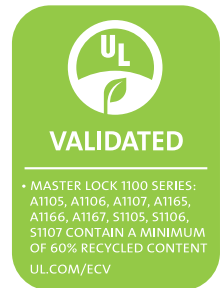

Keyed Alike Sets Available – A1105 and A1106 padlocks

STEEL SAFETY PADLOCK FEATURES

- ▶ Weighs approximately 7 ounces
- ▶ Can withstand extreme temperatures
- ▶ 9/32in diameter shackle
- ▶ Available with 3/4in, 1-1/2in or 2in tall shackle
- ▶ 6 bumper colors available
- ▶ Keyed Different, Keyed Alike and Master Keyed options
- ▶ Over 1400 unique key codes available
- ▶ Optional stamping of key code in key and on bottom plate of padlock available
- ▶ Wrap around, write on labels available for identification
- ▶ Your facility's padlocks can be key charted to ensure no duplicate key numbers are supplied and accidentally handed out to multiple employees
- ▶ Virtually all components made in the U.S.A.
- ▶ Uses FDA approved lubricants safe for use in food processing



3 Steel Safety Padlock

Master Lock Model #	Description	Vertical Shackle Clearance (B)	Schematic
1-9/16in Wide Laminated Steel Body. Shackle Dimensions: A: 9/32in C: 5/8in			
3RED	Keyed Different	3/4in	
3LFRED	Keyed Different, Extra Length Shackle	1-1/2in	
3LHRED	Keyed Different, Extra Length Shackle	2in	
3KARED	Keyed Alike	3/4in	
3KALFRED	Keyed Alike, Extra Length Shackle	1-1/2in	
3KALHRED	Keyed Alike, Extra Length Shackle	2in	
3MKRED	Master Keyed	3/4in	
3KAMKRED	Keyed Alike, Master Keyed		
Six Color Options: Add Desired Color Suffix: RED, YLW, GRN, BLU, BLK, WHT.			
461	Padlock labels with clear overlamine (50 pk.)		



Keyed Alike Sets Available

Breakaway Shackle Padlock

Laminated Steel Padlock with Breakaway Shackle for Emergency Access

- ▶ Ideal for emergency situations where emergency access is needed, such as fire extinguishers and hoses

NOTE: Does not meet OSHA 1910.147 Lockout/Tagout Standard

Master Lock Model #	Description	Vertical Shackle Clearance (B)
500KABRK	Keyed Alike, Warded Locking Mechanism. Breakaway Shackle	13/16in



Steel Safety Padlocks

Strong and economical. Reinforced laminated steel construction stands up to extreme physical abuse.

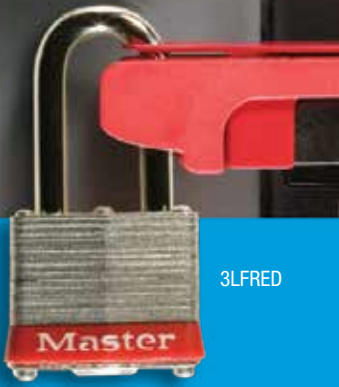



Laser Engraving

Laser Engraving

A Permanent and Durable Method to Customize Your Safety Lockout Padlocks

- ▶ Available on Aluminum and Zenex™ Thermoplastic padlocks
- ▶ A name, logo or key number, you select the important information to engrave on the padlock
- ▶ Laser engrave information on the padlock face, sides or back
- ▶ Contact your preferred distributor or Master Lock for ordering and pricing information
- ▶ Available in many languages; call for details



Padlock Identification

Master Lock has the most comprehensive offering of padlock identification options available.

Padlock Identification Labels



0411-5705



6835-5700



461



S142



Master Lock Model #	Description	Dimensions
0411-5705	Photo ID labels for 411 padlocks (6 pk.)	1in W x 2-3/8in T
6835-5700	Photo ID labels for A1105, A1106, A1107, A1165, A1166, and A1167 padlocks (6 pk.)	1-1/4in W x 1-3/4in T
461	Padlock labels with clear overlaminates (50 pk.)	5in W x 1in T
S140	North American English, Spanish & French Padlock Labels for 410, 406, S31 & S33 (50 labels/language)	1in W x 1-3/16in T
S141	North American English/Spanish, & English/French Padlock Labels for 411 padlocks (50 labels/language)	1in W x 2-3/8in T
S142	Photo ID labels for 410, 406, S31, and S33 Padlocks (6 pk.)	1in W x 1-1/4in T

Extreme Environment Safety Padlock Covers

- ▶ Seals shackle and keyway to help keep out dust and grime from extreme environments
- ▶ Dual strap increases durability and minimizes the obstruction of labels
- ▶ Removable attached keyway cap allows for easier access to keyway (not included on S30COVERS)
- ▶ Available for American Lock S1100 Series and Master Lock S30 Series safety padlock families



Master Lock Model #	Description
S101	For American Lock S1100 and A1100 series padlocks; bag of 12 covers
S30COVERS	For Master Lock S31, S32 & S33 series padlocks; bag of 72 covers

Padlock Chains, Collars & Tags

- ▶ Chains keep padlocks close to equipment requiring safety lockout
- ▶ Engravable brass tag provides for individual worker identification
- ▶ Tags attach to safety lockout padlocks with 71SC8 and 71SC9 collars

Master Lock Model #	Description
71CS	9in long lightweight zinc plated steel chain with chain holder attached; fits all master shackle collars (ordered separately) (12 pk.)
71CH	9in long heavy-duty zinc plated steel chain with chain holder attached; fits all master shackle collars
71SC8	Shackle collar. Fits 1/4in diameter shackles and smaller; for 410, 411, S1100/A1100 padlocks
71SC9	Shackle collar. Fits 9/32in diameter shackles; for 3 laminated steel padlocks
71TAG	1/2in x 1-3/4in brass tag with ring for attaching to shackle collars listed above



71TAG



71CS

71SC8

Safety Padlock Caddy

- ▶ Keep safety padlocks near appropriate machinery
- ▶ Hold up to 12 padlocks based on number of lockout points
- ▶ When locking out, conveniently carry caddy to all lockout points
- ▶ When all padlocks are gone, all lockout points have been met

Master Lock Model #	Description
S125	Safety Padlock Caddy – Carry up to 12 padlocks from lockout job to job



S125 Safety Padlock Caddy

Padlock Accessories

Safety lockout accessories for OSHA compliance.

S101



Hasps

Lockout hasps are integral parts of a successful safety lockout program, providing effective multi-person lockout.

Safety Lockout Hasps

Lockout by Multiple Workers at Each Lockout Point

- ▶ Attach hasp to energy disconnect switch
- ▶ Control cannot be turned on until last worker's padlock is removed from hasp
- ▶ Multiple styles available to fit most needs; **Spark resistant aluminum, Pry-resistant steel, Dielectric plastic, Dual jaw aluminum**

Aluminum



416

417

Tabbed Steel



AL080

AL0802

Steel



420

421

4mm Dia. Shackle Hasp



S430

Heavy Duty Steel



418



419

Dual Jaw Aluminum



429

Dielectric



428

Master Lock Model #	Description	Inside Jaw Clearance	Padlock Capacity
416	Spark Resistant Aluminum 1-1/2in x 4-3/8in	1in	6
417	Spark Resistant Aluminum 2in x 4-7/8in	1-1/2in	6
418	Heavy Duty Steel 2-3/8in x 3-1/4in	1in	4
419	Heavy Duty Steel 2-3/8in x 6-5/8in	3in	8
420	Steel Jaw with Vinyl Coated Handle 1-3/4in x 4-1/2in	1in	6
421	Steel Jaw with Vinyl Coated Handle 2-3/8in x 5in	1-1/2in	6
428	Nylon Non-Conductive Hasp 1-5/8in x 6-7/8in	1in x 2-1/2in	6
429	Dual Jaw Aluminum Hasp 2in x 5-7/8in	1in & 1-1/2in	8
AL080	Tabbed Steel Jaw with Vinyl Coated Handle 1-3/4in x 4-1/2in	1in	6
AL0802	Tabbed Steel Jaw with Vinyl Coated Handle 2-3/8in x 5in	1-1/2in	6

Model 427 – Labeled Snap-On Hasp

- ▶ Combines multiple-person lockout and tagout identification
- ▶ Features an easy-to-apply “snap-on” advantage with its spring-loaded locking arm
- ▶ Fits more lockout points than alternative rivet-hinge labeled lockout hasps
- ▶ Anodized aluminum and stainless steel construction for combined corrosion-resistance and strength
- ▶ Complete with high visibility, re-usable, write-on safety labels (English, French & Spanish)



427



Master Lock Model #	Description	Inside Jaw Clearance	Padlock Capacity
427	Red Labeled Snap-On Hasp 2-7/8in x 7in	1-3/4in x 2-1/8in	5

Grip Tight™ Plus Circuit Breaker Lockouts

Reliable Lockout in More Circuit Breaker Applications

- ▶ Dependability - Consistently attach to breakers and remain secure
- ▶ Efficiency - Compatible with wide variety of circuit breaker handle shapes and sizes
- ▶ Ease of Use - Lightweight, one-piece designs that require no tools for installation
- ▶ Exclusive design features:
 - Model S3821 is compact, which allows for locking out adjacent breakers
 - Model S3821 is suitable for locking out multi-pole breakers and works with most tie-bar toggles
 - Model S3822 has a permanently fixed cleat, which adds physical blocking capability
 - Model S3823 has a fold-down cleat that provides enhanced switch throw blocking when needed

Master Lock Model #	Description
S3821	Lockout Device for Miniature Circuit Breakers (120/240 V)
S3822	Lockout Device for Molded Case Circuit Breakers (480/600 V)
S3823	Lockout Device for Oversized Handle Circuit Breakers (480/600 V)

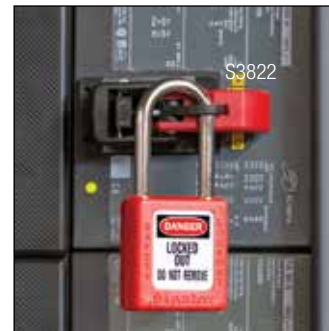

Electrical Lockouts

Master Lock offers innovative, patented and patent pending devices for the effective lockout of electrical shut-off points, including circuit breakers, and electrical plugs.

Fold-Down Cleat
Provides enhanced switch throw blocking when needed



Large Thumbscrew
Knurled texture enables gripping with gloves, offering easy tightening for a secure lockout. Slotted to allow optional screwdriver adjustment



Toothed Jaw
Delivers a tight hold on the circuit breaker handle



Curved Blade
Ensures two-point contact with the switch handle for greater hold

Fixed Cleat
Provides added physical blocking to prevent switch from turning to "on" position

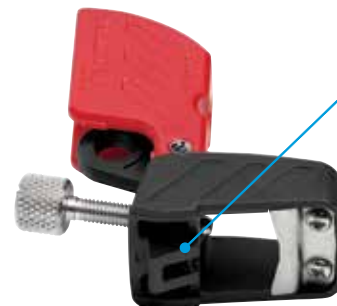

Grip Tight™ Circuit Breaker Lockout

Simplicity Combined with Durability for Effective Lockout

- ▶ Secure and simple mounting for a solid lockout. Holds tight with simple thumb turn and clamping handle
- ▶ Different profiles intended to accommodate unique breaker sizes
 - Model 491B fits tall and wide breaker toggles
 - Model 493B fits standard height and some common tie-bar toggles
- ▶ Compact devices are easy to carry and easy to store
- ▶ Both devices accept all American Lock and Master Lock safety padlock shackle and lockout hasp diameters
- ▶ Durable construction with powder coated steel and reinforced polymer allows operation in harsh environments
- ▶ Patented

Master Lock Model #	Description
491B	Circuit Breaker Lockout – tall and wide toggles
493B	Circuit Breaker Lockout – standard single and double toggles
506	Set of each device – one 491B and one 493B



Miniature Circuit Breaker Lockouts

Locks Out Most Miniature ISO/DIN Circuit Breakers Found Throughout the World

- ▶ S2390 fits standard width toggle openings. Pin out. Black Handle
- ▶ S2391 fits wide toggle openings. Pin out. Red Handle
- ▶ S2394 features thumb-turn dial screw for easy attachment – no tools needed!
- ▶ Works with all Master Lock and American Lock safety padlocks and most lockout hasps
- ▶ S2390, S2391, S2392 Patented devices
- ▶ S2394 Patent pending

Master Lock Model #	Description
S2390	Fits pin-out breakers 11mm or less
S2391	Fits pin-out breakers 11mm to 13mm
S2392	Fits breakers with pin-in toggles
S2393	Fits universal breaker toggles
S2394	Fits universal breaker toggles, tool-free



S2394
Horizontal
Application



S2394



S2393



S2390



S2391



S2392

S2394
Side-by-Side
Application

Circuit Breaker Switch Padlock

Provides the Flexibility to Effectively Lock Out Breaker Switches

- ▶ 3/16in diameter cable shackle allows padlock to properly lock all types of circuit breaker lockout devices
- ▶ Flexible cable allows the compact lock body to be positioned so that the control panel door closes properly
- ▶ Fits the tight space constraints within circuit breaker shut-off boxes
- ▶ Numerous key changes are available to minimize the possibility of unwanted key duplication

Allows Panel Door to Close

Master Lock Model #	Description
7C5RED	1-1/8in wide steel body; 4-pin cylinder; 5in flexible steel cable. Keyed Different



Rotating Electrical Plug Lockouts

Outward/Inward Rotation Allows for Easier Application & Storage

- ▶ Surrounds the electrical plug; protects against accidental reconnection
- ▶ Unique, patented rotating design allows for easier installation in confined space applications
- ▶ Complete with high-visibility permanent safety labels (English, French & Spanish). Labels can be written-on to identify the responsible person, then erased for the next job
- ▶ Tough, lightweight, dielectric Zenex™ Thermoplastic bodies withstand chemicals; perform effectively in extreme conditions

Master Lock Model #	For Electrical Plug Sizes Up To:
487	2-1/4in dia. x 3-1/4in with cord dia. up to 3/4in (110-120 and 220-240 volt plugs)
488	3in dia. x 6in with cord dia. up to 3/4in (Most 240 and 550 volt plugs)



Compact Plug Prong Lockout

Compact Design Locks Out Smaller Plugs Easily & Effectively

- ▶ Locks on the prongs of 110-120 volt plugs
- ▶ Fits two prong plugs with and without ground
- ▶ Use with your existing lockout padlocks or lockout hasps
- ▶ Includes labels in English, Spanish, and French
- ▶ Patented



Master Lock Model #	Description
S2005	Fits 110-120-volt plugs (with or without ground)



S3081

Butterfly Valve Lockout Devices

Locks out virtually all butterfly valves

- ▶ Easy-to-use, adjustable design fits virtually all butterfly valves
- ▶ Locks out valve in seconds by feeding S806 cable lockout device through desired eyelet and around valve neck
- ▶ Stainless steel rivet allows device to smoothly pivot open and closed to ensure proper fit
- ▶ Durable, lightweight Zenex™ Thermoplastic material is chemical resistant and performs effectively in extreme environments
- ▶ Directional application arrows allow for ease of installation and minimize user error

Master Lock Model #	Description
S3920	Butterfly Valve Lockout Device only
S3921	Butterfly Valve Lockout Device + S806CBL3 Adjustable cable lockout

Valve Lockouts

The exclusive, patented Master Lock gate and ball valve lockout devices work in difficult applications like tight spaces and insulated pipes.



S3920 device acts as a wedge between the two handles; locked out with S806 adjustable cable & padlock.

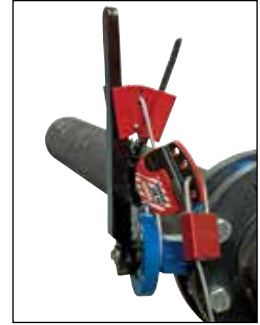

Rotating Gate Valve Lockouts

Outward/Inward Rotation Allows for Easier Installation & Storage

- ▶ Surrounds the valve operating handle to protect against accidental valve opening
- ▶ Multiple workers can apply their lockout hasps or personal safety locks
- ▶ Tough, lightweight, dielectric Zenex™ Thermoplastic bodies withstand chemicals; perform effectively in extreme conditions
- ▶ Unique, patented rotating design allows for easier installation in confined space applications
- ▶ Complete with high-visibility permanent safety labels (English, French & Spanish) that can be written-on to identify the responsible person, then erased for the next job
- ▶ Center knockout can be removed for rising stem gate valves
- ▶ Each size rotates into itself and nests within the next larger size to save space in storage

Master Lock Model #	Description	Depth	Stem Opening
480	1in to 3in dia. valve handles	1-1/16in	3/4in
481	2in to 5in dia. valve handles	1-1/2in	1-1/2in
482	4in to 6.5in dia. valve handles	1-7/8in	2-1/2in
483	6in to 10in dia. valve handles	2-3/4in	3-1/2in
484	8in to 13in dia. valve handles	3-3/8in	4in
485	1 set of 480-484		

Easy to Store Fits in Kits



485



480

482

483

481

Easy to Use Even in Tight Spaces

484



Pressurized Gas Valve Lockout

Fits Pressurized Gas Valves

- ▶ Patented design works with valve guard in place
- ▶ Fits virtually all pressurized gas valve handles up to 3in diameter
- ▶ Compact size easily stored when not being used
- ▶ Accepts any Master Lock or American Lock Safety Padlock
- ▶ Works with lockout hasps for multiple worker lockout



Master Lock Model #	Description	Depth	Stem Opening
S3910	Pressurized Gas Valve Lockout	1in	1-5/8in

Ball Valve Lockout Devices

Effective Lockout for Virtually Any Ball Valve

- ▶ Easy to use – simple, intuitive designs
- ▶ Broad application
 - Devices could lock up ball valves up to 4in
 - Fit virtually all types of pipe including insulated, PVC and metal
- ▶ Lightweight and compact – devices are easy to carry, store and apply even in tight, awkward spaces



S3068 Seal Tight™ Handle-On Lockout

Metal device clamps tight on handle stop. Defies corrosive environments and extreme temperatures.



468L Seal Tight™ Handle-Off Lockout

Device encloses the valve stem, with the handle removed, to make accidental reactivation virtually impossible. Operates in extreme temperatures.



S3081 Adjustable Lockout

Works with S806 cable lockout device for the most secure fit.

S3476/S3477 1/4 Turn Ball Valve Lockout

Fits manual, quarter turn ball valve handles to protect against accidental opening. Easy to use one piece design locks valve in OFF position. Two rows of lock out points allow for a secure fit.

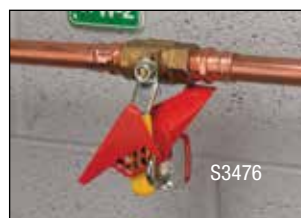

Master Lock Model #	Description	For Valve Diameters of:
S3068	Seal Tight™ Handle-On Ball Valve Lockout 5-3/4in L x 2-1/8in W x 2-1/2in H	1/4in to 4in
468L	Seal Tight™ Handle-Off Lockout, 11-1/2in H x 12-3/4in W x 2-1/2in D	3/8in to 4in
S3081	Adjustable Ball Valve Lockout	1/2in to 2in

Master Lock Model #	Description
S3476	Fits valves between 1/4in (6.35mm) to 1in (25mm) diameter
S3477	Fits valves between 1-1/4in (31mm) to 3in (76mm)

S856



Retractable Cable Lockouts

Adjustable cable lockout devices with Cable Management System for a variety of applications

- ▶ Cable take-up reel encloses the cable to provide protected storage and easy application by managing excess cable length during lockout
- ▶ Internal ratcheting mechanism ensures a secure lockout by only allowing the cable tension to increase, even after locks have been applied
- ▶ Patented 1/8in (3.3mm) diameter x 9ft (2.74m) cable features a colored plastic coating for added durability and visibility
- ▶ Tough, lightweight thermoplastic body withstands chemicals
- ▶ Ergonomic design eases operation when wearing gloves
- ▶ Contoured shape enables easy stacking, storage, and transportation of multiple devices
- ▶ Suitable for group or challenging, multi-point lockout
- ▶ Includes high-visibility, write-on safety labels in English, Spanish and French for easy identification (additional languages available)
- ▶ Replacement cable kits available separately with Steel or Nylon Core Cable; can use either cable type in same device

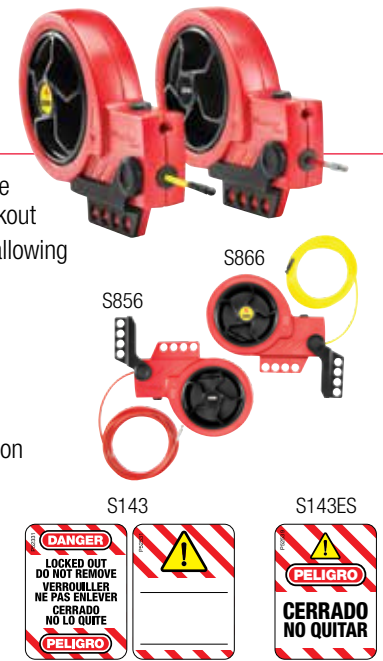

Cable Lockouts

Innovative patented cable lockout devices offer efficient multipoint safety lockout compliance for a variety of safety applications.

Master Lock Model #	Description
S856	Retractable cable lockout device with 9ft (2.74m) x 1/8in (3.3mm) dia. red steel core cable
S866	Retractable cable lockout device with 9ft (2.74m) x 1/8in (3.3mm) dia. yellow nylon core cable
Replacement Parts	
PKGP52709	Replacement cable kit - Steel core cable (Red)
PKGP52711	Replacement cable kit - Nylon core cable (Yellow)
Danger Labels for S856/S866	
S143	Trilingual danger labels (English, French, Spanish) and warning/write-on labels. Pack of 100 labels, 50 of each design
S143FR	Danger labels. French. Pack of 50 labels
S143ZH	Danger labels. Mandarin Chinese. Pack of 50 labels
S143ES	Danger labels. European Spanish. Pack of 50 labels
S143JA	Danger labels. Japanese. Pack of 50 labels
S143DE	Danger labels. German. Pack of 50 labels
S143NL	Danger labels. Flemish. Pack of 50 labels

Adjustable Cable Lockouts

Infinitely Adjustable for a Secure Fit Every Time

- ▶ Integrated safety hasp and cable are ideal for multi-point lockout
- ▶ Feed the cable end through the points to be locked out, then back through the lockout body. Cinch it tight to remove any slack with the patented locking feature
- ▶ Tough, flexible multi-stranded steel cable is insulated with a clear plastic coating
- ▶ Tough, lightweight Zenex™ Thermoplastic body withstands chemicals; performs effectively in extreme conditions (temperature range of -40° F to 200° F)
- ▶ Master Lock S806 includes a 6' cable. Cable available in 1ft increments from 7ft to 50ft
- ▶ Complete with high-visibility write-on safety labels (English, French & Spanish)



Master Lock Model #	Description
3/16in (4mm) Diameter Cable	
S806	6' Adjustable cable lockout
S806CBL3	3' Adjustable cable lockout
S806CBL15	15' Adjustable cable lockout
S806CBL n	Adjustable cable lockout with user-specified cable length of 7' to 50'



S600

Group Lock Box with Wall Mounting Bracket

Manage The Placement And Movement of Group Lock Boxes To Protect Your People

- ▶ Use it where it's needed – Mount with the bracket for routine, daily use; take it portable for remote lockouts; or move to a bracket in another area for large turnarounds
- ▶ Prevent unwanted box removal from the wall with optional locking of box to bracket
- ▶ Monitor the status of group lockouts at a glance with product features that improve lockout verification
- ▶ Store more padlocks and conduct more lockouts within a limited space with this small footprint, large capacity box
- ▶ S3650 comes with 1 lock box and 1 mounting bracket

Master Lock Model #	Description	Dimensions H x L x W
S3650	Group Lock Box with Wall Mounting Bracket	6-7/8in x 3-15/16in x 8-3/8in
PKG57337	Mounting bracket	3.2in x 0.43in x 7.5in

Group Lock Boxes

Made to withstand the toughest environments. Rugged construction offers enhanced design features, making these lock boxes stronger and easier to use.



▶ Control Room ▶ Machine Side ▶ Outdoors ▶ Portable

Rewritable Tag
provides area to write temporary permit-to-work information

Carrying Handle
for portable convenience and easy transportation of locks to energy isolation points

430-Grade Stainless Steel
with heavy-duty powder coat for durability and corrosion resistance

Front Latch
secures door during transit

15-Lock Internal Storage Capacity
for small to medium lockouts

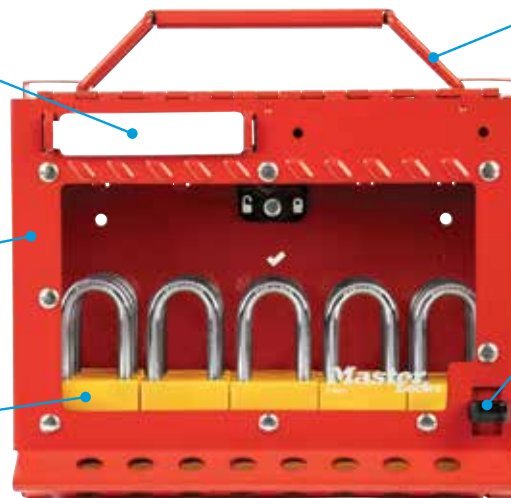

Wall Bracket*
enables easy mounting and redeployment of the lock box

Internal Locking Mechanism allows for optional locking of box to bracket

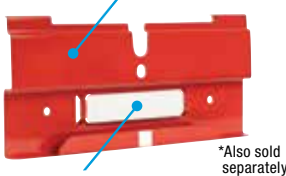

Rewritable Tag*
can be labeled to match box for identification purposes

*Also sold separately

Stamped Checkmark
inside provides visual confirmation of positive attachment when using wall mounting bracket

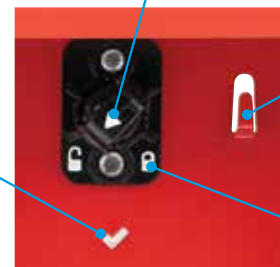

4 Key Hooks
inside display equipment keys individually and keep key numbers visible

Icons
give immediate indication of locked/unlocked status

Group Lock Boxes with Key Window

Heavy-Duty Group Lock Boxes with Key Window that Offer Visual Verification of Secured Keys During Group Lockout

- ▶ Constructed out of 430-grade stainless steel to withstand the toughest environments
- ▶ Each lock box includes a removable cup that creates a clear, impact-resistant window on the front, allowing participants to see keys are secured inside the box during a group lockout
- ▶ All models include 19 total lockout holes, including one on the front latch for the operations lock
- ▶ Models S600 and S601 feature a side window, offering visibility to unused locks
- ▶ The stackable design facilitates storage and simplifies transporting multiple boxes
- ▶ Replacement removable key cups are available

Master Lock Model #	Description	Dimensions H x L x W
S600	Small group lock box	5-13/32in x 9-11/16in x 4-7/8in
S601	Small group lock box with side window for viewing unused locks	
S602	Large group lock box with rewritable label	7-49/64in x 9-11/16in x 4-7/8in



Group Lockout Customization Services Available

- ▶ Master Lock builds group lockout kits containing lock boxes and padlocks configured to customer specifications
- ▶ Group lockout kits increase the efficiency of deploying products on site
- ▶ Contact your Master Lock safety sales representative for more information about our customization and kitting capabilities

Latch Tight™ Group Lock Boxes

Storage Devices Capture Keys for Effective Lockout of Large Equipment

- ▶ Secure each lockout point on a piece of equipment with a single padlock. Place the keys in the group lock box and then each authorized employee places their personal padlock on the lock box
- ▶ When work is complete, employees take their personal padlocks off the lock box, freeing the keys inside. Keys inside cannot be accessed until the last employee removes their padlock
- ▶ Feature an exclusive, patented Latch Tight™ locking mechanism that prevents keys from being accessed until the last padlock or lockout hasp is removed from the box. Provides the highest level of security available in a group lock box
- ▶ Lockout message on box is in three languages – English, Spanish and French
- ▶ Cold-rolled steel with durable powder-coated finish and stainless steel handle

498A

- ▶ Portable solution
- ▶ Available in Red
- ▶ Accepts 12 padlocks or lockout hasps
- ▶ Secures multiple keys

503RED/503YLW

- ▶ Can be mounted to wall or carried from job to job
- ▶ Accepts 14 padlocks or lockout hasps
- ▶ Secures multiple keys
- ▶ Includes organized storage for 12 keys in back of box



Master Lock Model #	Description	Dimensions H x L x W
498A	Portable group lock box	6in x 9-1/4in x 3-3/4in
503RED	Dual application group lock box - Red	12-3/4in x 3-1/2in x 6-3/8in
503YLW	Dual application group lock box - Yellow	12-3/4in x 3-1/2in x 6-3/8in

Modular Permit Control Station

A single location to display and protect paperwork and padlocks for group lockout

- ▶ 430-grade stainless steel with heavy-duty powder coating withstands outdoor elements and provides corrosion resistance
- ▶ Wall mounted for accessibility or use on-the-go for convenience
- ▶ Clear, impact-resistant windows for viewing permit and key(s) during lockout
- ▶ Rubber seal on permit display case protects documents from water damage in outdoor applications or during cleaning
- ▶ Group lock box has 12 numbered lock holes for personal safety locks, plus a latch hole designated for the control lock
- ▶ Includes removable lock caddy for easy transportation of equipment locks to isolation points during lockout

Product Number	Description
S3500	Permit Control Station (Includes S3501 and S3502)
S3501	Permit Display Case
S3502	Wall Mount Group Lock Box

Permit Control Station

Place group lockout where you need it to effectively communicate the status and details of permit-to-work jobs.



S3500



S3500



S3501



S3502



S3502



S3500



S3924

Blind Flange & Pneumatic Lockouts

Best-in-class lockout solution for pipeline maintenance and innovative ways to lock out virtually any pneumatic fitting.

Blind Flange Lockout

Device provides a physical barrier preventing unwanted blind removal during pipeline maintenance

- ▶ Ideal solution for protecting workers from hazards during pipeline maintenance
- ▶ Device fully conceals flange bolts preventing access to the blind until all work has been completed
- ▶ Easy-to-use, adjustable device provides a tight fit, adapting to multiple flanged pipe applications
- ▶ Three models designed to cover and lock out flange nuts ranging from 3/4in (19mm) to 2-3/4in (69.9mm) diameter and flange widths ranging from 1-1/2in (38.1mm) to 17-7/8in (447.8mm)
- ▶ Durable powder coated aluminum and hardened steel slide bar withstand conditions indoors and out
- ▶ Trilingual, write-on "Danger" labels provided for additional safety ID

Size Chart

Master Lock Model #	Pipe Diameter Range	Nut Diameter	Flange Width Range
S3922	1/2in – 3in (12.7mm – 76.2mm)	3/4in – 1-1/8in (19mm – 28.7mm)	1-1/2in – 5-5/8in (38.1mm – 143.3mm)
S3923	3-1/2in – 12in (88.9mm – 304.8mm)	1in – 1-7/8in (33.3mm – 47.8mm)	3-3/4in – 10-3/4in (95.3mm – 274.6mm)
S3924	14in – 24in (355.6mm – 609.6mm)	2in – 2-3/4in (52.3mm – 69.9mm)	7-3/4in – 17-7/8in (196.9mm – 447.8mm)



S3922
Blind Flange Lockout,
Small

S3923
Blind Flange Lockout,
Medium

S3924
Blind Flange Lockout,
Large

Pneumatic Lockout

Prevents Pneumatic Fitting From Being Connected to Pressurized Air Source

- ▶ Fits virtually all male pneumatic fittings
- ▶ Stainless steel construction for corrosion resistance
- ▶ Measures 1-3/8in wide x 7-3/4in tall x 1/8in thick
- ▶ Accepts any Master Lock or American Lock Safety Padlock with shackle diameter up to 9/32in
- ▶ Works with lockout hasps for multiple worker lockout
- ▶ Accommodates 1/4in, 5/16in, 3/8in, 7/16in, 1/2in, 9/16in, 5/8in, 13/16in connections



S3900

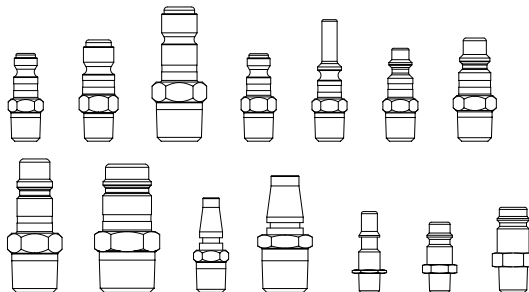

Master Lock Model #	Description
S3900	Stainless Steel Pneumatic Lockout

Removable and Permanent Push Button and Rotary Switch Covers

Temporarily prohibit access or avoid the nuisance of changing rotary switch settings with these durable, versatile, push button & switch covers. Available in both removable and installed versions, covers feature a clear base and cover to allow visibility of nameplates, labels or rotary switch knobs.

- ▶ Fits both 30.5mm and 22.5mm diameter switches

S2151 Removable Push Button and Rotary Switch Cover

- ▶ Accommodates buttons up to 2in (50mm) diameter and 1-3/4in (45mm) tall
- ▶ Includes one cover, one install base and one retrofit base with double-faced adhesive tape
- ▶ S2152AST pack of 12 install bases allows one S2151 to service multiple switches on same panel



S2153 Permanent/Installed Push Button and Rotary Switch Cover

- ▶ Captured by the rotary or pushbutton switch bezel
- ▶ Accommodates buttons up to 1-9/16in (40mm) diameter and 1-3/4in (45mm) tall



S2152AST Install Bases

- ▶ Use with S2151
- ▶ Pack of 12 install bases
- ▶ Allows one S2151 removable cover to service multiple switches on same panel



S2154AST Retrofit Install Bases

- ▶ Use with S2151
- ▶ Pack of 12 horse-shoe shaped retrofit bases with double-faced adhesive tape
- ▶ Allows for use with raised nameplates and off-center installation to accommodate rotary switch knobs



Master Lock Model #	Description
S2151	Removable Button and Switch Cover
S2153	Installed Button and Switch Cover
S2152AST	Install Bases for S2151 Removable Cover (12 pk.)
S2154AST	Retrofit Install Bases for S2151 Removable Cover (12 pk.)



S2152AST



S2154AST

Electrical Covers

Versatile, durable designs address need for temporarily prohibiting access to a switch or control or to avoid nuisance changing of rotary switch settings.

Universal Wall Switch Cover

Locks Out Both Toggle and Decora® Paddle Wall Switches

- ▶ Patented design assures switch is kept on or off
- ▶ Hinges open for unobstructed normal operation of switch
- ▶ Includes English/Spanish and English/French labels



Patented Innovative Design



Master Lock Model #	Description
496B	Universal Wall Switch Cover

Hoist Cover

Effectively Covers Hoist Controls

- ▶ The cinch sack offers broad application solutions
- ▶ Insert PVC tubing (not available through Master Lock) to block access to hoist control buttons
- ▶ Flexible & durable rip-stop nylon bag fits easily in safety tool boxes
- ▶ Lock out with up to 6 padlocks or hasps

Master Lock Model #	Description	Dimensions
453L	Large Nylon Oversized Plug & Control Cover	7in dia. x 17in tall
453XL	Extra Large Nylon Oversized Plug & Control Cover	10in dia. x 26in tall



453L



Hoist Control Cover

Compact Lockout Pouches

Electrical Padlocks and Devices Stored for Convenience

- ▶ Compact, convenient design
- ▶ Hook and loop straps on back allow pouch to be easily applied to or removed from a belt
- ▶ Straps also serve as breakaway feature in the event the pouch is caught in machinery, protecting the employee

Master Lock Model #		Description
410RED Zenex™ Thermoplastic Padlock(s)	Unfilled	
S1010E410	S1010	Electrical Lockout Focus. Contains: 1 – Padlock; 1 – 7C5RED Breaker Switch Padlock; 1 – 420 Hasp; 2 – 493B, 1 – 491B Circuit Breaker Lockouts; 1 – 497A Tags (12 pk.).

Lockout Kits

The Master Lock Lockout Kits combine and organize commonly used electrical and valve lockout devices for individuals or groups of workers.



S1010E410

Personal Lockout Pouches

Padlocks and Devices for Individual Workers

- ▶ Zippered pouch is easy to carry or wear with adjustable waist strap
- ▶ Two standard assortment kits available, one designed with an electrical lockout focus, the other for general maintenance
- ▶ Personal Lockout Pouches are for an individual worker; padlocks are supplied keyed-alike for added worker convenience

Master Lock Model #		Description
410RED Zenex™ Thermoplastic Padlock(s)	Unfilled	
1456E410	1456	Electrical Lockout Focus. Contains: 1 – Padlock; 1 – 7C5RED Breaker Switch Padlock; 1 – 420 Hasp; 2 pcs – 493B, 1 pc – 491B Circuit Breaker Lockouts; 1 – 497A Tags (12 pk.)
1456P410KA		Padlocks & Tags. Contains: 3 – Padlocks Keyed Alike; 1 – 420 Hasp; 1 – 497A Tags (12 pk.)



1456E410

THE RIGHT PADLOCKS FOR YOUR NEEDS.



Zenex™ Thermoplastic Padlocks

Non-conductive, lightweight bodies with permanent write-on labels for worker identification. Key retaining feature ensures that padlocks are not left unlocked. Reserved-for-Safety, high security, 6-pin cylinder offers over 100,000 possible key changes.



Personal Ultra-Durable Lockout Kits

Electrical, Valve and Combined Lockout/Tagout Toolboxes

- ▶ Upgraded safety lockout toolbox keeps important lockout devices and padlocks together
- ▶ Kits include high-use components, satisfying most lockout applications
- ▶ Personal kits are for an individual worker; padlocks are supplied **keyed-alike** for added worker convenience

Master Lock Model #		Description
410RED Zenex™ Thermoplastic Padlock(s)	Unfilled	
1457E410KA	S1017*	Electrical Lockout Focus. Contains: 3 – Padlocks; 1 – 7C5RED Circuit Breaker Padlock; 1 – 420 Hasp; 1 – 427 Snap-On Hasp; 2 – 491B, 3 – 493B Circuit Breaker Lockouts; 1 – 496B Wall Switch Cover; 1 – 497A Tags (12 pk.)
1457V410KA		Valve Lockout Focus. Contains: 3 Padlocks; 1 – 420 Hasp; 1 – 427 Snap-On Hasp; 1 – S806 Adjustable Cable Lockout; 1 – 480, 1 – 481 & 1 – 482 Gate Valve Covers; 1 – 468L & 1 – S3068 Ball Valve Lockouts; 1 – 497A Tags (12 pk.)
1457VE410KA		Electrical & Valve Lockout Focus. Contains: 3 – Padlocks; 1 – 7C5RED Circuit Breaker Padlock; 1 – 420 Hasp; 1 – 427 Snap-On Hasp; 1 – S806 Adjustable Cable Lockout; 1 – 480, 1 – 481 & 1 – 482 Gate Valve Covers; 1 – 468L & 1 – S3068 Ball Valve Lockouts; 2 – 491B, 3 – 493B Circuit Breaker Lockouts; 1 – 496B Wall Switch Cover; 1 – 497A Tags (12 pk.)



*Unfilled toolboxes also available in 23in (S1023)

Group Lockout Kits

Modular Lockout/Tagout Organizers

- ▶ Lightweight safety lockout carrying case, 15in W x 9-1/2in T x 7in D, with modular, translucent storage compartments for improved organization and fast component selection
- ▶ Kits include high-use components, satisfying most applications
- ▶ Separate compartments for effective grouping of (1) padlocks & hasps, (2) valve lockout & (3) electrical lockout components
- ▶ Group kits are for multiple workers; padlocks are supplied **keyed-different**, so that no unwanted key interchange occurs
- ▶ **LifeGuard™** safety padlock key charting system available at no charge.

Master Lock Model #		Description
410RED Zenex™ Thermoplastic Padlock(s)	Unfilled	
1458E410	1458	Electrical Lockout Focus. Contains: 6 – Padlocks; 2 – 7C5RED Breaker Switch Padlocks; 1 – 420 Hasp; 1 – 427 Snap-On Hasp; 1 – S806 Adjustable Cable Lockout; 1 – 487 & 1 – 488 Plug Covers; 4 pcs – 493B, 2 pcs – 491B Circuit Breaker Lockouts; 2 pcs – 496B Wall Switch Covers; 2 – 497A Tags (12 pk.)
1458V410		Valve Lockout Focus. Contains: 6 – Padlocks; 1 – 420 Hasp; 1 – 427 Snap-On Hasp; 1 – S806 Adjustable Cable Lockout; 1 – 480, 1 – 481, 1 – 482 & 1 – 483 Gate Valve Covers; 1 – 468L & 1 – S3068 Ball Valve Lockouts; 2 – 497A Tags (12 pk.)
1458VE410		Electrical & Valve Lockout Focus. Contains: 6 – Padlocks; 2 – 7C5RED Breaker Switch Padlocks; 1 – 420 Hasp; 1 – 427 Snap-On Hasp; 1 – S806 Adjustable Cable Lockout; 1 – 487 & 1 – 488 Plug Covers; 1 – 480, 1 – 481 & 1 – 482 Gate Valve Covers; 6 – 493B, 3 pcs – 491B Circuit Breaker Lockouts; 2 – 496B Wall Switch Covers; 1 – 468L & 1 – S3068 Ball Valve Lockouts; 2 – 497A Tags (12 pk.)



* Provided that your Registered System Number is included on all future orders.



Padlock Stations

Durable stations for the protection of, and easy access to, padlocks

- ▶ Integrated, one-piece molded construction eliminates loose parts
- ▶ Exclusive translucent cover protects contents
 - Lockable to prevent loss of valuable safety lockout padlocks. Recommend using a combination lock for simple access control
 - Innovative hinge holds cover open for easy product selection
- ▶ Available with your choice of Zenex™ Thermoplastic, Aluminum padlocks in 4, 10 or 20 lock formats
- ▶ Safety Hasps and Tags included
- ▶ **LifeGuard™** safety padlock key charting system available at no charge.

Padlock Stations

These durable, user-friendly stations provide a central location for lockout padlocks, tags and hasps.



1482BP410



1484BP1106FRC
(175 Padlock available separately)

CHOOSE THE PADLOCKS FOR YOUR NEEDS.

Master Lock
Zenex™ Thermoplastic Padlocks
 Non-conductive, lightweight bodies with permanent write-on labels for worker identification. Key retaining feature ensures that padlocks are not left unlocked. Reserved-for-Safety, high security, 6-pin cylinder offers over 100,000 possible key changes.



AMERICAN LOCK
Anodized Aluminum Padlocks
 Heavy duty padlocks feature a durable anodized finish. The 5-pin cylinder offers over 10,000 key changes to minimize risk of key number duplication within a facility.



Master Lock Model #			Description	Size (H x W x D)
410RED Zenex™ Thermoplastic Padlock(s)	A1106RED Aluminum Padlock(s)	Base and Cover (Unfilled)		
1482BP410	1482BP1106	1482B	4-Lock Station. Contains 4 – Padlocks; 2 – 420 Hasps; 1 – 497A Tags (12 pk.)	12-1/4 x 16 x 1-3/4
1483BP410	1483BP1106	1483B	10-Lock Station. Contains 10 – Padlocks; 2 – 420 Hasps; 2 – 497A Tags (12 pk.)	15-1/2 x 22 x 1-3/4
1484BP410	1484BP1106	1484B	20-Lock Station. Contains 20 – Padlocks; 4 – 420 Hasps; 4 – 497A Tags (12 pk.)	22 x 22 x 1-3/4
English/Spanish Stations				
1482BP410ES	1482BP1106ES	1482BES	4-Lock Station. Contains 4 – Padlocks; 2 – 420 Hasps; 1 – 497AX Tags (12 pk.)	12-1/4 x 16 x 1-3/4
1483BP410ES	1483BP1106ES	1483BES	10-Lock Station. Contains 10 – Padlocks; 2 – 420 Hasps; 2 – 497AX Tags (12 pk.)	15-1/2 x 22 x 1-3/4
1484BP410ES	1484BP1106ES	1484BES	20-Lock Station. Contains 20 – Padlocks; 4 – 420 Hasps; 4 – 497AX Tags (12 pk.)	22 x 22 x 1-3/4
English/French Stations				
1482BP410FRC	1482BP1106FRC	1482BFRC	4-Lock Station. Contains 4 – Padlocks; 2 – 420 Hasps; 1 – 497ABLC Tags (12 pk.)	12-1/4 x 16 x 1-3/4
1483BP410FRC	1483BP1106FRC	1483BFRC	10-Lock Station. Contains 10 – Padlocks; 2 – 420 Hasps; 2 – 497ABLC Tags (12 pk.)	15-1/2 x 22 x 1-3/4
1484BP410FRC	1484BP1106FRC	1484BFRC	20-Lock Station. Contains 20 – Padlocks; 4 – 420 Hasps; 4 – 497ABLC Tags (12 pk.)	22 x 22 x 1-3/4

*Provided that your Registered System Number is included on all future orders.



S1745E410

Compact Stations

Our padlock racks and lockout stations are ideal for positioning machine-specific lockout devices, tags and padlocks near the lockout point.

Heavy-Duty Padlock Racks

- ▶ Heavy gauge steel with durable powder coat finish to ensure long life
- ▶ Includes labels in English, Spanish/English, and French/English

Master Lock Model #	Description
S1506	6.25in wide x 3in tall x 1.5in deep. Holds 6-8 padlocks
S1518	17.5in wide x 3in tall x 1.5in deep. Holds 18-22 padlocks



S1518



S1506



Compact Lockout Stations

Compact Lockout Station Holds Machine Specific Lockout Devices and Padlocks Near Lockout Point

- ▶ Durable construction for years of use in corrosive environments
- ▶ 4 hanger clips for safety padlocks or hasps
- ▶ Includes face labels in English, Spanish/English or French/English
- ▶ Available filled or unfilled
- ▶ Filled centers available with Zenex™ Thermoplastic Safety Padlocks
- ▶ Measures 9-3/4in tall x 7-3/4in wide x 3-3/8in deep
- ▶ Bin measures 6-1/2in wide x 2-7/8in tall x 2-7/8in deep



S1745E410

Master Lock Model #		Description
410RED Zenex™ Thermoplastic Padlock(s)	(Unfilled)	
S1705P410	S1700	Contains: 1 – Padlock, 1 – 421 Hasp and 2 – Tags
S1720E410	S1700	Contains: 2 – Padlocks, 4 – Tags, 2 – 491B and 2 – 493B Circuit Breaker Lockouts
S1745E410	S1700	Contains: 1 – Padlock, 1 – 488 Plug Lockout, and 1 – Tag

S1700

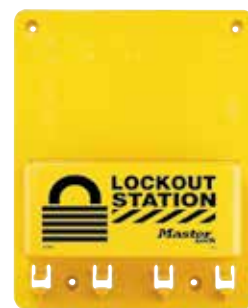

S1705P410



S1720E410
(Hasps available separately)



Deluxe Lockout Station

Large Capacity Lockout Station Holds Departmental Lockout Needs

- ▶ Durable construction ensures long life in your facility
- ▶ Upper and lower sections lockable to ensure devices are there when needed for lockout. Add a combination lock for simple access control
- ▶ 16 hanger clips hold 2 padlocks or lockout hasps each
- ▶ Covered compartments protect devices and keep dust and grime out
- ▶ Moveable dividers in top and bottom trays help organize devices
- ▶ Holes provided along bottom for optional peg hook hangers. Use to hang large, bulky devices
- ▶ Available filled or unfilled
- ▶ Upper unit ideal for larger lockout devices and padlocks. Lower unit ideal for tags and smaller lockout devices
- ▶ Lower unit has two tip-out drawers. Each measures 10in wide x 6-7/8in high x 3-1/4in deep
 - Dividers included to create 2, 3, 4, 5 or 6 compartments
 - Each compartment holds 25 tags. Total capacity of lower unit is 150 tags
- ▶ Measures 26-1/2in high x 22in wide x 4-1/8in deep
- ▶ **LifeGuard™** safety padlock key charting system available at no charge. See page 5 for details

Master Lock Model #		Description
410RED Zenex™ Thermoplastic Padlock(s)	(Unfilled)	
S1900VE410	S1900	Contains: 6 – Padlocks; 2 – 420 Hasps; 1 – 427 Snap-On Hasp; 1 – S806 Adjustable Cable Lockout; 1 – 480, 1 – 481, 1 – 482 & 1 – 483 Gate Valve Lockouts; 1 – 468L & 1 – S3068 Ball Valve Lockouts; 1 – S2005 Compact Plug Prong Lockout; 1 – 488 Plug Cover; 2 – 491B, 6 – 493B Circuit Breaker Lockouts; 2 pcs – 496B Wall Switch Covers; 2 – 497A Tags (12 pk.). Space for additional padlocks or lockout devices as desired
Bilingual Stations		
S1900VE410ES	S1900ES	English/Spanish Station: Standard VE Assortment; 2 – 497AX English/Spanish Tags replace 497A's
S1900VE410FRC	S1900FRC	English/French Station: Standard VE Assortment; 2 – 497BLC English/French Tags replace 497A's



S1850E410

Lockout Stations

These durable, user-friendly wall stations offer the ultimate storage space for large facilities or multiple departmental use.

CHOOSE THE PADLOCKS FOR YOUR NEEDS.

Master Lock

Zenex™ Thermoplastic Padlocks

Non-conductive, lightweight bodies with permanent write-on labels for worker identification. Key retaining feature ensures that padlocks are not left unlocked. Reserved-for-Safety, high security, 6-pin cylinder offers over 100,000 possible key changes.



AMERICAN LOCK

Anodized Aluminum Padlocks

Heavy duty padlocks feature a durable anodized finish. The 5-pin cylinder offers over 10,000 key changes to minimize risk of key number duplication within a facility.



S1900VE410

Lockable Covers



Adjustable Dividers



Additional Storage on Top



Lockout Station

Lockout Station Holds Locks, Hasps and Devices

- ▶ Durable construction for years of use in corrosive environments
- ▶ Top and bottom compartments each have 5 moveable dividers for organizing devices
- ▶ 8 hanger clips hold 2 padlocks or lockout hasps each
- ▶ Holes provided inside and along bottom for optional peghook hanger clips. Allows you to organize further. Large devices can be hung below
- ▶ Cover protects padlocks and devices from dust and grime
- ▶ Lockable. Use combination padlock to limit access to authorized employees
- ▶ Measures 15-1/2in high x 22in wide x 4-1/8in deep
- ▶ Available with Electrical or Valve Lockout Focus. Includes most commonly required lockout devices
- ▶ Available filled or unfilled
- ▶ **LifeGuard™** safety padlock key charting system available at no charge. See page 5 for details

Master Lock Model #			Description
410RED Zenex™ Thermoplastic Padlock(s)	A1106RED Aluminum Padlock(s)	(Unfilled)	
S1850E410	S1850E1106	S1850	Electrical Lockout Focus. Contains: 6 – Padlocks; 1 – 420 Hasp; 1 – 427 Snap-On Hasp; 1 – S2005 Compact Plug Prong Lockout; 1 – 488 Plug Cover; 2 – 491B, 4 – 493B Circuit Breaker Lockouts; 2 – 496B Wall Switch Covers; 2 – 497A Tags (12 pk.)
S1850E410ES	S1850E1106ES	S1850ES	English/Spanish Station; S1850 Electrical Assortment – English/Spanish 497AX Tags replace 497A's
S1850E410FRC	S1850E1106FRC	S1850FRC	English/French Station; S1850 Electrical Assortment – English/French 497ABLC Tags replace 497A's



S1850 (Unfilled)



S1850E410ES

Deluxe Tag Center

Deluxe Tag/Lockout Center Holds Multiple Groups of Tags

- ▶ Durable construction for years of use in corrosive environments
- ▶ Two tip-out drawers with dividers to create 2, 3, 4, 5 or 6 compartments
- ▶ 8 hanger clips along bottom hold safety padlocks or hasps
- ▶ Each compartment holds 25 tags. 150 tag capacity
- ▶ Compartments can be used for lockout devices too
- ▶ Each tip-out drawer measures 10in wide x 6-7/8in tall x 3-1/4in deep inside
- ▶ Upper tray for zip ties and small lockout devices
- ▶ Lockable. Use combination padlock to limit access to authorized employees
- ▶ Also suitable for ear plugs and eyewear



S1800

Master Lock Model #	Description	Dimensions (H x W x D)
S1800	Tag Center (unfilled)	11in x 22in x 4-1/8in

“DO NOT OPERATE” Safety Tags

Laminated Tags Comply with OSHA Lockout/Tagout Standard

- ▶ Durable polyester laminate resists water, grease and extreme temperatures
- ▶ Heavy duty construction withstands over 50 lbs. of pull force (meets OSHA requirement); prevents accidental removal
- ▶ Write-on name, department, expected completion
- ▶ 7/16in dia. brass grommet accepts all safety padlocks
- ▶ Single language and bilingual tag options
- ▶ Tags available in other languages; call for details



Master Lock Model #	Description	Dimensions (H x W)
497A	English, 1 bag of 12 tags with ties	5-3/4in x 3-1/8in
497AX	Spanish/English 1 bag of 12 tags with ties	5-3/4in x 3-1/8in
497ABLC	French/English 1 bag of 12 tags with ties	5-3/4in x 3-1/8in

Safety Tags

Identification tags are key components to any safety lockout program. Master Lock offers write-on tags in English, Spanish and French to accommodate employee needs.

“DO NOT OPERATE” Self Laminating Photo ID Safety Tags

Provides a Visual Representation of the Affected Employee

- ▶ Durable Polypropylene with PVC laminate overlay resists water, grease, extreme temperatures, and common industrial chemicals
- ▶ Heavy duty construction withstands over 50 lbs. of pull force (meets OSHA requirement); prevents accidental removal
- ▶ 3/8in diameter brass grommet accepts all safety padlocks and hasps
- ▶ Customize with name, department, and employee specific photo ID
- ▶ Single language and bilingual tag options



Master Lock Model #	Description	Dimensions (H x W)
S4800LEN	English with European Danger Symbol, 1 bag of 12 tags with ties	5-4/5in x 3-1/5in
S4800LES	Spanish with European Danger Symbol, 1 bag of 12 tags with ties	
S4801	English, 1 bag of 12 tags with ties	
S4802LEN	English with U.K. Prohibition Symbol, 1 bag of 12 tags with ties	



“DO NOT OPERATE” Roll of Tags

Roll of disposable Safety tags stored in portable box for convenience

- ▶ Roll of tags in portable dispenser box makes organization and transportation easy – Box dimensions: 7-7/8in x 4-1/4in x 4-1/4in (200mm x 108mm x 108mm)
- ▶ 3/8in (9.5mm) diameter reinforced opening to accept all safety padlock shackles
- ▶ 6in x 3in (152mm x 76mm) tag with “DO NOT OPERATE” message
- ▶ Made of durable polypropylene material for chemical resistance
- ▶ Can be marked with pencil, pen, and permanent marker
- ▶ Available in 4 languages – English, Spanish, French, and Portuguese



S4810



S4810LES



S4810LFR



Master Lock Model #	Description	Dimensions (H x W)
S4810	English, 1 roll of 100 tags	6in x 3in
S4810LES	Spanish, 1 roll of 100 tags	
S4810LFR	French with European Danger Symbol, 1 roll of 100 tags	
S4810LPT	Portuguese, 1 roll of 100 tags	
S4810LENUK	English with European Danger Symbol, 1 roll of 100 tags	



S4810LPT



S4810LENUK

Maintenance Lockout Tags

Disposable Safety tags for temporary lockout

- ▶ Compact size allows for application in virtually any area
- ▶ Durable laminated material withstands extreme environments
- ▶ Attach with your personal padlock - hassle free, no zip tie needed
- ▶ Accepts up to 9/32in (7mm) shackle diameter
- ▶ Can be marked with pencil, pen, and permanent marker
- ▶ Complies with OSHA standards
- ▶ Available in 4 languages – English, Spanish, French, and Portuguese



S297



S297LES



S297LFR

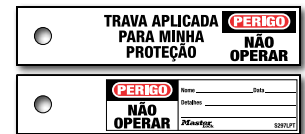

S297LPT

Master Lock Model #	Description	Dimensions (H x W)
S297	English, 1 bag of 100	1-1/4in x 5-1/2in
S297LES	Spanish, 1 bag of 100	
S297LFR	French with European Danger Symbol, 1 bag of 100	
S297LPT	Portuguese, 1 bag of 100	



Guardian Extreme™ Safety Tags

Make sure your safety message is clearly visible for years and years with Guardian Extreme™ tags.

Guardian Extreme™ Safety Tags

Our process permanently fuses the safety message into rugged, industrial grade polypropylene, creating the longest lasting tags available. These graphics remain vibrant and clear for years – even when exposed to high humidity, UV radiation, harsh chemicals, frequent wash downs, extreme high and low temperatures and more.

Metal detectable versions available for use in food processing and pharmaceutical facilities.

Environmentally Friendly is Business Friendly

Guardian Extreme™ lifetime tags and signs withstand tough environments and abuse eliminating the cost of replacement.

Rewrite-Reuse

Modify the message as often as needed

Guardian Extreme™ signs and tags provide the ultimate flexibility. You add the exact safety message for the job with permanent marker, erase it when the work is complete and repurpose it for the next job.



Wipe off current message with Isopropyl Alcohol



Cleaned tag ready for next message - write new message with permanent marker



A brand new message is ready for the next project

Guardian Extreme™ Safety Tags 3in x 5-3/4in (Bag of 6)



S4002



S4002MT
(Metal Detectable)



S4046
(Red)



S4050
(Yellow)



S4060
(Yellow)

Safety Lockout Planograms

Four planograms are organized to focus on different types of lockout – electrical lockout, plumbing lockout and general lockout



Safety Lockout Planograms

Assortments of safety padlocks, lockout devices, tags and kits suited for a variety of lockout requirements.



1337LGENIND

1337SMGENIND

1336ELECT

1336PLMB

Master Lock Model #	Description	1337LGENIND	1337SMGENIND	1336ELECT	1336PLMB
S1010DELECKIT	Electrical Lockout Kit	X		X	
S1010DGCKIT	General Contractor Lockout Kit	X	X		
497AD	Lockout Identification Tags	X	X	X	X
410TRIRED	Keyed-Alike Set of 3 Zenex™ Thermoplastic Safety Padlocks	X		X	X
410DRED	Lightweight Zenex™ Thermoplastic Safety Padlock	X	X	X	X
420D	Steel Lockout Hasp	X	X	X	X
S2394D	Miniature Circuit Breaker Lockout	X		X	
506D	Grip Tight™ Circuit Breaker Lockout Set	X	X	X	X
487D	Electrical Plug Lockout	X	X	X	X
496BD	Universal Wall Switch Cover	X		X	
S806D	Adjustable Cable Lockout Device	X	X	X	X
480D	Gate Valve Lockout	X	X		X
S3081D	Adjustable Ball Valve Lockout	X	X		X
1334POGKIT	Merchandising Kit, Header, Product Cards and Schematics	X	X	X	X

Planograms include two of each item, a Master Lock header and a set of re-order tags.

All of the carded safety padlocks, devices and tags listed are available for purchase separately to replenish or expand your planogram and enhance your showroom. Carded commercial security products and commercial security planograms are also available.



Professional Lockout Services

Master Lock Professional Lockout Services can take a holistic approach to build a customized, best-in-class lockout management system or focus on the select elements that will make significant improvements in a facility's safety program

Professional Lockout Services

Expert guidance and industry-leading experience to help facilities meet safety goals.



Assessment

Our safety experts conduct in-depth, on-site assessments to evaluate the current state of a lockout tagout program and identify methods of improvement. The recommendations from the assessment can be used to design a best-in-class lockout/tagout program that achieves heightened safety, practicality and efficiency for personnel.



Written Program

A team of safety consultants will develop a company-wide written lockout program that takes an efficient approach to meet and exceed compliance requirements.



Written Procedures

Our technicians complete an in-depth analysis of equipment and energy sources to create detailed lockout isolation procedures.



Tiered Training

We empower organizations to create a safer work environment. Achieving a compliant lockout management system requires ongoing training. Our safety certified staff will come on-site and lead all or any of the hands-on courses requested. We offer the following training courses:

- Authorized Personnel
- Affected Personnel
- Lockout Procedure Creation
- Lockout Practitioner Workshop
- Lockout Leadership



Proper Equipment

Our safety experts can provide recommendations on the necessary safety padlocks, lockout devices, and identification tags for a best-in-class lockout management system.



Access

Experience has shown it should take less than 15 seconds to access lockout equipment. Keeping the necessary equipment close and easily accessible by authorized personnel saves time, eliminates excuses, and helps prevent damages and injuries.



Audits

Our safety experts offer on-site review of lockout procedures and programs to help ensure compliance requirements are met. We deliver a summary report which includes best-practice recommendations and corrective actions.

Estimates for services will be provided once the scope of work has been identified.



Master Lock eLOTO Lockout Procedure Writing Software

Empower employees with the tools needed to make work environments safer

Master Lock eLOTO is an easy-to-use, cloud-based software solution for writing and managing visual lockout procedures. Master Lock eLOTO is comprised of a web interface and two mobile applications:

Lockout Procedure Writing Software

Machine-specific procedures are a requirement of a compliant lockout management system. Master Lock eLOTO provides a best-practice solution to create visual lockout procedures and conduct audits.

Master Lock | **eLOTO**



eLOTO Writer App

- ▶ Collect data right at the machine for each lockout isolation point



eLOTO Procedure Database

- ▶ Use a web browser to create, modify and print lockout procedures, and manage dates and tasks associated with audits



eLOTO Inspector App

- ▶ Audit procedures and authorized personnel at the equipment location

The eLOTO procedure database and the Writer and Inspector mobile applications work together to help ensure lockout procedures are accurate and up-to-date. Printed procedures meet the best-practice format demonstrated in ANSI Z244.1-2016.





Commercial Carded List Prices

Effective November 15, 2019



- Hardened boron alloy shackles for superior cut resistance
- Dual ball bearing locking mechanism resists pulling and prying
- High security cylinder
 - 5-pin and 6-pin cylinder provides tens of thousands of key changes
 - Spool pins are virtually impossible to pick

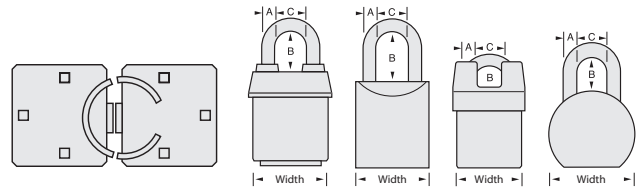

Nos. 770, 6271, 6230, 6321, 6121, 7040 and 6840 Padlocks

ProSeries® Padlocks										
Carded Model Number	Description	Shelf Pack Quantity	Master Carton Quantity	Shackle Dimensions			Shackle Dimensions			Package Size
				A	B	C	A	B	C	W x H
Standard Cylinder Padlocks										
770LHCD	Die Cast Hidden Shackle Padlock and Steel Hasp	–	4	3/8in	–	–	9mm	–	–	11 in x 7in
6271D	2-7/8in (73mm) wide Die Cast Hidden Shackle Padlock	4	12	3/8in	–	–	9mm	–	–	4in x 7in
6230DLH	2-1/2in (64mm) wide Solid Steel Padlock, 2in (51mm) shackle	4	24	7/16in	2in	7/8in	11mm	51mm	22mm	4in x 8in
6321D	2-1/8in (54mm) wide Shrouded Shackle Padlock	4	24	5/16in	3/4in	7/8in	8mm	19mm	22mm	4in x 7in
6121D	2-1/8in (54mm) wide Weather Tough® Padlock	4	24	5/16in	1-1/8in	7/8in	8mm	29mm	22mm	4in x 7in
7040D	1-3/4in (44mm) wide Solid Steel Padlock	4	24	5/16in	1-3/16in	29/32in	8mm	30mm	23mm	4in x 7in
6840D	1-3/4in (44mm) wide Solid Brass Padlock	4	24	5/16in	1-3/16in	29/32in	8mm	30mm	23mm	4in x 7in



- Octagonal boron-carbide shackles provide exceptional cut resistance
- Dead locking mechanism protects against pry, shim and rap attacks
- Shackle seals and dial dust covers protect internal components from dirt and grime
- Stainless steel, brass and die cast bodies withstand the elements. Stainless steel shackles available on select models
- Large, ergonomic dials with blind feature permit operation in low light and complete darkness
- Easily reset – no tool required

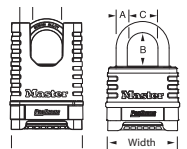

Nos. 1174, 1175, 1177 and 1178 Padlocks

ProSeries® Resetttable Combination Locks										
Carded Model Number	Description	Shelf Pack Quantity	Master Carton Quantity	Shackle Dimensions			Shackle Dimensions			Package Size
				A	B	C	A	B	C	W x H
1174D	2-1/4in (57mm) wide Stainless Steel Body with Round Stainless Steel Shackle	4	24	5/16in	1-1/16in	1in	8mm	28mm	25mm	4in x 7in
1175D	2-1/4in (57mm) wide Brass Body with Octagonal Boron-Carbide Shackle	4	24	3/8in	1-1/16in	15/16in	10mm	28mm	24mm	4in x 7in
1175DLH	2-1/4in (57mm) wide Brass Body with Octagonal Boron-Carbide Shackle	4	24	3/8in	2-1/16in	15/16in	10mm	53mm	24mm	4in x 7in
1177D	2-1/4in (57mm) wide Shrouded Brass Body with Octagonal Boron-Carbide Shackle	4	24	3/8in	2-1/16in	15/16in	10mm	53mm	24mm	4in x 7in
1178D	2-1/4in (57mm) wide Die Cast Body with Octagonal Boron-Carbide Shackle	4	24	3/8in	1-1/16in	15/16in	10mm	28mm	24mm	4in x 7in



- Set-your-own 4-digit combination with easy combination reset – no tool required for 975 model
- Combination reset feature used to restrict/change allowed access
- Reset to any of 10,000 numbers
- Solid case for strength and weatherability
- Heavy hardened shackle provides high resistance to cutting and prying

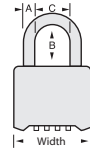

Nos. 975 175 and 178 Padlocks

ProSeries® Resettable Combination Locks										
Carded Model Number	Description	Shelf Pack Quantity	Master Carton Quantity	Shackle Dimensions			Shackle Dimensions			Package Size W x H
				A	B	C	A	B	C	
975DCOM	Set-Your-Own Combination; No Combination Reset Tool Required	4	24	5/16in	1in	1in	8mm	25mm	25mm	3-1/2in x 1-2/9in
975DLHCOM	Set-Your-Own Combination; 2in (51mm) Shackle; No Combination Reset Tool Required	4	24	5/16in	2in	1in	8mm	51mm	25mm	3-1/2in x 1-2/9in
175DCOM	Set-Your-Own Combination	4	24	5/16in	2in	1in	8mm	51mm	25mm	3-1/2in x 1-2/9in
175DLH	Set-Your-Own Combination; 2-1/4in (57mm) Shackle	4	24	5/16in	2-1/4in	1in	8mm	57mm	25mm	3-1/2in x 1-1/4in
178D	Set-Your-Own Combination; Black Powder Coated Zinc Body	4	24	5/16in	1in	1in	8mm	25mm	25mm	3-1/2in x 1-1/4in



- Hardened boron alloy shackles for superior cut resistance – No. 5
- Hardened steel shackles for cut resistance – Nos. 1 and 3
- Dual locking levers provide extra pry resistance
- Hardened steel bottom plates for drill resistance
- Top and bottom bumpers for greater scratch resistance

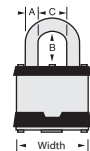

Nos. 5, 1 and 3 Padlocks

Commercial Laminated Padlocks										
Carded Model Number	Description	Shelf Pack Quantity	Master Carton Quantity	Shackle Dimensions			Shackle Dimensions			Package Size W x H
				A	B	C	A	B	C	
5DCOM	2in (51mm) wide Laminated Padlock	4	24	3/8in	1in	5/16in	10mm	25mm	8mm	4in x 7in
5TCOM	2in (51mm) wide Laminated Padlock, 2-Pack	4	16	3/8in	1in	5/16in	10mm	25mm	8mm	8in x 6in
1DCOM	1-3/4in (44mm) wide Laminated Padlock	4	24	5/16in	15/16in	3/4in	8mm	24mm	19mm	4in x 6in
1DLJCOM	1-3/4in (44mm) wide Laminated Padlock w/ 2-1/2in Shackle	4	24	5/16in	2-1/2in	3/4in	8mm	64mm	19mm	8in x 6in
1TRILJCOM	1-3/4in (44mm) wide Laminated Padlock w/ 2-1/2in Shackle, 3-Pack	4	16	5/16in	2-1/2in	3/4in	8mm	64mm	19mm	8in x 7in
3DCOM	1-9/16in (40mm) wide Laminated Padlock	4	24	9/32in	3/4in	5/8in	7mm	19mm	16mm	4in x 6in
3DLHCOM	1-9/16in (40mm) wide Laminated Padlock w/ 2in Shackle	4	24	9/32in	2in	5/8in	7mm	51mm	16mm	4in x 7in
3QCOM	1-9/16in (40mm) wide Laminated Padlock, 4-Pack	4	16	9/32in	3/4in	5/8in	7mm	19mm	16mm	8in x 6in



Commercial Security

PRICE BOOK CONTENTS

TERMS OF SALE	1	Non-Rekeyable Padlocks.....	29
ORDERING INFORMATION.....	1	■ Commercial Magnum® Padlocks	30
SPEED INDEX	3	■ Laminated Steel & Brass Padlocks	31
MASTER LOCK VAULT ENTERPRISE	6	■ Covered Laminated Steel Padlocks	34
BUMPSTOP® ADVANCED CYLINDER		■ Shrouded Laminated Steel Padlocks	35
TECHNOLOGY.....	8	■ Vending & Meter Padlocks	36
Pro Series® Rekeyable Padlocks	9	■ Universal Pin Padlocks & Accessories	38
■ Hidden Shackles Padlocks	10	■ Shrouded Padlocks	38
■ Solid Iron Shrouded Padlocks	11	■ Combination Padlocks	39
■ Solid Steel Padlocks	12	■ Bluetooth® Enabled Products	41
■ Weather Tough® Padlocks	13	■ Warded Padlocks	42
■ Solid Brass Padlocks	14	■ Economy Brass Padlocks	43
Door Key Compatible Cylinders & Padlocks.....	15	Python® Adjustable Locking Cables	44
■ Solid Iron Shrouded Padlocks	16	King Pin Locks	45
■ Solid Steel Padlocks	17	SAFESPACE® Storage Security	
■ Weather Tough® Padlocks	18	■ Key Cabinets	46
■ Solid Brass Padlocks	19	■ Storage Bag	46
Interchangeable Cores & Padlocks	20	■ Lock Boxes	47
■ Solid Iron Shrouded Padlocks	21	■ Key Case	48
■ Solid Steel Padlocks	22	Hasps	49
■ Weather Tough® Padlocks	23	Padlock Eyes & Hasplocks	50
■ Solid Brass Padlocks	24	Government Locks	51
Pro Series® Resettable Combination Padlocks ..	25	Services	52
Rekeyable Padlocks.....	26	Service Parts & Accessories	53
■ Die Cast Zinc Padlocks	27	■ Padlock Cylinders	53
■ Laminated Steel Pin Tumbler	28	■ Duplicate Keys	54
		■ Key Blanks	55
		■ Service Parts	57

SPEED INDEX

Product Number	Page Number	Shelf Pack Quantity	Master Carton Quantity
1	32	6	24
1KA	32	6	24
1LF	32	6	24
1LJ	32	6	24
1LN	32	6	24
1UP	38	6	24
1UPLJ	38	6	24
2	32	6	24
2KA	32	6	24
2LF	32	6	24
2LJ	32	6	24
2LN	32	6	24
3	33	6	24
3KA	33	6	24
3LF	33	6	24
3LH	33	6	24
3UP	38	6	24
3UPLF	38	6	24
4	33	6	24
4KA	33	6	24
4LH	33	6	24
5	31	6	24
5KA	31	6	24
5LF	31	6	24
5LJ	31	6	24
5UP	38	6	24
5UPLF	38	6	24
6	31	6	24
6KA	31	6	24
7	36	6	24
7KA	36	6	24
7LF	36	6	24
7LJ	36	6	24
8	36	6	24
8KA	36	6	24
8LF	36	6	24
8LJ	36	6	24
10D	42	4	24
10KA	42	12	144
21	28	6	24
21KA	28	6	24
21LF	28	6	24
21LJ	28	6	24
21LN	28	6	24
22	42	12	72
22D	42	4	24
22KA	42	12	72
22KALF	42	6	36

Product Number	Page Number	Shelf Pack Quantity	Master Carton Quantity
22T	42	4	16
25	28	6	24
25KA	28	6	24
25LF	28	6	24
25LJ	28	6	24
31	33	6	24
31KA	33	6	24
31LH	33	6	24
37	35	6	24
37KA	35	6	24
40KADPF	38	6	36
60	50	12	72
60R	50	6	72
81	32	6	24
81KA	32	6	24
81LF	32	6	24
81LJ	32	6	24
82	32	6	24
82KA	32	6	24
82LF	32	6	24
82LJ	32	6	24
101	28	5	20
101KA	28	5	20
105D	42	4	24
105KA	42	12	72
175	39	6	36
175LH	39	6	36
175LHSS	39	6	36
176	39	6	36
176KA	39	6	36
176KALH	39	6	36
176LH	39	6	36
178BLK	39	6	36
207D	48	4	24
220	27	5	30
220KA	27	5	30
220LH	27	5	20
230	28	5	20
230KA	27	5	20
230LH	27	5	20
291	58	—	1
311	34	6	24
311KA	34	6	24
311LF	34	6	24
311LH	34	6	24
312	34	6	24
312KA	34	6	24
312LF	34	6	24

NOTE: Speed Index does not include all products. See individual product pages for complete listing.

SPEED INDEX

Product Number	Page Number	Shelf Pack Quantity	Master Carton Quantity
312LH	34	6	24
315	34	6	24
315KA	34	6	24
315LF	34	6	24
315LH	34	6	24
376	38	—	36
387	45	—	1
387KA	45	—	1
443LE	37	6	24
450D	50	4	24
500	42	12	72
500D	42	4	24
500KA	42	12	72
500KABRK	42	12	72
510D	42	4	24
510KAD	42	4	24
517D	42	4	24
517KAD	42	4	24
720DPF	49	4	24
722DPF	49	4	24
730DPF	49	6	24
731	49	6	24
732	49	6	24
770	49	—	12
770LHC	10/49	—	6
878	39	6	36
975	39	6	36
975LH	39	6	36
1174	25	4	24
1175	25	4	24
1175LH	25	4	24
1175LHSS	25	4	24
1175LHRS	25	4	24
1175RS	25	4	24
1177	25	4	24
1178	25	4	24
1500	40	12	72
1500KA	40	12	72
1500LF	40	6	36
1500LH	40	6	36
3009D	42	4	16
3630	40	—	25
3631	40	—	25
3670	40	—	25
4120	43	12	72
4120KA	43	12	72
4130	43	12	72

Product Number	Page Number	Shelf Pack Quantity	Master Carton Quantity
4130KA	43	12	72
4130KALF	43	12	72
4140	43	12	72
4140KA	43	12	72
4140KALH	43	12	72
4140LH	43	12	72
4150	43	6	72
4150KA	43	6	72
4150KALJ	43	6	72
4150LJ	43	6	72
4400ENT	7/41	2	8
4401LHENT	7/41	2	8
5400D	48	—	4
5401D	48	—	4
5406D	48	2	4
5420D	47	—	4
5422D	47	—	4
5423D	47	—	4
5424D	47	—	4
5425D	47	—	4
5440ENT	7/41	1	2
5441ENT	7/41	1	2
6121	13	6	24
6121KA	13	6	24
6121LF	13	6	24
6121LJ	13	6	24
6125	13	6	24
6125KA	13	6	24
6125LJ	13	6	24
6127	13	6	24
6127KA	13	6	24
6127LH	13	6	24
6127LJ	13	6	24
6230	12	6	24
6230KA	12	6	24
6230LH	12	6	24
6271	10	—	12
6271KA	10	—	12
6321	11	6	24
6321KA	11	6	24
6325	11	6	24
6325KA	11	6	24
6327	11	6	24
6327KA	11	6	24
6421WO series	23	6	24
6421LFWO series	23	6	24
6421LJWO series	23	6	24

SPEED INDEX

Product Number	Page Number	Shelf Pack Quantity	Master Carton Quantity
6427WO series	23	6	24
6427LHWO series	23	6	24
6427LJWO series	23	6	24
6440ENT	7/41	4	24
6521WO series	21	6	24
6527WO series	21	6	24
6621WO series	18	6	24
6621LFWO series	18	6	24
6621LJWO series	18	6	24
6627WO series	18	6	24
6627LHWO series	18	6	24
6627LJWO series	18	6	24
6721WO series	16	6	24
6727WO series	16	6	24
6830	14	6	24
6830KA	14	6	24
6830LF	14	6	24
6840	14	6	24
6840KA	14	6	24
6840LF	14	6	24
6840LJ	14	6	24
6841WO series	24	6	24
6841LFWO series	24	6	24
6841LJWO series	24	6	24
6842WO series	19	6	24
6842LFWO series	19	6	24
6842LJWO series	19	6	24
6850	14	6	24
6850KA	14	6	24
6850LJ	14	6	24
6851WO series	24	6	24
6851LJWO series	24	6	24
6852WO series	19	6	24
6852LJWO series	19	6	24
7030	12	6	24
7030KA	12	6	24
7030LF	12	6	24
7035	12	6	24
7035KA	12	6	24
7040	12	6	24
7040KA	12	6	24
7040LF	12	6	24
7040LJ	12	6	24
7041WO series	22	6	24

Product Number	Page Number	Shelf Pack Quantity	Master Carton Quantity
7041LFWO series	22	6	24
7041LJWO series	22	6	24
7042WO series	17	6	24
7042LJWO series	17	6	24
7045	12	6	24
7045KA	12	6	24
7046WO series	22	6	24
7047WO series	17	6	24
7050	12	6	24
7050KA	12	6	24
7050LJ	12	6	24
7051WO series	22	6	24
7051LJWO series	22	6	24
7052WO series	17	6	24
7052LJWO series	17	6	24
7116D	46	—	10
7117D	46	—	10
7120D	46	—	6
7125D	46	—	4
7126D	46	—	4
8413CBL6	44	—	6
8413DPF	44	—	6
8413KACBL6	44	—	6
8417D	44	—	4
8418D	44	—	4
8418KADCAMO-TMB	44	—	4
8419DPF	44	—	4
8428DPS	44	—	6
K3630	40	—	—
MLLOCKSIGN	51	—	—
M1STS	30	6	24
M1KASTS	30	6	24
M1KALFSTS	30	6	24
M1KALJSTS	30	6	24
M1LFSTS	30	6	24
M1LJSTS	30	6	24
M5STS	30	6	24
M5KASTS	30	6	24
M5KALFSTS	30	6	24
M5KALJSTS	30	6	24
M5LFSTS	30	6	24
M5LJSTS	30	6	24
Government Locks	51		
Service Parts	53-61		

ACCESS MANAGEMENT SOLUTIONS: MASTER LOCK® VAULT ENTERPRISE

Smart. Simple. Secure.

The Master Lock Vault Enterprise software and suite of Bluetooth® enabled hardware provide business users who manage many locks and many users with a convenient way to control access, oversee assets and improve accountability. This proven security innovation eliminates the cost, security risk and complexity of physical keys.



INNOVATIVE FEATURES:

- Efficiently manage access to ensure the right users have the right access
- Simplify security set-up with bulk user uploads and fast lock scanning for registration
- Automatically map lock and lock box locations via smartphone
- Easily monitor access with robust data and audit trails
- Assured back-up entry method using manual, directional or numeric code on locks and lockboxes
- Leverage the security of 256-bit, military-grade encryption



Flexible Asset Management

Whether it's one lock or thousands, Master Lock Vault Enterprise provides businesses with unmatched security, simplicity and accountability.

INDIVIDUAL

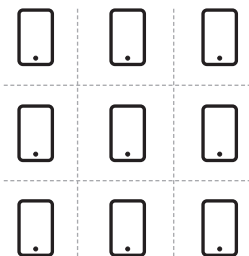

Share permanent or temporary access with our app that turns smartphones into smart keys.

GROUP

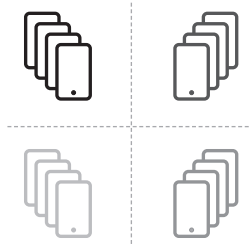

Easily assign users and devices to unique access groups, on demand.

CUSTOMIZED

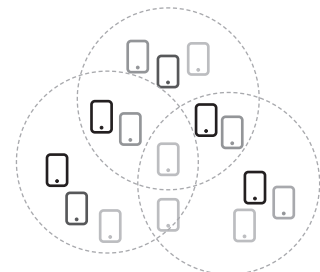

Enjoy system-wide customization, including the ability to overlay groups for efficient access management.

Around-the-Clock Access with Master Lock Vault Enterprise

Integrated into the suite of Bluetooth enabled products, the easy-to-use Master Lock Vault Enterprise app eliminates the need for physical keys and key management, lowering costs and enhancing security. Users view detailed lock-use history, including unlock/open/relock activity.

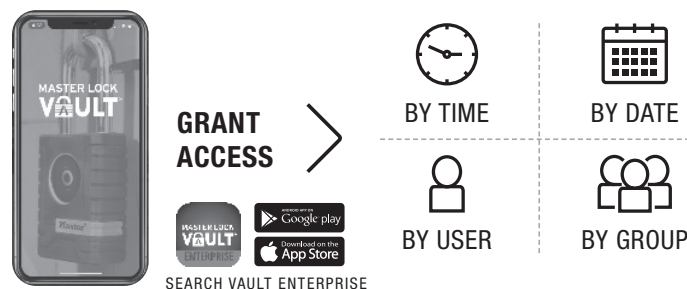

Bluetooth Enabled Products

The Master Lock Vault Enterprise suite of Bluetooth enabled products can be mixed and matched to fit your application needs.

- No keys to lose ■ No combinations to forget ■ No unauthorized key duplication
- No long-term contracts ■ No monthly fees ■ No shared access fees
- Durable, reliable padlocks that feature anti-shim technology for maximum security
- Strong, weather-resistant lock boxes have a large storage capacity for keys and key cards
- Door controller easily wires into electric strikes or magnetic locks and fits inside standard door frames.

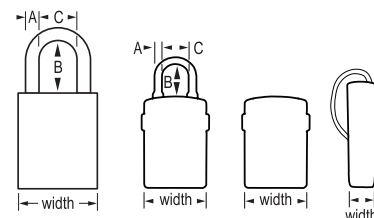
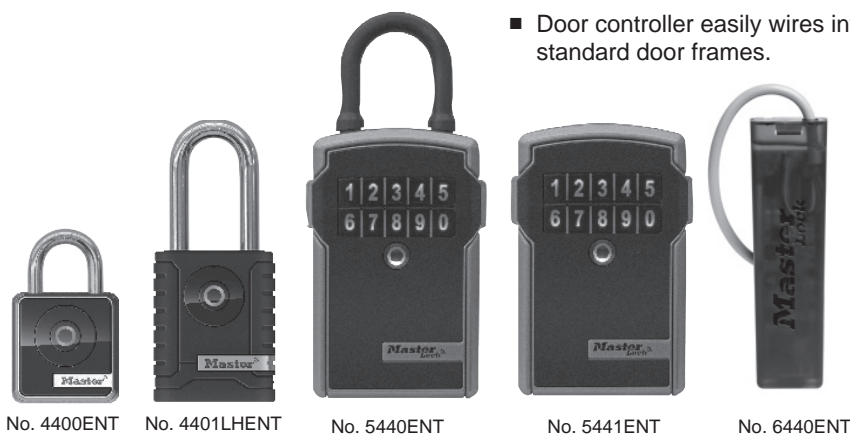

Bluetooth® Enabled Products

Commercial Boxed Products

Product Number	Description	Shelf Pack Quantity	Master Carton Quantity	Shackle Dimensions			Shackle Dimensions (Metric)		
				A	B	C	A	B	C
Bluetooth Padlocks									
4400ENT	Indoor Bluetooth Padlock, 1-29/32in (47mm) wide body	2	8	9/32in	7/8in	13/16in	7mm	22mm	20mm
4401LHENT	Outdoor Bluetooth Padlock, 2-7/32in (56mm) wide body, 2in (51mm) Shackle	2	8	11/32in	2in	15/16in	9mm	51mm	23mm
Bluetooth Lockboxes									
5440ENT	Bluetooth® Portable Lock Box, 3-1/4in (83mm) wide	1	2	13/32in	1-13/16in	1-13/32in	10mm	46mm	36mm
5441ENT	Bluetooth® Wall Mount Lock Box, 3-1/4in (83mm) wide	1	2	NA	NA	NA	NA	NA	NA
Bluetooth Door Controller									
6440ENT	Bluetooth® Door Controller, 1-13/32in (36mm) wide	4	24	NA	NA	NA	NA	NA	NA



Advanced Cylinder Technology



Reverse Rake
Tapered
Driver Pin



High
Performance
Spring

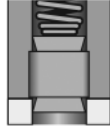

Precision
Cylinder
Chamber

Lock Bumping –

Lock Bumping has become a legitimate security threat as information on the topic has become widely exposed in the news media and on the internet.

In response to this threat, The Master Lock Company developed exclusive patent-pending BumpStop® Advanced Technology that prevents the transfer of force from the bump key to the pins and blocks rotation of the cylinder. With a reverse rake tapered driver pin, high performance spring and precision tolerance chamber, our 4, 5 and 6-pin BumpStop® products resist bump attacks.

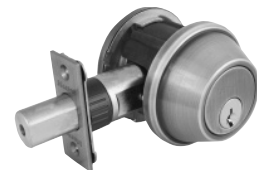
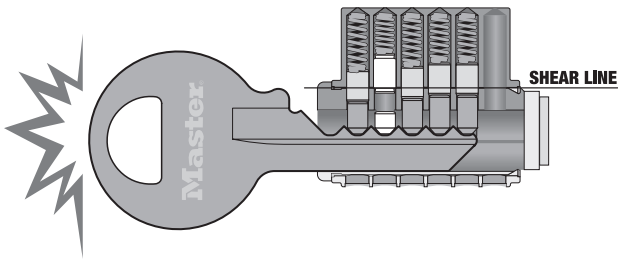

Pro Series® Rekeyable Padlocks

- Hardened boron alloy shackles for superior cut resistance
- Dual ball bearing locking mechanism resists pulling and prying
- High security cylinder
 - 5-pin & 6-pin cylinders provide tens of thousands of key changes
 - Spool pins are virtually impossible to pick
- Rekeyable – replaceable cylinder and shackle

Hidden Shackle Padlocks

- Ideal for vans, trucks, gates and vending
- Greatest physical security - defy bolt cutters and prying
- Die cast body reinforced with anti-saw pins (No. 6271)



6271

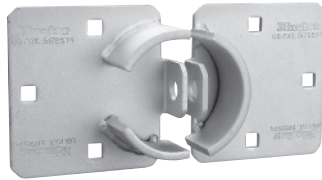

770

High Security Hasp available for Hidden Shackle Lock (Model 6271)

High Security – Solid Iron Shroud

- Heavy steel bodies withstand physical attacks
- Iron shroud protects shackle from cutting and prying



6327

6325

Weather Tough®

- Ideal for harsh outdoor conditions
 - Exclusive cover protects lock from water, ice, dirt and grime
 - Heavy duty steel bodies withstand physical attacks
 - Keyway cover keeps out dust and dirt
- Optional brass shackles available for increased corrosion resistance



6121



6127

High Security – Solid Steel

- Heavy case hardened steel body
- Chrome rustproofing provides longer life
- Shrouded models protect against bolt cutters and prying



7030

7050

7045

Solid Brass

- Body provides extra corrosion resistance in caustic, corrosive salty environments
- Optional brass shackles available for increased corrosion resistance



6850



6830

Pro Series® Rekeyable Padlocks — Hidden Shackle Products

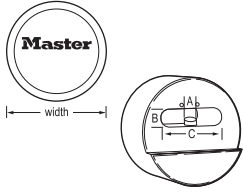

Example	6271 KA WP6
----------------	-------------

Base Model	Description
6271	2-7/8in (73mm) wide Reinforced Die Cast body, Boron Shackle, A = 3/8in (9mm) dia., B = 1-9/32in (15mm), C = 1-23/32in (43mm) – Shelf Pack = NA, Master Carton = 12
770LHC	2-7/8in (73mm) 6271 Die Cast Padlock and 770 Steel Hasp Shelf Pack = NA, Master Carton = 6



BumpStop® Cylinder Technology	
N	Anti-Bump Cylinder Technology (Not available with WO & WCS Option or UN & KZ Option)

Keying	Standard: Keyed Different
UN	Uncombined (Zero bitted cylinder & no keys) - Available with WP6 & WP4 options only
KZ	Zero-Bitted (Not Available with WP option)
KA	Keyed Alike
MK	Keyed Different; Master Keyed
KAMK	Keyed Alike; Master Keyed

Cylinder	Standard: 6-pin W7000 cylinder
WCS	Lock Body only
W6000	5-pin W6000 cylinder
W600A	5-pin American Lock® W600A cylinder (Available as KA & KZ only)
W700A	6-pin American Lock® W700A cylinder (Available as KA & KZ only)
WP4	Edge® Key Control 4-pin cylinder. Standard: Nickel Silver Keys
WP6	Edge® Key Control 6-pin cylinder. Standard: Nickel Silver Keys

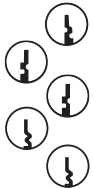

Number of Keys	Standard: 2 keys per lock
1KEY	1 key per lock
3KEY	3 keys per lock
4KEY	4 keys per lock
NOKEY	0 keys per lock

Pro Series® Rekeyable Padlocks — High Security – Solid Iron Shroud

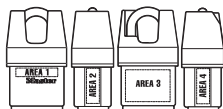
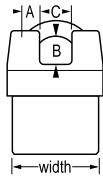

Example 6327 KAMK NR W7000 LZ1 1KEY

Base Model	Description
6327	2-5/8in (67mm) wide body with Boron shackle, A = 7/16in (11mm) dia., B = 3/4in (19mm), C = 7/8in (22mm)
6325	2-3/8in (61mm) wide body with Boron shackle, A = 3/8in (10mm) dia., B = 3/4in (19mm), C = 7/8in (22mm)
6321	2-1/8in (54mm) wide body with Boron shackle, A = 5/16in (8mm) dia., B = 3/4in (19mm), C = 7/8in (22mm)

BumpStop® Cylinder Technology	
N	Anti-Bump Cylinder Technology (Not available with WO & WCS Option or UN & KZ Option)

Keying	Standard: Keyed Different
UN	Uncombined (Zero bitted cylinder & no keys) - Available with WP6 & WP4 options only
KZ	Zero-Bitted (Not Available with WP option)
KA	Keyed Alike
MK	Keyed Different; Master Keyed
KAMK	Keyed Alike; Master Keyed

Function	Standard: Non-Key Retaining
NR	Non-Removable Key

Cylinder	Standard: 5-pin W6000 cylinder
WO	Lock without cylinder
WCS	Lock Body only
W1	4-pin W1 cylinder
W15	5-pin W15 cylinder
W17	5-pin W17 cylinder
W27	5-pin W27 cylinder
W81	5-pin W81 cylinder
W7000	6-pin W7000 cylinder
W7000NISI	6-pin W7000 cylinder with Nickel Silver Key
W600A	5-pin American Lock® W600A cylinder (Available as KA & KZ only)
W700A	6-pin American Lock® W700A cylinder (Available as KA & KZ only)
WP4	Edge® Key Control 4-pin cylinder. Standard: Nickel Silver Keys
WP6	Edge® Key Control 6-pin cylinder. Standard: Nickel Silver Keys

Custom Marking	
LZ1	Laser engraved in 1 area
LZ2	Laser engraved in 2 areas
LZ3	Laser engraved in 3 areas
LZ4	Laser engraved in 4 areas

Number of Keys	Standard: 2 keys per lock
1KEY	1 key per lock
3KEY	3 keys per lock
4KEY	4 keys per lock
NOKEY	0 keys per lock

Pro Series® Rekeyable Padlocks — Solid Steel

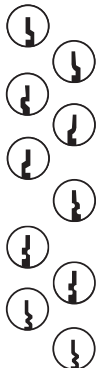
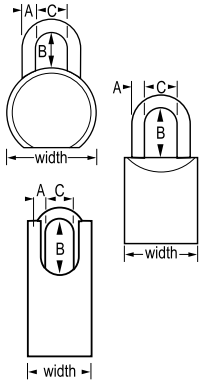

Example	6230 LH
Base Model	Description
6230	2-1/2in (64mm) wide Round body, A = 7/16in (11mm) dia., B = 1-1/8in (29mm), C = 7/8in (22mm)
7050	2in (51mm) wide body, A = 3/8in (9mm) dia., B = 1-1/2in (37mm), C = 29/32in (23mm)
7040	1-3/4in (44mm) wide body, A = 5/16in (8mm) dia., B = 1-3/16in (30mm), C = 29/32in (23mm)
7030	1-9/16in (40mm) wide body, A = 1/4in (6mm) dia., B = 1-1/16in (27mm), C = 25/32in (20mm)
7045	1-3/4in (44mm) wide Shrouded body, A = 5/16in (8mm) dia., B = 1-3/16in (30mm), C = 29/32in (23mm)
7035	1-9/16in (40mm) wide Shrouded body, A = 1/4in (6mm) dia., B = 1-1/16in (27mm), C = 25/32in (20mm)
BumpStop® Cylinder Technology	
N	Anti-Bump Cylinder Technology (Not available with WO & WCS Option or UN & KZ Option)
Keying	Standard: Keyed Different
UN	Uncombined (Zero bitted cylinder & no keys) - Available with WP6 & WP4 Options Only
KZ	Zero-Bitted (Not Available with WP option)
KA	Keyed Alike
MK	Keyed Different; Master Keyed
KAMK	Keyed Alike; Master Keyed
Shackle	Standard: Boron
LF	Boron, B = 1-9/16in (40mm) (7030 & 7040 option only)
LH	Boron, B = 2in (51mm) (6230 option only)
LJ	Boron, B = 2-7/16in (61mm) (7040 & 7050 option only)
Chain	
CN	#40 Sash Chain, 9in (23cm) Long, Zinc Plated (6230, 7050, 7040 & 7030 option only)
Function	Standard: Non-Key Retaining
NR	Non-Removable Key
Cylinder	Standard: 5-pin W6000 cylinder
WO	Lock without cylinder
WCS	Lock Body only
W1	4-pin W1 cylinder
W15	5-pin W15 cylinder
W17	5-pin W17 cylinder
W27	5-pin W27 cylinder
W81	5-pin W81 cylinder
W7000	6-pin W7000 cylinder
W7000NISI	6-pin W7000 cylinder with Nickel Silver Key
W600A	5-pin American Lock® W600A cylinder (Available as KA & KZ only)
W700A	6-pin American Lock® W700A cylinder (Available as KA & KZ only)
WP4	Edge® Key Control 4-pin cylinder. Standard: Nickel Silver Keys
WP6	Edge® Key Control 6-pin cylinder. Standard: Nickel Silver Keys
Number of Keys	Standard: 2 keys per lock
1KEY	1 key per lock
3KEY	3 keys per lock
4KEY	4 keys per lock
NOKEY	0 keys per lock

KEY BLANKS: See pages 54-55 for respective key blanks or cut key information.

PP Unless otherwise specified, Shelf Pack = 6, Master Carton = 24 PP

Pro Series® Rekeyable Padlocks — Weather Tough®

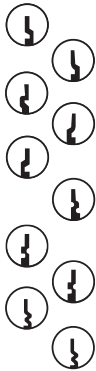
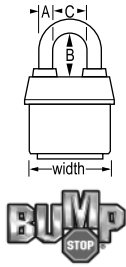

Example	6121 KA LF WP6
Base Model	Description
6127	2-5/8in (67mm) wide body, A = 7/16in (11mm) dia., B = 1-3/8in (35mm), C = 7/8in (22mm)
6125	2-3/8in (61mm) wide body, A = 3/8in (10mm) dia., B = 1-3/8in (35mm), C = 7/8in (22mm)
6121	2-1/8in (54mm) wide body, A = 5/16in (8mm) dia., B = 1-1/8in (29mm), C = 7/8in (22mm)
BumpStop® Cylinder Technology	
N	Anti-Bump Cylinder Technology (<i>Not available with WO & WCS Option or UN & KZ Option</i>)
Keying	Standard: Keyed Different
UN	Uncombined (Zero bitted cylinder & no keys) - <i>Available with WP6 & WP4 Options Only</i>
KZ	Zero-Bitted (<i>Not Available with WP option</i>)
KA	Keyed Alike
MK	Keyed Different; Master Keyed
KAMK	Keyed Alike; Master Keyed
Shackle	Standard: Boron
LF	Boron, B = 1-1/2in (38mm) (<i>6121 option only</i>)
LH	Boron, B = 1-7/8in (48mm) (<i>6127 option only</i>)
LJ	Boron, B = 2-1/2in (64mm) (<i>6127 & 6121: B = 2-3/8in (60mm)</i>)
Chain	
CN	#40 Sash Chain, 9in (23cm) Long, Zinc Plated
Function	Standard: Non-Key Retaining
NR	Non-Removable Key
Cylinder	Standard: 5-pin W6000 cylinder
WO	Lock without cylinder
WCS	Lock Body only
W1	4-pin W1 cylinder
W15	5-pin W15 cylinder
W17	5-pin W17 cylinder
W27	5-pin W27 cylinder
W81	5-pin W81 cylinder
W7000	6-pin W7000 cylinder
W7000NISI	6-pin W7000 cylinder with Nickel Silver Key
W600A	5-pin American Lock® W600A cylinder (<i>Available as KA & KZ only</i>)
W700A	6-pin American Lock® W700A cylinder (<i>Available as KA & KZ only</i>)
WP4	Edge® Key Control 4-pin cylinder. Standard: Nickel Silver Keys
WP6	Edge® Key Control 6-pin cylinder. Standard: Nickel Silver Keys
Body Color	Standard: Black body.
RED – Red; YLW – Yellow; GRN – Green; BLU – Blue; ORJ – Orange; WHT – White (<i>6121 option only</i>)	
Custom Marking	
LZ1	Laser engraved in 1 area
LZ2	Laser engraved in 2 areas
LZ3	Laser engraved in 3 areas
LZ4	Laser engraved in 4 areas
Number of Keys	Standard: 2 keys per lock
1KEY	1 key per lock
3KEY	3 keys per lock
4KEY	4 keys per lock
NOKEY	0 keys per lock

KEY BLANKS: See pages 54-55 for respective key blanks or cut key information.

PP Unless otherwise specified, Shelf Pack = 6, Master Carton = 24 PP

Pro Series® Rekeyable Padlocks — Solid Brass

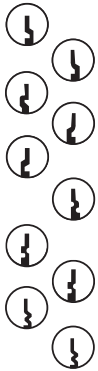
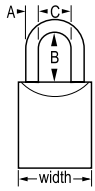







Example	6850 KA B NR LZ1
Base Model	Description
6850	2in (51mm) wide body, A = 3/8in (9mm) dia., B = 1-1/2in (37mm), C = 29/32in (23mm)
6840	1-3/4in (44mm) wide body, A = 5/16in (8mm) dia., B = 1-3/16in (30mm), C = 29/32in (23mm)
6830	1-9/16in (40mm) wide body, A = 1/4in (6mm) dia., B = 1-1/16in (27mm), C = 25/32in (20mm)
BumpStop® Cylinder Technology	
N	Anti-Bump Cylinder Technology (Not available with WO & WCS Option or UN & KZ Option)
Keying	
	Standard: Keyed Different
UN	Uncombined (Zero bitted cylinder & no keys) - Available with WP6 & WP4 Options Only
KZ	Zero-Bitted (Not Available with WP option)
KA	Keyed Alike
MK	Keyed Different; Master Keyed
KAMK	Keyed Alike; Master Keyed
Shackle	
	Standard: Boron
LF	Boron, B = 1-9/16in (40mm) (6830 & 6840 option only)
LJ	Boron, B = 2-1/2in (64mm) (6850 option only), B = 2-7/16in (61mm) (6840 option only)
Chain	
CN	#40 Sash Chain, 9in (23cm) Long, Zinc Plated
Function	
	Standard: Non-Key Retaining
NR	Non-Removable Key
Cylinder	
	Standard: 5-pin W6000 cylinder
WO	Lock without cylinder
WCS	Lock Body only
W1	4-pin W1 cylinder
W15	5-pin W15 cylinder
W17	5-pin W17 cylinder
W27	5-pin W27 cylinder
W81	5-pin W81 cylinder
W7000	6-pin W7000 cylinder
W7000NISI	6-pin W7000 cylinder with Nickel Silver Key
W600A	5-pin American Lock® W600A cylinder (Available as KA & KZ only)
W700A	6-pin American Lock® W700A cylinder (Available as KA & KZ only)
WP4	Edge® Key Control 4-pin cylinder. Standard: Nickel Silver Keys
WP6	Edge® Key Control 6-pin cylinder. Standard: Nickel Silver Keys
Custom Marking	
LZ1	Laser engraved in 1 area
LZ2	Laser engraved in 2 areas
LZ3	Laser engraved in 3 areas
LZ4	Laser engraved in 4 areas
Number of Keys	
	Standard: 2 keys per lock
1KEY	1 key per lock
3KEY	3 keys per lock
4KEY	4 keys per lock
NOKEY	0 keys per lock

Door Key Compatible Cylinders & Padlocks

Same Key Opens Both



- Use the same key that opens your security doors – Improve key control • Security • Convenience • Safety
- Cylinders may be ordered both as part of a complete American Lock® Door Key Compatible padlock assembly, or separately, keyed up and ready to plug into your system
- Padlock bodies will also accept the following OEM cylinders: Medeco® #20W20000 6-pin cylinder, Schlage® (6-pin Key-in-Knob), Assa® (65611), Schlage® Primus® & GMS® cylinders

Cylinder Options		
D12 Kwikset® (composite)		
D04 Schlage® C		
D03 Yale® 8		

Pro Series® Door Key Compatible Padlocks

- Hardened boron alloy shackles for superior cut resistance
- Dual ball bearing locking mechanism resists pulling and prying
- Rekeyable – replaceable cylinder and shackle

High Security – Solid Iron Shroud

- Heavy steel bodies withstand physical attacks
- Iron shroud protects shackle from cutting and prying



Weather Tough®

- Ideal for harsh outdoor conditions
 - Exclusive cover protects lock from water, ice, dirt and grime
 - Heavy duty steel bodies withstand physical attacks
 - Keyway cover keeps out dust and dirt
- Optional brass shackles available for increased corrosion resistance



High Security – Solid Steel

- Heavy case hardened steel body
- Chrome rustproofing provides longer life
- Shrouded models protect against bolt cutters and prying



Solid Brass

- Body provides extra resistance in caustic, corrosive and salty environments
- Optional brass shackle available for increased corrosion resistance



Pro Series® Door Key Compatible Cylinders & Padlocks — High Security — Solid Iron Shroud

Example	6727 D045 MK LZ1 NOKEY
	D04 5 KZ
	6721 WO

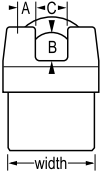

Base Model	Description
6727	2-5/8in (67mm) wide body, Boron Shackle, A = 7/16in (11mm) dia., B = 3/4in (19mm), C = 7/8in (22mm)
6721	2-1/8in (54mm) wide body, Boron Shackle, A = 5/16in (8mm) dia., B = 3/4in (19mm), C = 7/8in (22mm)

Function	Standard: Non-Key Retaining
NR	Non-Removable Key

Cylinder	Description
WO	Lock without cylinder
WCS	Lock Body only
D12	Kwikset® (composite)*
D04	Schlage® C
D03	Yale® 8

**Exclusively available as 5-pin cylinder*

Note: 1) When ordering cylinders only, put an "A" prefix in front of the cylinder number to assure correct cylinder drivers are provided.
2) Cylinder Only Packaging: Shelf Pack = 6, Master Carton = 24

No. of Pins	Description
5	5 Pins
6	6 Pins

Keying	Standard: Keyed Different
KZ	Zero-Bitted
KA	Keyed Alike
MK	Keyed Different; Master Keyed
KAMK	Keyed Alike; Master Keyed

Custom Marking	Description
LZ1	Laser engraved in 1 area
LZ2	Laser engraved in 2 areas
LZ3	Laser engraved in 3 areas
LZ4	Laser engraved in 4 areas

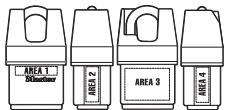

Number of Keys	Standard: 2 keys per lock
1KEY	1 key per lock
3KEY	3 keys per lock
4KEY	4 keys per lock
NOKEY	0 keys per lock

Pro Series® Key-in-Knob Cylinders & Padlocks — Solid Steel

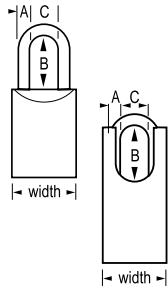

Example	7052 D12 5 KA
	D04 6
	7042 LJ WO

Base Model	Description
7052	2in (51mm) wide body, A = 3/8in (9mm) dia., B = 1-1/2in (37mm), C = 29/32in (23mm), Boron
7042	1-3/4in (44mm) wide body, A = 5/16in (8mm) dia., B = 1-3/16in (30mm), C = 29/32in (23mm)
7047	1-3/4in (44mm) Shrouded wide body, A = 5/16in (8mm) dia., B = 1-3/16in (30mm), C = 29/32in (23mm)

Shackle	
LJ	Boron, B = 2-1/2in (64mm) (7052 & 7042 Option only)

Chain	
CN	#40 Sash Chain, 9in (23cm) Long, Zinc Plated (7047 & 7042 Option only)

Cylinder	
WO	Lock without cylinder
WCS	Lock Body only
D12	Kwikset® (composite)*
D04	Schlage® C
D03	Yale® 8
*Exclusively available as 5-pin cylinder	
Note: 1) When ordering cylinders only, put an "A" prefix in front of the cylinder number to assure correct cylinder drivers are provided. 2) Cylinder Only Packaging: Shelf Pack = 6, Master Carton = 24	

No. of Pins	
5	5 Pins
6	6 Pins

Keying	
Standard: Keyed Different	
KZ	Zero-Bitted
KA	Keyed Alike
MK	Keyed Different; Master Keyed
KAMK	Keyed Alike; Master Keyed

Number of Keys	
Standard: 2 keys per lock	
1KEY	1 key per lock
3KEY	3 keys per lock
4KEY	4 keys per lock
NOKEY	0 keys per lock

Pro Series® Key-in-Knob Cylinders & Padlocks — Weather Tough®

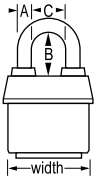

Example	6627 LH D04 5 KAMK LZ1 1KEY
	D04 6
	6621 WO

Base Model	Description
6627	2-5/8in (67mm) wide body, A = 7/16in (11mm) dia., B = 1-3/8in (35mm), C = 7/8in (22mm)
6621	2-1/8in (54mm) wide body, A = 5/16in (8mm) dia., B = 1-1/8in (29mm), C = 7/8in (22mm)

Shackle	Standard: Boron
LF	Boron, B = 1-1/2in (38mm) (6621 option only)
LH	Boron, B = 1-7/8in (48mm) (6627 option only)
LJ	Boron, B = 2-1/2in (64mm) (6627: B = 2-3/8in (60mm))



Chain	
CN	#40 Sash Chain, 9in (23cm) Long, Zinc Plated

Function	Standard: Non-Key Retaining
NR	Non-Removable Key

Cylinder	
WO	Lock without cylinder
WCS	Lock Body only
D12	Kwikset® (composite)*
D04	Schlage® C
D03	Yale® 8
*Exclusively available as 5-pin cylinder	
Note: 1) When ordering cylinders only, put an "A" prefix in front of the cylinder number to assure correct cylinder drivers are provided. 2) Cylinder Only Packaging: Shelf Pack = 6, Master Carton = 24	

No. of Pins	
5	5 Pins
6	6 Pins

Keying	Standard: Keyed Different
KZ	Zero-Bitted
KA	Keyed Alike
MK	Keyed Different; Master Keyed
KAMK	Keyed Alike; Master Keyed



Custom Marking	
LZ1	Laser engraved in 1 area
LZ2	Laser engraved in 2 areas
LZ3	Laser engraved in 3 areas
LZ4	Laser engraved in 4 areas

Number of Keys	Standard: 2 keys per lock
1KEY	1 key per lock
3KEY	3 keys per lock
4KEY	4 keys per lock
NOKEY	0 keys per lock

Pro Series® Key-in-Knob Cylinders & Padlocks — Solid Brass

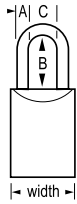

Example	6852 CN D04 6 KAMK LZ1 1KEY
	D03 5 KZ
	6842 LJ WO

Base Model	Description
6852	2in (51mm) wide body, A = 3/8in (9mm) dia., B = 1-1/2in (37mm), C = 29/32in (23mm)
6842	1-3/4in (44mm) wide body, A = 5/16in (8mm) dia., B = 1-3/16in (30mm), C = 25/32in (20mm)

Shackle	Standard: Boron
LF	Boron, B = 1-1/2in (38mm) (6842 option only)
LJ	Boron, B = 2-1/2in (64mm)

Chain	
CN	#40 Sash Chain, 9in (23cm) Long, Zinc Plated

Cylinder	
WO	Lock without cylinder
WCS	Lock Body only
D12	Kwikset® (composite)*
D04	Schlage® C
D03	Yale® 8

*Exclusively available as 5-pin cylinder

Note: 1) When ordering cylinders only, put an "A" prefix in front of the cylinder number to assure correct cylinder drivers are provided.
2) Cylinder Only Packaging: Shelf Pack = 6, Master Carton = 24

No. of Pins	
5	5 Pins
6	6 Pins

Keying	Standard: Keyed Different
KZ	Zero-Bitted
KA	Keyed Alike
MK	Keyed Different; Master Keyed
KAMK	Keyed Alike; Master Keyed

Custom Marking	
LZ1	Laser engraved in 1 area
LZ2	Laser engraved in 2 areas
LZ3	Laser engraved in 3 areas
LZ4	Laser engraved in 4 areas

Number of Keys	Standard: 2 keys per lock
1KEY	1 key per lock
3KEY	3 keys per lock
4KEY	4 keys per lock
NOKEY	0 keys per lock

All marks are registered trademarks of their respective owners.

Small Format Interchangeable Cores & Pro Series® Padlocks



- Padlock bodies will also accept the following standard size OEM cores: Best®, Best® PKS®, Arrow®, Falcon®, Kaba® Peaks®, KSP® & Lori®
- Standard SFIC with the CY keyway may be ordered both as part of a complete Master Lock IC padlock assembly, or separately, keyed up and ready to plug into your system



Pro Series® Small Format Interchangeable Core Padlocks

- Hardened boron alloy shackles for superior cut resistance
- Dual ball bearing locking mechanism resists pulling and prying
- Rekeyable — replaceable cylinder and shackle

High Security –

Solid Iron Shroud

- Greatest physical security available
 - Heavy steel bodies withstand physical attacks
 - Iron shroud protects shackle from cutting and prying



High Security – Solid Steel

- Heavy case hardened steel body
- Chrome rustproofing provides longer life
- Shrouded models protect against bolt cutters and prying



Weather Tough®

- Ideal for harsh outdoor conditions
 - Exclusive cover protects lock from water, ice, dirt and grime
 - Heavy duty steel bodies withstand physical attacks
 - Keyway cover keeps out dust and dirt
- Optional brass shackles available for increased corrosion resistance



Solid Brass

- Body provides extra resistance in caustic, corrosive and salty environments
- Optional brass shackle available for increased corrosion resistance



Pro Series® Interchangeable Cores & Padlocks — High Security — Iron Shroud

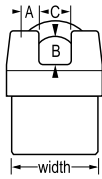

Example	6527 CA 7 26D KA LZ1 3KEY
	CY 7 26D KA
	6521 WO

Base Model	Description
6527	2-5/8in (67mm) wide body, A = 7/16in (11mm) dia., B = 3/4in (19mm), C = 7/8in (22mm)
6521	2-1/8in (54mm) wide body, A = 5/16in (8mm) dia., B = 3/4in (19mm), C = 7/8in (22mm)

Note: Control Keys Sold Separately! See page 55.

Function	Standard: Non-Key Retaining
NR	Non-Removable Key

Cores	REQUIRED CHOICE
WO	Lock without cylinder
WCS	Lock Body only
CY	Standard SFIC Keyway

Note: Core Only Packaging: Shelf Pack = 5, Master Carton = 20

No. of Pins	
6	6 Pins
7	7 Pins

Core Finish	
04	Satin Brass
26D	Satin Chrome

Keying	Standard: Keyed Different
UN	Uncombined (no keys)
KA	Keyed Alike
MK	Keyed Different; Master Keyed
KAMK	Keyed Alike; Master Keyed

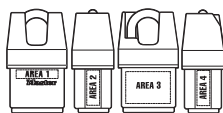

Custom Marking	
LZ1	Laser engraved in 1 area
LZ2	Laser engraved in 2 areas
LZ3	Laser engraved in 3 areas
LZ4	Laser engraved in 4 areas

Number of Keys	
1KEY	1 key per lock
3KEY	3 keys per lock
4KEY	4 keys per lock
NOKEY	0 keys per lock

Pro Series® Interchangeable Cores & Padlocks — Solid Steel

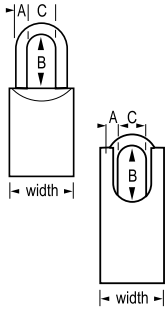

Example	7046 CY 6 26D
	CY 7 04 KAMK
	7051 LF WO

Base Model	Description
7051	2in (48mm) wide body, A = 3/8in (9mm) dia., B = 1-1/2in (38mm), C = 29/32in (23mm), Boron
7041	1-3/4in (44mm) wide body, A = 5/16in (8mm) dia., B = 1-3/16in (30mm), C = 29/32in (23mm)
7046	1-3/4in (44mm) wide Shrouded Steel body, A = 5/16in (8mm) dia., B = 1-3/16in (30mm), C = 29/32in (23mm)

Note: Control Keys Sold Separately! See page 55.

Shackle	Description
LF	Boron, B = 1-9/16in (40mm) (7041 option only)
LJ	Boron, B = 2-1/2in (64mm) (7041 & 7051 option only)

Chain	Description
CN	#40 Sash Chain, 9in (23cm) Long, Zinc Plated (7051, 7041 & 7031 Option only)

Function	Standard: Non-Key Retaining
NR	Non-Removable Key

Cores	REQUIRED CHOICE
WO	Lock without cylinder
WCS	Lock Body only
CY	Standard SFIC Keyway

Note: Core Only Packaging: Shelf Pack = 5, Master Carton = 20

No. of Pins	Description
6	6 Pins
7	7 Pins

Core Finish	Description
04	Satin Brass
26D	Satin Chrome

Keying	Standard: Keyed Different
UN	Uncombined (no keys)
KA	Keyed Alike
MK	Keyed Different; Master Keyed
KAMK	Keyed Alike; Master Keyed

Number of Keys	Description
1KEY	1 key per lock
3KEY	3 keys per lock
4KEY	4 keys per lock
NOKEY	0 keys per lock

Pro Series® Interchangeable Cores & Padlocks — Weather Tough®

Example	6427 LH CN CY 7 26D KA LZ2
	CY 6 04
	6421 LH WO

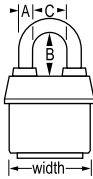

Base Model	Description
6427	2-5/8in (67mm) wide body, A = 7/16in (11mm) dia., B = 1-3/8in (35mm), C = 7/8in (22mm)
6421	2-1/8in (54mm) wide body, A = 5/16in (8mm) dia., B = 1-1/8in (29mm), C = 7/8in (22mm)

Note: Control Keys Sold Separately! See page 55.

Shackle	Standard: Boron, B = 1-1/8in (29mm)
LF	Boron, B = 1-1/2in (38mm) (6421 Option only)
LH	Boron, B = 1-7/8in (48mm) (6427 Option only)
LJ	Boron, B = 2-1/2in (64mm) (6427: B = 2-3/8in (60mm))



Chain	
CN	#40 Sash Chain, 9in (23cm) Long, Zinc Plated

Function	Standard: Non-Key Retaining
NR	Non-Removable Key

Cores	REQUIRED CHOICE
WO	Lock without cylinder
WCS	Lock Body only
CY	Standard SFIC Keyway

Note: Core Only Packaging: Shelf Pack = 5, Master Carton = 20

No. of Pins	
6	6 Pins
7	7 Pins

Core Finish	
04	Satin Brass
26D	Satin Chrome

Keying	Standard: Keyed Different
UN	Uncombined (no keys)
KA	Keyed Alike
MK	Keyed Different; Master Keyed
KAMK	Keyed Alike; Master Keyed



Custom Marking	
LZ1	Laser engraved in 1 area
LZ2	Laser engraved in 2 areas
LZ3	Laser engraved in 3 areas
LZ4	Laser engraved in 4 areas

Number of Keys	
1KEY	1 key per lock
3KEY	3 keys per lock
4KEY	4 keys per lock
NOKEY	0 keys per lock

All marks are registered trademarks of their respective owners.

KEY BLANKS: See pages 54-55 for respective key blanks or cut key information.

PP Unless otherwise specified, Shelf Pack = 6, Master Carton = 24 PP

Pro Series® Interchangeable Cores & Padlocks — Solid Brass

Example	6851 LF CN NR CY 7 04 KA
	CY 6 26D
	6841 LJ WO

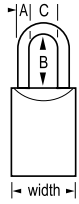

Base Model	Description
6851	2in (51mm) wide body, A = 3/8in (9mm) dia., B = 1-1/2in (37mm), C = 29/32in (23mm)
6841	1-3/4in (44mm) wide body, A = 5/16in (8mm) dia., B = 1-3/16in (30mm), C = 25/32in (23mm)

Note: Control Keys Sold Separately! See page 55.

Shackle	
LF	Boron, B = 1-9/16in (40mm) (6841 & 6831 option only)
LJ	Boron, B = 2-1/2in (64mm) (6851 option only), B = 2-7/16in (61mm) (6841 option only)

Chain	
CN	#40 Sash Chain, 9in (23cm) Long, Zinc Plated

Function	Standard: Non-Key Retaining
NR	Non-Removable Key

Cores	REQUIRED CHOICE
WO	Lock without cylinder
WCS	Lock Body only
CY	Standard SFIC Keyway

Note: Core Only Packaging: Shelf Pack = 5, Master Carton = 20

No. of Pins	
6	6 Pins
7	7 Pins

Core Finish	
04	Satin Brass
26D	Satin Chrome

Keying	Standard: Keyed Different
UN	Uncombined (no keys)
KA	Keyed Alike
MK	Keyed Different; Master Keyed
KAMK	Keyed Alike; Master Keyed

Custom Marking	
LZ1	Laser engraved in 1 area
LZ2	Laser engraved in 2 areas
LZ3	Laser engraved in 3 areas
LZ4	Laser engraved in 4 areas

Number of Keys	
1KEY	1 key per lock
3KEY	3 keys per lock
4KEY	4 keys per lock
NOKEY	0 keys per lock



All marks are registered trademarks of their respective owners.

Pro Series® Resettable Combination Locks

Example 1174 LZ2

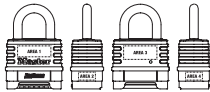

Base Model	Description
1174	2-1/4in (57mm) wide stainless steel body, A = 5/16in (8mm), B = 1-1/16in (27mm), C = 1in (25mm) round stainless steel shackle, Shelf Pack = 4, Master Carton = 24
1175	2-1/4in (57mm) wide brass body, A = 3/8in (10mm), B = 1-1/16in (27mm), C = 15/16in (24mm) octagonal boron-carbide shackle, Shelf Pack = 4, Master Carton = 24
1175LH	2-1/4in (57mm) wide brass body, A = 3/8in (10mm), B= 2-1/16in (53mm), C = 15/16in (24mm) octagonal boron-carbide shackle, Shelf Pack = 4, Master Carton = 24
1175LHSS	2-1/4in (57mm) wide brass body, A = 5/16in (8mm), B= 2-1/16in (53mm), C = 1in (25mm) round stainless steel shackle, Shelf Pack = 4, Master Carton = 24
1175RS	2-1/4in (57mm) wide brass body, A=5/16in (8mm), B=2-1/16in (53mm), C=1in (25mm) round boron-carbide shackle, Shelf Pack=4, Master Carton=24
1175LHRS	2-1/4in (57mm) wide brass body, A=5/16in (8mm), B=2-1/16in (53mm), C-1in (25mm) round boron-carbide shackle, Shelf Pack=4, Master Carton=24
1177	2-1/4in (57mm) wide shrouded brass body, A = 3/8in (10mm), B = 1-1/16in (27mm), C = 15/16in (24mm) octagonal boron-carbide shackle, Shelf Pack = 4, Master Carton = 24
1178	2-1/4in (57mm) wide die cast body, A = 3/8in (10mm), B = 1-1/16in (27mm), C = 15/16in (24mm) octagonal boron-carbide shackle, Shelf Pack = 4, Master Carton = 24
Custom Marking	
LZ1	Laser engraved in 1 area
LZ2	Laser engraved in 2 areas
LZ3	Laser engraved in 3 areas
LZ4	Laser engraved in 4 areas

Rekeyable Padlocks

- Quickly remove the current cylinder and either change the pins or replace the cylinder
- 5-pin tumbler cylinders provide more than 9,000 key changes for added pick resistance
- Rekeying kit (No. 291) contains an extensive assortment of the most frequently used components to replace or rekey cylinders

Die Cast Zinc Padlocks

- Chrome-plated lock body resists corrosion
- Hardened boron alloy shackle for superior cut resistance



Rekeyable Laminated Steel Padlocks

- Double locking mechanisms provide extra pry resistance
- Hardened boron alloy shackles — No. 25 and 101
- Hardened steel shackles — No. 21
- Hardened steel bottom plates for extra drill resistance — No. 25 and 21
- Top & bottom bumpers for greater scratch resistance



Rekeyable Padlocks — Die Cast Zinc

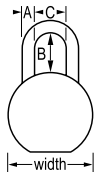

Example	230 WO
----------------	--------

Base Model	Description
230	2-1/2in (64mm) wide body, A = 7/16in (11mm) dia., C = 15/16in (24mm), Shelf Pack = 5, Master Carton = 20
220	2in (51mm) wide body, A = 7/16in (11mm) dia., C = 3/4in (19mm), Shelf Pack = 5, Master Carton = 30

BumpStop® Cylinder Technology

N	Anti-Bump Cylinder Technology (Not available with WO & WCS Option or UN & KZ Option)
----------	--

Keying **Standard:** Keyed Different

UN	Uncombined (Zero bitted cylinder & no keys) - Available with WP4 option only
KZ	Zero-Bitted (Not Available with WP option)
KA	Keyed Alike
MK	Keyed Different; Master Keyed
KAMK	Keyed Alike; Master Keyed

Shackle **Standard:** Boron, B = 1in (25mm)

LH	Boron, B = 2in (51mm)
-----------	-----------------------

Chain

CN	#40 Sash Chain, 9in (23cm) Long, Zinc Plated
-----------	--

Function **Standard:** Non-Key Retaining

NR	Non-Removable Key
-----------	-------------------

Cylinder **Standard:** 5-pin W27 cylinder

WO	Lock without cylinder
WCS	Lock Body only
W1	4-pin W1 cylinder
W15	5-pin W15 cylinder
W17	5-pin W17 cylinder
W27	5-pin W27 cylinder
W81	5-pin W81 cylinder
W600A	5-pin American Lock® W600A cylinder (Available as KA & KZ only)
WP4	Edge® Key Control 4-pin cylinder. Standard: Nickel Silver Keys

Number of Keys **Standard:** 2 keys per lock

1KEY	1 key per lock
3KEY	3 keys per lock
4KEY	4 keys per lock
NOKEY	0 keys per lock

Rekeyable Padlocks — Laminated Steel Pin Tumbler

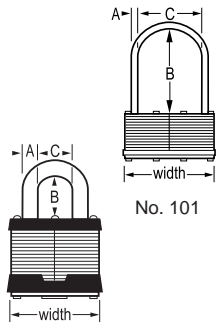

No. 101

Nos. 21,
& 25



Example	25 KA LF
Base Model	Description
101	3-1/4in (83mm) wide Laminated Steel body with Boron Shackle, A = 5/16in (8mm), B = 3in (76mm), C = 2-1/4in (57mm) Shelf Pack = 5, Master Carton = 20
25	2in (51mm) wide Laminated Steel body with Boron Shackle, A = 3/8in (10mm), B = 1in (25mm), C = 15/16in (24mm)
21	1-3/4in (44mm) wide Laminated Steel body with Hardened Steel Shackle, A = 5/16in (8mm), B = 15/16in (24mm), C = 3/4in (19mm)

BumpStop® Cylinder Technology	
N	Anti-Bump Cylinder Technology (Not available with WO & WCS Option or UN & KZ Option)

Keying	Standard: Keyed Different
UN	Uncombined (Zero bitted cylinder & no keys) - Available with WP6 & WP4 options only
KZ	Zero-Bitted (Not Available with WP option)
KA	Keyed Alike
MK	Keyed Different; Master Keyed
KAMK	Keyed Alike; Master Keyed

Shackle	
LF	B = 1-1/2in (38mm) (21 & 25 Option Only)
LJ	B = 2-1/2in (64mm) (21 & 25 Option Only)
LN	Hardened Steel, B = 5-3/4in (150mm) (21 Option Only)

Chain	
CN	#40 Sash Chain, 9in (23cm) Long, Zinc Plated

Cylinder	Standard: 5-pin W27 cylinder
WO	Lock without cylinder
W1	4-pin W1 cylinder
W2K	4-pin W2 cylinder (Available as MK & KAMK only)
W15	5-pin W15 cylinder
W17	5-pin W17 cylinder
W27	5-pin W27 cylinder
W81	5-pin W81 cylinder
W600A	5-pin American Lock® W600A cylinder (Available as KA & KZ only)
WP4	Edge® Key Control 4-pin cylinder. Standard: Nickel Silver Keys

Number of Keys	Standard: 2 keys per lock
1KEY	1 key per lock
3KEY	3 keys per lock
4KEY	4 keys per lock
NOKEY	0 keys per lock

Non-Rekeyable Padlocks

Commercial Magnum® Padlocks

- Stainless steel body cover for exceptional weatherability
- Chrome-plated shackle for excellent rust resistance
- Octagonal boron-carbide shackle is 50% harder than hardened steel
- Superior pry resistance with dual-ball bearing locking
- 4-pin tumbler cylinders provide pick resistance
- Key to match existing 4-pin W1 systems
- Edge® Key Control available



Covered Laminated Padlocks for Outdoor Protection

- High-tech thermoplastic shell designed to withstand the elements
- Hardened steel shackle with molded cover
- Dual locking mechanism provides extra pry resistance
- 1-9/16in (40mm) wide laminated steel body for superior strength
- 4-pin tumbler cylinder helps prevent picking



High Security Laminated Steel Padlocks

- Hardened boron alloy shackle for superior cut resistance
- Dual locking mechanism provides extra pry resistance
- Hardened steel bottom plates for extra drill resistance
- Top and bottom bumpers for greater scratch resistance
- Proprietary rustproofing for longer life
- 5-pin tumbler cylinders provide more than 9,000 key changes for added pick resistance – No. 15 & 17
- 4-pin tumbler cylinders provide pick resistance – No. 5



Shrouded Shackle Padlocks

- Armored shackle guard and hardened steel shackle defies cutting
- 1-9/16in (40mm) wide laminated steel body for superior strength
- 4-pin tumbler cylinder helps prevent picking



Laminated Steel Padlocks

- Hardened Steel shackles for extra cut resistance
- 5-pin tumbler cylinders provide more than 9,000 key changes for added pick resistance – No. 81 & 31
- 4-pin tumbler cylinders provide pick resistance – No. 1 & 3



Vending and Meter Padlocks

- Prevents access to vending and utility valve equipment
- Removable hardened steel shackle for extra cut resistance
- Hardened steel bottom plate for extra drill resistance
- Dual locking mechanism provides extra pry resistance
- 1-9/16in (40mm) wide laminated steel body for superior strength
- 4-pin tumbler cylinder helps prevent picking
- Top and bottom bumpers for greater scratch resistance



Laminated Brass Padlocks

- Brass bodies and cylinders provide excellent corrosion resistance – No. 82, 6, 2, 4
- Hardened steel shackles for extra cut resistance
- Optional brass shackles available for increased corrosion resistance



General Security Laminated Steel and Brass Padlocks

- 1-1/8in (29mm) wide body
- Standard steel shackle
 - Optional brass shackles available for increased corrosion resistance – No. 8
- 4-pin cylinder helps prevent picking
- Proprietary rustproofing for longer life – No. 7
- Brass bodies and cylinders provide excellent corrosion resistance – No. 8



Non-Rekeyable Padlocks — Commercial Magnum®

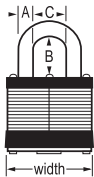

Example	M5 KA LF STS
Base Model	Description
M5 STS	2in (51mm) wide Commercial Magnum® Stainless Cover with Octagonal Boron-Carbide Shackle. A = 3/8in (10mm), C = 15/16in (24mm)
M1 STS	1-3/4in (44mm) wide Commercial Magnum® Stainless Cover with Octagonal Boron-Carbide Shackle. A = 5/16in (8mm), C = 13/16in (21mm)



BumpStop® Cylinder Technology	
N	Anti-Bump Cylinder Technology

Keying	Standard: Keyed Different
KA	Keyed Alike
KARAN	Keyed-Alike within Shelf Pack
MK	Keyed Different; Master Keyed
KAMK	Keyed Alike; Master Keyed

Shackle	Standard: Boron, B = 1in (25mm)
LF	Octagonal Boron Shackle, Boron, B = 1-1/2in (38mm)
LJ	Octagonal Boron Shackle, Boron, B = 2-1/2in (64mm)



Chain	
CN	#40 Sash Chain, 9in (23cm) Long, Zinc Plated

Cylinder	Standard: 4-pin W1 cylinder
W2K	4-pin W2 Cylinder (Available with MK or KAMK option only)
WP4	Edge® Key Control 4-pin cylinder. Standard: Nickel Silver Keys



Custom Marking	
LZ1	Laser engraved in 1 area
LZ2	Laser engraved in 2 areas
LZ3	Laser engraved in 3 areas
LZ4	Laser engraved in 4 areas

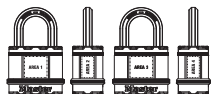

Number of Keys	Standard: 2 keys per lock
1KEY	1 key per lock
3KEY	3 keys per lock
4KEY	4 keys per lock
NOKEY	0 keys per lock

Non-Rekeyable Padlocks — 2in (51mm) Laminated Steel & Brass Pin Tumbler

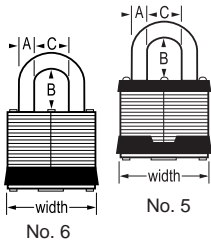

Example	5 KAMK
----------------	--------

Base Model	Description
5	2in (51mm) Wide, Laminated Steel body with Hardened Boron Shackle; A = 3/8in (10mm), B = 1in (25mm), C = 15/16in (24mm)
6	2in (51mm) Wide, Laminated Brass body with Hardened Boron Chrome Shackle, A = 3/8in (10mm), B = 1in (25mm), C = 15/16in (24mm)

BumpStop® Cylinder Technology	
N	Anti-Bump Cylinder Technology

Keying	Standard: Keyed Different
KA	Keyed Alike
KARAN	Keyed-Alike within Shelf Pack
MK	Keyed Different; Master Keyed
KAMK	Keyed Alike; Master Keyed

Shackle	Standard: Boron, B = 1-1/4in (32mm)
LF	Boron, B = 1-1/2in (38mm) (5 Option Only)
LJ	Boron, B = 2-1/2in (64mm) (5 Option Only)

Chain	
CN	#40 Sash Chain, 9in (23cm) Long, Zinc Plated

Cylinder	Standard: 5 & 6: 4-pin W1 cylinder
W2K	4-pin W2 Cylinder (Available with MK or KAMK option only)
WP4	Edge® Key Control 4-pin cylinder. Standard: Nickel Silver Keys

Number of Keys	Standard: 2 keys per lock
1KEY	1 key per lock
3KEY	3 keys per lock
4KEY	4 keys per lock
NOKEY	0 keys per lock

Non-Rekeyable Padlocks — 1-3/4in (44mm) Laminated Steel & Brass Pin Tumbler

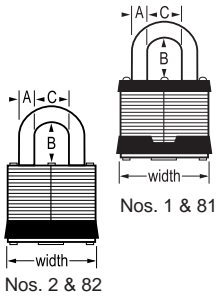

Example		1 KA LJ CN NOKEY
Base Model	Description	
1	1-3/4in (44mm) Wide, Laminated Steel body with Hardened Steel Shackle; A = 5/16in (8mm), B = 15/16in (24mm), C = 3/4in (19mm)	
81	1-3/4in (44mm) Wide, Laminated Steel body with Hardened Steel Shackle; A = 5/16in (8mm), B = 15/16in (24mm), C = 3/4in (19mm)	
2	1-3/4in (44mm) Wide, Laminated Brass body with Hardened Steel Shackle; A = 5/16in (8mm), B = 15/16in (24mm), C = 3/4in (19mm)	
82	1-3/4in (44mm) Wide, Laminated Brass body with Hardened Steel Chrome Shackle; A = 5/16in (8mm), B = 15/16in (24mm), C = 3/4in (19mm)	



BumpStop® Cylinder Technology	
N	Anti-Bump Cylinder Technology (1 & 2 Option Only)

Keying	Standard: Keyed Different
KA	Keyed Alike
KARAN	Keyed-Alike within Shelf Pack
MK	Keyed Different; Master Keyed
KAMK	Keyed Alike; Master Keyed

Shackle	
LF	Hardened Steel, B = 1-1/2in (38mm)
LJ	Hardened Steel, B = 2-1/2in (64mm)
LN	Hardened Steel, B = 5-3/4in (150mm)
B	Brass, B = 15/16in (24mm) (2 & 82 Option Only)
BLF	Brass, B = 1-1/2in (38mm) (2 & 82 Option Only)



Chain	
CN	#40 Sash Chain, 9in (23cm) Long, Zinc Plated

Cylinder	Standard: 1 & 2 Only: 4-pin W1 cylinder; 81 & 82 Only: 5-pin W81 Cylinder
W2K	4-pin W2 cylinder (Available with MK or KAMK option only)
W15	5-pin W15 cylinder (81 & 82 Option Only)
W17	5-pin W17 cylinder (81 & 82 Option Only)
W27	5-pin W27 cylinder (81 & 82 Option Only)
W600A	5-pin American Lock® W600A cylinder (81 and 82 Option Only) (Available as KA & KZ only)
WP4	Edge® Key Control 4-pin cylinder. Standard: Nickel Silver Keys

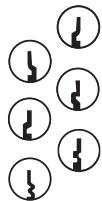

Number of Keys	Standard: 2 keys per lock
1KEY	1 key per lock
3KEY	3 keys per lock
4KEY	4 keys per lock
NOKEY	0 keys per lock

Non-Rekeyable Padlocks — 1-9/16in (40mm) Laminated Steel & Brass Pin Tumbler

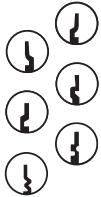
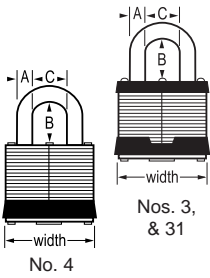

Example		3 KA LF
Base Model	Description	
3	1-9/16in (40mm) Wide, Laminated Steel body with Hardened Steel Shackle; A = 9/32in (7mm), B = 3/4in (19mm), C = 5/8in (16mm)	
31	1-9/16in (40mm) Wide, Laminated Steel body with Hardened Steel Shackle; A = 9/32in (7mm), B = 3/4in (19mm), C = 5/8in (16mm)	
4	1-9/16in (40mm) Wide, Laminated Brass body with Hardened Steel Chrome Shackle; A = 9/32in (7mm), B = 3/4in (19mm), C = 5/8in (16mm)	

BumpStop® Cylinder Technology	
N	Anti-Bump Cylinder Technology
Keying	
	Standard: Keyed Different
KA	Keyed Alike
KARAN	Keyed-Alike within Shelf Pack
MK	Keyed Different; Master Keyed
KAMK	Keyed Alike; Master Keyed
Shackle	
LF	Hardened Steel, B = 1-1/2in (38mm) (3 Option Only)
LH	Hardened Steel, B = 2in (51mm)
B	Brass, B = 3/4in (19mm) (4 Option Only)
Chain	
CN	#40 Sash Chain, 9in (23cm) Long, Zinc Plated
Cylinder	
	Standard: 3 & 4 Only 4-pin W1 cylinder; 31 Only 5-pin W-27 cylinder
W2K	4-pin W2 Cylinder (Available with MK or KAMK option only)
W15	5-pin W15 cylinder (31 Option Only)
W17	5-pin W17 cylinder (31 Option Only)
W81	5-pin W81 cylinder (31 Option Only)
W600A	5-pin American Lock® W600A cylinder (31 Option Only) (Available as KA & KZ only)
WP4	Edge™ Key Control 4-pin cylinder. Standard: Nickel Silver Keys
Number of Keys	
	Standard: 2 keys per lock
1KEY	1 key per lock
3KEY	3 keys per lock
4KEY	4 keys per lock
NOKEY	0 keys per lock

Non-Rekeyable Padlocks — 1-9/16in (40mm) Covered Laminated Steel Pin Tumbler



Example	312 MK LH
Base Model	Description
311	Black Cover, 1-9/16in (40mm) Wide, Laminated Steel body, with Hardened Steel Shackle; A = 3/8in (10mm), C = 1/2in (13mm)
312	Blue Cover, 1-9/16in (40mm) Wide, Laminated Steel body, with Hardened Steel Shackle; A = 3/8in (10mm), C = 1/2in (13mm)
315	Yellow Cover, 1-9/16in (40mm) Wide, Laminated Steel body, with Hardened Steel Shackle; A = 3/8in (10mm), C = 1/2in (13mm)



BumpStop® Cylinder Technology	
N	Anti-Bump Cylinder Technology

Keying	Standard: Keyed Different
KA	Keyed Alike
KARAN	Keyed-Alike within Shelf Pack
MK	Keyed Different; Master Keyed
KAMK	Keyed Alike; Master Keyed

Shackle	Standard: Hardened Steel with molded cover, B = 3/4in (19mm)
LF	Hardened Steel Shackle without cover, B = 1-1/2in (38mm)
LH	Hardened Steel with molded cover, B = 2in (51mm)

Cylinder	Standard: 4-pin W1 cylinder
W2K	4-pin W2 Cylinder (<i>Available with MK or KAMK option only</i>)
WP4	Edge® Key Control 4-pin cylinder. Standard: Nickel Silver Keys

Number of Keys	Standard: 2 keys per lock
1KEY	1 key per lock
3KEY	3 keys per lock
4KEY	4 keys per lock
NOKEY	0 keys per lock



Non-Rekeyable Padlocks — 1-9/16in (40mm) Shrouded Laminated Steel Pin Tumbler

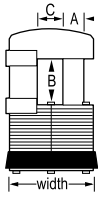

Example	37 KA
----------------	-------

Base Model	Description
37	1-9/16in (40mm) Wide, Laminated Steel body with Hardened Steel Shackle; A = 9/32in - 1/2in (7mm - 13mm), B = 15/16in (24mm), C = 7/16in (11mm)

BumpStop® Cylinder Technology	
N	Anti-Bump Cylinder Technology

Keying	Standard: Keyed Different
KA	Keyed Alike
KARAN	Keyed-Alike within Shelf Pack
MK	Keyed Different; Master Keyed
KAMK	Keyed Alike; Master Keyed

Cylinder	Standard: 4-pin W1 cylinder
W2K	4-pin W2 Cylinder (Available with MK or KAMK option only)
WP4	Edge® Key Control 4-pin cylinder. Standard: Nickel Silver Keys

Number of Keys	Standard: 2 keys per lock
1KEY	1 key per lock
3KEY	3 keys per lock
4KEY	4 keys per lock
NOKEY	0 keys per lock

Non-Rekeyable Padlocks — Special Application Vending & Meter Padlocks

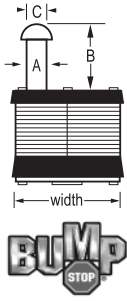

Example	443 MK LE
Base Model	Description
443LE	1-9/16in (40mm) Wide, Laminated Steel body with Hardened Steel Shackle; A = 3/8in (10mm), B = 7/8in (22mm), C = 5/8in (16mm)
BumpStop® Cylinder Technology	
N	Anti-Bump Cylinder Technology
Keying	Standard: Keyed Different
KA	Keyed Alike
MK	Keyed Different; Master Keyed
KAMK	Keyed Alike; Master Keyed
Cylinder	Standard: 4-pin W1 cylinder
W2K	4-pin W2 Cylinder (<i>Available with MK or KAMK option only</i>)
WP4	Edge® Key Control 4-pin cylinder. Standard: Nickel Silver Keys
Number of Keys	Standard: 2 keys per lock
1KEY	1 key per lock
3KEY	3 keys per lock
4KEY	4 keys per lock
NOKEY	0 keys per lock

Non-Rekeyable Padlocks — 1-1/8in Laminated Steel & Brass Pin Tumbler

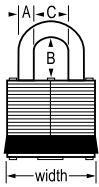

Example	8 B
----------------	-----

Base Model	Description
7	1-1/8in (29mm) wide, Laminated Steel body with Steel Shackle; A = 3/16in (5mm), C = 1/2in (13mm) - 4-pin W7 cylinder
8	1-1/8in (29mm) wide, Laminated Brass body with Chrome Steel Shackle; A = 3/16in (5mm), C = 1/2in (13mm) - 4-pin W7 cylinder

Keying	Standard: Keyed Different
KA	Keyed Alike
KARAN	Keyed-Alike within Shelf Pack
MK	Keyed Different; Master Keyed
KAMK	Keyed Alike; Master Keyed

Shackle	Standard: Steel, B = 9/16in (14mm)
LF	Steel, B = 1-1/2in (38mm)
LJ	Steel, B = 2-1/2in (64mm)
B	Brass, B = 9/16in (14mm) (8 Option Only)

Chain	
CN	#40 Sash Chain, 9in (23cm) Long, Zinc Plated

Number of Keys	Standard: 2 keys per lock
1KEY	1 key per lock
3KEY	3 keys per lock
4KEY	4 keys per lock
NOKEY	0 keys per lock



Universal Pin Padlocks and Accessories



- Universal Pin padlocks for keying convenience
- Locks pinned to customer's key in minutes. Operates with same key as Master Lock Padlocks (Nos. 1-6)
- Laminated steel bodies for superior strength
- Hardened steel (Nos. 1 and 3) and hardened boron alloy (No. 5) shackles
- 4-pin tumbler cylinders helps prevent picking
- Great choice for keyed alike applications
- No. 376 produces custom-pinned locks in minutes
- No. 376 on-site use with Universal Pin padlocks

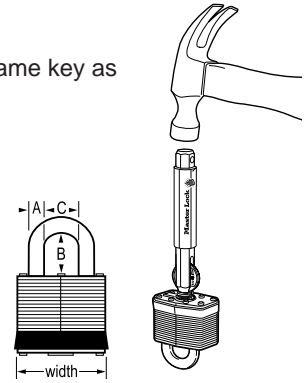

Universal Pin Series Padlocks and Tool

Commercial Boxed Products

Product Number	Description	Shelf Pack Quantity	Master Carton Quantity	Shackle Dimensions			Shackle Dimensions (Metric)		
				A	B	C	A	B	C
Universal Pin Padlocks									
1UP	Universal Pin; 1-3/4in (44mm) wide body	6	24	5/16in	15/16in	3/4in	8mm	24mm	19mm
1UPLJ	Universal Pin; 1-3/4in (44mm) wide body; 2-1/2in (64mm) Shackle	6	24	5/16in	2-1/2in	3/4in	8mm	64mm	19mm
3UP	Universal Pin; 1-9/16in (40mm) wide body	6	24	9/32in	3/4in	5/8in	7mm	19mm	16mm
3UPLF	Universal Pin; 1-9/16in (40mm) wide body; 1-1/2in (38mm) Shackle	6	24	9/32in	1-1/2in	5/8in	7mm	38mm	16mm
5UP	Universal Pin; 2in (51mm) wide body	6	24	3/8in	1in	15/16in	10mm	25mm	24mm
5UPLF	Universal Pin; 2in (51mm) wide body; 1-1/2in (38mm) Shackle	6	24	3/8in	1-1/2in	15/16in	10mm	38mm	24mm
Universal Pin Keying Tool									
376	Hand-held Keying Tool; Hammer required for operation	—	36	NA	NA	NA	NA	NA	NA

Shrouded Padlocks



- Fully shielded design minimizes shackle exposure and protects against bolt cutter attacks
- Key retaining feature ensures padlock is not left unlocked
- 2-3/4in (70mm) wide stainless steel body resists corrosion
- Hardened steel shackle for extra cut resistance
- 4-pin cylinder helps prevent picking
- Double deadbolt locking to guard against pulling

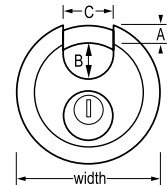

No. 40 Padlocks

Retail Carded Products

Product Number	Description	Shelf Pack Quantity	Master Carton Quantity	Shackle Dimensions			Shackle Dimensions (Metric)		
				A	B	C	A	B	C
40KADPF	Keyed Alike; Series Packaging	6	36	3/8in	5/8in	3/4in	10mm	16mm	19mm

NOTE: WHEN ORDERING KEYED ALIKE PADLOCKS, EACH DIFFERENT KEYED ALIKE SET IS A SEPARATE LINE ITEM.

KEY BLANKS: See pages 54-55 for respective key blanks or cut key information.

PP Unless otherwise specified, Shelf Pack = 6, Master Carton = 24 PP

Combination Padlocks



- Set-your-own 4-digit combination for convenience and security
- Reset to any of 10,000 personalized combinations
- Nos. 878 and 975 – no combination reset tool required
- 2in (51mm) wide solid brass case for strength and weatherability
- Hardened steel shackles for cut resistance
- No. 176 offers key override
- No. 178BLK and 878 offers economical die cast construction

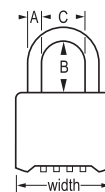

Nos. 175, 176, 178, 878 and 975 Padlocks

Also available - Pro Series® Resetable Combination Locks offer increased security, weatherability and added user conveniences, see page 26.

Commercial Boxed Products

Product Number	Description	Shelf Pack Quantity	Master Carton Quantity	Shackle Dimensions			Shackle Dimensions (Metric)		
				A	B	C	A	B	C
175	Set-Your-Own Combination	6	36	5/16in	1in	1in	8mm	25mm	25mm
175LH	Set-Your-Own Combination; 2-1/4in (57mm) Shackle	6	36	5/16in	2-1/4in	1in	8mm	57mm	25mm
175LHSS	Set-Your-Own Combination; 2-1/4in (57mm) Stainless Steel Shackle	6	36	5/16in	2-1/4in	1in	8mm	57mm	25mm
176	Set-Your-Own Combination; Key Over-Ride*	6	36	5/16in	1in	1in	8mm	25mm	25mm
176KA	Set-Your-Own Combination; Key Over-Ride*; Keyed Alike	6	36	5/16in	1in	1in	8mm	25mm	25mm
176LH	Set-Your-Own Combination; 2-1/4in (57mm) Shackle Key Over-Ride*	6	36	5/16in	2-1/4in	1in	8mm	57mm	25mm
176KALH	Set-Your-Own Combination; 2-1/4in (57mm) Shackle; Key Over-Ride*; Keyed Alike	6	36	5/16in	2-1/4in	1in	8mm	57mm	25mm
178BLK	Set-Your-Own Combination; Black	6	36	5/16in	1in	1in	8mm	25mm	25mm
878	Set-Your-Own Combination; Black Powder Coated Zinc Body; No Combination Reset Tool Required	6	36	5/16in	1in	1in	8mm	25mm	25mm
975	Set-Your-Own Combination; No Combination Reset Tool Required	6	36	5/16in	1in	1in	8mm	25mm	25mm
975LH	Set-Your-Own Combination; 2-1/4in (57mm) Shackle; No Combination Reset Tool Required	6	36	5/16in	2in	1in	8mm	51mm	25mm

*Order 176 cut keys – See page 54.

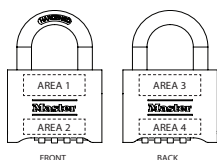

Custom Marking

LZ1	Laser engraved in 1 area
LZ2	Laser engraved in 2 areas
LZ3	Laser engraved in 3 areas
LZ4	Laser engraved in 4 areas

NOTE: WHEN ORDERING COMBINATION ALIKE PADLOCKS, EACH DIFFERENT COMBINATION ALIKE SET IS A SEPARATE LINE ITEM.

KEY BLANKS: See pages 54-55 for respective key blanks or cut key information.

PP Unless otherwise specified, Shelf Pack = 6, Master Carton = 24 PP

Combination Padlocks



- World's best selling combination lock
- BlockGuard® Anti-Shim Technology withstands attempts to violate the latch mechanism
- 1-7/8in (48mm) wide double-armored stainless steel body
- Hardened steel shackle for extra cut resistance
- Combination security for keyless convenience
- 3-digit dialing and 1,500 combinations for maximum security

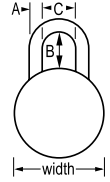

No. 1500 Padlocks

Commercial Boxed Products

Product Number	Description	Shelf Pack Quantity	Master Carton Quantity	Shackle Dimensions			Shackle Dimensions (Metric)		
				A	B	C	A	B	C
1500	Combination Different	12	72	9/32in	3/4in	13/16in	7mm	19mm	21mm
1500KA	Combination Alike	12	72	9/32in	3/4in	13/16in	7mm	19mm	21mm
1500LF	Combination Different; 1-1/2in (38mm) Shackle	6	36	9/32in	1-1/2in	13/16in	7mm	38mm	21mm
1500LH	Combination Different; 2in (51mm) Shackle	6	36	9/32in	2in	13/16in	7mm	51mm	21mm



- Set-your-own 3-digit combination
- Intuitive, easy to use design
- Retains current combination until re-set

Multi-User Built-in Mechanical Locks

Commercial Boxed Products

Product Number	Description	Master Carton Quantity
3630	Set-your-own combination lock - for standard lift handle lockers - manual deadbolt locking, right-hand hinged door - override key sold separately	25
3631	Set-your-own combination lock - for stadard lift handle lockers - manual deadbolt locking, left-hand hinged door - override key sold separately	25
3670	Set-your-own combination lock - for lift handle, turn handle and single point latch/box horizontal latch lockers - manual deadbolt locking, right-hand or left-hand hinged door - override key sold separately	25

Options & Accessories

K3630	Supervisory override key	NA
3630-0320	Extension kit for doors with a thickness of 11/16in (17mm) to 3/4in (19mm)	NA
3633LES	English/Spanish user instruction magnets	NA
3633LEF	English/French user instruction magnets	NA
3634LES	English/Spanish user instruction stickers	NA
3634LEF	English/French user instruction stickers	NA

Electronic Security



Combine the cost benefits and convenience of keyless security with the control, flexibility and accountability of Bluetooth enabled hardware and included Master Lock Vault Enterprise software. This integrated solution provides efficient and effective administration of security management and user access. The Master Lock Vault Enterprise suite of Bluetooth enabled products can be mixed and matched to fit your application needs.

- Durable, reliable padlocks that feature anti-shim technology for maximum security
- Strong, weather-resistant lock boxes have a large storage capacity for keys and key cards
- Door controller easily wires into electric strikes or magnetic locks and fits inside standard door frames.

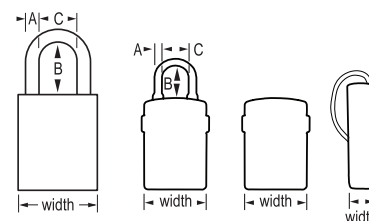
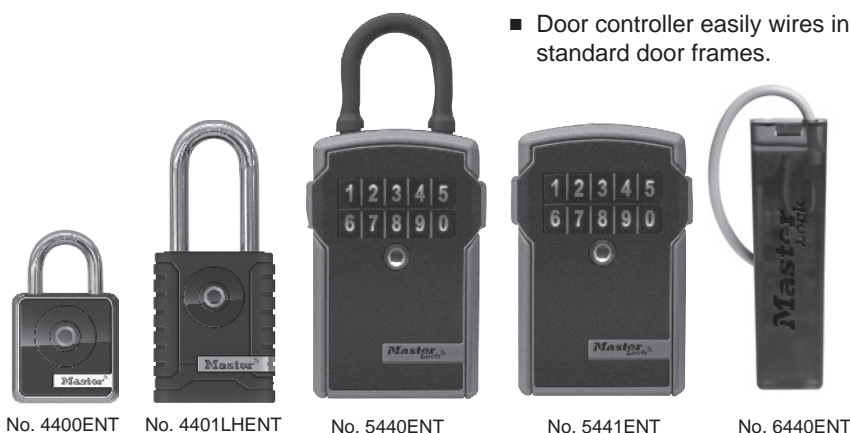

Bluetooth® Enabled Products

Commercial Boxed Products

Product Number	Description	Shelf Pack Quantity	Master Carton Quantity	Shackle Dimensions			Shackle Dimensions (Metric)		
				A	B	C	A	B	C
Bluetooth Padlocks									
4400ENT	Indoor Bluetooth Padlock, 1-29/32in (47mm) wide body	2	8	9/32in	7/8in	13/16in	7mm	22mm	20mm
4401LHENT	Outdoor Bluetooth Padlock, 2-7/32in (56mm) wide body, 2in (51mm) Shackle	2	8	11/32in	2in	15/16in	9mm	51mm	23mm
Bluetooth Lockboxes									
5440ENT	Bluetooth® Portable Lock Box, 3-1/4in (83mm) wide	1	2	13/32in	1-13/16in	1-13/32in	10mm	46mm	36mm
5441ENT	Bluetooth® Wall Mount Lock Box, 3-1/4in (83mm) wide	1	2	NA	NA	NA	NA	NA	NA
Bluetooth Door Controller									
6440ENT	Bluetooth® Door Controller, 1-13/32in (36mm) wide	4	24	NA	NA	NA	NA	NA	NA

Warded Padlocks



- Laminated steel body for superior strength
- Steel shackle provides strong cut resistance
- Warded locking mechanism minimizes jamming from dirt and grime
- Rustproofed for extended wear

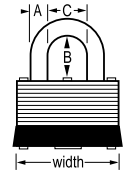

Nos. 10, 22, 105, 500, 510 and 517 Padlocks

Commercial Boxed Products

Product Number	Description	Shelf Pack Quantity	Master Carton Quantity	Shackle Dimensions			Shackle Dimensions (Metric)		
				A	B	C	A	B	C
1in (25mm) wide, Laminated Steel Body									
10D	Keyed Different; Retail Carded	4	24	5/32in	7/16in	13/32in	4mm	11mm	10mm
10KA	Keyed Alike	12	144	5/32in	7/16in	13/32in	4mm	11mm	10mm
1-1/8in (29mm) wide, Laminated Steel Body									
105D	Keyed Different; Retail Carded	4	24	3/16in	1/2in	1/2in	5mm	13mm	13mm
105KA	Keyed Alike	12	72	3/16in	1/2in	1/2in	5mm	13mm	13mm
1-1/2in (38mm) wide, Laminated Steel Body									
22D	Keyed Different; Retail Carded	4	24	1/4in	5/8in	9/16in	6mm	16mm	14mm
22T	2-Pack of No. 22 Keyed Alike; Retail Carded	4	16	1/4in	5/8in	9/16in	6mm	16mm	14mm
22	Keyed Different	12	72	1/4in	5/8in	9/16in	6mm	16mm	14mm
22KA	Keyed Alike	12	72	1/4in	5/8in	9/16in	6mm	16mm	14mm
3009D	4-Pack of No. 22 Keyed Alike; Retail Carded	4	16	1/4in	5/8in	9/16in	6mm	16mm	14mm
22KALF	Keyed Alike; 1-1/2in (38mm) Shackle	6	36	1/4in	1-1/2in	9/16in	6mm	38mm	14mm
1-3/4in (44mm) wide, Laminated Steel Body									
500D	Keyed Different; Retail Carded	4	24	9/32in	13/16in	13/16in	7mm	21mm	21mm
500	Keyed Different	12	72	9/32in	13/16in	13/16in	7mm	21mm	21mm
500KA	Keyed Alike	12	72	9/32in	13/16in	13/16in	7mm	21mm	21mm
500KABRK	Keyed Alike; Breakaway Shackle	12	72	9/32in	13/16in	13/16in	7mm	21mm	21mm
1-3/4in (44mm) wide, Laminated Steel Lock with Standard Steel Adjustable Shackle									
510D	Keyed Different; Retail Carded	4	24	9/32in	5/8-2in	13/16in	7mm	16-51mm	21mm
510KAD	Keyed Alike; Retail Carded	4	24	9/32in	5/8-2in	13/16in	7mm	16-51mm	21mm
517D	Keyed Different; Retail Carded	4	24	9/32in	2-3/4in-5-3/8in	13/16in	7mm	7-14cm	21mm
517KAD	Keyed Alike; Retail Carded	4	24	9/32in	2-3/4in-5-3/8in	13/16in	7mm	7-14cm	21mm

KEY BLANKS: See pages 54-55 for respective key blanks or cut key information.

☐☐ Unless otherwise specified, Shelf Pack = 6, Master Carton = 24 ☐☐

Economy Brass Series Padlocks



- Case hardened shackle resists sawing and filing
- Brass body and cylinder provide extra resistance to the elements
- Pin tumbler cylinder provides greater pick resistance

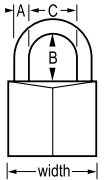

Nos. 4120, 4130, 4140 and 4150 Padlocks

Commercial Boxed Products

Product Number	Description	Shelf Pack Quantity	Master Carton Quantity	Shackle Dimensions			Shackle Dimensions (Metric)		
				A	B	C	A	B	C
4120	3/4in (19mm) Keyed Different; 3-pin Tumbler	12	72	5/32in	7/16in	3/8in	4mm	11mm	9mm
4120KA	Keyed Alike	12	72	5/32in	7/16in	3/8in	4mm	11mm	9mm
4130	1-1/8in (29mm) Keyed Different; 4-pin Tumbler	12	72	3/16in	9/16in	9/16in	5mm	14mm	15mm
4130KA	Keyed Alike	12	72	3/16in	9/16in	9/16in	5mm	14mm	15mm
4130KALF	Keyed Alike; 1-1/2in (38mm) Shackle	12	72	3/16in	1-1/2in	9/16in	5mm	38mm	15mm
4140	1-1/2in (38mm) Keyed Different; 4-pin Tumbler	12	72	1/4in	13/16in	13/16in	6mm	20mm	20mm
4140KA	Keyed Alike	12	72	1/4in	13/16in	13/16in	6mm	20mm	20mm
4140LH	Keyed Different; 2-1/4in (57mm) Shackle	12	72	1/4in	2-1/4in	13/16in	6mm	57mm	20mm
4140KALH	Keyed Alike; 2-1/4in (57mm) Shackle	12	72	1/4in	2-1/4in	13/16in	6mm	57mm	20mm
4150	1-7/8in (48mm) Keyed Different; 5-pin Tumbler	6	72	9/32in	15/16in	1in	7mm	24mm	25mm
4150KA	Keyed Alike	6	72	9/32in	15/16in	1in	7mm	24mm	25mm
4150LJ	Keyed Different; 2-1/2in (64mm) Shackle	6	72	9/32in	2-1/2in	1in	7mm	64mm	25mm
4150KALJ	Keyed Alike; 2-1/2in (64mm) Shackle	6	72	9/32in	2-1/2in	1in	7mm	64mm	25mm

Python® Adjustable Locking Cable

- Patented locking mechanism holds the cable tight for infinite locking positions
- Weather tough aluminum alloy body, cylinder shutter and vinyl coated cable resist rust and operate in extreme conditions
- Keyed-alike convenience with the removeable, rekeyable cylinder -- key to other Python locking cables or other Master Lock systems with the M1 keyway
- Increased pick resistance with patented disk tumbler cylinder
- Cut resistant, 3/8in (10mm) 100% steel braided cable
- 6ft (1.8m) to 30ft (9.1m) Interchangeable cables for application flexibility



8413

Example	8413 KA CBL 24
Base Model	Description
8413	Python® Adjustable Locking Cable, A = 3/8in (10mm) - Shelf Pack = NA, Master Carton = 6
Keying	Standard: Keyed Different
KZ	Zero-Bitted
KA	Keyed Alike
Cable Length	REQUIRED CHOICE
CBLN	Length of Cable (N =6 feet through 30 feet, increments of 1 foot) Ex. CBL6 - CBL30
Number of Keys	Standard: 2 keys per lock
1KEY	1 key per lock
3KEY	3 keys per lock
4KEY	4 keys per lock
NOKEY	0 keys per lock

Retail Carded Products

Product Number	Description	Shelf Pack Quantity	Master Carton Quantity	Cable Length	Outside Diameter of Cable	Cable Length (Metric)	Outside Diameter of Cable (Metric)
Yellow Locking Head With Black Bumper							
8413DPF	Keyed Different; 6ft (1.8m) x 3/8in (10mm) Adjustable Locking Cable	—	6	72in (6ft)	3/8in	1.8m	10mm
Silver Locking Head With Black Bumper							
8428DPS	Keyed Different; 6ft (1.8m) x 3/8in (10mm) Adjustable Locking Cable	—	6	72in (6')	3/8in	1.8m	10mm
General Use; Black Body & Bumper							
8418D	Keyed Different; 6ft (1.8m) x 5/16in (8mm) Adjustable Locking Cable	—	4	72in (6ft)	5/16in	1.8m	8mm
8418KADCAMO-TMB	Keyed Alike; 6ft (1.8m) x 5/16in (8mm) Adjustable Locking Cable; Camo Cover	—	4	72in (6ft)	5/16in	1.8m	8mm
8419DPF	Keyed Different; 6ft (1.8m) x 5/16in (8mm) Adjustable Locking Cable	—	4	72in (6ft)	5/16in	1.8m	8mm
8417D	Keyed Different; 6ft (1.8m) x 3/16in (5mm) Adjustable Locking Cable	—	4	72in (6ft)	3/16in	1.8m	5mm

KEY BLANKS: See pages 54-55 for respective key blanks or cut key information.

PP Unless otherwise specified, Shelf Pack = 6, Master Carton = 24 PP

High Security King Pin Locks

- Secures the king pin of semi-trailers, RVs and other fifth wheel trailers
 - Renders bolt cutters useless
- High grade aluminum is lightweight while providing high security
- High visibility red body and durable flag alert drivers that lock is attached
- Includes an integrated No 5 lock with all of its security and keying flexibility



Example 387 KA W27

Base Model	Description
387	High Security King Pin comes with #5 Padlock, 4-pin W1 cylinder - Shelf Pack = NA, Master Carton = 1

Note: Also available with Interchangeable Core (3871) and Key-In-Knob Cylinder (3872)



BumpStop® Cylinder Technology

N	Anti-Bump Cylinder Technology (Not available with WO & WCS Option or UN & KZ Option)
---	--

Keying Standard: Keyed Different

UN	Uncombined (Zero bitted cylinder & no keys) - Available with WP6 & WP4 options only (388 & 3870 option only)
KZ	Zero-Bitted (Not available with WP option or 387 model)
KA	Keyed Alike
MK	Keyed Different; Master Keyed
KAMK	Keyed Alike; Master Keyed

Function Standard: Non-Key Retaining

NR	Non-Removable Key (3870 Option Only)
----	--------------------------------------

Cylinder Standard: See Base Model Description

WO	King Pin Lock without cylinder (388 & 3870 Option Only)
WL	King Pin Only (387 Option Only)
W1	4-pin W1 cylinder (388 & 3870 Option Only)
W2K	4-pin W2 cylinder (387 & 388 Option Only)
W15	5-pin W15 cylinder (388 & 3870 Option Only)
W17	5-pin W17 cylinder (388 & 3870 Option Only)
W27	5-pin W27 cylinder (388 & 3870 Option Only)
W81	5-pin W81 cylinder (388 & 3870 Option Only)
W7000	6-pin W7000 cylinder (3870 Option Only)
W7000NISI	6-pin W7000 cylinder (3870 Option Only) with Nickel Silver Key
W600A	5-pin American Lock® W600A cylinder (388 & 3870 Option Only)
W700A	6-pin American Lock® W700A cylinder (3870 Option Only)
WP4	Edge® Key Control 4-pin cylinder. Standard: Nickel Silver Keys
WP6	Edge® Key Control 6-pin cylinder. Standard: Nickel Silver Keys (3870 Option Only)

Number of Keys Standard: 2 keys per lock

1KEY	1 key per lock
3KEY	3 keys per lock
4KEY	4 keys per lock
NOKEY	0 keys per lock



SAFESPACE® Storage Security



No. 7126D

- Heavy duty steel construction with full length, hinged door and built-in, slotted key racks
- Durable, beige powder coated cabinet finish
- Rekeyable wafer cylinder lock that utilizes our K1 Key with improved pick resistance
- Key retaining security insures key cannot be removed until cabinet is locked
- 2 keys, key holders, cross reference chart and installation hardware included

Key Cabinets

Retail Carded Products

Product Number	Description	Master Carton Quantity
7125D	Heavy Duty Key Cabinet holds 60 keys. 12-1/4in (31.1cm) x 10-3/4in (27.3cm) x 3in (7.6cm)	4
7126D	Heavy Duty Key Cabinet holds 120 keys. 17in (43.2cm) x 13in (33cm) x 3-1/4in (8.3cm)	4



No. 7116D



No. 7117D

- Fits most key cabinets and key racks
- No. 7117 snap hook design fits slotted and key style key cabinets, boards, etc. For use with 7125D and 7126D

Plastic Key Tags and Hangers

Retail Carded Products

Product Number	Description	Master Carton Quantity
7116D	Plastic Key Tags; 20 tags per bag. 1-1/4in (32mm) x 1-1/10in (28mm) x 1/2in (12mm)	10 bags
7117D	Plastic Key Holder; 20 holders per bag. 1-1/2in (38mm) x 1-2/3in (42mm) x 4/5in (20mm)	10 bags



No. 7120D

- Safely carry cash, jewelry and confidential documents
- Water resistant nylon
- Built in high security lock
- Identification holder and card

SAFESPACE® Storage Bag

Retail Carded Products

Product Number	Description	Master Carton Quantity
7120D	Locking storage bag. 10in (25.4cm) H x 8-5/8in (21.9cm) W x 1-7/8in (4.8cm) D	6

SAFESPACE® Storage Security



No. 5424D

No. 5425D

- Large, easy to read light-up dials
- Dials light up automatically when cover is opened
- Large open lever for more comfortable use
- Durable weather cover prevents freezing and jamming
- Vinyl coated shackle and molded bumper prevents scratches to your door
- Set your own combination for easy to use convenience – 10,000 possible combinations

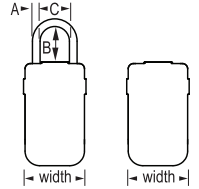

SAFESPACE® Light-Up Dial Lock Boxes

Retail Carded Products

Product Number	Description	Shelf Pack Quantity	Master Carton Quantity	Shackle Dimensions			Shackle Dimensions (Metric)		
				A	B	C	A	B	C
5424D	Portable Light-Up Dial Lock Box	—	4	3/8in	1-11/16in	1-13/32in	9mm	43mm	36mm
5425D	Wall Mount Light-Up Dial Lock Box	—	4	NA	NA	NA	NA	NA	NA



No. 5420D

- Adjustable shackle fits securely on most door hardware styles
- Large open lever for more comfortable use
- Durable weather cover prevents freezing and jamming
- Vinyl coated shackle and molded bumper prevents scratches to your door
- Set your own combination for easy to use convenience – 10,000 possible combinations

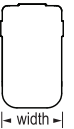

SAFESPACE® Universal Lock Box

Retail Carded Products

Product Number	Description	Shelf Pack Quantity	Master Carton Quantity	Shackle Dimensions			Shackle Dimensions (Metric)		
				A	B	C	A	B	C
5420D	2-7/8in (72mm) wide, Portable Universal Lock Box	—	4	3/8in	3/4in – 3/4in	1-13/32in	9mm	19mm – 44mm	36mm



No. 5422D

No. 5423D

- Provides secure storage of keys or access cards
- Convenient push button locking mechanism in familiar alpha / numeric telephone keypad format
- Set your own combination using up to 12 letters, numbers, or both
- Large buttons for ease of use, even in low light conditions
- Large internal cavity and removable key hook prevents jamming
- Protective weather cover prevents freezing and jamming

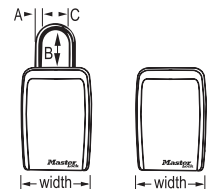

SAFESPACE® Push Button Lock Boxes

Retail Carded Products

Product Number	Description	Shelf Pack Quantity	Master Carton Quantity	Shackle Dimensions			Shackle Dimensions (Metric)		
				A	B	C	A	B	C
5422D	3-1/8in (79mm) Wide Set Your Own Combination Push Button Portable Lock Box	—	4	13/32in	1-5/6in	1-13/32in	10mm	46mm	36mm
5423D	3-1/8in (79mm) Wide Set Your Own Combination Push Button Wall Mount Lock Box	—	4	NA	NA	NA	NA	NA	NA

KEY BLANKS: See pages 54-55 for respective key blanks or cut key information.

PP Unless otherwise specified, Shelf Pack = 6, Master Carton = 24 PP

SAFESPACE® Storage Security



No. 5400D



No. 5406D

- Storage compartment holds multiple house, car or padlock keys
- No lockouts or schedule conflicts
- Locking combination convenience
- Durable metal construction

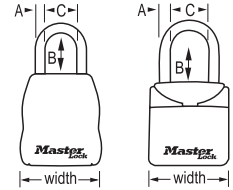

SAFESPACE® Combination Dial Portable Lock Boxes

Retail Carded Products

Product Number	Description	Shelf Pack Quantity	Master Carton Quantity	Shackle Dimensions			Shackle Dimensions (Metric)		
				A	B	C	A	B	C
5400D	Portable Lock Box; Set Your Own 4-digit Combination; Holds up to 5 keys; 3-1/4in (83mm) wide	—	4	13/32in	1-7/8in	1-13/32in	10mm	47mm	36mm
5406D	Compact Portable Lock Box; Set Your Own 3-digit Combination; Holds 2-3 keys; 2-3/4in (70mm) wide	2	4	13/32in	1-7/8in	1-13/32in	10mm	47mm	36mm



No. 5401D

- Storage compartment holds multiple house, car or padlock keys
- No lockouts or schedule conflicts
- Locking combination convenience
- Durable metal construction



SAFESPACE® Combination Dial Wall Mount Lock Boxes

Retail Carded Products

Product Number	Description	Shelf Pack Quantity	Master Carton Quantity	Shackle Dimensions			Shackle Dimensions (Metric)		
				A	B	C	A	B	C
5401D	Wall Mount Lock Box; Set Your Own Combination Holds up to 5 keys; 3-1/4in (83mm) wide	—	4	NA	NA	NA	NA	NA	NA



No. 207D

- Large internal capacity fits most keys, including keys with integrated FOB*
- Rust free, durable plastic construction
- Recessed magnet securely attaches and holds case to any steel surface
- Improved sliding cover design with built-in stop to prevent cover from being dropped or misplaced
- New discreet design to conceal your keys

*This product is not intended to be waterproof and is not recommended for outdoor use with electronic items

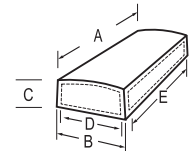

SAFESPACE® Magnetic Key Case

Retail Carded Products

Product Number	Description	Shelf Pack Quantity	Master Carton Quantity	Product Dimensions					Product Dimensions (Metric)				
				A	B	C	D	E	A	B	C	D	E
207D	Large Magnetic Key Case	4	24	4-11/16in	2in	1-3/16in	1-5/8in	3-7/8in	119mm	51mm	29mm	41mm	97mm

Hasps



No. 770LHC

- Ideal for vans, trucks, gates and vending
- Hardened solid steel hasp withstands forcible attacks
- Defeats attempts to pry and cut
- Designed for use with No. 6271 hidden shackle locks (page 10)

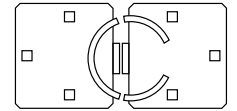

No. 770

High Security Hidden Shackle Padlock Hasp

Commercial Boxed Products

Product Number	Description	Shelf Pack Quantity	Master Carton Quantity	Hasp Length	Accepts Shackle Dia. Up To:	Hasp Length (Metric)	Accepts Shackle Dia. (Metric) Up To:
770	9in (23cm) wide x 4-1/2in (11cm) high	—	12	9in	—	23cm	—
770LHC	2-7/8in (73mm) Die Cast Padlock and Steel Hasp	—	6	9in	—	23cm	—

NOTE: For additional hasps, see Retail Price Book.



No. 731



No. 730



No. 732

- Zinc plated hardened steel for added strength and weatherability
- Hardened steel staple resists cutting, sawing and hammering
- Hasp body conceals mounting hardware
- Mounting hardware included for easy installation
- No. 730 is ideal for utility vans, trailers, gang boxes, vending machines
- Combine No. 730 with Nos. 6271 hidden shackle locks for maximum security

Heavy Duty Hasps

Commercial Boxed Products

Product Number	Description	Shelf Pack Quantity	Master Carton Quantity	Hasp Length	Accepts Shackle Dia. Up To:	Hasp Length (Metric)	Accepts Shackle Dia. (Metric) Up To:
730DPF	7-1/4in (18cm) Straight Bar	6	24	7-1/4in	7/16in	18cm	11mm
731	90° Angle Bracket	6	24	5-3/16in	7/16in	13cm	11mm
732	90° Angle Bar	6	24	4-3/4in	7/16in	12cm	11mm



No. 720DPF



No. 722DPF

- Secure hard-to-lock property
- Hardened steel body for added strength
- Hardened boron alloy staples resist cutting and sawing
- Single and double hinge styles with hidden hinge pins
- Ideal for corners and angles

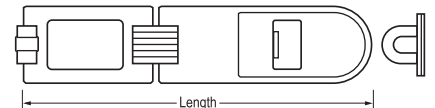

Hinged Hasps

Retail Carded Products

Product Number	Description	Shelf Pack Quantity	Master Carton Quantity	Hasp Length	Accepts Shackle Dia. Up To:	Hasp Length (Metric)	Accepts Shackle Dia. (Metric) Up To:
720DPF	6-1/4in (16cm) Single-hinge	4	24	6-1/4in	7/16in	16cm	11mm
722DPF	7-3/4in (20cm) Double-hinge	4	24	7-3/4in	7/16in	20cm	11mm

Padlock Eyes



No. 60R



No. 60

- Steel padlock eyes with large diameter shackle hole
- Mount virtually anywhere
- Ideal for gates and shed doors
- Add safety lockout capabilities to older equipment

Padlock Eyes

Commercial Boxed Products

Product Number	Description	Shelf Pack Quantity	Master Carton Quantity	Accepts Shackle Dia. Up To:	Accepts Shackle Dia. (Metric) Up To:
60	Flat Orientation, One pair	12	72	1/2in	13mm
60R	Right-angle Orientation, One pair	6	72	1/2in	13mm

Hasplocks

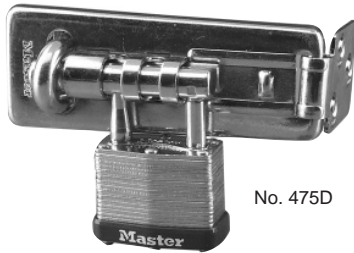

No. 475D

- Hasps with integral locking mechanisms for security and convenience
- Hardened steel hasps with laminated steel lock body
- 4-pin tumbler cylinder helps prevent picking
- Ribbed hasp plate for extra strength
- Hardened steel locking eye for strong cut resistance

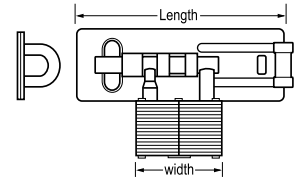

No. 450 Hasplock

Commercial Boxed Products

Product Number	Description	Shelf Pack Quantity	Master Carton Quantity	Hasp Length	Accepts Shackle Dia. Up To:	Hasp Length (Metric)	Accepts Shackle Dia. (Metric) Up To:
General-Use Hasplocks, Warded Mechanism							
450D	Keyed Different; Retail Carded	4	24	4-1/2in	1-3/4in	11cm	44mm

Government Locks

As the world's largest manufacturer of padlocks and portable security products, Master Lock has set the standard for quality and selection for more than 90 years. Building on this tradition, Master Lock continues to expand its commercial products and services to better meet our customers changing security requirements. Trust Master Lock for the innovative products, security, support and service you need.

Over the past 50 years Master Lock, as a prime contractor and subcontractor, has supplied every segment of Defense, Federal, State and Local Governments. Master Lock has over 85 National Stock Numbers (NSN) assigned to its product line. Through distribution Master Lock has in aggregate over 550 line items in GSA Advantage and 31 NSN line items referenced in DOD Email. Master Lock also supplies retail product to AAFES, Navy, Marines and the U.S.Coast Guard.

- Where required Master Lock products are designed to stringent government standards, CID-A-A-59486, CID-A-A-56487 and ASTM F883
- BumpStop® Advanced Cylinder Technology option provides excellent resistance to surreptitious attack
- Make-to-order capability – security products built and keyed to your requirements: shackle options, keying flexibility, laser engraving, key control and custom sets available
- 5-pin tumbler cylinder for added security
- More than 10,000 key changes available for maximum pick resistance
- Dual locking for superior pry resistance
- Most models are stamped "US"; sets are stamped "US SET"
- Non-removable keys available for added security

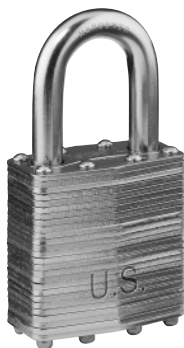

6001



6002



6004

Keying Options

- **Keyed Alike (KA)** - This provides insame keyin convenience and eliminates the need for multiple keys where numerous padlocks are used. All padlocks in the set are keyed the same. Most Master Lock padlocks can be ordered keyed alike. Keyed alike padlocks are listed in this price book with a "KA" suffix in the product number.
- **Master Keyed (MK)** - In a master keyed system, the master key opens all locks in the system although each lock has its own unique key. Master keyed items are ideal for permitting supervisory or emergency access. Master keyed padlocks are listed in this price book with an "MK" suffix in the product number.
- **Rekeyable Padlocks** - Padlock cylinders can be removed and replaced to restore security quickly without requiring a new padlock. This is ideal for situations where keys are lost or stolen due to theft or employee turnover. Rekeyable padlocks are found on pages 27-29.
- **Reserved Key Systems (RSV)** - Reserved key padlocks are not available to the general public and are not listed in this price book. Key blanks and cut keys are supplied directly by Master Lock through distributors and dealers when requested by registered end users. This adds security through the restricted distribution of duplicate keys. This option requires a custom quotation (see page 1).
- **Edge® Key Control** - Keys for this patent pending key control product offer the ultimate protection against unauthorized duplicate keys. Blank keys are available to locksmiths only and controlled by contract. These keys are recommended for all master keys applications. Contact your local locksmith for full details.
- **Non-Removable Key (NR)** - The key cannot be removed from the padlock when the padlock is open. This helps prevent users from accidentally leaving the padlock in the open position. Only selected padlocks offer this option.

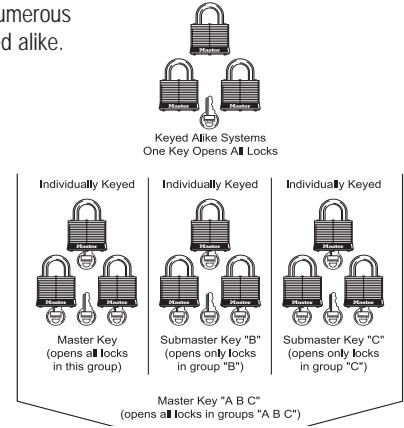

KEY CHARTING

- Customers can benefit fully from the large Master Lock change key ranges by having us chart your keying system for you. We will keep a complete record of the progressive key codes assigned and manufactured into your padlocks for each order. You will be assured that there is no unwanted key duplication with the padlocks you purchase over time. Be sure to request this special service with your next order so that all locks purchased from that point forward will be manufactured to comply with your key system requirements. Any orders placed by an end user or distributor should note that they are on a key charting system or reference their End User I.D. Number.

Key Number Range By Products

- Each Master Lock padlock has its own specific numbered key number. The products and appropriate key numbers are listed in the cut key listing, pages 56-57.
- To order a specific key number, specify product number followed by a key number. If no key number is indicated, Master Lock will select a random key number from the appropriate range.

Example: 12 No. 5KA = 12 No. 5 padlocks keyed alike to a randomly-selected key number in range A101-A2084
 12 No. 5KA A101 = 12 No. 5 padlocks keyed alike to key number A101

Padlock Options

- **Laser Engraving (LZ)** Laser Engraving allows for easy identification of padlocks that is a permanent mark on the padlock that cannot be removed. Some applications are: Safety Lock-out, Employee locker identification, Company logos for brand identification. Four areas on an Master Lock solid body aluminum and brass can be engraved for easy padlock identification. Numbers, letters, company logos, or alphanumeric characters can be added to a padlock. Logo engraving available in Area 1 & 3 only. There are a variety of type styles and sizes for text to choose from, or a customer can send a copy of their company logo and Master Lock can permanently engrave it on a padlock. Not recommended for clear locks. Contact Master Lock for order forms.
- **Other Stamping Options**
 - **Color Coding** - Some padlocks are available with colored bumpers or lock bodies for easy department identification.
 - **Chain and Tag Attachments** - Small chains may be attached to padlock shackles in order to affix padlocks to truck doors, gates, equipment, or other applications. Brass tags may be affixed to padlocks for identification purposes. These items are available separately. or can be attached at the factory.
 - **Reserved Key System (RSV)**

Key Stamping: Alpha numeric characters (HSK)*
I.D. Tag Tag Stamping: Alpha numeric characters (HST)
Interchangeable Core Stamping Concealed Side of Cylinder (CKC)
Ink Stamp Key Number on Bottom Plate (INK)
Hard Stamp Key Number on Bottom Plate (HSTP)

*Note: Key Stamping: (HSK) Alpha numeric characters (Priced PER KEY)

Service Parts — Padlock Cylinders

Example	296 KA W6000
Base Model	Description
297	Cylinder for Pro Series® Hockey Puck (Models 6270 & 6271) 1 unit/package , Shelf Pack = 6, Master Carton = 120
296	Cylinder for Pro Series® Padlocks (6121, 6125, 6127, 6321, 6325, 6327, 6830, 6835, 6840, 6850, 7030, 7040, 7045 & 7050 padlocks) 1 unit/package , Shelf Pack = 12, Master Carton = 240
295	4-pin and 5-pin Cylinders for Rekeyable Padlocks (21, 24, 25, 27, 101, 220 & 230 padlocks) 1 unit/package , Shelf Pack = 12, Master Carton = 240



BumpStop® Cylinder Technology	
N	Anti-Bump Cylinder Technology (<i>Not available with UN or KZ option</i>)

Keying	Standard: Keyed Different
UN	Uncombined (Zero bitted cylinder & no keys) - (Used exclusively with WP6 or WP4 options only)
KZ	Zero-Bitted
KA	Keyed Alike
MK	Master Keyed
KAMK	Keyed Alike; Master Keyed

Cylinder	REQUIRED CHOICE
W1	4-pin W1 cylinder (<i>296 & 295 Option Only</i>)
W1RSV	4-pin W1RSV cylinder (<i>295 Option Only</i>)
W2K	4-pin W2 cylinder (<i>295 Option Only</i>)
W15	5-pin W15 cylinder (<i>296 & 295 Option Only</i>)
W17	5-pin W17 cylinder (<i>296 & 295 Option Only</i>)
W27	5-pin W27 cylinder (<i>296 & 295 Option Only</i>)
W81	5-pin W81 cylinder (<i>296 & 295 Option Only</i>)
W81KM	5-pin W81KM cylinder (<i>295 & 296 Option Only</i>)
W81RSV	5-pin W81RSV cylinder (<i>295 & 296 Option Only</i>)
W6000	5-pin W6000 cylinder (<i>297 & 296 Option Only</i>)
W7000	6-pin W7000 cylinder (<i>297 & 296 Option Only</i>)
W7000NISI	6-pin W7000 cylinder (<i>297 & 296 Option Only</i>) with Nickel Silver Key
W600A	5-pin American Lock® W600A cylinder (<i>297, 296 & 295 Option Only</i>) (Available with KA & KZ option only)
W700A	6-pin American Lock® W700A cylinder (<i>297 & 296 Option Only</i>) (Available with KA & KZ option only)
WP4	Edge® Key Control 4-pin cylinder. Standard: Nickel Silver Keys (<i>297, 296 & 295 Option Only</i>)
WP6	Edge® Key Control 6-pin cylinder. Standard: Nickel Silver Keys (<i>297 & 296 Option Only</i>)

Hard Stamp	
HSK	Hard Stamp Key

Number of Keys	Standard: 2 keys per lock
1KEY	1 key per lock
3KEY	3 keys per lock
4KEY	4 keys per lock
NOKEY	0 keys per lock





■ Specify key code when ordering

Duplicate Cut Keys

Description			Key			
Lock Models	Cylinders	Key Numbers	OBSOLETE Cut Key Product Number			Units / Package (Each)
			Cut Regular	Cut Master	Control Keys	
Pin Tumbler Cut Keys						
Nos. 1, 2, 187, 475, 1803 and 1805	W1	2001 - 2997 X2000 - X2998	K1CR	K1CM	K1	1
Nos. 3, 4, 11, 34, 35, 36, 37, 39, 40, 190, 311, 312, 315, 317, 430, 443, 631 and 1317	W1	0301 - 0950 3030 - 3999	K1CR	K1CM	K1	1
Nos. 5 and 6	W1	A101 - A2084	K1CR	K1CM	K1	1
Nos. 1MK2K, 2MK2K, 3MK2K, 4MK2K, 5MK2K, 6MK2K and 11MK2K	W2K	Customer Provided	N/A	K2CM	K2	1
Nos. 1RSV, 2RSV, 3RSV, 4RSV, 5RSV and 6RSV	W1RSV	1C001 - 2C367	K1CRRSV	K1RSVCM	K1RSV	1
Nos. 7, 8, 90, 176, 185, 189, 716, 719 and 1807	W7	P104 - P851 K1973 - K2924	K7CR	K7CM	K7	1
Nos. 7RSV and 8RSV	W7RSV	7P001 - 7P672	K7CRRSV	K7RSVCM	K7RSV	1
No. 15, 220, and 230	W15	10N001 - 19N950	K15CR	K15CM	K15	1
No. 17	W17	10T001 - 19T599	K17CR	K17CM	K17	1
Nos. 21, 24, 25, 27, 31 and 101	W27	10L001 - 19L616	K27CR	K27CM	K27	1
Nos. 81, 82, 530, 532, 533, 570, 571, 991, 992 and 996	W81	10R01 - 10R10	K81KRCR	K81KMCM	K81	1
Nos. 81RSV and 82RSV	W81RSV	10X01 - 10X10	K81CRRSV	K81RSVCM	K81RSV	1
	W81KM	Customer Provided	—	—	K81KM	1
Nos. 911, 930 and 931	W900	10Z001 - 19Z950	K900CR	K900CM	K900	1
Pro Series® 5-pin standard cylinders	W6000	10G001 - 34G157	K6000CR	K6000CM	K6000	1
Pro Series® 6-pin standard cylinders	W7000	400K001 - 594K569	K7000CR	K7000CM	K7000	1
American Lock® 5-pin standard cylinders	W600A	Random	K600ACR	K600ACM	K600A	1
American Lock® 6-pin standard cylinders	W700A	Random	K700ACR	K700ACM	K700A	1
Edge® Key Control Products 6-pin cylinders	WP6	400XX001 - 594XX569	KWP6CR	KWP6CM	KWP6	1
Edge® Key Control Products 4-pin cylinders	WP4	2001XX - 2997XX X2000XX - X2998XX	KWP4CR	KWP4CM	KWP4	1
Key-In-Knob Duplicate Cut Keys (Please specify number when ordering)						
Falcon® (composite) Key - 5 Pin	D13	13T1001 - 13T9999	KD13CR	KD13CM	KD135	1
Kwikset® (composite) Key - 5 Pin	D12	12T1001 - 12T3422	KD12CR	KD12CM	KD125	1
Schlage® C Key - 5 Pin	D04	04T1001 - 04T9999	KD04CR	KD04CM	KD045	1
Schlage® C Key - 6 Pin	D04	04V10001 - 04V65536	KD04CR	KD04CM	KD046	1
Schlage® P Key - 5 Pin	D28	04T1001 - 04T9999	KD04CR	KD04CM	KD045	1
Schlage® P Key - 6 Pin	D28	04V10001 - 04V65536	KD04CR	KD04CM	KD046	1
Weiser® (composite) Key - 5 Pin	D13	13T1001 - 13T9999	KD13CR	KD13CM	KD135	1
Yale® 8 Key - 5 Pin	D03	03T1001 - 03T9999	KD03CR	KD03CM	KD035	1
Yale® 8 Key - 6 Pin	D03	03V10001 - 03V65536	KD03CR	KD03CM	KD036	1

Description			Key				
Lock Models	Cylinders	Key Numbers	OBSOLETE Cut Key Product Number			Units / Package (Each)	
			Cut Regular	Cut Master	Control Keys		
Interchangeable Core: Duplicate Cut Keys & Control Keys							
Standard "Y" Keyway	CY	Customer provided Key number stamped on original key.	KCYCR	KCYCR	KCYCONTROLKEY	KCY	1

KEY BLANKS: See pages 54-55 for respective key blanks or cut key information.

PP Unless otherwise specified, Shelf Pack = 6, Master Carton = 24 PP

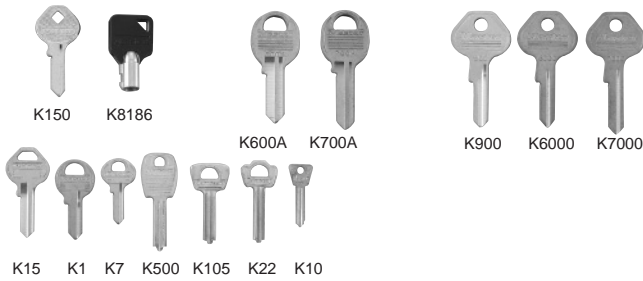

- Exact replacement blanks for genuine Master Lock keys
- Best choice for Universal Pin applications
- Blanks with black covered key heads also available
- Solid brass blanks are easy to cut and resist corrosion
- Blanks for American W600A and W700A cylinders available



Key Blanks

Commercial Products

Product Number	Description	Units (Per Box)
Standard Padlock Key Blanks		
K1BOX	For Nos. 1, 2, 3, 4, 5, 6, 11, 34, 35, 36, 37, 39, 40, 238, 255, 311, 312, 315, 317, 380 430, 443, 475, 613, 1317, 1377, 1472, 1473, 1474, 1479, 1480, 1481, 1803, 1805, 2848, 2866, 3774, 8401, 8413 and 8423 locks and Pro Series® locks with W1 cylinder option	50
K1RSVBOX	For Nos. 1, 2, 3, 4, 5, 6, 11, 311, 312, 317, 430 and 443 locks and Pro-Series® locks with W1RSV cylinder option	50
K2BOX	For Master Lock 5-pin, W2K cylinders in Nos. 1, 2, 3, 4, 5, 6 and 11 locks	50
K7BOX	For Nos. 7, 8, 90, 97, 716, 719, 1807, 8417, 8418 and 8419 locks	50
K7RSVBOX	For Nos. 7 and 8 locks	50
K15BOX	For No. 15, 220, and 230 locks and Pro Series® locks with W15 cylinder option	50
K17BOX	For No. 17 locks and Pro Series® locks with W17 cylinder option	50
K27BOX	For Nos. 21, 24, 25, 27, 31, 101, 220 and 230 locks and Pro Series® locks with W27 cylinder option	50
K81BOX	For Nos. 81, 82, 530, 532, 533, 570, 571, 575, 576, 751, 991, 992, 996, 1710 and 1714 locks and Pro Series® locks with W81 cylinder option	50
K81KMBOX	For Nos. 81 & 82 locks and Pro-Series® locks with 5-pin W81KM cylinder option	50
K81RSVBOX	For Nos. 81, 82 locks and Pro-Series® locks with 5-pin W81RSV cylinder option	50
K120BOX	For Nos. 120, 121, 1820, 1825 and 4120 locks	50
K130BOX	For Nos. 130, 131, 132, 133, 134, 135, 136, 140, 141, 142, 143, 144, 145, 146, 372, 605, 614, 631, 635, 645, 1830, 1840, 4130 and 4140 locks	50
K150BOX	For Nos. 150, 151, 160, 373, 527, 590, 640 and 4150 locks	50
K600BOX	For Master Lock products only utilizing a 5-pin, W600A standard American Lock cylinder	50
K700BOX	For Master Lock products only utilizing a 6-pin, W700A standard American Lock cylinder	50
K900BOX	For Nos. 911, 930, 931 and 937 locks	50
K6000BOX	For Master Lock 5-pin, W6000 cylinders	50
K7000BOX	For Master Lock 6-pin, W7000 cylinders	50
K7000NISIBOX	For Master Lock 6-pin, W7000 cylinders, Nickel Silver	50
KWP6BOX	For 6-pin Nickel Silver, Edge® Key Control. <i>Please specify Dimple Pattern & Identification Code</i>	50
KWP4BOX	For 4-pin Nickel Silver, Edge® Key Control. <i>Please specify Dimple Pattern & Identification Code</i>	50
K8121BOX	For No. 8118 locks	25
Warded Key Blanks		
K22LBOX	For No. 22 locks with left-hand corrugation	50
K22RBOX	For No. 22 locks with right-hand corrugation	50
K105BOX	For Nos. 105, 116 and 119 locks	50
K500LBOX	For Nos. 450 and 500 locks with left-hand corrugation	50
K500RBOX	For Nos. 450 and 500 locks with right-hand corrugation	50
K510BOX	For Nos. 510, 517 and 518 locks	50
Combination Change Keys		
K175BAG	For Nos. 175, 176, 177 and 178 locks	10
Small Format Interchangeable Core Blanks		
KCYBOX	Standard "Y" Keyway	50



- Contains extensive assortment of the most frequently used pin tumbler service components
- New case with deep storage compartments and sealing cover keeps parts in their place
- Convenient reference chart included
- Rekeying part refills may be ordered separately

Pin Tumbler Rekeying Kit

Commercial Products

Product Number	Description	Units (Per Kit or Bag)
Rekeying Kit		
291	Rekeying Kit	1

SPOOL PIN order no. 6121-0419	MASTER PIN No. 1 VIOLET order no. 1-0391	MASTER PIN No. 2 RED order no. 1-0392	MASTER PIN No. 3 BLUE order no. 1-0393	MASTER PIN No. 4 YELLOW order no. 1-0394	MASTER PIN No. 5 GREEN order no. 1-0395	MASTER PIN No. 6 BROWN order no. 1-0396	MASTER PIN No. 7 BLACK order no. 1-0397
No. 0 PIN BLACK order no. 1-0360	No. 1 PIN VIOLET order no. 1-0361	No. 2 PIN RED order no. 1-0362	No. 3 PIN BLUE order no. 1-0363	No. 4 PIN YELLOW order no. 1-0364	No. 5 PIN GREEN order no. 1-0365	No. 6 PIN BROWN order no. 1-0366	No. 7 PIN BLACK order no. 1-0367
New Style 6000 and 7000							
KEY CUT GAGES (order no. 290-0371) (order no. 290-0373)		DRIVER PIN order no. 0296-0323	SPOOL PIN order no. 0296-0322	E CLIPS order no. 0296-0324	DRIVER PIN MASTER order no. 7-0368		
CYLINDER ASSEMBLY TOOL (order no. 290-0372)		RETAINING NUT FOR #21 LOCK order no. 21-0373	RETAINING NUT FOR #27 LOCK order no. 27-0373	TRAP DOOR FOR #21 LOCK order no. 21	TRAP DOORS FOR PRO SERIES order no. 6121-0420	CYLINDER SLEEVE FOR 295 order no. 295	TUMBLER SPRINGS order no. 1-0369
ALLEN WRENCHES 3/32" (order no. 21-0374) 7/64" (order no. 27-0374)		RETAINING NUT PRO SERIES (ALL) order no. 6121-0421		TRAP DOOR FOR #25 LOCK order no. 25	TRAP DOORS FOR PRO SERIES order no. 6830-0023	CYLINDER SLEEVE FOR 295 order no. 295	
REKEYABLE DISCUS CYLINDER REMOVAL TOOL (order no. PKG P38528)							

KEY BLANKS: See pages 54-55 for respective key blanks or cut key information.

PP Unless otherwise specified, Shelf Pack = 6, Master Carton = 24 PP

Rekeying Parts *(continued)*

Commercial Products			
Product Number	Description	List Price	Units (Per Kit or Bag)
Cylinder Pins - Regular			
0001-0360	#0 Pin (Black)		200
0001-0361	#1 Pin (Violet)		200
0001-0362	#2 Pin (Red)		200
0001-0363	#3 Pin (Blue)		200
0001-0364	#4 Pin (Yellow)		200
0001-0365	#5 Pin (Green)		200
0001-0366	#6 Pin (Brown)		200
0001-0367	#7 Pin (Black)		200
Cylinder Pins - Master			
0001-0391	#1 Master Pin (Violet)		200
0001-0392	#2 Master Pin (Red)		200
0001-0393	#3 Master Pin (Blue)		200
0001-0394	#4 Master Pin (Yellow)		200
0001-0395	#5 Master Pin (Green)		200
0001-0396	#6 Master Pin (Brown)		200
0001-0397	#7 Master Pin (Black)		200
Driver Pins & Tumbler Springs			
0296-0322	Spool Pins For 6000B and 7000B cylinders		200
0296-0323	Driver Pin For 6000B and 7000B cylinders		200
6121-0419	Driver Pins - Spool Design (Regular)		200
0001-0368	Driver Pins (Regular)		200
0007-0368	Driver Pins - Non Spool Design (Master)		200
0001-0369	Tumbler Springs, Stainless Steel		200
Miscellaneous Cylinder Parts			
0296-0324	E Clip for 6000B and 7000B		12
0296-0200	Edge® Cylinder Ball Bearings, 3/32in Diameter		200
APKG0049816	Edge® Cylinder Set screw, 5-40 x 1/8in Socket		100
No. 295 Cylinder Sleeve	Stainless Steel Cylinder Sleeve for 295		10
Pro Series® Shells & Plugs			
6121-0390	Cylinder Shells For Pro Series® W1, W15, W17, W27, W81KR, W81MK, and W6000 cylinders only		12
6121-0391	Cylinder Shells For Pro Series® W600A and W700A cylinders only		12
6121-0400	Cylinder Plugs For Pro Series® W1 cylinders only		12
6121-0401	Cylinder Plugs For Pro Series® W15 cylinders only		12
6121-0402	Cylinder Plugs For Pro Series® W17 cylinders only		12
6121-0403	Cylinder Plugs For Pro Series® W27 cylinders only		12
6121-0404	Cylinder Plugs For Pro Series® W81 cylinders only		12
6121-0405	Cylinder Plugs For Pro Series® W81KM cylinders only		12
6121-0406	Cylinder Plugs For Pro Series® W600A and W700A cylinders only		12
6121-0407	Cylinder Plugs For Pro Series® W6000 and W7000 cylinders only		12
Stainless Steel Ball Bearings			
0220-0302	For Pro Series® locks Nos. 6830, 6831, and 6835 (Curved Body) locks		10
6121-0427	For all Pro Series® locks except Nos. 6830, 6831, and 6835 (Curved Body) locks		12
APKG1806010	Stainless Steel ¼in (6mm) Diameter, for No 6835 (Rectangular Body)		12

Rekeying Parts *(continued)*
Commercial Products

Product Number	Description	Units (Per Kit or Bag)
Actuators		
6121-0423	Non-Key Retaining Actuator For Nos. 6100, 6300, 6400, 6500, 6600, 6700, 7042, 7047 & 7052 series locks	6
6121-0424	Non-Removable Key Actuator For Nos. 6100, 6300, 6400, 6500, 6600, 6700, 6841, 6842, 6851, 6852, 7040, 7041, 7042, 7045, 7046, 7047, 7050, 7051 & 7052 series locks	6
6121-0425	Non-Key Retaining Actuator For No. 6230 lock	6
6121-0426	Non-Removable Key Actuator For No. 6230 lock	6
6421-0451	SFIC Throw Member For Pro Series® Small Format Interchangeable Core (SFIC) Series 6421, 6427, 6521, 6527, 6831, 6836, 6841, 6851, 7031, 7036, 7041, 7046 and 7051 locks	6
6421-0452	SFIC Actuator Retainer For Pro Series® Small Format Interchangeable Core (SFIC) Series 6421, 6427, 6521, 6527, 6831, 6836, 6841, 6851, 7031, 7036, 7041, 7046 and 7051 locks	6
6421-0453	SFIC Retainer Clip For Pro Series® Small Format Interchangeable Core (SFIC) Series 6421, 6427, 6521, 6527, 6831, 6836, 6841, 6851, 7031, 7036, 7041, 7046 and 7051 locks	6
6830-0421	Non-Key Retaining Actuator For Nos. 6830 locks	6
6831-0421	Non-Key Retaining Actuator For Nos. 6831, 6835 (Curved Body), 6836, 7030, 7031, 7035 and 7036 locks	6
6830-0422	Non-Removable Key Actuator For Nos. 6830, 6831, 6835 (Curved Body), 6836, 7030, 7031, 7035 & 7036 locks	6
6841-0421	Non-Key Retaining Actuator For Nos. 6840, 6841, 6842, 6850, 6851, 6852, 7040, 7041, 7045, 7050 and 7051 locks	6
APKG0001669	Non-Key Retaining Actuator, For No. 6835 (Rectangular body)	6
APKG0001670	Non-Removable Key Actuator, For No. 6835 (Rectangular body)	6
Cylinder Retaining Trap Doors, Covers, Nuts & Screws		
Pro Series®		
6121-0420	Retainer Trap Door For Nos. 6121, 6125, 6127, 6230, 6321, 6325, 6327, 6840, 6850, 7035, 7040, 7045 and 7050 locks	12
6830-0420	Retainer Trap Door For Nos. 6830, 6835 (Curved Body) and 7030 locks	12
6121-0421	Locking Nut For Nos. 6121, 6125, 6127, 6230, 6321, 6325, 6327, 6830, 6835 (Curved Body), 6840, 6850, 7030, 7035, 7040, 7045 and 7050 locks	12
6121-0422	Retainer Screw For Nos. 6121, 6125, 6127, 6230, 6321, 6325, 6327, 6830, 6835 (Curved Body), 6840, 6850, 7030, 7035, 7040, 7045 and 7050 locks	12
APKG4680210	Trap Door for No. 6835 (Rectangular Body) for W2K, W17, W81, W81KM, W417, W427, W481, W600A, W700A	10
APKG4680220	Trap Door for No. 6835 (Rectangular Body) for keyways W1, W1RSV, W15, W81RSV, W400, W401, W410, W6000, W7000, WP4, WP6	10
APKG4746010	Nut, Security, For No. 6835 (Rectangular Body)	25
APKG4761010	Screw, Security, For No. 6835 (Rectangular Body)	25
Rekeyable Laminated		
0021-0372	Cylinder Retaining Trap Door For No. 21 locks	10
0021-0373	Locking Nuts For Nos. 21 and 101 locks	10
0024-0372	Cylinder Retaining Trap Door For No. 24 locks	10
0024-0373	Locking Nuts For No. 24 locks	10
0021-0305	Retainer Screw For Nos. 21, 24, and 101 locks	10
0027-0371	Cylinder Retaining Trap Door For No. 25 locks	10
0027-0373	Locking Nuts For Nos. 25 and 27 locks	10
0027-0305	Retainer Screw For Nos. 25 and 27 locks	10
0101-0372	Cylinder Retaining Trap Door For No. 101 locks	10
Tools & Gauges		
0021-0374	Hex Wrenches (3/32in)	10
0027-0374	Hex Wrenches (7/64in)	10
0290-0371	Key Cut Gauge For Flat Back Keys	10
0290-0373	Key Cut Gauge For 6000B and 7000B Round Back Keys	10
0290-0372	Cylinder Assembly Tool	10
0290-0630	Set of Depth Keys For Nos. 1, 2, 3, 4, 5, 6, 15, 17, 21, 24, 25, and 27 locks	5
0290-0631	Set of Depth Keys For Nos. 81 and 82 locks	5
0290-60612	Edge® Follower	1
APKG0062260	1/16in Allen Wrench	1

KEY BLANKS: See pages 54-55 for respective key blanks or cut key information.

PP Unless otherwise specified, Shelf Pack = 6, Master Carton = 24 PP

Padlock Chains, Tags & Collars

Commercial Products		
Product Number	Description	Units (Per Kit or Bag)
Padlock Chains & Identification Tags		
71CS	9in (23cm) long lightweight zinc plated steel chain with chain holder attached. Fits all Master Lock shackles & shackle collars. Shackle collars must be ordered separately.	12
71CH	9in (23cm) long heavy-duty zinc plated steel chain with chain holder attached. Fits all Master Lock shackles & shackle collars. Shackle collars must be ordered separately.	12
71SHKS	Chains with "S" Hooks, 9in (23cm) chain with pair of mounting "S" hooks.	12
71TAG	Brass Identification Tags, 1/2in x 1-3/4in (13mm x 44mm) brass tag with ring for attaching to shackle collars listed below	12
Shackle Collars		
71SC7	Fits 7/32in (6mm) diameter shackles and smaller For Nos. 7, 7LF, 7LF, 8, 8LF, 105 and 105LF locks; includes rivets	12
71SC8	Fits 1/4in (6mm) diameter shackles and smaller For Nos. 22 and 22LF, 410, 411, 6830, 6831, 6835, 6836, 7030 & 7031 locks, Also for American Lock® Nos. A1105, A1106, A1107, A1165, A1166, A1167 locks; includes rivets	12
71SC9	Fits 9/32in (7mm) diameter shackles and smaller For Nos. 3, 3LF, 3LH, 4, 4LF, 4LH, 11, 500, 500LF, 1500 series & 1525 locks; includes rivets	12
71SC10	Fits 5/16in (8mm) diameter shackles and smaller For Nos. 1, 1LF, 1LJ, 1LN, 2, 2LF, 2LJ, 21, 21LF, 21LJ, 21LN, 24, 24LF, 24LJ, 24LN, 81, 81LF, 81LJ, 81LN, 82, 82LF, 82LJ, 101, 175, 175LH, 2001, 2002, 2010, 6121, 6840, 6841, 6842, 7040, 7041 and 7042 locks; includes rivets.	12
71SC12	Fits 3/8in (10mm) diameter shackles and smaller For Nos. 5, 5LF, 5LJ, 6, 6LF, 6LJ, 25, 25LF, 25LJ, 6125, 6850, 6851, 6852, 7050, 7051 and 7052 locks; includes rivets	12
71SC14	Fits 7/16in (11mm) diameter shackles and smaller For Nos. 15, 17, 220, 220LH, 230, 230LH, 27, 27LH, 6230 and 6327 locks; includes rivets.	12

Shackles for Rekeyable Padlocks

Commercial Products		
Product Number	Description	Units/Package
Pro Series® Padlock Shackles & Shackle Springs		
1/4in (6mm) Diameter		
293S6830	Boron, 1-1/8in (29mm) vertical clearance shackles For Nos. 6830, 6831, 6835 (Curved Body), 6836, 7030, 7031 Pro Series® padlocks	6
293LFS6830	Boron, 1-9/16in (40mm) vertical clearance shackles For Nos. 6830, 6831, 6835 (Curved Body), 6836, 7030, 7031 Pro Series® padlocks	6
5/16in (8mm) Diameter		
293S6121	Boron, 1-1/8in (29mm) vertical clearance shackles For Nos. 6121, 6421, 6621, 6840, 6841, 6842, 7040, 7041, 7042 Pro Series® padlocks	6
293LFS6121	Boron, 1-1/2in (38mm) vertical clearance shackles For Nos. 6121, 6421, 6621, 6840, 6841, 6842, 7040, 7041, 7042 Pro Series® padlocks	6
293LJS6121	Boron, 2-3/8in (60mm) vertical clearance shackles For Nos. 6121, 6421, 6621, 6840, 6841, 6842, 7040, 7041, 7042 Pro Series® padlocks	6
Pro Series® Padlock Shackles & Shackle Springs (continued)		
5/16in (8mm) Diameter (continued)		
293S6321	Boron, 3/4in (19mm) vertical clearance shackles for Nos. 6321, 6521, 6721 Pro Series® padlocks	6
3/8in (10mm) Diameter		
293S6125	Boron, 1-3/8in (35mm) vertical clearance shackles For Nos. 6125, 6850, 6851, 6852, 7050, 7051, 7052 Pro Series® padlocks	6
293LJS6125	Boron, 2-3/8in (60mm) vertical clearance shackles For Nos. 6125, 6850, 6851, 6852, 7050, 7051, 7052 Pro Series® padlocks	6
293S6325	Boron, 3/4in (19mm) vertical clearance shackles For No. 6325 Pro Series® padlocks	6
7/16in (11mm) Diameter		
293S6127	Boron, 1-3/8in (35mm) vertical clearance shackles For Nos. 6127, 6427, 6627 Pro Series® padlocks	6
293LHS6127	Boron, 1-7/8in (48mm) vertical clearance shackles For Nos. 6127, 6427, 6627 Pro Series® padlocks	6
293LJS6127	Boron, 2-3/8in (60mm) vertical clearance shackles For Nos. 6127, 6427, 6627 Pro Series® padlocks	6
293S6327	Boron, 3/4in (19mm) vertical clearance shackles For Nos. 6327, 6527, 6727 Pro Series® padlocks	6
293S6230	Boron, 1-1/8in (29mm) vertical clearance shackles For No. 6230 Pro Series® padlocks	6
293LHS6230	Boron, 2in (51mm) vertical clearance shackles For No. 6230 Pro Series® padlocks	6
No. 443 Shackles		
292LES443	Steel, 7/8in (22mm) vertical clearance shackles	5

Nos. 220 & 230 Service Parts

Commercial Products		
Product Number	Description	Units (Per Kit or Bag)
General Parts for Nos. 220 and 230 Locks		
0230-0304	Key Return Springs	10
0230-0306	Shackle Springs	10
0230-0334	Plug Extension For W1 cylinders	10
0230-1325	Non Key Retaining Actuator for a 4 pin cylinder	1
0230-1326	Non Removable Key Actuator for a 4 pin cylinder	1
0021-0374	Hex Wrenches (3/32in)	10
No. 220 Specific Service Parts		
0220-0300	Deadbolt Pins	10
0220-0301	Anti-Saw Pins	10
0220-0302	Locking Balls	10
0220-0303	Shackle Stop Pins	10
0220-0305	Retainer Screws	10
292S220	Boron, 7/16in (11mm) Diameter Shackles, 1in (25mm) vertical shackle clearance	5
292LHS220	Boron, 7/16in (11mm) Diameter Shackles, 2in (51mm) vertical shackle clearance	5
No. 230 Specific Service Parts		
0230-0300	Deadbolt Pins	10
0230-0301	Anti-Saw Pins	10
0230-0302	Locking Balls	10
0230-0303	Shackle Stop Pins	10
0230-0305	Retainer Screws	10
292S230	Boron, 7/16in (11mm) Diameter Shackles, 1in (25mm) vertical shackle clearance	5
292LHS230	Boron, 7/16in (11mm) Diameter Shackles, 2in (51mm) vertical shackle clearance	5

Door Key Compatible Parts

Cylinder Drivers		
0298-0625	For Lockwood® Australia Cylinder	6
0298-0626	For Lori® Cylinder #1539 6-pin cylinder for inAin series knob sets	6
0298-0627	For Medeco® Cylinder #20W200 6-pin cylinder for inAin series knob sets	6
0298-0628	For Schlage® 6-pin cylinder for inAin series knob sets	6
0298-0630	Assortment Pack; six each of Lori® 1539, Medeco® & Schlage® drivers	18
Cylinder Retainer Plugs & Screws		
0298-0629	Cylinder Retainer Plugs	6
6621-0450	Retainer Screw For Series 6600 and 6700 and No. 6852 locks	12

Interested in more security products?

Explore Master Lock's wide range of innovative products across all categories. From industrial safety solutions to locker security, to door entry security there's a solution for every customer need – on the jobsite, at the office or in the field.

DOOR HARDWARE PRODUCTS

Residential Door Hardware, Commercial Door Hardware, Multi-Family Door Hardware, Electronic Door Hardware.



LOCKER AND STORAGE SECURITY PRODUCTS

ADA Solutions, Multi-User Combination Locks, Built-In Combination Locks, Built-In Keyed Locks, Portable Combination Locks.



SAFETY SOLUTIONS PRODUCTS

Safety Padlocks, Lockout Devices, Safety Identification Signs and Tags.



COMMERCIAL CARDED PRODUCTS

ProSeries® Padlocks, ProSeries® Resettable Combination Padlocks, ProSeries® Recodable Solid Steel Padlocks, Commercial Laminated Steel Padlocks.



CONSUMER SECURITY RETAIL CARDED PRODUCTS

Laminated Padlocks, Brass Laminated Padlocks, Shrouded Padlocks, Solid Body Padlocks, Combination Padlocks, Carabiners, TSA Accepted Luggage Locks, Gun Locks.



A7A3
CAPACITORS



Safety Solutions

Master Lock offers the most comprehensive line of safety products available. We have a product that's built for every type of environment, and a lockout solution for every isolation point.

Safety padlocks answer unique facility and identification needs as well as compliance regulations



ZENEX™ THERMOPLASTIC PADLOCKS
Durable, lightweight padlocks withstand extreme temperature, UV and corrosive chemicals

EXTREME ENVIRONMENT
3/16" (4.8mm) stainless steel shackles are optimal for corrosive environments



DIELECTRIC SAFETY PADLOCKS
Non-conductive, non-sparking, and non-magnetic materials ideal for electrical lockout applications



ANODIZED ALUMINUM PADLOCKS
Durable padlocks withstand any harsh environments. Ideal for food processing facilities, oil & gas and mining applications



LAMINATED STEEL PADLOCKS
Proven, economical padlocks stand up to physical abuse

Lockout devices help to easily solve challenging applications



Tags & Labels



Hasps



Stations & Kits

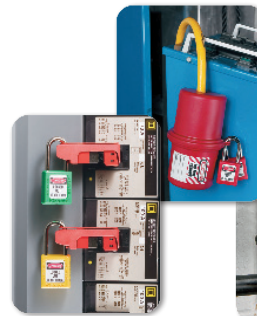

Electrical Lockouts



Valve Lockouts



Group Lock Boxes



Cable Lockouts

PRICE BOOK CONTENTS

TERMS OF SALE	1
ORDERING INFORMATION.....	1
EXPRESS PROGRAM.....	3
SPEED PRICE LIST	4
PROFESSIONAL LOCKOUT SERVICES.....	11
PADLOCKS, ACCESSORIES AND IDENTIFICATION	
■ Zenex™ Thermoplastic Safety Padlocks	12
■ American Lock® Aluminum Safety Padlocks.....	16
■ Steel Safety Padlocks	18
■ American Lock® IC Aluminum Safety Padlocks ...	20
■ Specialty Padlocks	
Circuit Breaker Switch Padlock	21
Breakaway Shackle Padlock	21
■ Extreme Environment Padlock Covers	21
■ Padlock Accessories	21
■ Padlock Labels	21
■ Multilingual Padlock Labels	22
LOCKOUT DEVICES	
■ Lockout Hasps.....	22
■ Cable Lockouts.....	22
■ Valve Lockouts.....	23
■ Blind Lockouts	23

LOCKOUT DEVICES CONT.	
■ Pneumatic Lockouts	23
■ Stainless Steel Group Lock Boxes.....	24
■ Steel Group Lock Boxes.....	25
■ Electrical Lockouts	25
■ Switch, Plug, Control & Button Covers	26
■ Lockout Kits.....	26
■ Lockout Stations	27
■ Compact Lockout Stations.....	27
■ Padlock Stations	28
■ Padlock Racks.....	28
■ Tag Stations.....	28
TAGS	
■ Guardian Extreme™ Tags	29
■ Self Laminating Tags	29
■ Boxed Roll of Tags.....	29
■ Maintenance Tags	29
KEY CABINETS	
■ SAFESPACE® Heavy Duty Key Cabinets	30
■ SAFESPACE® Key Tags and Hangers.....	30
SAFETY LOCKOUT PLANOGRAMS	31

SPEED INDEX

These pages are provided as a convenience. In the case of a discrepancy between what is shown here and what is calculated using the padlock configuration pages, the configured price takes precedence.

Product Number	Page Number	Shelf Pack Quantity	Master Carton Quantity
0411-5705	21	1	1
3BLK	18	6	24
3BLU	18	6	24
3GRN	18	6	24
3KABLK	18	6	24
3KABLU	18	6	24
3KAGR	18	6	24
3KALFBLK	18	6	24
3KALFBLU	18	6	24
3KALFGRN	18	6	24
3KALFRED	18	6	24
3KALFWHT	18	6	24
3KALFYLW	18	6	24
3KALHBLK	18	6	24
3KALHBLU	18	6	24
3KALHGRN	18	6	24
3KALHRED	18	6	24
3KALHWHT	18	6	24
3KALHYLW	18	6	24
3KAMK Series	18	6	24
3KARED	18	6	24
3KAS series	19	—	—
3KAWHT	18	6	24
3KAYLW	18	6	24
3LFBLK	18	6	24
3LFBLU	18	6	24
3LFGRN	18	6	24
3LFRED	18	6	24
3LFWHT	18	6	24
3LFYLW	18	6	24
3LHBLK	18	6	24
3LHBLU	18	6	24
3LHGRN	18	6	24
3LHRED	18	6	24
3LHWHT	18	6	24
3LHYLW	18	6	24
3MK Series	18	6	24
3RED	18	6	24
3WHT	18	6	24
3YLW	18	6	24
7C5RED	21	6	24
71CS	21	1	1
71SC7	21	1	1
71SC8	21	1	1
71TAG	21	1	1
406BLK	14	6	36

Product Number	Page Number	Shelf Pack Quantity	Master Carton Quantity
406BLU	14	6	36
406GRN	14	6	36
406KABLK	14	6	36
406KABLU	14	6	36
406KAGR	14	6	36
406KAMK Series	14	6	36
406KAORJ	14	6	36
406KAPRP	14	6	36
406KARED	14	6	36
406KAS Series	15	—	—
406KATEAL	14	6	36
406KAYLW	14	6	36
406MK Series	14	6	36
406ORJ	14	6	36
406PRP	14	6	36
406RED	14	6	36
406TEAL	14	6	36
406YLW	14	6	36
410BLK	14	6	36
410BLU	14	6	36
410DRED	31	—	6
410GRN	14	6	36
410KABLK	14	6	36
410KABLU	14	6	36
410KAGR	14	6	36
410KALTBLK	14	6	36
410KALTBLU	14	6	36
410KALTGRN	14	6	36
410KALTORJ	14	6	36
410KALTPRP	14	6	36
410KALTRED	14	6	36
410KALTTEAL	14	6	36
410KALTYLW	14	6	36
410KAMK Series	14	6	36
410KAORJ	14	6	36
410KAPRP	14	6	36
410KARED	14	6	36
410KAS Series	15	—	—
410KATEAL	14	6	36
410KAYLW	14	6	36
410LTBLK	14	6	36
410LTBLU	14	6	36
410LTGRN	14	6	36
410LTORJ	14	6	36
410LTPRP	14	6	36
410LTRED	14	6	36

SPEED INDEX

Product Number	Page Number	Shelf Pack Quantity	Master Carton Quantity
410LTTEAL	14	6	36
410LTYLW	14	6	36
410MK Series	14	6	36
410ORJ	14	6	36
410PRP	14	6	36
410RED	14	6	36
410TEAL	14	6	36
410TRIRED	31	—	6
410YLW	14	6	36
411BLK	14	6	36
411BLU	14	6	36
411GRN	14	6	36
411KABLK	14	6	36
411KABLU	14	6	36
411KAGRN	14	6	36
411KALTBK	14	6	36
411KALTBLU	14	6	36
411KALTGRN	14	6	36
411KALTORJ	14	6	36
411KALTPRP	14	6	36
411KALTRED	14	6	36
411KALTTEAL	14	6	36
411KALTYLW	14	6	36
411KAMK Series	14	6	36
411KAORJ	14	6	36
411KAPRP	14	6	36
411KARED	14	6	36
411KAS Series	15	—	—
411KATEAL	14	6	36
411KAYLW	14	6	36
411LTBLK	14	6	36
411LTBLU	14	6	36
411LTGRN	14	6	36
411LTORJ	14	6	36
411LTPRP	14	6	36
411LTRED	14	6	36
411LTTEAL	14	6	36
411LTYLW	14	6	36
411MK Series	14	6	36
411ORJ	14	6	36
411PRP	14	6	36
411RED	14	6	36
411TEAL	14	6	36
411YLW	14	6	36
416	22	12	72
417	22	12	72
418	22	12	72
419	22	12	72

Product Number	Page Number	Shelf Pack Quantity	Master Carton Quantity
420	22	12	72
420D	31	—	6
421	22	12	72
427	22	6	24
428	22	12	72
429	22	12	72
453L	26	1	6
453XL	26	1	6
461	21	1	6
468L	23	1	6
480	23	1	6
480D	31	—	6
481	23	1	6
482	23	1	6
483	23	1	6
484	23	1	6
485	23	1	1
487	25	1	6
487D	31	—	6
488	25	1	6
491B	25	6	24
493B	25	6	24
496B	26	6	24
496BD	31	—	6
497A	29	1	160
497ABLC	29	1	160
497AD	31	—	6
497AX	29	1	160
498A	25	1	1
498AALTAGLZ1	25	1	1
498ATAGLZ1	25	1	1
500KABRK	21	12	72
503RED	25	1	1
503YLW	25	1	1
506	25	6	24
506D	31	—	6
1336ELECT	31	—	1
1336PLMB	31	—	1
1337LGENIND	31	—	1
1337SMGENIND	31	—	1
1456	26	1	4
1457E410KA	26	1	1
1457V410KA	26	1	1
1457VE410KA	26	1	1
1458	26	1	1
1458E410	26	1	1
1458VE410	26	1	1
1482B	28	1	1

SPEED INDEX

Product Number	Page Number	Shelf Pack Quantity	Master Carton Quantity
1482BES	28	1	1
1482BFRC	28	1	1
1482BP410	28	1	1
1482BP410ES	28	1	1
1482BP410FRC	28	1	1
1482BP1106	28	1	1
1482BP1106ES	28	1	1
1482BP1106FRC	28	1	1
1483B	28	1	1
1483BES	28	1	1
1483BFRC	28	1	1
1483BP410	28	1	1
1483BP410ES	28	1	1
1483BP410FRC	28	1	1
1483BP1106	28	1	1
1483BP1106ES	28	1	1
1483BP1106FRC	28	1	1
1484B	28	1	1
1484BES	28	1	1
1484BFRC	28	1	1
1484BP410	28	1	1
1484BP410ES	28	1	1
1484BP410FRC	28	1	1
1484BP1106	28	1	1
1484BP1106ES	28	1	1
1484BP1106FRC	28	1	1
6835-5700	21	1	1
6835-5701	21	1	1
6835BLK	—	repl. by A1105KABLK	
6835BLU	—	repl. by A1105KABLU	
6835GRN	—	repl. by A1105KAGRN	
6835KABLK	—	repl. by A1105KABLK	
6835KABLU	—	repl. by A1105KABLU	
6835KAGRN	—	repl. by A1105KAGRN	
6835KALFBLK	—	repl. by A1106KABLK	
6835KALFBLU	—	repl. by A1106KABLU	
6835KALFGRN	—	repl. by A1106KAGRN	
6835KALFORJ	—	repl. by A1106KAORJ	
6835KALFRED	—	repl. by A1106KARED	
6835KALFYLW	—	repl. by A1106KAYLW	
6835KALTBLK	—	repl. by A1107KABLK	
6835KALTBLU	—	repl. by A1107KABLU	
6835KALTGRN	—	repl. by A1107KAGRN	
6835KALTORJ	—	repl. by A1107KAORJ	
6835KALTRED	—	repl. by A1107KARED	
6835KALTYLW	—	repl. by A1107KAYLW	
6835KAMK Series	—	repl. by A1105KAMK Series	
6835KAORJ	—	repl. by A1105KAORJ	

Product Number	Page Number	Shelf Pack Quantity	Master Carton Quantity
6835KARED	—	repl. by A1105KARED	
6835KAS Series	—	repl. by A1105KAS Series	
6835KAYLW	—	repl. by A1105KAYLW	
6835LFBLK	—	repl. by A1106BLK	
6835LFBLU	—	repl. by A1106BLU	
6835LFGRN	—	repl. by A1106GRN	
6835LFORJ	—	repl. by A1106ORJ	
6835LFRED	—	repl. by A1106RED	
6835LFYLW	—	repl. by A1106YLW	
6835LTBLK	—	repl. by A1107BLK	
6835LTBLU	—	repl. by A1107BLU	
6835LTGRN	—	repl. by A1107GRN	
6835LTORJ	—	repl. by A1107ORJ	
6835LTRED	—	repl. by A1107RED	
6835LTYLW	—	repl. by A1107YLW	
6835MK Series	—	repl. by A1105MK Series	
6835ORJ	—	repl. by A1105ORJ	
6835RED	—	repl. by A1105RED	
6835YLW	—	repl. by A1105YLW	
7116D	30	—	10
7117D	30	—	10
7125D	30	—	4
7126D	30	—	4
A1105BLK	16	6	24
A1105BLU	16	6	24
A1105BRN	16	6	24
A1105CLR	16	6	24
A1105GRN	16	6	24
A1105KABLK	16	6	24
A1105KABLU	16	6	24
A1105KABRN	16	6	24
A1105KACLR	16	6	24
A1105KAGRN	16	6	24
A1105KAMK Series	16	6	24
A1105KAORJ	16	6	24
A1105KAPRP	16	6	24
A1105KARED	16	6	24
A1105KAS Series	17	—	—
A1105KAYLW	16	6	24
A1105MK Series	16	6	24
A1105ORJ	16	6	24
A1105PRP	16	6	24
A1105RED	16	6	24
A1105YLW	16	6	24
A1106BLK	16	6	24
A1106BLU	16	6	24
A1106BRN	16	6	24
A1106CLR	16	6	24

SPEED INDEX

Product Number	Page Number	Shelf Pack Quantity	Master Carton Quantity
A1106GRN	16	6	24
A1106KABLK	16	6	24
A1106KABLU	16	6	24
A1106KABRN	16	6	24
A1106KACLR	16	6	24
A1106KAGRN	16	6	24
A1106KAMK Series	16	6	24
A1106KAORJ	16	6	24
A1106KAPRP	16	6	24
A1106KARED	16	6	24
A1106KAS Series	17	—	—
A1106KAYLW	16	6	24
A1106MK Series	16	6	24
A1106ORJ	16	6	24
A1106PRP	16	6	24
A1106RED	16	6	24
A1106YLW	16	6	24
A1107BLK	16	6	24
A1107BLU	16	6	24
A1107BRN	16	6	24
A1107CLR	16	6	24
A1107GRN	16	6	24
A1107KABLK	16	6	24
A1107KABLU	16	6	24
A1107KABRN	16	6	24
A1107KACLR	16	6	24
A1107KAGRN	16	6	24
A1107KAMK Series	16	6	24
A1107KAORJ	16	6	24
A1107KAPRP	16	6	24
A1107KARED	16	6	24
A1107KAYLW	16	6	24
A1107MK Series	16	6	24
A1107ORJ	16	6	24
A1107PRP	16	6	24
A1107RED	16	6	24
A1107YLW	16	6	24
A1165 Series	16	6	24
A1166 Series	16	6	24
A1167 Series	16	6	24
A3105 Series	20	6	24
A3106 Series	20	6	24
A3107 Series	20	6	24
ALO80	22	12	72
ALO802	22	12	72
S30COVERS	21	1	1
S31BLK	12	6	36
S31BLU	12	6	36

Product Number	Page Number	Shelf Pack Quantity	Master Carton Quantity
S31GRN	12	6	36
S31KABLK	12	6	36
S31KABLU	12	6	36
S31KAGRN	12	6	36
S31KALTBK	12	6	36
S31KALTBLU	12	6	36
S31KALTGRN	12	6	36
S31KALTORJ	12	6	36
S31KALTPRP	12	6	36
S31KALTRED	12	6	36
S31KALTTEAL	12	6	36
S31KALTYLW	12	6	36
S31KALTWHT	12	6	36
S31KAORJ	12	6	36
S31KAPRP	12	6	36
S31KARED	12	6	36
S31KAS Series	13	—	—
S31KATEAL	12	6	36
S31KAYLW	12	6	36
S31KAWHT	12	6	36
S31LTBLK	12	6	36
S31LTBLU	12	6	36
S31LTGRN	12	6	36
S31LTORJ	12	6	36
S31LTPRP	12	6	36
S31LTRED	12	6	36
S31LTTEAL	12	6	36
S31LTYLW	12	6	36
S31LTWHT	12	6	36
S31ORJ	12	6	36
S31PRP	12	6	36
S31RED	12	6	36
S31TEAL	12	6	36
S31YLW	12	6	36
S31WHT	12	6	36
S32BLK	12	6	36
S32BLU	12	6	36
S32GRN	12	6	36
S32KABLK	12	6	36
S32KABLU	12	6	36
S32KAGRN	12	6	36
S32KAORJ	12	6	36
S32KAPRP	12	6	36
S32KARED	12	6	36
S32KATEAL	12	6	36
S32KAYLW	12	6	36
S32KAWHT	12	6	36
S32ORJ	12	6	36

SPEED INDEX

Product Number	Page Number	Shelf Pack Quantity	Master Carton Quantity
S32PRP	12	6	36
S32RED	12	6	36
S32TEAL	12	6	36
S32YLW	12	6	36
S32WHT	12	6	36
S33BLK	12	6	36
S33BLU	12	6	36
S33GRN	12	6	36
S33KABLK	12	6	36
S33KABLU	12	6	36
S33KAGRN	12	6	36
S33KALTBK	12	6	36
S33KALTBLU	12	6	36
S33KALTGRN	12	6	36
S33KALTORJ	12	6	36
S33KALTPRP	12	6	36
S33KALTRED	12	6	36
S33KALTTEAL	12	6	36
S33KALTYLW	12	6	36
S33KALTWHT	12	6	36
S33KAORJ	12	6	36
S33KAPRP	12	6	36
S33KARED	12	6	36
S33KAS Series	13	—	—
S33KATEAL	12	6	36
S33KAYLW	12	6	36
S33KAWHT	12	6	36
S33LTBLK	12	6	36
S33LTBLU	12	6	36
S33LTGRN	12	6	36
S33LTORJ	12	6	36
S33LTPRP	12	6	36
S33LTRED	12	6	36
S33LTTEAL	12	6	36
S33LTYLW	12	6	36
S33LTWHT	12	6	36
S33ORJ	12	6	36
S33PRP	12	6	36
S33RED	12	6	36
S33TEAL	12	6	36
S33YLW	12	6	36
S33WHT	12	6	36
S101	21	1	6
S125	21	6	24
S140	21	—	1
S140LJA	21	—	1
S140LPL	21	—	1
S141	21	—	1

Product Number	Page Number	Shelf Pack Quantity	Master Carton Quantity
S142	21	1	1
S143	22	—	100
S143DE	22	—	100
S143ES	22	—	100
S143FR	22	—	100
S143JA	22	—	100
S143NL	22	—	100
S143ZH	22	—	100
S297	29	—	10
S297LES	29	—	10
S297LFR	29	—	10
S297LENUK	29	—	10
S430	22	6	72
S600	24	1	1
S600ALTAGLZ1	24	1	1
S600TAGLZ1	24	1	1
S600 Series Parts	24	—	—
S601	24	1	1
S601ALTAGLZ1	24	1	1
S601TAGLZ1	24	1	1
S602	24	1	1
S602ALTAGLZ1	24	1	1
S602TAGLZ1	24	1	1
S806	22	—	6
S806CBL3	22	—	6
S806CBL15	22	—	6
S806CBL Series Parts	22	—	6
S806D	31	—	6
S856	22	—	6
S856 Service Parts	22	—	—
S866	22	—	6
S866 Service Parts	22	—	—
S1010	26	1	1
S1010E410	26	1	1
S1010DELECKIT	31	—	4
S1010DGCKIT	31	—	4
S1017	26	1	1
S1023	26	1	1
S1105BLK	16	6	24
S1105BLU	16	6	24
S1105BRN	16	6	24
S1105CLR	16	6	24
S1105GRN	16	6	24
S1105KABLK	16	6	24
S1105KABLU	16	6	24
S1105KABRN	16	6	24
S1105KACL	16	6	24
S1105KAGRN	16	6	24

SPEED INDEX

Product Number	Page Number	Shelf Pack Quantity	Master Carton Quantity
S1105KAMK Series	16	6	24
S1105KAORJ	16	6	24
S1105KAPRP	16	6	24
S1105KARED	16	6	24
S1105KAYLW	16	6	24
S1105MK Series	16	6	24
S1105ORJ	16	6	24
S1105PRP	16	6	24
S1105RED	16	6	24
S1105YLW	16	6	24
S1106BLK	16	6	24
S1106BLU	16	6	24
S1106BRN	16	6	24
S1106CLR	16	6	24
S1106GRN	16	6	24
S1106KABLK	16	6	24
S1106KABLU	16	6	24
S1106KABRN	16	6	24
S1106KACL	16	6	24
S1106KAGRN	16	6	24
S1106KAMK Series	16	6	24
S1106KAORJ	16	6	24
S1106KAPRP	16	6	24
S1106KARED	16	6	24
S1106KAYLW	16	6	24
S1106MK Series	16	6	24
S1106ORJ	16	6	24
S1106PRP	16	6	24
S1106RED	16	6	24
S1106YLW	16	6	24
S1107BLK	16	6	24
S1107BLU	16	6	24
S1107BRN	16	6	24
S1107CLR	16	6	24
S1107GRN	16	6	24
S1107KABLK	16	6	24
S1107KABLU	16	6	24
S1107KABRN	16	6	24
S1107KACL	16	6	24
S1107KAGRN	16	6	24
S1107KAMK Series	16	6	24
S1107KAORJ	16	6	24
S1107KAPRP	16	6	24
S1107KARED	16	6	24
S1107KAYLW	16	6	24
S1107MK Series	16	6	24
S1107ORJ	16	6	24
S1107PRP	16	6	24

Product Number	Page Number	Shelf Pack Quantity	Master Carton Quantity
S1107RED	16	6	24
S1107YLW	16	6	24
S1506	28	1	1
S1518	28	1	1
S1700	37	1	1
S1705P410	37	1	1
S1720E410	37	1	1
S1745E410	37	1	1
S1800	27/28	1	1
S1850	27	1	1
S1850ES	27	1	1
S1850FRC	27	1	1
S1850E410	27	1	1
S1850E410ES	27	1	1
S1850E410FRC	27	1	1
S1850E1106	27	1	1
S1850E1106ES	27	1	1
S1850E1106FRC	27	1	1
S1850V410ES	27	1	1
S1850V410FRC	27	1	1
S1850V1106ES	27	1	1
S1850V1106FRC	27	1	1
S1900	27	1	1
S1900ES	27	1	1
S1900FRC	27	1	1
S1900VE410	27	1	1
S1900VE410ES	27	1	1
S1900VE410FRC	27	1	1
S1900VE1106ES	27	1	1
S1900VE1106FRC	27	1	1
S2005	25	1	1
S2151	26	6	24
S2152AST	26	—	24
S2153	26	6	24
S2154AST	26	—	24
S2390	25	1	1
S2391	25	1	1
S2392	25	1	1
S2393	25	1	1
S2394	25	12	144
S2394D	31	—	6
S3068	23	1	6
S3081	23	1	6
S3081D	31	—	6
S3476	23	1	24
S3477	23	1	24
S3500	24	—	1
S3500ALTAGLZ1	24	—	1

SPEED INDEX

Product Number	Page Number	Shelf Pack Quantity	Master Carton Quantity
S3500TAGLZ1	24	—	1
S3501	24	—	1
S3501 Tags	24	—	—
S3502	24	—	1
S3502ALTAGLZ1	24	—	1
S3502TAGLZ1	24	—	1
S3502 Key Cup & Tags	24	—	—
S3503	24	—	12
S3650	24	—	1
S3650ALTAGLZ1	24	—	1
S3821	25		36
S3822	25		36
S3823	25		36
S3900	23	1	6
S3910	23	1	6
S3920	23	1	24
S3921	23	1	6
S3922	23	1	6
S3923	23	1	6
S3924	23	1	6
S4002	29	—	1
S4002MT	29	—	1
S4046	29	—	1
S4050	29	—	1
S4058	29	—	1
S4060	29	—	1
S4800LES	29	—	6
S4801	29	—	6
S4802LEN	29	—	6
S4810	29	—	12
S4810LES	29	—	12
S4810LFR	29	—	12
S4810LPT	29	—	12
S4810LENUK	29	—	12
S6835BLK	—	repl. by S1105BLK	
S6835BLU	—	repl. by S1105BLU	

Product Number	Page Number	Shelf Pack Quantity	Master Carton Quantity
S6835GRN	—	repl. by S1105GRN	
S6835KABLK	—	repl. by S1105KABLK	
S6835KABLU	—	repl. by S1105KABLU	
S6835KAGRN	—	repl. by S1105KAGRN	
S6835KALFBLK	—	repl. by S1106KABLK	
S6835KALFBLU	—	repl. by S1106KABLU	
S6835KALFGRN	—	repl. by S1106KAGRN	
S6835KALFORJ	—	repl. by S1106KAORJ	
S6835KALFRED	—	repl. by S1106KARED	
S6835KALFYLW	—	repl. by S1106KAYLW	
S6835KALTBLK	—	repl. by S1107KABLK	
S6835KALTBLU	—	repl. by S1107KABLU	
S6835KALTGRN	—	repl. by S1107KAGRN	
S6835KALTORJ	—	repl. by S1107KAORJ	
S6835KALTRED	—	repl. by S1107KARED	
S6835KALTYLW	—	repl. by S1107KAYLW	
S6835KAMK Series	—	repl. by S1105KAMK Series	
S6835KAORJ	—	repl. by S1105KAORJ	
S6835KARED	—	repl. by S1105KARED	
S6835KAYLW	—	repl. by S1105KAYLW	
S6835LFBK	—	repl. by S1106BLK	
S6835LFBLU	—	repl. by S1106BLU	
S6835LFGRN	—	repl. by S1106GRN	
S6835LFORJ	—	repl. by S1106ORJ	
S6835LFRED	—	repl. by S1106RED	
S6835LFYLW	—	repl. by S1106YLW	
S6835LTBLK	—	repl. by S1107BLK	
S6835LTBLU	—	repl. by S1107BLU	
S6835LTGRN	—	repl. by S1107GRN	
S6835LTORJ	—	repl. by S1107ORJ	
S6835LTRED	—	repl. by S1107RED	
S6835LTYLW	—	repl. by S1107YLW	
S6835MK Series	—	repl. by S1105MK Series	
S6835ORJ	—	repl. by S1105ORJ	
S6835RED	—	repl. by S1105RED	
S6835YLW	—	repl. by S1105YLW	

Master Lock Safety Lockout Padlocks — Lightweight Engineered Zenex™ Thermoplastic



S31RED
Stainless Shackle.
Key Retaining



S32GRN
Plastic Shackle.
Non-Key Retaining



S33YLW
Stainless Shackle.
Non-Key Retaining



S31REDCOV

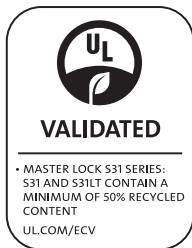

Example	S31 RED
----------------	---------

Base Model	Description
S31	Key Retaining. 6-pin Reserved for Safety W401 cylinder. Durable, chemical resistant plastic. 1-3/8in (35mm) wide body. 3/16in (5mm) diameter stainless steel shackle. 1-1/2in (38mm) high clearance. Includes labels in English, Spanish, and French.
S32	Non-Key Retaining. 6-pin Reserved for Safety W401 cylinder. Durable, chemical resistant plastic. 1-3/8in (35mm) wide body. 3/16in (5mm) diameter plastic shackle. 1-1/2in (38mm) high clearance. Includes labels in English, Spanish and French.
S33	Non-Key Retaining. 6-pin Reserved for Safety W401 cylinder. Durable, chemical resistant engineered plastic. 1-3/8in (35mm) wide body. 3/16in (5mm) diameter stainless steel shackle. 1-1/2in (38mm) high clearance. Includes labels in English, Spanish, and French.

Keying	Standard: Keyed Different MK & KAMK Standard: 6-pin Reserved for Safety W417 cylinder
---------------	--

KA	Keyed Alike
MK	Master Keyed
KAMK	Keyed Alike; Master Keyed

Shackle	Standard: 1-1/2in (38mm) high
LT	3in (76mm) high stainless steel shackle (S31 & S33 Option Only)

Body Color	Required Choice
RED – Red; YLW – Yellow; GRN – Green; BLU** – Blue; ORJ – Orange; BLK** – Black; TEAL – Teal; PRP – Purple; WHT – White	

Extreme Environment Padlock Cover	
COV	Seals at shackle and keyway to help keep out dust and grime in extreme environments

Custom Marking	
LZ1	Laser engraved in 1 area
LZ2	Laser engraved in 2 areas
LZ3	Laser engraved in 3 areas
LZ4	Laser engraved in 4 areas

Number of Keys	– FOR KEYED DIFFERENT PADLOCKS Standard: 1 key per lock
2KEY	2 keys per lock
3KEY	3 keys per lock
4KEY	4 keys per lock

Number of Keys	– FOR KEYED ALIKE SETS OF PADLOCKS Standard: 1 key per lock
1KS	1 key per set of same keyed alike number
2KS	2 keys per set of same keyed alike number
3KS	3 keys per set of same keyed alike number
4KS	4 keys per set of same keyed alike number

Add'l Languages	
Use appropriate code: LFR – Euro French; LRU – Russian	

NOTE: *W400 cylinder is available which offers over 95,000 key codes. Please contact Master Lock for additional information.
**Laser engraving on blue or black Thermoplastic padlocks may be difficult to read in low light conditions.

Master Lock Safety Lockout Padlocks — Keyed-Alike Sets

Popular quantities of safety padlocks are packed in keyed alike sets, so all the locks in one set open with the supplied key. No duplicate key is offered within a master carton. Each keyed alike set includes 2 keys.

Example S31KAS12 RED



S31RED



S33YLW

Model	Set Qty Description	Unit of Measure	Order Quantity	Shelf Pack	Master Carton
S31KAS	Key Retaining. Safety padlock must be locked in order to remove key. Durable, chemical resistant engineered plastic. 1-3/8in (35mm) wide body. 3/16in (5mm) diameter stainless steel shackle. 1-1/2in (38mm) high clearance. Includes labels in English, Spanish, and French. Other languages available.				
S31KAS3	3 Locks Keyed Alike	Each	1	1	8
S31KAS6	6 Locks Keyed Alike	Each	1	1	6
S31KAS12	12 Locks Keyed Alike	Each	1	1	1
S33KAS	Non-Key Retaining. Durable, chemical resistant engineered plastic. 1-3/8in (35mm) wide body. 3/16in (5mm) diameter stainless steel shackle. 1-1/2in (38mm) high clearance. Includes labels in English, Spanish, and French. Other languages available.				
S33KAS3	3 Locks Keyed Alike	Each	1	1	8
S33KAS6	6 Locks Keyed Alike	Each	1	1	6
S33KAS12	12 Locks Keyed Alike	Each	1	1	1

Body Color Required Choice
RED – Red; **YLW** – Yellow; **GRN** – Green; **BLU** – Blue; **ORJ** – Orange; **BLK** – Black

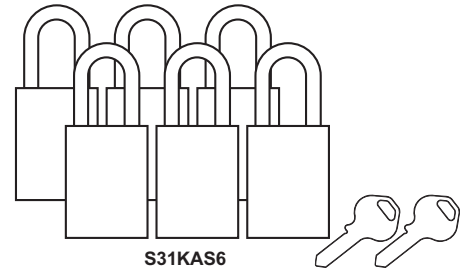
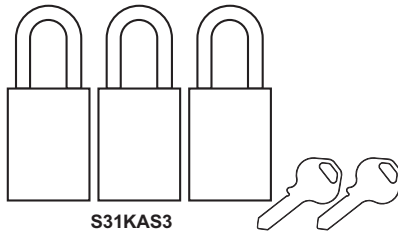

NOTE: Key numbers for Keyed Alike Sets can be added to an existing End User Chart after receipt of the padlock set. Fill out the Key Charting Registration Form with the key number(s) and End User Registration ID. Fax the form to the provided number. Master Lock will add to your existing chart.

Master Lock Safety Lockout Padlocks — Lightweight Engineered Zenex™ Thermoplastic



410RED

406RED

411GRN



410REDCOV

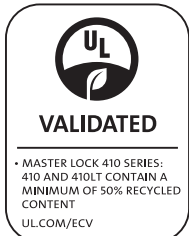

Example	410 RED
----------------	---------

Base Model	Description
410	Durable, chemical resistant plastic. Short body, 1-1/2in (38mm) wide body. 1/4in (6mm) dia shackle. 1-1/2in (38mm) high clearance. Includes labels in English, Spanish, and French. Key Retaining. 6-pin Reserved for Safety W401 cylinder.
411	Durable, chemical resistant plastic. Tall body, 1-1/2in (38mm) wide body . 1/4in (6mm) dia shackle. 1-1/2in (38mm) high clearance. Includes bilingual labels in English/Spanish and English/French. Key Retaining. 6-pin Reserved for Safety W401 cylinder.
406	Durable, chemical resistant plastic. Plastic shackle. Short body, 1-1/2in (38mm) wide body. 1/4in (6mm) dia shackle. 1-1/2in (38mm) high clearance. Includes labels in English, Spanish and French. Key Retaining. 6-pin Reserved for Safety W401 cylinder.

Keying	Standard: Keyed Different MK & KAMK Standard: 6-pin Reserved for Safety W417 cylinder
KA	Keyed Alike
MK	Master Keyed
KAMK	Keyed Alike; Master Keyed

Shackle	Standard: 1-1/2in (38mm) high
LT	3in (76mm) high steel shackle (410 & 411 Option Only)

Body Color	Required Choice
RED – Red; YLW – Yellow; GRN – Green; BLU** – Blue; ORJ – Orange; BLK** – Black; TEAL – Teal; PRP – Purple	

Extreme Environment Padlock Cover	
COV	Seals at shackle and keyway to help keep out dust and grime in extreme environments

Custom Marking	
LZ1	Laser engraved in 1 area
LZ2	Laser engraved in 2 areas
LZ3	Laser engraved in 3 areas
LZ4	Laser engraved in 4 areas

Number of Keys	– FOR KEYED DIFFERENT PADLOCKS Standard: 1 key per lock
2KEY	2 keys per lock
3KEY	3 keys per lock
4KEY	4 keys per lock

Number of Keys	– FOR KEYED ALIKE SETS OF PADLOCKS Standard: 1 key per lock
1KS	1 key per set of same keyed alike number
2KS	2 keys per set of same keyed alike number
3KS	3 keys per set of same keyed alike number
4KS	4 keys per set of same keyed alike number

Add'l Languages	
Use appropriate code: LFR – Euro French; LRU – Russian	

NOTE: *W400 cylinder is available which offers over 95,000 key codes. Please contact Master Lock for additional information.
**Laser engraving on blue or black Thermoplastic padlocks may be difficult to read in low light conditions.

Master Lock Safety Lockout Padlocks — Keyed-Alike Sets

Popular quantities of safety padlocks are packed in keyed alike sets, so all the locks in one set open with the supplied key. No duplicate key is offered within a master carton. Each keyed alike set includes 2 keys.

Example 410KAS12 RED



406RED



410RED



411GRN

Model	Set Qty Description	Unit of Measure	Order Quantity	Shelf Pack	Master Carton
406	Zenex™ Thermoplastic Safety Padlock. Plastic shackle. Short body, 1-1/2in (38mm) wide body. 1/4in (6mm) dia shackle. 1-1/2in (38mm) high clearance. Includes labels in English, Spanish and French. Key Retaining.				
406KAS3	3 Locks Keyed Alike	Each	1	1	8
406KAS6	6 Locks Keyed Alike	Each	1	1	6
406KAS12	12 Locks Keyed Alike	Each	1	1	1
410	Zenex™ Thermoplastic Safety Padlock. Short body, 1-1/2in (38mm) wide body. 1/4in (6mm) dia shackle. 1-1/2in (38mm) high clearance. Includes labels in English, Spanish, and French. Key Retaining.				
410KAS3	3 Locks Keyed Alike	Each	1	1	8
410KAS6	6 Locks Keyed Alike	Each	1	1	6
410KAS12	12 Locks Keyed Alike	Each	1	1	1
411	Zenex™ Thermoplastic Safety Padlock. Tall body, 1-1/2in (38mm) wide body. 1/4in (6mm) dia shackle. 1-1/2in (38mm) high clearance. Includes bilingual labels in English/Spanish and English/French. Key Retaining.				
411KAS3	3 Locks Keyed Alike	Each	1	1	8
411KAS6	6 Locks Keyed Alike	Each	1	1	6
411KAS12	12 Locks Keyed Alike	Each	1	1	1

Body Color Required Choice

RED – Red; YLW – Yellow; GRN – Green; BLU – Blue; ORJ – Orange; BLK – Black

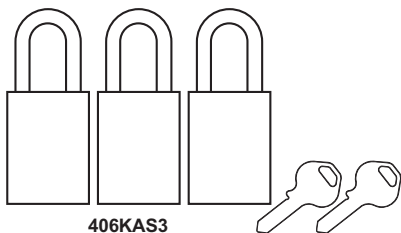

406KAS3

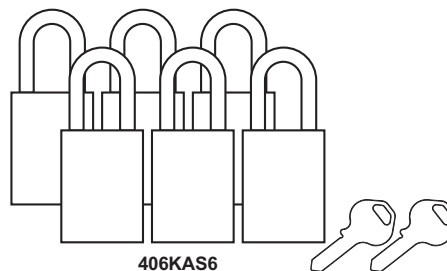

406KAS6

NOTE: Key numbers for Keyed Alike Sets can be added to an existing End User Chart after receipt of the padlock set. Fill out the Key Charting Registration Form with the key number(s) and End User Registration ID. Fax the form to the provided number. Master Lock will add to your existing chart.

American Lock Safety Lockout Padlocks — Anodized Aluminum



S1105RED,
A1105RED
& A1165RED



S1106RED,
A1106RED
& A1166RED



S1107RED,
A1107RED
A1167RED



S1106REDCOV
& A1106REDCOV

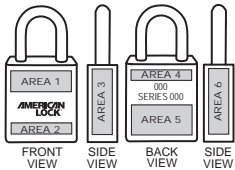

FRONT VIEW SIDE VIEW BACK VIEW SIDE VIEW



Example	S1105 KA YLW COV LZ1
Base Model*	Description
S1105	Aluminum Safety Specific Padlock, 6-pin Reserved for Safety, W401 cylinder. 1-1/2in (38mm) wide body. 1/4in (6mm) dia shackle. 1in (25mm) high clearance.
S1106	Aluminum Safety Specific Padlock, 6-pin Reserved for Safety, W401 cylinder. 1-1/2in (38mm) wide body. 1/4in (6mm) dia shackle. 1-1/2in (38mm) high clearance.
S1107	Aluminum Safety Specific Padlock, 6-pin Reserved for Safety, W401 cylinder. 1-1/2in (38mm) wide body. 1/4in (6mm) dia shackle. 3in (76mm) high clearance.
A1105	Aluminum Safety Padlock. 5-pin locking mechanism. APTC12 cylinder. 1-1/2in (38mm) wide body. 1/4in (6mm) dia shackle. 1in (25mm) high clearance.
A1106	Aluminum Safety Padlock. 5-pin locking mechanism. APTC12 cylinder. 1-1/2in (38mm) wide body. 1/4in (6mm) dia shackle. 1-1/2in (38mm) high clearance.
A1107	Aluminum Safety Padlock. 5-pin locking mechanism. APTC12 cylinder. 1-1/2in (38mm) wide body. 1/4in (6mm) dia shackle. 3in (76mm) high clearance.
*A1165, A1166 and A1167 models still available with 6-pin APTC14 cylinder. Optional MK and KAMK Reserved for Safety W417 cylinder available.	
Keying	Standard: Keyed Different
KA	Keyed Alike
MK	Master Keyed (Must add cylinder code if selecting W417 for A1165, A1166, A1167.)
KAMK	Keyed Alike; Master Keyed (Must add cylinder code if selecting W417 for A1165, A1166, A1167.)
Chain	
CN	Chain attached to shackle 9in (23cm) long, Zinc plated steel chain with chain holder
Function	Standard: Non-Key Retaining – Key can be removed even if shackle is unlocked for A1100 models. Key Retaining – Key can only be removed if padlock shackle is in locked position for S1100 models.
NR	Key Retaining. Key can only be removed if padlock shackle is in locked position.
RMVK	Non-key retaining. Key can be removed even if shackle is unlocked.
Cylinder*	Standard: 6-pin W401 cylinder: S1105, S1106 & S1107 Series (Over 40,000 unique key numbers) 5-pin APTC12 cylinder: A1105, A1106 & A1107 Series (Over 10,000 unique key numbers) 6-pin APTC14 cylinder: A1165, A1166 & A1167 Series (Over 40,000 unique key numbers)
W417	Master Keyed. 6 Pin. Reserved for Safety Lockout cylinder (S1105MK, S1106MK, S1107MK, A1165MK, A1165KAMK, A1166MK, A1166KAMK, A1167MK, A1167KAMK Option only)
Body Color	Required Choice
RED – Red; YLW – Yellow; GRN – Green; BLU – Blue; ORJ – Orange; BLK – Black; CLR – Clear; BRN – Brown; PRP – Purple	
Extreme Environment Padlock Cover	
COV	Seals at shackle and keyway to help keep out dust and grime in extreme environments
Custom Marking	
LZ1	Laser engraved in 1 area
LZ2	Laser engraved in 2 areas
LZ3	Laser engraved in 3 areas
LZ4	Laser engraved in 4 areas
LZ5	Laser engraved in 5 areas
LZ6	Laser engraved in 6 areas
Number of Keys	Standard: 1 key per lock for S1100 series; 2 keys per lock for A1100 series.
1KEY	1 key per lock
2KEY	2 keys per lock
3KEY	3 keys per lock
4KEY	4 keys per lock
NOKEY	0 keys per lock

*Cylinder upcharge does not apply to S1100 series.

American Lock Safety Lockout Padlocks — Keyed-Alike Sets

Popular quantities of safety padlocks are packed in keyed alike sets, so all the locks in one set open with the supplied key. No duplicate key is offered within a master carton. Each keyed alike set includes 2 keys.



A1105RED



A1106RED

Example	A1105KAS12 RED
----------------	----------------

Model	Set Qty Description	Unit of Measure	Order Quantity	Shelf Pack	Master Carton
A1105	Aluminum Safety Padlock. 5-Pin locking mechanism. 1-1/2in (38mm) wide body, 1/4in (6mm) dia shackle. 1in (25mm) high clearance.				
A1105KAS3	3 Locks Keyed Alike	Each	1	1	8
A1105KAS6	6 Locks Keyed Alike	Each	1	1	4
A1105KAS12	12 Locks Keyed Alike	Each	1	1	1
A1106	Aluminum Safety Padlock. 5-Pin locking mechanism. 1-1/2in (38mm) wide body, 1/4in (6mm) dia shackle. 1-1/2in (38mm) high clearance.				
A1106KAS3	3 Locks Keyed Alike	Each	1	1	8
A1106KAS6	6 Locks Keyed Alike	Each	1	1	4
A1106KAS12	12 Locks Keyed Alike	Each	1	1	1

Body Color	Required Choice
RED – Red; YLW – Yellow; GRN – Green; BLU – Blue	

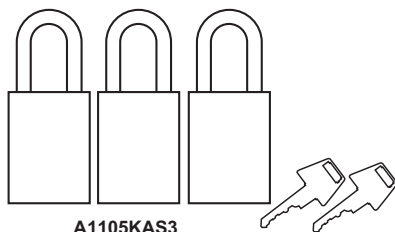

A1105KAS3

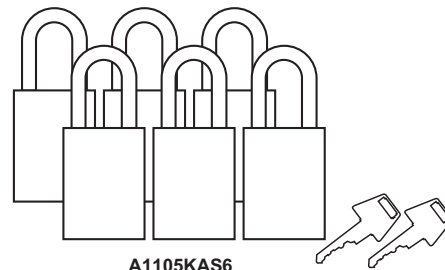

A1105KAS6

NOTE: Key numbers for Keyed Alike Sets can be added to an existing End User Chart after receipt of the padlock set. Fill out the Key Charting Registration Form with the key number(s) and End User Registration ID. Fax the form to the provided number. Master Lock will add to your existing chart.

Master Lock Safety Lockout Padlocks — Laminated Steel with Colored Bumper



3RED

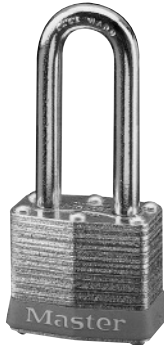

3LFRED



3LHRED

Example	3 RED 1KEY
----------------	------------

Base Model	Description
3	Laminated Steel Safety Padlock with bumper, 1-9/16in (40mm) wide body. 9/32in (7mm) dia shackle. 9/16in (16mm) high clearance. 4 Pin cylinder.

Keying	Standard: Keyed Different
KA	Keyed Alike
MK	Master Keyed
KAMK	Keyed Alike; Master Keyed

Shackle	Standard: 3/4in (19mm) high
LF	1-1/2in (38mm) high
LH	2in (51mm) high

Chain	
CN	Chain attached to shackle 9in (23cm) long, Zinc plated steel chain with chain holder

Bumper Color	Required Choice
RED – Red; YLW – Yellow; GRN – Green; BLU – Blue; WHT – White; BLK – Black	

Number of Keys	– FOR KEYED DIFFERENT PADLOCKS	Standard: 2 keys per lock
1KEY	1 key per lock	
3KEY	3 keys per lock	
4KEY	4 keys per lock	
NOKEY	0 keys per lock	

Number of Keys	– FOR KEYED ALIKE SETS OF PADLOCKS	Standard: 2 keys per individual lock
1KS	1 key per set of same keyed alike number	
2KS	2 keys per set of same keyed alike number	
3KS	3 keys per set of same keyed alike number	
4KS	4 keys per set of same keyed alike number	

Master Lock Safety Lockout Padlocks — Keyed-Alike Sets

Popular quantities of safety padlocks are packed in keyed alike sets, so all the locks in one set open with the supplied key. No duplicate key is offered within a master carton. Each keyed alike set includes 2 keys.



3RED

Example	3KAS12 RED
----------------	------------

Model	Set Qty Description	Unit of Measure	Order Quantity	Shelf Pack	Master Carton
3	Laminated Steel Safety Padlock with bumper, 1-9/16in (40mm) wide body. 9/32in (7mm) dia shackle. 9/16in (16mm) high clearance. 4 Pin cylinder.				
3KAS3	3 Locks Keyed Alike	Each	1	1	8
3KAS6	6 Locks Keyed Alike	Each	1	1	4
3KAS12	12 Locks Keyed Alike	Each	1	1	1

Bumper Color	Required Choice
RED – Red; YLW – Yellow; GRN – Green; BLU – Blue; WHT – White; BLK – Black	

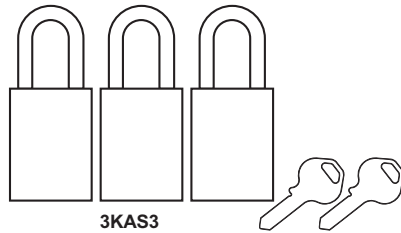

3KAS3

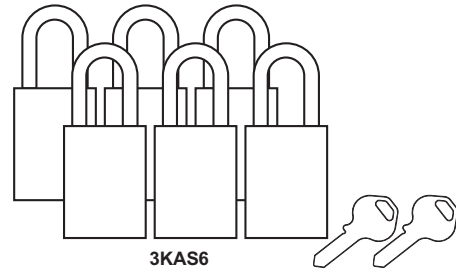

3KAS6

NOTE: Key numbers for Keyed Alike Sets can be added to an existing End User Chart after receipt of the padlock set. Fill out the Key Charting Registration Form with the key number(s) and End User Registration ID. Fax the form to the provided number. Master Lock will add to your existing chart.

American Lock Safety Lockout Padlocks — Interchangeable Core — Anodized Aluminum



A3105RED



A3106RED



A3107RED

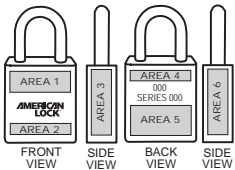

Example	A3105 CN CY 626D RED
Base Model	Description
A3105	Aluminum IC Safety Padlock. 1-1/2in (38mm) wide body. 1/4in (6mm) dia shackle. 1in (25mm) high clearance.
A3106	Aluminum IC Safety Padlock. 1-1/2in (38mm) wide body. 1/4in (6mm) dia shackle. 1-1/2in (38mm) high clearance.
A3107	Aluminum IC Safety Padlock. 1-1/2in (38mm) wide body. 1/4in (6mm) dia shackle. 3in (76mm) high clearance.
Chain	
CN	Chain attached to shackle 9in (23cm) long, Zinc plated steel chain with chain holder
Function	Standard: Non-Key Retaining – Key can be removed even if shackle is unlocked
NR	Key Retaining. Key can only be removed if padlock shackle is in locked position.
Cores	
W0	Lock without cylinder
CY	Master Lock Keyway
Number of Pins & Core Finish	Standard: Keyed Different
626D	6 Pins & Satin Chrome Finish
Keying	Standard: Keyed Different
UN	Uncombined. No (0) keys included.
KA	Keyed Alike
MK	Master Keyed
KAMK	Keyed Alike; Master Keyed
Body Color	Required Choice
RED – Red; YLW – Yellow; GRN – Green; BLU – Blue; ORJ – Orange; BLK – Black; CLR – Clear Coat; BRN – Brown; PRP – Purple	
Custom Marking	
LZ1	Laser engraved in 1 area
LZ2	Laser engraved in 2 areas
LZ3	Laser engraved in 3 areas
LZ4	Laser engraved in 4 areas
LZ5	Laser engraved in 5 areas
LZ6	Laser engraved in 6 areas
Number of Keys	Standard: 2 keys per lock
1KEY	1 key per lock
3KEY	3 keys per lock
4KEY	4 keys per lock
NOKEY	0 keys per lock

Registered trademarks are the property of their respective owners.



Specialty Padlocks (Commercial Boxed Products)

Product Number	Description
Circuit Breaker Switch Padlock	
7C5RED	Compact Circuit Breaker Padlock with 5in (127mm) Flexible Steel Cable
Breakaway Shackle Padlock	
500KABRK	Laminated Steel Padlock with Breakaway shackle. Warded keying.



Extreme Environment Padlock Covers (Commercial Bagged Products)

Product Number	Description
S30COVERS	Safety padlock cover for S31, S32 and S33 padlocks – seals at shackle and keyway to help keep out dust and grime in extreme environments, Bag of 72 (Master Carton 1 bag)
S101	Safety padlock cover for S1100/ A1100 Series - seals at shackle and keyway to help keep out dust and grime in extreme environments, Bag of 12 (Master Carton 6 bags)



Padlock Accessories (Commercial Boxed Products, Master Carton 1)

Product Number	Description
71CS	9in (23cm) long light-weight zinc plated steel chain with mounting bracket. Add 71SC8 or 71SC9 collar to attach to Safety Padlock shackle. (bag contains 12 chains)
71SC7	Shackle Mounting Collar for 7/32in (5.6mm) diameter shackles on #3. Includes rivet. (bag contains 12 collars)
71SC8	Shackle Mounting Collar for 1/4in (6mm) diameter shackles on 410, 411, 6835, 6836. Includes rivet. (bag contains 12 collars)
71TAG	1/2in (13mm) x 1-3/4in (44mm) brass tag with ring for attaching to shackle collar. (each bag contains 12 collars)
S125	Safety Padlock Caddy. Helps ensure all lockout points on designated machinery are addressed. Keep safety padlocks near the designated locked out machinery.



Padlock Labels (Commercial Boxed Products)

Product Number	Description
Write-On Labels	
S140	North American English, Spanish & French Padlock Labels for 410, 406, S31 & S33 padlocks, 1in (25mm) x 1-3/16in (30mm) (150 labels total, 50/each language) (Master Carton 1)
S141	North American English/Spanish, & English/French Padlock Labels for 411 padlocks, 1in (25mm) x 3-3/8in (86mm) (100 labels total, 50/each language) (Master Carton 1)
461	Lock Labels for 3, 5in (127mm) w x 1in (25mm) (50 pack) (Master Carton 6)
Photo ID Write-On Labels (Master Carton 1)	
S142	Photo I.D. Labels for 410, 406, S31, and S33 padlocks. 1in (25mm) x 1-1/4in (32mm) (Each bag includes 6 labels)
0411-5705	Photo I.D. Labels for 411, 1in (25mm) w x 3-3/8in (86mm) (Each bag includes 6 labels)
6835-5700	Photo I.D. Labels 1-1/4in (32mm) w x 2-3/4in (70mm) (Each bag includes 6 labels)
6835-5701	Roll of 500 Photo I.D. Labels for 6835, 1-1/4in (32mm) w x 2-3/4in (70mm) (500 labels)
Multilingual Padlock Labels (Commercial Boxed and Bagged Products, Master Carton 1)	
S140LJA	Japanese Padlock Labels for 410 & 406 padlocks (50 label sets)
S140LPL	Polish Padlock Labels for 410 & 406 padlocks (50 label sets)

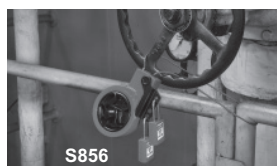

Lockout Hasps (Commercial Boxed and Bagged Products)	
Product Number	Description
ALO80	Safety Hasp, 1in (25mm) Diameter Steel Jaws with locking tabs, Red (Shelf Pack 12; Master Carton 72)
ALO802	Safety Hasp, 1.5in (38mm) Diameter Steel Jaws with locking tabs, Red (Shelf Pack 12; Master Carton 72)
416	Safety Hasp, Aluminum, 1in (25mm) Diameter Jaws, Red Handle (Shelf Pack 12; Master Carton 72)
417	Safety Hasp, Aluminum, 1-1/2in (38mm) Diameter Jaws, Red Handle (Shelf Pack 12; Master Carton 72)
418	Safety Hasp, Heavy Duty, 4 padlock capacity (Shelf Pack 12; Master Carton 72)
419	Safety Hasp, Heavy Duty, 8 padlock capacity (Shelf Pack 12; Master Carton 72)
420	Safety Hasp, 1in (25mm) Diameter Steel Jaws, Red (Shelf Pack 12; Master Carton 72)
421	Safety Hasp, 1-1/2in (38mm) Diameter Steel Jaws, Red (Shelf Pack 12; Master Carton 72)
427	Labeled Snap-On Hasp - Red (Shelf Pack 6; Master Carton 24)
428	Plastic non-conductive Red Hasp (Shelf Pack 12; Master Carton 72)
429	Safety Hasp, Dual Jaw, Aluminum 1in (25mm) and 1-1/2in (38mm) Jaws (Shelf Pack 12; Master Carton 72)
S430	Safety Hasp, Steel 1in (25mm) Jaw with 4mm diameter, Red, 2 padlock capacity (Shelf Pack 12; Master Carton 72)

Adjustable Cable Lockouts (Commercial Boxed and Bagged Products)	
Product Number	Description
S806	Adjustable Cable Lockout with 6ft (1.8m) x 5/32in (4mm) dia Steel Cable (Master Carton 6)
S806CBL3	Adjustable Cable Lockout with 3ft (.91m) x 5/32in (4mm) dia Steel Cable (Master Carton 6)
S806CBL15	Adjustable Cable Lockout with 15ft (4.6m) x 5/32in (4mm) dia Steel Cable (Master Carton 6)
S806CBLN	Adjustable Cable Lockout (N = 7ft (2.1m) through 50ft (15.2m), increments of 1ft (.3m) Ex. CBL7 - CBL50)

Retractable Cable Lockouts (Commercial Boxed and Bagged Products)	
Product Number	Description
S856	Retractable Cable Lockout with 9ft (2.74m) x 1/8in (3.3mm) dia. Steel Core, Red Cable (Master Carton 6)
S866	Retractable Cable Lockout with 9ft (2.74m) x 1/8in (3.3mm) dia. Nylon Core, Yellow Cable (Master Carton 6)
Replacement Parts	
PKGP52709	Replacement Cable Kit - Steel Core, Red Cable (Master Carton 12)
PKGP52711	Replacement Cable Kit - Nylon Core, Yellow Cable (Master Carton 12)
Danger Labels for S856/S866	
S143	Trilingual Danger Labels (English, French, Spanish) and Warning/Write-on Labels. Pack of 100 labels, 50 of each design. (Master Carton 100 packs)
S143FR	Danger Labels. French. Pack of 50 labels. (Master Carton 100 packs)
S143ZH	Danger Labels. Mandarin Chinese. Pack of 50 labels. (Master Carton 100 packs)
S143ES	Danger Labels. European Spanish. Pack of 50 labels. (Master Carton 100 packs)
S143JA	Danger Labels. Japanese. Pack of 50 labels. (Master Carton 100 packs)
S143DE	Danger Labels. German. Pack of 50 labels. (Master Carton 100 packs)
S143NL	Danger Labels. Flemish. Pack of 50 labels. (Master Carton 100 packs)



Valve Lockouts (Commercial Boxed and Bagged Products)

Product Number	Description
Ball Valve	
468L	Seal Tight™ Handle Off Ball Valve Lockout Device (Master Carton 6)
S3068	Seal Tight™ Handle On Ball Valve Lockout Device (Master Carton 6)
S3081	Adjustable Ball Valve Lockout Device (Master Carton 6)
S3476	1/4 Turn Ball Valve Lockout Device – fits valves between 1/4in (6.35mm) to 1in (25mm) dia (Master Carton 24)
S3477	1/4 Turn Ball Valve Lockout Device – fits valves between 1-1/4in (31mm) to 3in (76mm) dia (Master Carton 24)
Butterfly Valve	
S3920	Butterfly Valve Lockout Device (Master Carton 24)
S3921	Butterfly Valve Lockout Device with S806CBL3 Cable Lockout (Master Carton 6)
Gate Valve	
480	Gate Valve Lockout Device fits 1in (25mm) to 3in (76mm) dia. handles (Master Carton 6)
481	Gate Valve Lockout Device fits 2in (51mm) to 5in (12.7cm) dia. handles (Master Carton 6)
482	Gate Valve Lockout Device fits 4in (10.2cm) to 6.5in (16.5cm) dia. handles (Master Carton 6)
483	Gate Valve Lockout Device fits 6in (15.2cm) to 10in (25.4cm) dia. handles (Master Carton 6)
484	Gate Valve Lockout Device fits 8in (13.2cm) to 13in (33cm) dia. handles (Master Carton 6)
485	Gate Valve Lockout Device Nested Assortment (all 5 sizes) (Master Carton 1)
Pressurized Gas Valve	
S3910	Valve Lockout Device Fits Up to 3in (76mm) Valves. Fits Traditional Valves With or Without Guarding, Thicker Neck Valves (Master Carton 6)

Blind Lockouts (Commercial Boxed and Bagged Products)

Product Number	Description
S3922	Blind/Flange Lockout Device, Nut Diameter 3/4in – 1-1/8in (19mm – 28.7mm) (Master Carton 6)
S3923	Blind/Flange Lockout Device, Nut Diameter 1-5/16in – 1-7/8in (33.3mm – 28.7mm) (Master Carton 6)
S3924	Blind/Flange Lockout Device, Nut Diameter 2in – 2-3/4in (52.3mm – 69.9mm) (Master Carton 6)



Pneumatic Lockout (Commercial Boxed and Bagged Products)

Product Number	Description
S3900	Stainless Steel Pneumatic Lockout (Master Carton 1) , accommodates 1/4in, 5/16in, 3/8in, 7/16in, 1/2in, 9/16in, 5/8in, 13/16in connections



Stainless Steel Group Lock Boxes (Commercial Boxed Products)

Product Number	Description
S3650 Group Lock Box with Wall Mounting Bracket	
S3650	Group Lock Box with Wall Mounting Bracket (Master Carton 1)
With Laser Engraved Tag	
S3650ALTAGLZ1	Black Anodized Aluminum Tag, Engraved, on S3650 Group Lock Box (Master Carton 1)
Replacement Parts	
PKGP57337	Mounting Bracket for S3650 Group Lock Box
PKGP58381	Rewritable Tag for S3650 Group Lock Box and Bracket (Bag of 20)
S3500 Series: Group Lockout & Permit Control Station	
S3500	Permit Control Station, includes S3501 and S3502 (Master Carton 1)
S3501	Permit Display Case (Master Carton 1)
S3502	Wall Mount Group Lock Box (Master Carton 1)
With Laser Engraved Tag	
S3500ALTAGLZ1	Black Anodized Aluminum Tag, Engraved, on S3500 Permit Control Station (Master Carton 1)
S3500TAGLZ1	Brass Tag, Engraved, on S3500 Permit Control Station (Master Carton 1)
S3502ALTAGLZ1	Black Anodized Aluminum Tag, Engraved, on S3502 Permit Control Station (Master Carton 1)
S3502TAGLZ1	Brass Tag, Engraved, on S3502 Permit Control Station (Master Carton 1)
Replacement Parts	
S3503	Lock Caddy for S3500/S3502 (Box of 12)
PKGP44055	Rewritable Tags for S3500/S3501 (Bag of 20)
PKGP50837	Key Cup for S3500/S3502 (Box of 5)
S600 Series: Portable Group Lock Boxes with Window	
S600	Group Lock Box with Window (Master Carton 1)
S601	Group Lock Box with Key and Compartment Windows (Master Carton 1)
S602	Large Group Lock Box with Window and Rewritable Label (Master Carton 1)
With Laser Engraved Tag	
S600ALTAGLZ1	Black Anodized Aluminum Tag, Engraved, on S600 Lock Box with Window (Master Carton 1)
S600TAGLZ1	Brass Tag, Engraved, on S600 Lock Box with Window (Master Carton 1)
S601ALTAGLZ1	Black Anodized Aluminum Tag, Engraved, on S601 Lock Box with Window (Master Carton 1)
S601TAGLZ1	Brass Tag, Engraved, on S601 Lock Box with Window (Master Carton 1)
S602ALTAGLZ1	Black Anodized Aluminum Tag, Engraved, on S602 Large Lock Box with Window (Master Carton 1)
S602TAGLZ1	Brass Tag, Engraved, on S602 Large Lock Box with Window (Master Carton 1)
Replacement Parts	
PKGP43150	Rewritable Tag for S600/S601/S602 (Bag of 20)
PKGP43216	Key Holder for S600/S601 (Box of 5)
PKGP43217	Key Cup for S602 (Box of 5)

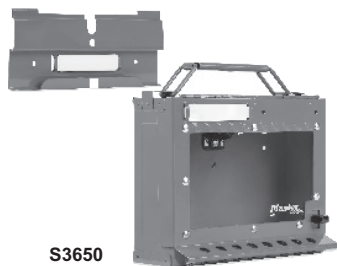



498A



503RED

Steel Group Lock Boxes (Commercial Boxed Products)

Product Number	Description
Portable	
498A	Latch Tight™ Portable Group Lock Box (Master Carton 1)
With Laser Engraved Tag	
498AALTAGLZ1	Black Anodized Aluminum Tag, Engraved, on 498A Portable Lock Box (Master Carton 1)
498ATAGLZ1	Brass Tag, Engraved, on 498A Portable Lock Box (Master Carton 1)
Dual Application	
503RED	Latch Tight™ Dual Application Group Lock Box - Red (Master Carton 1)
503YLW	Latch Tight™ Dual Application Group Lock Box -Yellow (Master Carton 1)



S3821



S3823



S3822



491B



493B



S2392



S2394

Electrical Lockouts (Commercial and Retail Bagged Products)

Product Number	Description
Circuit Breaker Devices	
Grip Tight™ Plus	
S3821	Grip Tight™ Plus Lockout Device for Miniature Circuit Breakers (120/240 V) (Master Carton 36)
S3822	Grip Tight™ Plus Lockout Device for Molded Case Circuit Breakers (480/600 V) (Master Carton 36)
S3823	Grip Tight™ Plus Lockout Device for Oversized Handle Circuit Breakers (480/600 V) (Master Carton 36)
Grip Tight™	
491B	Grip Tight™ Lockout Device for wide or tall breaker toggles (Master Carton 24)
493B	Grip Tight™ Lockout Device for standard size breaker toggles (Master Carton 24)
506	Grip Tight™ Breaker Lockout Device Set. Includes one 491B and one 493B (Master Carton 24)
Miniature ISO/DIN Circuit Breaker Devices	
S2390	Miniature Circuit Breaker Lockout Device, Pin Out, Fits Standard 11mm width or less Toggle Openings. Black Handle. (Master Carton 1)
S2391	Miniature Circuit Breaker Lockout Device, Pin Out, Fits 11mm to 13mm Wide Toggle Openings. Red Handle. (Master Carton 1)
S2392	Miniature Circuit Breaker Lockout Device, Pin-in. (Master Carton 1)
S2393	Universal Miniature Circuit Breaker Lockout Device (Master Carton 1)
S2394	Universal Miniature Circuit Breaker Lockout Device, Tool-Free (Shelf Pack 12; Master Carton 144) [†]
Plug	
487	Electrical Plug Cover Small - 110-120 and 220-240 volt plugs (Master Carton 6)
488	Electrical Plug Cover Large - 240 and 550 volt plugs (Master Carton 6)
S2005	Compact Plug Prong Lockout - 110 and 120 volt plugs with or without ground (Master Carton 1)

[†] 10% upcharge does not apply for less than Master Carton quantity



488



496B



S2151



S1010



S1017

1457VE410KA

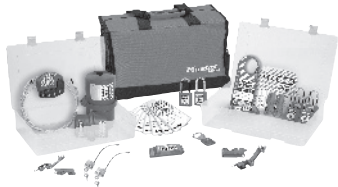

1458E410



1458VE410

Switch, Plug, Control & Button Covers (Commercial Boxed and Bagged Products)

Product Number	Description
Wall Switch	
496B	Universal Wall Switch Cover for toggle and paddle switches (Master Carton 24)
Plug	
453L	Lockout Device Cinch Sack - 7in (17.8cm) diameter x 17in (43.2cm) tall (Master Carton 6)
453XL	Extra Large Lockout Device Cinch Sack - 10in (25.4cm) diameter x 26in (66cm) tall (Master Carton 6)
Rotary/Push Button	
S2151	Retro-fit Rotary and Push Button Cover (Shelf Pack 6 units; Master Carton 24 units)
S2152AST	Set of 12 Full Moon Install Bases for S2151 (Master Carton 24 units)
S2153	Install Rotary and Push Button Cover (Shelf Pack 6 units; Master Carton 24 units)
S2154AST	Set of 12 Half Moon Retrofit Install Bases for S2151 (Master Carton 24 units)

Lockout Kits (Commercial Boxed Products)

Product Number	Description
S1010	Compact Lockout Pouch with Electrical Focus (unfilled) (Master Carton 1)
S1010E410	Compact Lockout Pouch with Electrical Focus. One 410RED padlock, one 7C5RED circuit breaker padlock, one 420 hasp, two 493B circuit breaker lockout, one 491B circuit breaker lockout, one 497A lockout tags, one S1010 pouch (Master Carton 1)
1456	Personal Lockout Pouch (unfilled) (Master Carton 4)
S1017	17in (43.2cm) Wide Lockout Toolbox (unfilled) (Master Carton 1)
S1023	23in (58.4mm) Wide Lockout Toolbox (unfilled) (Master Carton 1)
1457E410KA	Portable Safety Carry Case (No. S1017) with Electrical Lockout Assortment & three Keyed Alike 410RED Padlocks. (Master Carton 1)
1457V410KA	Portable Safety Carry Case (No. S1017) with Valve Lockout Assortment & three Keyed Alike 410RED Padlocks. (Master Carton 1)
1457VE410KA	Portable Safety Carry Case (No. S1017) with Valve and Electrical Lockout Assortment & three Keyed Alike 410RED Padlocks. (Master Carton 1)
1458	Portable Safety Organizer - Large (Master Carton 1)
1458E410	Portable Safety Organizer with Electrical Lockout Assortment. Six 410RED Zenex™ Thermoplastic Padlocks Keyed Different. (Master Carton 1)
1458VE410	Portable Safety Organizer with Valve & Electrical Lockout Assortment. Six 410RED Zenex™ Thermoplastic Padlocks Keyed Different. (Master Carton 1)



S1900VE410

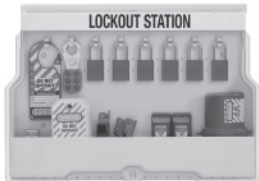

S1850E1106



S1800



S1850E410ES

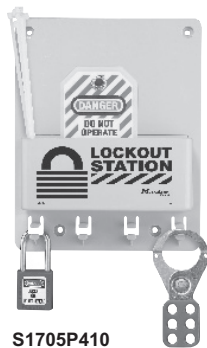

S1705P410

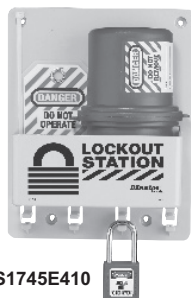

S1745E410

Lockout Stations (Commercial Boxed Products)

Product Number	Description
English Only	
S1800	Deluxe Tag Center (Unfilled) (Master Carton 1)
S1850	Lockout Station (Unfilled) (Master Carton 1)
S1850E410	Lockout Station with Electrical Lockout Assortment and six 410RED Zenex™ Thermoplastic Padlocks (Master Carton 1)
S1850E1106	Lockout Station with Electrical Lockout Assortment and six A1106RED Aluminum Padlocks (Master Carton 1)
S1900	Deluxe Lockout Station (Unfilled) (Master Carton 1)
S1900VE410	Deluxe Lockout Station with Valve and Electrical Lockout Assortment and six 410RED Zenex™ Thermoplastic Padlocks (Master Carton 1)
Bilingual English/Spanish	
S1850ES	Lockout Station (Unfilled) (Master Carton 1)
S1850E410ES	Lockout Station with Electrical Lockout Assortment and six 410RED Zenex™ Thermoplastic Padlocks (Master Carton 1)
S1850E1106ES	Lockout Station with Electrical Lockout Assortment and six A1106RED Aluminum Padlocks (Master Carton 1)
S1850V410ES	Lockout Station with Valve Lockout Assortment and six 410RED Zenex™ Thermoplastic Padlocks (Master Carton 1)
S1850V1106ES	Lockout Station with Valve Lockout Assortment and six A1106RED Aluminum Padlocks (Master Carton 1)
S1900ES	Deluxe lockout Station (Unfilled) (Master Carton 1)
S1900VE410ES	Deluxe Lockout Station with Valve and Electrical Lockout Assortment and six 410RED Zenex™ Thermoplastic Padlocks (Master Carton 1)
S1900VE1106ES	Deluxe Lockout Station with Valve and Electrical Lockout Assortment and six A1106RED Aluminum Padlocks (Master Carton 1)

Also available Bilingual English/French. Replace "ES" with "FRC"

Compact Lockout Stations (Commercial Boxed Products)

Product Number	Description
S1700	Compact Lockout Station (Unfilled) (Master Carton 1)
S1705P410	Compact Lockout Station with one 410RED Zenex™ Thermoplastic Padlock, 1 Hasp, and 2 Tags. (Master Carton 1)
S1720E410	Compact Lockout Station with two 410RED Zenex™ Thermoplastic Padlocks, 4 Tags, 2 491B and 2 493B Circuit Breaker Lockouts. (Master Carton 1)
S1745E410	Compact Lockout Station with one 410RED Zenex™ Thermoplastic Padlock, 1 488 and 1 Tag. (Master Carton 1)

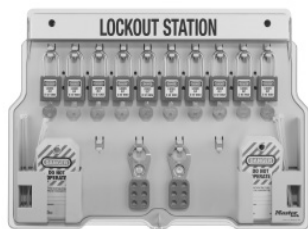

1483BP410



1484BP1106ES



1482BP410ES

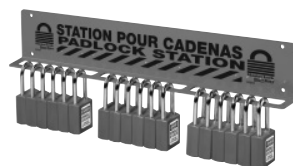

S1518 Shown with 410RED

Padlock Stations (Commercial Boxed Products)

Product Number	Description
English Only	
1482B	4 Padlock Station with Cover - Unfilled (Master Carton 1)
1482BP410	4 Padlock Station with Cover. Four 410RED Zenex™ Thermoplastic Padlocks, 2 Hasps, 12 Tags. Keyed Different. (Master Carton 1)
1482BP1106	4 Padlock Station with Cover. Four A1106RED Aluminum Padlocks, 2 Hasps, 12 Tags. Keyed Different. (Master Carton 1)
1483B	10 Padlock Station with Cover - Unfilled (Master Carton 1)
1483BP410	10 Padlock Station with Cover. Ten 410RED Zenex™ Thermoplastic Padlocks, 2 Hasps, 24 Tags. Keyed Different. (Master Carton 1)
1483BP1106	10 Padlock Station with Cover. Ten A1106RED Aluminum Padlocks, 2 Hasps, 24 Tags. Keyed Different. (Master Carton 1)
1484B	20 Padlock Station with Cover - Unfilled (Master Carton 1)
1484BP410	20 Padlock Station with Cover. Twenty 410RED Zenex™ Thermoplastic Padlocks, 4 Hasps, 48 Tags. Keyed Different. (Master Carton 1)
1484BP1106	20 Padlock Station with Cover. Twenty A1106RED Aluminum Padlocks, 4 Hasps, 48 Tags. Keyed Different. (Master Carton 1)
Bilingual English/Spanish	
1482BES	4 Padlock Station with Cover - Unfilled (Master Carton 1)
1482BP410ES	4 Padlock Station with Cover. Four 410RED Zenex™ Thermoplastic Padlocks, 2 Hasps, 12 English/Spanish Tags. Keyed Different. (Master Carton 1)
1482BP1106ES	4 Padlock Station with Cover. Four A1106RED Aluminum Padlocks, 2 Hasps, 12 English/Spanish Tags. Keyed Different. (Master Carton 1)
1483BES	10 Padlock Station with Cover - Unfilled (Master Carton 1)
1483BP410ES	10 Padlock Station with Cover. Ten 410RED Zenex™ Thermoplastic Padlocks, 2 Hasps, 24 English/Spanish Tags. Keyed Different. (Master Carton 1)
1483BP1106ES	10 Padlock Station with Cover. Ten A1106RED Aluminum Padlocks, 2 Hasps, 24 English/Spanish Tags. Keyed Different. (Master Carton 1)
1484BES	20 Padlock Station with Cover - Unfilled (Master Carton 1)
1484BP410ES	20 Padlock Station with Cover. Twenty 410RED Zenex™ Thermoplastic Padlocks, 4 Hasps, 48 English/Spanish Tags. Keyed Different. (Master Carton 1)
1484BP1106ES	20 Padlock Station with Cover. Twenty A1106RED Aluminum Padlocks, 4 Hasps, 48 English/Spanish Tags. Keyed Different. (Master Carton 1)

Also available Bilingual English/French. Replace "ES" with "FRC"

Heavy Duty Padlock Racks (Commercial Boxed and Bagged Products)

Product Number	Description
S1506	Powder Coated, Heavy Duty Steel Rack. Holds 6-8 padlocks. English, English/French and English/Spanish Labels
S1518	Powder Coated, Heavy Duty Steel Rack. Holds 18-22 padlocks. English, English/French and English/Spanish Labels

Tag Station (Commercial Boxed and Bagged Products)

Product Number	Description
S1800	Deluxe Tag Station - Unfilled (Master Carton 1)



S1800



S4058



S4002MT



497A



S4802LEN



S4810



Tags (Commercial Boxed and Bagged Products)

Product Number	Description
Guardian Extreme™ Tags, 3in (7.6 cm) x 5-3/4in (14.6cm)	
Danger Tags	
S4002	Standard White Danger Tag - Do Not Operate, (Each bag contains 6) (Shipping Carton Qty 36, 6 Bags)
S4002MT	Metal Detectable White Danger Tag - Do Not Operate, (Each bag contains 6) (Shipping Carton Qty 36, 6 Bags)
S4046	Standard Red Danger Tag - Do Not Operate, (Each bag contains 6) (Shipping Carton Qty 36, 6 Bags)
S4058	Standard White Caution Tag – BLANK -WRITE YOUR OWN MESSAGE, ERASE, & REPEAT, (Each bag contains 6) (Shipping Carton Qty 36, 6 Bags)
Caution Tags	
S4050	Standard Yellow Caution Tag - Do Not Operate This Equipment, (Each bag contains 6) (Shipping Carton Qty 36, 6 Bags)
S4060	Standard Yellow Caution Tag – BLANK - WRITE YOUR OWN MESSAGE, ERASE & REPEAT, (Each bag contains 6) (Shipping Carton Qty 36, 6 Bags)
Laminated Heavy Duty Tags	
497A	Lockout Tags, 5-3/4in x 3-1/8in (14.6cm x 8cm) (Each bag contains 12) Danger - Do Not Operate (Master Carton 160)
497ABLC	French/English Lockout Tags, 5-3/4in x 3-1/8in (14.6cm x 8cm) (Each bag contains 12) Danger - Do Not Operate (Master Carton 160)
497AX	Spanish/English Lockout Tags, 5-3/4in x 3-1/8in (14.6cm x 8cm) (Each bag contains 12) Danger - Do Not Operate (Master Carton 160)
Self Laminating Tags	
S4800LES	Spanish Self Laminating Lockout Tags with European Danger Symbol (Each bag contains 12) Danger - Do Not Operate (Master Carton 6)
S4801	English Self Laminating Lockout Tags (Each bag contains 12) Danger - Do Not Operate (Master Carton 6)
S4802LEN	English Self Laminating Lockout Tags with U.K. Prohibition Symbol (Each bag contains 12) Danger - Do Not Operate (Master Carton 6)
Boxed Roll of Tags	
S4810	Perforated Roll of Danger - Do Not Operate polypropylene tags, 6in x 3in (153mm x 76mm), (Each box contains 100 tags), English (Master Carton 12)
S4810LES	Perforated Roll of Danger - Do Not Operate polypropylene tags, 6in x 3in (153mm x 76mm), (Each box contains 100 tags), Spanish (Master Carton 12)
S4810LFR	Perforated Roll of Danger - Do Not Operate polypropylene tags, 6in x 3in (153mm x 76mm), (Each box contains 100 tags), French (Master Carton 12)
S4810LPT	Perforated Roll of Danger - Do Not Operate polypropylene tags, 6in x 3in (153mm x 76mm), (Each box contains 100 tags), Portuguese (Master Carton 12)
S4810LENUK	Perforated Roll of Danger - Do Not Operate polypropylene tags, 6in x 3in (153mm x 76mm), (Each box contains 100 tags), English - United Kingdom (Master Carton 12)
Maintenance Tags	
S297	Maintenance Tags, Danger Do Not Operate, 5-1/2in x 1-1/4in (140mm x 32mm), (Each bag contains 100 tags), English (Master Carton 10)
S297LES	Maintenance Tags, Danger Do Not Operate, 5-1/2in x 1-1/4in (140mm x 32mm), (Each bag contains 100 tags), Spanish (Master Carton 10)
S297LFR	Maintenance Tags, Danger Do Not Operate, 5-1/2in x 1-1/4in (140mm x 32mm), (Each bag contains 100 tags), French (Master Carton 10)
S297LENUK	Maintenance Tags, Danger Do Not Operate, 5-1/2in x 1-1/4in (140mm x 32mm), (Each bag contains 100 tags), English - United Kingdom (Master Carton 10)



No. 7126D

- Heavy duty steel construction with full length, hinged door and built-in slotted key racks
- Durable, beige powder coated cabinet finish
- Rekeyable wafer cylinder lock that utilizes our K1 Key with improved pick resistance
- Key retaining security insures key cannot be removed until cabinet is locked
- 2 keys, key holders, cross reference chart and installation hardware included

SAFESPACE® Heavy Duty Locking Key Cabinets (BoxedProducts)

Product Number	Description	Master Carton Quantity
7125D	Heavy Duty Key Cabinet holds 60 keys. 12-1/4in (31.1cm) x 10-3/4in (27.3cm) x 3in (7.6cm)	4
7126D	Heavy Duty Key Cabinet holds 120 keys. 17in (43.2cm) x 13in (33cm) x 3-1/4in (8.3cm)	4



No. 7116D



No. 7117D

- Fits most key cabinets and key racks
- No. 7117 snap hook design fits slotted and key style key cabinets, boards, etc. For use with 7125D and 7126D

SAFESPACE® Plastic Key Tags and Hangers

Product Number	Description	Master Carton Quantity
7116D	Plastic Key Tags; 20 tags per bag. 1-1/4in (32mm) x 1-1/10in (28mm) x 1/2in (12mm)	10 bags
7117D	Plastic Key Holder; 20 holders per bag. 1-1/2in (38mm) x 1-2/3in (42mm) x 4/5in (20mm)	10 bags



1337LGENIND

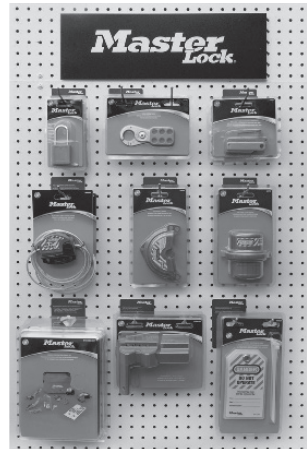

1337SMGENIND



1336ELECT



1336PLMB

Planograms include two of each item, a Master Lock header and a set of re-order tags.

Commercial Products

Product Number	Description	Display Carton Quantity
Safety Lockout Planograms		
1337LGENIND	Large General Industry Lockout Planogram: (2) of each of the following products - S1010DELECKIT Electrical Lockout Kit, S1010DGCKIT General Contractor Lockout Kit, 497AD Lockout Identification Tags, 410TRIRED Keyed-Alike Set of 3 Zenex™ Safety Padlocks, 410DRED Lightweight Zenex™ Safety Padlock, 420DSteel Lockout Hasp, S2394D Miniature Circuit Breaker Lockout, 506D Grip Tight™ Circuit Breaker Lockout Set, 487D Electrical Plug Lockout, 496BD Universal Wall Switch Cover, S806DAdjustable Cable Lockout Device, 480D Gate Valve Lockout, S3081D Adjustable Ball Valve Lockout.	1
1337SMGENIND	Small General Industry Lockout Planogram: (2) of each of the following products - S1010DGCKIT General Contractor Lockout Kit, 497AD Lockout Identification Tags, 410DRED Lightweight Zenex™ Safety Padlock, 420DSteel Lockout Hasp, 506D Grip Tight™ Circuit Breaker Lockout Set, 487D Electrical Plug Lockout, S806DAdjustable Cable Lockout Device, 480D Gate Valve Lockout, S3081D Adjustable Ball Valve Lockout.	1
1336ELECT	Electrical Lockout Planogram: (2) of each of the following products - S1010DELECKIT Electrical Lockout Kit, 497AD Lockout Identification Tags, 410TRIRED Keyed-Alike Set of 3 Zenex™ Safety Padlocks, 410DRED Lightweight Zenex™ Safety Padlock, 420DSteel Lockout Hasp, S2394D Miniature Circuit Breaker Lockout, 506D Grip Tight™ Circuit Breaker Lockout Set, 487D Electrical Plug Lockout, 496BD Universal Wall Switch Cover, S806DAdjustable Cable Lockout Device.	1
1336PLMB	Plumbing Lockout Planogram: (2) of each of the following products - 497AD Lockout Identification Tags, 410TRIRED Keyed-Alike Set of 3 Zenex™ Safety Padlocks, 410DRED Lightweight Zenex™ Safety Padlock, 420DSteel Lockout Hasp, 506D Grip Tight™ Circuit Breaker Lockout Set, 487D Electrical Plug Lockout, S806DAdjustable Cable Lockout Device, 480D Gate Valve Lockout, S3081D Adjustable Ball Valve Lockout.	1

All of the carded safety padlocks, devices and tags listed are available for purchase separately to replenish or expand your planogram and enhance your showroom. Carded commercial security products and commercial security planograms are also available.

Safety Carded Products (Commercial Boxed Products)

Product Number	Description	Master Carton Quantity
410DRED	Lightweight Zenex™ Safety Padlock	6
410TRIRED	Keyed-Alike Set of 3 Zenex™ Safety Padlocks	6
420D	Steel Lockout Hasp	6
480D	Gate Valve Lockout	6
487D	Electrical Plug Lockout	6
496BD	Universal Wall Switch Cover	6
497AD	Lockout Identification Tags	6
506D	Grip Tight™ Circuit Breaker Lockout Set	6
S806D	Adjustable Cable Lockout Device	6
S1010DELECKIT	Electrical Lockout Kit	4
S1010DGCKIT	General Contractor Lockout Kit	4
S2394D	Miniature Circuit Breaker Lockout	6
S3081D	Adjustable Ball Valve Lockout	6



REDUCE. REUSE. RECYCLE.

Master Lock is proud to do all three

PROTECTING PEOPLE AND THE PLANET:

Our Master Lock Safety padlocks use FDA compliant lubricants, which are safe for use in food processing facilities.

Additionally, Master Lock manufactures the majority of Safety padlock components in our ISO 9001 North American facilities.

Master Lock is committed to stewardship of the environment, to the people who make and use our safety products, and to the communities where they are made and used.

A NUMBER OF MASTER LOCK PRODUCTS HAVE BEEN UL ENVIRONMENT VERIFIED FOR RECYCLED CONTENT.

UL Environment works to advance global sustainability by supporting the growth and development of environmentally preferable products, services and organizations.



REDUCE

Our Master Lock Safety Zenex™ padlock bodies are molded using a hot runner injection molding process that results in virtually no scrap material.



REUSE

Precision engineering, durable materials and recommended padlock maintenance ensure all Master Lock Safety padlocks are long lasting.



RECYCLE

Master Lock Safety padlocks use a significant percentage of recycled metal. Steel shackles, brass keys and cylinders, as well as our aluminum lock bodies are all manufactured using recycled material.

Our customer services and key management systems build better safety programs.

EMPLOYEE OR FACILITY IDENTIFICATION

LASER ENGRAVING
Provides a permanent method for customizing lockout padlocks with a name, logo or key number. Available with Thermoplastic and Aluminum padlocks

PHOTO ID LABELS
Achieve immediate user recognition. Available for all Thermoplastic and Aluminum locks



MAKE-TO-ORDER CAPABILITY

Built and keyed to your requirements

LOCK BODIES & SHACKLES
Choose extra length shackles and specific body types



WRITE-ON LABELS
Provide both lockout warning message and space for employee name. These are standard with Thermoplastic padlocks (wrap-around style is available for Steel padlocks)

KEYING FLEXIBILITY

Only Master Lock offers you the convenience of Keyed Different, Keyed Alike or Master Keyed in EVERY Safety Padlock. Over 100,000 possible key changes ensures no duplicates within your facility.

EXCLUSIVE SAFETY MASTER KEY SYSTEMS

Select the Master Key system that best meets your current and future safety lockout needs. Available in the W417 Safety Master Key keyway which is standard in the 410MK, 406MK and 411MK padlocks. Optional in A1160MK series padlocks.

SYSTEM AA



15,000
Keyed Alike and Keyed Different Codes Available

SYSTEM B



1 – 25 Master Keys

225
Keyed Alike and Keyed Different Codes Available Under Each Master Key in System B

SYSTEM C



1 – 6 Master Keys

2400
Keyed Alike and Keyed Different Codes Available Under Each Master Key in System C

LifeGuard

ASSURE SAFETY PADLOCK SYSTEM INTEGRITY

Ensure no unwarranted duplication of keys within a facility. Master Lock Company keeps a complete record of all key codes assigned and manufactured into the padlocks of Registered End Users.

CUSTOM SYSTEM DESIGNS AVAILABLE TO MEET UNIQUE SYSTEM REQUIREMENTS



Retail Carded Price List



Effective November 15, 2019

Master Lock

Master Lock offers the widest range of strong, easy-to-use, and reliable security products people trust to protect their most valued assets.



Around the Home

Give consumers the confidence to protect the things they've earned. From padlocks to cable locks, door hardware, Master Lock Vault® and more, there's a product for every home security need.



School, Gym & Health Club

The broadest selection of innovative and easy-to-use portable locks with the features and functionalities people know and trust to keep their belongings safe.



Bike

Whether it's to school, to work, for sport or pleasure, we offer cyclists a wide variety of strong and easy-to-use options to lock up their ride with confidence.



Travel

TSA accepted locks and personal portable safes available in a variety of colors, styles with resettable combinations provide convenience and peace of mind for travelers.



Vehicle

Help people protect their tools, property, and vehicles with our extensive lineup of rugged and reliable automotive, towing and powersports security products.



Storage Security & Lock Boxes

Give your customers the freedom to control access to their property and the peace of mind of always knowing their keys, fobs or access cards are secure.

PRICE BOOK CONTENTS

TERMS OF SALE	1
SPEED INDEX	3
ORDERING INFORMATION	7
RETAIL PRODUCTS BY PRODUCT CATEGORY	
■ Packaging Features	8
■ Electronic Security Products	
• <i>Bluetooth</i> [®] Padlocks	9
• <i>Bluetooth</i> [®] Lock Boxes	9
■ Stainless Steel Pin Tumbler Padlocks	10
■ Laminated Steel Pin Tumbler Padlocks	13
■ Weather Resistant Laminated Steel Padlocks	15
■ Laminated Brass Pin Tumbler Padlocks	16
■ Rust-Oleum [®] Certified Padlocks	16
■ Fusion [™] Padlocks	17
■ Shrouded Padlocks	17
■ Solid Body Padlocks	
• Brass	19
• Covered	20
• Chrome	21
• Die-Cast Zinc	21
• Aluminum	21
■ <i>Bluetooth</i> [®] Padlocks	22
■ Set Your Own Combination Padlocks	23
■ Combination Padlocks	26
■ Magnification Combination Padlocks	27
■ Backpack Locks	28
■ Carabiners	28
■ Luggage Padlocks	29
■ TSA-Accepted Luggage Padlocks	30
■ Password Padlocks	34
■ Warded Padlocks	35
■ Gun Locks	36
■ U-Locks	37
■ Chains and Chain Locks	39
■ Cables and Cable Locks	41

■ Towing Security	
• Receiver Pins and Clips	47
• Coupler Locks	47
• Receiver Locks	48
• Keyed Alike Sets	48
• Spare Tire Locks and Cable/Lock Sets	48
■ Vehicle Security	
• Steering Wheel Locks	49
• Cable and Cable Locks	49
■ Truck Bed Security	
• Tailgate Lock	50
■ Cargo Security	
• Bungee Cords	50
• Ratchet Tie-Downs	53
• Spring Clamp Tie-Downs	54
• Cargo Net	54
■ Power Sport Series	55
■ Security Bar	57
■ Storage Security	
• SafeSpace [®] Portable Personal Safes	57
• SafeSpace [®] Key Tags and Hangers	57
• SafeSpace [®] Bluetooth [®] Lock Boxes	58
• SafeSpace [®] Lock Boxes	59
• SafeSpace [®] Storage Bags	60
• SafeSpace [®] Key Case	60
■ Hasps	61

FORTRESS [®] SERIES	64
------------------------------------	----

KEY BLANKS	67
------------------	----

KEY CUTS	68
----------------	----

KEY BLANKS FOR PRO SERIES [®]	69
--	----

SPEED INDEX

Product Number	Page Number	Shelf Pack Quantity	Master Carton Quantity
1D	13	4	24
1DEX	18	4	24
1DLF	13	4	24
1DLH	13	4	16
1DLJ	13	6	24
1SSKADLF	10	—	6
1SSKADLH	10	—	6
1SSQLF	10	—	6
1SSTLF	10	—	6
1SSTRILH	10	—	6
1TLF	13	4	16
1TLH	13	4	16
1TRILJ	13	4	16
3D	13	4	24
3DEX	18	4	24
3DLF	13	4	24
3DLH	13	6	36
3QLF	13	4	16
3SSKAD	10	—	6
3SSKADLF	10	—	6
3SSQ	10	—	6
3SSQLF	10	—	6
3SST	10	—	6
3T	13	4	16
3TRILF	13	4	24
4D	16	6	36
5D	14	4	24
5DLJ	14	4	16
5SSKAD	11	6	36
5SSKADLJ	11	6	36
5SSQLJ	11	6	36
5SST	11	6	36
5SSTLJ	11	6	36
5T	14	6	24
5TLF	14	4	16
5TRILFPF	14	4	16
5TRILJ	14	4	16
7D	14	4	24
10D	35	4	24
15SSKADLJ	11	—	6
15SSTLJ	11	—	6
22D	35	4	24
22T	35	4	16

Product Number	Page Number	Shelf Pack Quantity	Master Carton Quantity
37D	18/47	4	24
37KA	47	6	24
40DPF	18	4	24
40KADPF	18	6	36
40T	18	4	16
40TRI	18	4	16
61DAT	49	4	16
65D	45	2	16
67D	45	—	12
72DPF	45	—	4
73D	39	—	12
78DPF	45	4	16
85DPF	45	4	16
90DSPT	36	4	24
90KADSPT	36	4	24
90TRISPT	36	4	24
94DSPT	36	4	24
99DSPT	36	4	24
99KADSPT	36	4	24
105D	35	4	24
107DSPT	37	4	24
107KADSPT	37	4	24
120D	19	4	24
120KAD	19	6	72
120Q	19	4	16
120T	19	4	24
121T	20	4	24
130D	19	4	24
130KAD	19	6	36
131D	20	4	24
131Q	20	4	16
131T	20	4	16
132DCM	20	4	24
136T	20	4	16
140D	19	4	24
140DLF	19	6	36
140DLH	19	6	36
140KAD	19	6	36
140Q	19	4	16
140QLH	19	4	16
140T	19	6	24
141D	20	4	24
141DLF	20	4	24

NOTE: Speed Index does not include all products. See individual product pages for complete listing.

SPEED INDEX

Product Number	Page Number	Shelf Pack Quantity	Master Carton Quantity
141T	20	4	16
141TRILF	20	4	16
142DCM	20	4	24
146D	20	4	24
150D	19	4	24
160D	19	4	24
175D	23	4	24
175DLH	23	6	36
175DLHWD	23/34	4	24
175DWD	23/34	4	24
178D	23	4	24
185D	17	4	24
187XD	17	4	24
192D	17	4	24
207D	60	4	24
252DAT	49	—	2
256DAT	49	—	4
262DAT	48	4	24
263DAT	49	—	4
265DCCSEN	57	—	3
311D	15	4	24
311SSKADLF	12	—	6
311SSKADLH	12	—	6
311SSTRILF	12	—	6
311TRI	15	4	16
312D	15	4	24
312DLH	15	4	24
312TRI	15	4	16
315SSKAD	12	—	6
317DSPT	15	4	24
357D	65	4	24
370DAT	47	4	24
371DAT	47	4	24
377DAT	47	—	4
377KA	47	—	4
379ATPY	47	—	6
379DAT	47	—	2
379KAATPY	47	—	6
380D	16	4	24
380T	16	4	16
389DAT	47	—	2
450D	61	4	24
500D	35	4	24

Product Number	Page Number	Shelf Pack Quantity	Master Carton Quantity
510D	35	4	24
510KAD	35	4	24
517D	35	4	24
517KAD	35	4	24
527D	20	4	24
532DPFSEN	21	4	24
570DLHPF	21	4	24
575DPF	19	4	24
576DLHPF	19	4	24
603D	28	4	24
605DAT	47	4	24
613DAT	48/49	4	16
614DAT	48/49	4	24
620D	29	4	24
620DAST	29	4	24
627D	66	4	24
630D	29	4	24
630DAST	29	4	24
643D	29	4	24
643DASTWD	29/34	4	24
643DWD	29/34	4	24
646D	29	4	24
646T	29	4	16
647D	29	4	24
653D	23	4	24
702D	61	4	24
703D	61	4	24
704DPF	61	4	24
706D	61	4	24
715DAT	49	4	24
716D	40	6	48
719D	46	6	48
720DPF	61	4	24
722DPF	61	4	24
730DPF	61	4	24
732DPF	61	4	24
875D	23	4	24
875DLH	23	4	24
911DPF	15	4	24
930DPF	21	4	24
930DLHPF	21	4	24
1273CARSM	28/63	—	1
1376DAT	47	4	24

SPEED INDEX

Product Number	Page Number	Shelf Pack Quantity	Master Carton Quantity
1414DAT	47	4	24
1415DAT	47	6	24
1465DAT	47	4	24
1469DAT	48	4	24
1470DAT	48	—	4
1471DAT	47	4	24
1472DAT	48	4	24
1479DAT	48	4	24
1479TAT	48	4	16
1480DAT	48	4	24
1480KA	48	4	24
1481DAT	48	4	24
1491DAT	47	6	24
1492DAT	47	4	24
1495DAT	47	4	24
1500D	26	6	24
1500DCOV	26	4	24
1500iD	24	4	16
1500iDPNK	24	4	16
1500T	26	4	16
1503DCOV	26	4	24
1504D	26	4	24
1505D	26	4	24
1506D	26	4	24
1517D	26	6	48
1519D	46	6	48
1530DCM	27	4	24
1530DPNK	27	4	24
1530T	27	4	16
1533TRI	27	4	16
1534D	25/34	4	16
1535D	25	4	16
1535DWD	25/34	4	16
1547DCM	28	4	24
1548DCM	28	4	24
1550DAST	28	4	24
1561DAST	27	4	24
1588D	27	4	24
1588T	27	4	16
1590D	24/34	4	16
1665DAT	47	4	24
1803D	64	4	24
1803DLF	64	4	24

Product Number	Page Number	Shelf Pack Quantity	Master Carton Quantity
1803Q	64	4	16
1803T	64	4	16
1804D	64	4	24
1804TRI	64	4	16
1805D	64	4	24
1805T	64	4	16
1805TRI	64	4	16
1807D	64	4	24
1820Q	66	4	16
1820T	66	4	16
1825D	66	4	24
1830D	66	4	24
1830T	66	4	16
1840D	66	4	24
1840DLF	66	4	24
1840Q	66	4	16
1840T	66	4	16
1850D	65	4	24
2469DAT	48	4	24
2847DAT	47	4	24
2848DAT	48	4	24
2866DAT	48	4	24
2878DAT	47	4	24
2999DAT	47	4	12
3008D	13	4	16
3009D	35	4	16
3018DAT	52	12	72
3019DAT	52	6	72
3020DAT	52	6	72
3021DAT	52	6	72
3023AT	52	—	6
3026DAT	52	6	48
3029DAT	51	6	72
3030DAT	51	6	72
3031DAT	51	6	72
3039DAT	50	6	48
3041DAT	51	—	4
3044DAT	53	—	4
3052DAT	54	—	2
3053DAT	54	3	6
3054DAT	53	—	4
3057DAT	54	—	4
3113DAT	54	—	4

NOTE: Speed Index does not include all products. See individual product pages for complete listing.

SPEED INDEX

Product Number	Page Number	Shelf Pack Quantity	Master Carton Quantity
3120DAT	52	—	25
3156DAT	53	—	4
3784DAT	47	—	2
3794DAT	48	—	2
3895DAT	48	—	2
4400D	9/22	2	8
4401DLH	9/22	2	8
4603D	44	4	24
4605D	44	4	24
4680DBLK	31	4	24
4680DNKL	31	4	24
4681TBLK	30	4	16
4681TBLR	30	4	16
4683Q	30	4	16
4684T	31	4	16
4688D	31	4	24
4688T	31	4	16
4689Q	30	6	16
4689T	30	4	16
4691DWD	32/34	4	24
4692D	32	4	24
4696D	32	4	24
4696DWD	32/34	4	24
4696T	32	4	16
4696TWD	32/34	4	16
4697D	33	4	24
4697DWD	33/34	4	24
5400D	59	—	4
5401D	59	—	4
5406D	59	2	4
5408D	59	4	16
5420D	59	—	4
5422D	60	—	4
5423D	60	—	4
5424D	58	—	4
5425D	58	—	4
5440D	9/58	1	2
5441D	9/58	1	2

Product Number	Page Number	Shelf Pack Quantity	Master Carton Quantity
5900D	57	1	2
5900DWHT	57	1	2
7116D	57	—	10
7117D	57	—	10
7120D	60	—	6
8109D	42	2	12
8114D	44	4	12
8118DPF	38/55	4	24
8119DPF	44	4	16
8122D	44	4	12
8126D	42	4	12
8127TRI	42	—	4
8142DAT	49	4	16
8143D	44	6	24
8147D	40	6	48
8152DASTWD	34/44	6	24
8154DPF	42	4	16
8155DCC	43	—	4
8157DPS	43/56	—	4
8170D	38	—	6
8174DLWPF	39	4	12
8184D	38	4	12
8195D	37	4	12
8218DPS	43/56	4	12
8220D	34/44	4	12
8253DAT	50	1	4
8290DPS	55	—	6
8291DPS	40/55	—	4
8303DPS	56	4	12
8304DPS	56	4	12
8413DPF	41	—	6
8417D	42	—	6
8418D	42	—	4
8418KADCAMO-TMB	42	—	4
8419DPF	42	—	4
8428DPS	41/56	—	6
8525T	65	4	16

ORDERING INFORMATION

ORDERING INFORMATION

Key Number Range By Products

- Each Master Lock padlock has its own specific numbered key number. The products and appropriate key numbers are listed below.
- To order a specific key number, specify product number followed by a key number. If no key number is indicated, Master Lock will select a random key number from the appropriate range.

Example: 12 No. 5KA = 12 No. 5 padlocks keyed alike to a randomly-selected key number in range A101-A2084.
 12 No. 5KA A101 = 12 No. 5 padlocks keyed alike to key number A101 and receive forecast and Point of Sale (POS) data via EDI.

INDIVIDUAL KEY NUMBERS			
Padlock Body	Key Number	Padlock Body	Key Number
1 & 2	2001 - 2997 X2000 - X2998	15, 220 & 230	10N001 - 19N950
3, 4, 37, 40, 311, 312 & 317	3030 - 3999 0301 - 0950	21, 25, 31 & 101	10L001 - 19L616
5 & 6	A101 - A2084	81, 82, 532, 570 & 575,	10R01 - 109R10
7, 8, 90, 185, 716, 719 & 1807D	P104 - P851 K1973 - K2924	911, 930 & 931	10Z001 - 19Z950

INDIVIDUAL MASTER KEY NUMBERS			
Padlock Body	Key Number	Padlock Body	Key Number
1 & 2	MK MK2K	7100 - 7939 X2000 - X2998	15MK 20N001 - 25N616
3, 4, 37 & 312	MK MK2K	E100 - E699 E1000 - E6990	21MK, 25MK, 31MK, 220MK & 230MK
5 & 6	MK MK2K	J301 - J996 J3010 - J5990	81MK & 82MK 10M01 - 97M56
7MK & 8MK		N200 - N367 X368 - X785	

Keying Options

- Keyed Alike (KA)** - This provides "same key" convenience and eliminates the need for multiple keys where numerous padlocks are used. All padlocks in the set are keyed the same. Most Master Lock padlocks can be ordered keyed alike. Keyed alike padlocks are listed in this price book with a "KA" suffix in the product number.
- Master Keyed (MK)** - In a master keyed system, the master key opens all locks in the system although each lock has its own unique key. Master keyed items are ideal for permitting supervisory or emergency access. Master keyed padlocks are listed in this price book with an "MK" suffix in the product number.
- Rekeyable Padlocks** - Padlock cylinders can be removed and replaced to restore security quickly without requiring a new padlock. This is ideal for situations where keys are lost or stolen due to theft or employee turnover. Rekeyable padlocks are found in the commercial price book.
- Reserved Key Systems (RSV)** - Reserved key padlocks are not available to the general public and are not listed in this price book. Key blanks and cut keys are supplied directly by Master Lock through distributors and dealers when requested by registered end users. This adds security through the restricted distribution of duplicate keys. This option requires a custom quotation (see page 1).
- ML Line Patent Key Control** - Keys for this patent pending key control product offer the ultimate protection against unauthorized duplicate keys. Blank keys are available to locksmiths only and controlled by contract. These keys are recommended for all master key applications. Contact your local locksmith for full details.
- Non-Removable Key (NR)** - The key cannot be removed from the padlock when the padlock is open. This helps prevent users from accidentally leaving the padlock in the open position. Only selected padlocks offer this option.

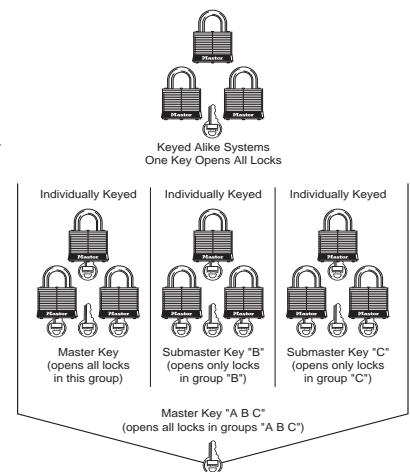

Key Number Range By Products

- Special Marking** - Key numbers or other customer specific information may be stamped or laser engraved on the padlock or key for identification. This is useful for recording company owned padlocks as well as identifying employees using specific padlocks. Please call your Master Lock sales representative for details on laser engraving. Other customer specific information requires a custom quotation (see page 1).
- Color Coding** - Some padlocks are available with colored bumpers or lock bodies for easy department identification.
- Key Number Maintenance (Charting)** - Master Lock will maintain records of your key system for future reference. This is useful when reordering padlocks to current keyed different, keyed alike, master keyed, or safety lockout systems. This option requires a custom quotation (see page 1).
- Chain and Tag Attachments** - Small chains may be attached to padlock shackles in order to affix padlocks to truck doors, gates, equipment, or other applications. Brass tags may be affixed to padlocks for identification purposes. These items are available separately (see Commercial Price Book) or can be attached at the factory. The factory-attached option requires a custom quotation (see page 1).

RETAIL PRODUCTS

Retail Carded Packaging - Hardware

Master Lock offers a variety of products packaged for self-service display in the retail marketplace. The card graphics have been carefully designed to help consumers with their security applications. Clamshell structure helps package stay attractive and secure from carton to check-out counter.



FRONT

- Tough Under Fire medallion symbolizes Master lock security
- Bold logo communicates premium performance
- Icon packaging simplifies the shopping process and consistently communicates the performance benefits and differentiating product features

BACK

- Suggested uses facilitate product selection
- Cutaway diagram illustrates Master Lock quality
- UPC Code facilitates inventory control





Master Lock *Bluetooth*® Padlocks and Lock Boxes offer the freedom to protect and control access to homes, businesses or vacation properties right from your smartphone. The free and intuitive Master Lock Vault® app allows users to assign who can access their property, and for how long. It's the smart, simple and flexible way to confidently secure property and manage access from anywhere at any time.



- No need to worry over lost keys or forgotten combinations!
- Enjoy improved speed and ease of use with free app
- Gain greater flexibility and control—share limited or permanent access with others
- Monitor access history and receive notifications
- Directional keypad allows for backup mechanical access
- Receive low battery notifications on padlock and in app

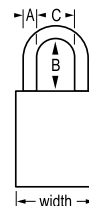

Bluetooth® Padlocks

Product Number	Description	Shelf Pack Quantity	Master Carton Quantity	Shackle Dimensions			Shackle Dimensions (Metric)		
				A	B	C	A	B	C
1-29/32in (47mm) wide									
4400D	Indoor Use Only	2	8	9/32in	7/8in	13/16in	7mm	22mm	20mm
2-7/32in (56mm) wide									
4401DLH	Outdoor Weather Resistance, 2in (51mm) Shackle	2	8	11/32in	2in	15/16in	9mm	51mm	23mm



- Open and manage lock boxes with your smartphone
- Share permanent or temporary access with the Master Lock Vault app, or manual codes
- Monitor access history and receive notifications
- Optional manual code access via keypad when smartphone is not available
- Receive low battery notifications on lock box and in app

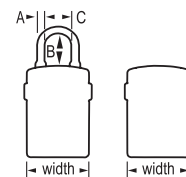

Bluetooth® Lock Boxes

Product Number	Description	Shelf Pack Quantity	Master Carton Quantity	Shackle Dimensions			Shackle Dimensions (Metric)		
				A	B	C	A	B	C
5440D	3-1/4in wide, Bluetooth® Portable Lock Box	1	2	13/32in	1-13/16in	1-13/32in	10mm	46mm	36mm
5441D	3-1/4in wide, Bluetooth® Wall Mount Lock Box	1	2	NA	NA	NA	NA	NA	NA

PLEASE SEE MASTER LOCK COMMERCIAL PRICE BOOK FOR KEYED ALIKE ITEMS

KEY BLANKS: See pages 67-69 for respective key blanks or cut key information.

RETAIL PRODUCTS AVAILABLE ONLY IN MASTER CARTON OR SHELF PACK QUANTITIES.

STAINLESS STEEL PIN TUMBLER PADLOCKS



No. 1SSKADLF No. 1SSKADLH

- 1-3/4in (44mm) wide laminated stainless steel body for maximum strength
- Stainless steel lock body and shackle delivers the maximum weather resistance available
- Ball bearing locking for maximum pry resistance
- 4-pin tumbler cylinder for increased weather and pick resistance

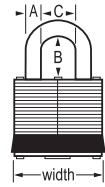

Stainless Steel No. 1 Padlocks

Product Number	Description	Shelf Pack Quantity	Master Carton Quantity	Shackle Dimensions			Shackle Dimensions (Metric)		
				A	B	C	A	B	C
1SSKADLF	Keyed Alike; 1-1/2in (38mm) Shackle	—	6	5/16in	1-1/2in	3/4in	8mm	38mm	19mm
1SSTLF	2-Pack of No. 1SSLF Keyed Alike	—	6	5/16in	1-1/2in	3/4in	8mm	38mm	19mm
1SSQLF	4-Pack of No. 1SSLF Keyed Alike	—	6	5/16in	1-1/2in	3/4in	8mm	38mm	19mm
1SSKADLH	Keyed Alike; 2in (51mm) Shackle	—	6	5/16in	2in	3/4in	8mm	51mm	19mm
1SSTRILH	3-Pack of No. 1SSLH Keyed Alike	—	6	5/16in	2in	3/4in	8mm	51mm	19mm



No. 3SSKAD No. 3SSKADLD No. 3SSKADLF

- 1-9/16in (40mm) wide laminated stainless steel body for maximum strength
- Stainless steel shackle and weather coated finish for improved weather resistance
- Ball bearing locking for maximum pry resistance
- 4-pin tumbler cylinder for increased weather and pick resistance

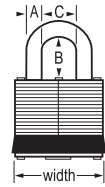

Stainless Steel No. 3 Padlocks

Product Number	Description	Shelf Pack Quantity	Master Carton Quantity	Shackle Dimensions			Shackle Dimensions (Metric)		
				A	B	C	A	B	C
3SSKAD	Keyed Alike	—	6	9/32in	3/4in	5/8in	7mm	19mm	16mm
3SST	2-Pack of No. 3SS Keyed Alike	—	6	9/32in	3/4in	5/8in	7mm	19mm	16mm
3SSQ	4-Pack of No. 3SS Keyed Alike	—	6	9/32in	3/4in	5/8in	7mm	19mm	16mm
3SSKADLF	Keyed Alike; 1-1/2in (38mm) Shackle	—	6	9/32in	1-1/2in	5/8in	7mm	38mm	16mm
3SSQLF	4-Pack of No. 3SSLF Keyed Alike	—	6	9/32in	1-1/2in	5/8in	7mm	38mm	16mm

PLEASE SEE MASTER LOCK COMMERCIAL PRICE BOOK FOR KEYED ALIKE ITEMS

KEY BLANKS: See pages 67-69 for respective key blanks or cut key information.

RETAIL PRODUCTS AVAILABLE ONLY IN MASTER CARTON OR SHELF PACK QUANTITIES.

STAINLESS STEEL PIN TUMBLER PADLOCKS

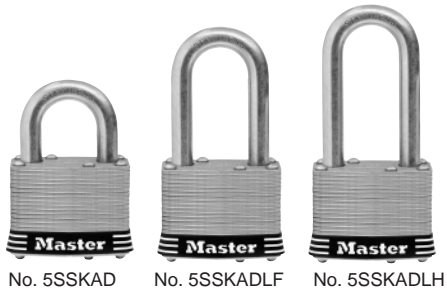

- 2in (51mm) wide laminated stainless steel body for maximum strength
- Stainless steel lock body and shackle delivers the maximum weather resistance available
- Ball bearing locking for maximum pry resistance
- 4-pin tumbler cylinder for increased weather and pick resistance

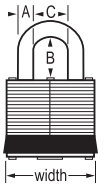

Stainless Steel No. 5 Padlocks

Product Number	Description	Shelf Pack Quantity	Master Carton Quantity	Shackle Dimensions			Shackle Dimensions (Metric)		
				A	B	C	A	B	C
5SSKAD	Keyed Alike	—	6	3/8in	1in	15/16in	10mm	25mm	24mm
5SST	2-Pack of No. 5SS Keyed Alike	—	6	3/8in	1in	15/16in	10mm	25mm	24mm
5SSKADLJ	Keyed Alike; 2-1/2in (64mm) Shackle	—	6	3/8in	2-1/2in	15/16in	10mm	64mm	24mm
5SSTLJ	2-Pack of No. 5SSLJ Keyed Alike	—	6	3/8in	2-1/2in	15/16in	10mm	64mm	24mm
5SSQLJ	4-Pack of No. 5SSLJ Keyed Alike	—	6	3/8in	2-1/2in	15/16in	10mm	64mm	24mm



- 2-1/2in (64mm) wide laminated stainless steel body for maximum strength
- Stainless steel lock body and shackle delivers the maximum weather resistance available
- Ball bearing locking for maximum pry resistance
- 4-pin tumbler cylinder for increased weather and pick resistance

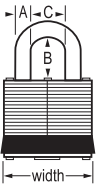

No. 15SSKADLJ

Stainless Steel No. 15 Padlocks

Product Number	Description	Shelf Pack Quantity	Master Carton Quantity	Shackle Dimensions			Shackle Dimensions (Metric)		
				A	B	C	A	B	C
15SSKADLJ	Keyed Alike; 2-1/2in (64mm) Shackle	—	6	7/16in	2-1/2in	1-3/16in	11mm	64mm	30mm
15SSTLJ	2-Pack of No. 15SSLJ Keyed Alike	—	6	7/16in	2-1/2in	1-3/16in	11mm	64mm	30mm

PLEASE SEE MASTER LOCK COMMERCIAL PRICE BOOK FOR KEYED ALIKE ITEMS

KEY BLANKS: See pages 67-69 for respective key blanks or cut key information.

RETAIL PRODUCTS AVAILABLE ONLY IN MASTER CARTON OR SHELF PACK QUANTITIES.

STAINLESS STEEL PIN TUMBLER PADLOCKS



No.311SSKADLF No.311SSKADLH

- 1-9/16in (40mm) wide laminated steel body design, with a tough weather coated finish for maximum strength and reliability
- Stainless steel shackle and durable finish for improved weather resistance
- Black weather resistant thermoplastic shell provides outdoor protection against moisture, dirt & grime
- Ball bearing locking for maximum pry resistance
- 4-pin tumbler cylinder for increased weather and pick resistance

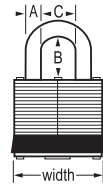

Stainless Steel No. 311 Padlocks

Product Number	Description	Shelf Pack Quantity	Master Carton Quantity	Shackle Dimensions			Shackle Dimensions (Metric)		
				A	B	C	A	B	C
311SSKADLF	Keyed Alike; 1-1/2in (38mm) Shackle	—	6	9/32in	1-1/2in	5/8in	7mm	38mm	16mm
311SSTRILF	3-Pack of No. 311SSLF Keyed Alike	—	6	9/32in	1-1/2in	5/8in	7mm	38mm	16mm
311SSKADLH	Keyed Alike; 2in (51mm) Shackle	—	6	9/32in	2in	5/8in	7mm	51mm	16mm



No.315SSKAD

- 1-9/16in (40mm) wide laminated steel body design, with a tough weather coated finish for maximum strength and reliability
- Stainless steel shackle and durable finish for improved weather resistance
- Yellow weather resistant thermoplastic shell provides outdoor protection against moisture, dirt & grime
- Ball bearing locking for maximum pry resistance
- 4-pin tumbler cylinder for increased weather and pick resistance

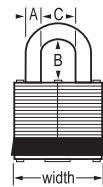

Stainless Steel No. 315 Padlock

Product Number	Description	Shelf Pack Quantity	Master Carton Quantity	Shackle Dimensions			Shackle Dimensions (Metric)		
				A	B	C	A	B	C
315SSKAD	Keyed Alike	—	6	9/32in	3/4in	5/8in	7mm	19mm	16mm

PLEASE SEE MASTER LOCK COMMERCIAL PRICE BOOK FOR KEYED ALIKE ITEMS

KEY BLANKS: See pages 67-69 for respective key blanks or cut key information.

RETAIL PRODUCTS AVAILABLE ONLY IN MASTER CARTON OR SHELF PACK QUANTITIES.

LAMINATED STEEL PIN TUMBLER PADLOCKS



- 1-3/4in (44mm) wide laminated steel body for superior strength
- Hardened steel shackle for extra cut resistance
- Ball bearing locking for maximum pry resistance
- More than 3,000 key changes for maximum pick resistance
- 4-pin tumbler cylinder for increased weather and pick resistance

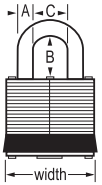

No. 1 Padlocks

Product Number	Description	Shelf Pack Quantity	Master Carton Quantity	Shackle Dimensions			Shackle Dimensions (Metric)		
				A	B	C	A	B	C
1D	Keyed Different	4	24	5/16in	15/16in	3/4in	8mm	24mm	19mm
1DLF	Keyed Different, 1-1/2in (38mm) Shackle	4	24	5/16in	1-1/2in	3/4in	8mm	38mm	19mm
1DLH	Keyed Different; 2in (51mm) Shackle	4	16	5/16in	2in	3/4in	8mm	51mm	19mm
1DLJ	Keyed Different; 2-1/2in (64mm) Shackle	6	24	5/16in	2-1/2in	3/4in	8mm	64mm	19mm
1TLF	2-Pack of No. 1LF Keyed Alike	4	16	5/16in	1-1/2in	3/4in	8mm	38mm	19mm
1TLH	2-Pack of No. 1LH Keyed Alike	4	16	5/16in	2in	3/4in	8mm	51mm	19mm
1TRILJ	3-Pack of No. 1LJ Keyed Alike	4	16	5/16in	2-1/2in	3/4in	8mm	64mm	19mm



- 1-9/16in (40mm) wide laminated steel body for superior strength
- Hardened steel shackle for extra cut resistance
- Ball bearing locking for maximum pry resistance
- More than 3,000 key changes for maximum pick resistance
- 4-pin tumbler cylinder for increased weather and pick resistance

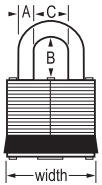

No. 3 Padlocks

Product Number	Description	Shelf Pack Quantity	Master Carton Quantity	Shackle Dimensions			Shackle Dimensions (Metric)		
				A	B	C	A	B	C
3D	Keyed Different	4	24	9/32in	3/4in	5/8in	7mm	19mm	16mm
3DLF	Keyed Different; 1-1/2in (38mm) Shackle	4	24	9/32in	1-1/2in	5/8in	7mm	38mm	16mm
3DLH	Keyed Different; 2in (51mm) Shackle	6	36	9/32in	2in	5/8in	7mm	51mm	16mm
3T	2-Pack of No. 3 Keyed Alike	4	16	9/32in	3/4in	5/8in	7mm	19mm	16mm
3TRILF	3-Pack of No. 3LF Keyed Alike	4	24	9/32in	1-1/2in	5/8in	7mm	38mm	16mm
3008D	4-Pack of No. 3 Keyed Alike	4	16	9/32in	3/4in	5/8in	7mm	19mm	16mm
3QLF	4-Pack of No. 3LF Keyed Alike	4	16	9/32in	1-1/2in	5/8in	7mm	38mm	16mm

PLEASE SEE MASTER LOCK COMMERCIAL PRICE BOOK FOR KEYED ALIKE ITEMS

KEY BLANKS: See pages 67-69 for respective key blanks or cut key information.

RETAIL PRODUCTS AVAILABLE ONLY IN MASTER CARTON OR SHELF PACK QUANTITIES.

LAMINATED STEEL PIN TUMBLER PADLOCKS



- 2in (51mm) wide laminated steel body for superior strength
- Hardened boron alloy shackle for superior cut resistance
- Ball bearing locking for maximum pry resistance
- 4-pin tumbler cylinder for increased weather and pick resistance
- More than 3,000 key changes for maximum pick resistance

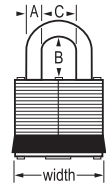

No. 5 Padlocks

Product Number	Description	Shelf Pack Quantity	Master Carton Quantity	Shackle Dimensions			Shackle Dimensions (Metric)		
				A	B	C	A	B	C
5D	Keyed Different	4	24	3/8in	1in	15/16in	10mm	25mm	24mm
5DLJ	Keyed Different; 2-1/2in (64mm) Shackle	4	16	3/8in	2-1/2in	15/16in	10mm	64mm	24mm
5T	2-Pack of No. 5 Keyed Alike	6	24	3/8in	1in	15/16in	10mm	25mm	24mm
5TLF	2-Pack of No. 5LF Keyed Alike	4	16	3/8in	1-1/2in	15/16in	10mm	38mm	24mm
5TRILFPF	3-Pack of No. 5LF Keyed Alike	4	16	3/8in	1-1/2in	15/16in	10mm	38mm	24mm
5TRILJ	3-Pack of No. 5LJ Keyed Alike	4	16	3/8in	2-1/2in	15/16in	10mm	64mm	24mm



- 1-1/8in (29mm) wide laminated steel body for superior strength
- Standard steel shackle
- 4-pin cylinder helps prevent picking
- Minimal clearance helps prevent prying
- More than 1,500 key changes for maximum pick resistance

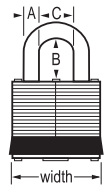

No. 7 Padlock

Product Number	Description	Shelf Pack Quantity	Master Carton Quantity	Shackle Dimensions			Shackle Dimensions (Metric)		
				A	B	C	A	B	C
7D	Keyed Different	4	24	3/16in	9/16in	1/2in	5mm	14mm	13mm

PLEASE SEE MASTER LOCK COMMERCIAL PRICE BOOK FOR KEYED ALIKE ITEMS

KEY BLANKS: See pages 67-69 for respective key blanks or cut key information.

RETAIL PRODUCTS AVAILABLE ONLY IN MASTER CARTON OR SHELF PACK QUANTITIES.

WEATHER RESISTANT LAMINATED STEEL PIN TUMBLER PADLOCKS



No. 311D No. 312D No. 312DLH

- Outdoor protection against moisture, dirt & grime
- High-tech thermoplastic shell designed to withstand the elements
- 1-9/16in (40mm) wide laminated steel body for superior strength
- Ball bearing locking for maximum pry resistance
- Hardened steel shackle for extra cut resistance
- Ideal for all outdoor applications

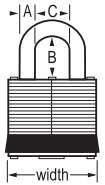

Nos. 311 and 312 Padlocks

Product Number	Description	Shelf Pack Quantity	Master Carton Quantity	Shackle Dimensions			Shackle Dimensions (Metric)		
				A	B	C	A	B	C
311D	Keyed Different; Black Cover	4	24	9/32in	1-1/16in	5/8in	7mm	27mm	16mm
311TRI	3-Pack of No. 311 Keyed Alike	4	16	9/32in	1-1/16in	5/8in	7mm	27mm	16mm
312D	Keyed Different; Blue Cover	4	24	9/32in	1-1/16in	5/8in	7mm	27mm	16mm
312DLH	Keyed Different; 2in (51mm) Shackle	4	24	9/32in	2in	5/8in	7mm	51mm	16mm
312TRI	3-Pack of No. 312 Keyed Alike	4	16	9/32in	1-1/16in	5/8in	7mm	27mm	16mm



No. 317DSPT

- Camouflaged for maximum concealment
- 1-9/16in (40mm) wide laminated steel body for superior strength
- Hardened steel shackle for extra cut resistance
- Ball bearing locking for maximum pry resistance
- 4-pin tumbler cylinder for increased weather and pick resistance
- High-tech thermoplastic shell designed to withstand the elements

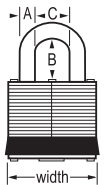

No. 317 Padlock

Product Number	Description	Shelf Pack Quantity	Master Carton Quantity	Shackle Dimensions			Shackle Dimensions (Metric)		
				A	B	C	A	B	C
317DSPT	Keyed Different; Camouflage Cover	4	24	3/8in	1in	1/2in	10mm	25mm	13mm

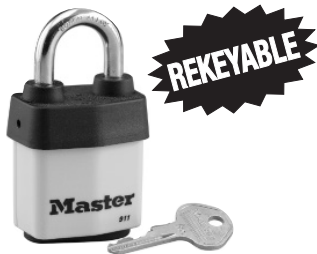

No. 911DPF

- Designed to meet the needs of contractors and small businesses
- 2-1/8in (54mm) wide reinforced laminated steel body
- Weatherproof cover and keyway protection
- Hardened boron alloy shackle for maximum cut resistance
- 5-pin cylinder helps prevent picking
- Removable cylinder can be replaced or repinned
- Ball bearing locking for maximum pry resistance
- FlexFit™ keyway cover minimizes jamming
- Ideal for outdoor applications

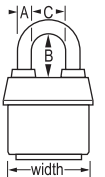

No. 911 Padlock

Product Number	Description	Shelf Pack Quantity	Master Carton Quantity	Shackle Dimensions			Shackle Dimensions (Metric)		
				A	B	C	A	B	C
911DPF	Keyed Different	4	24	5/16in	1-1/8in	7/8in	8mm	29mm	22mm

PLEASE SEE MASTER LOCK COMMERCIAL PRICE BOOK FOR KEYED ALIKE ITEMS

KEY BLANKS: See pages 67-69 for respective key blanks or cut key information.

RETAIL PRODUCTS AVAILABLE ONLY IN MASTER CARTON OR SHELF PACK QUANTITIES.

LAMINATED BRASS PIN TUMBLER PADLOCK



No. 4D

- Brass construction offers maximum corrosion resistance
- Hardened steel shackle for extra cut resistance
- Ball bearing locking for maximum pry resistance
- 4-pin tumbler cylinder for increased weather and pick resistance
- Ideal for marine and other harsh environments

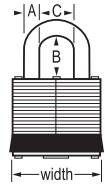

No. 4 Padlock

Product Number	Description	Shelf Pack Quantity	Master Carton Quantity	Shackle Dimensions			Shackle Dimensions (Metric)		
				A	B	C	A	B	C
1-9/16in (40mm) wide									
4D	Keyed Different	6	36	9/32in	3/4in	5/8in	7mm	19mm	16mm

RUST-OLEUM® CERTIFIED PADLOCKS



No. 380D

- Rust-Oleum® certified finish for lifetime rust protection on lock body
- 1-9/16in (40mm) wide laminated steel body for superior strength
- Hardened steel shackle for extra cut resistance
- 1-1/8in (29mm) shackle for additional clearance
- Ball bearing locking for maximum pry resistance
- 4-pin tumbler cylinder for increased weather and pick resistance

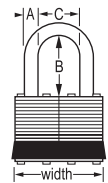

No. 380 Padlocks

Product Number	Description	Shelf Pack Quantity	Master Carton Quantity	Shackle Dimensions			Shackle Dimensions (Metric)		
				A	B	C	A	B	C
380D	Keyed Different; Silver Finish	4	24	9/32in	1-1/8in	5/8in	7mm	29mm	16mm
380T	2-Pack of No. 380 Keyed Alike; Silver Finish	4	16	9/32in	1-1/8in	5/8in	7mm	29mm	16mm

PLEASE SEE MASTER LOCK COMMERCIAL PRICE BOOK FOR KEYED ALIKE ITEMS

KEY BLANKS: See pages 67-69 for respective key blanks or cut key information.

RETAIL PRODUCTS AVAILABLE ONLY IN MASTER CARTON OR SHELF PACK QUANTITIES.

FUSION™ PADLOCK



- Front access keyway for ease of use
- Shrouded shackle protects against cutting
- Available in multiple colors
- Matching covered key heads for easy identification

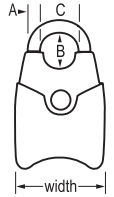

Fusion™ Padlock

Product Number	Description	Shelf Pack Quantity	Master Carton Quantity	Shackle Dimensions			Shackle Dimensions (Metric)		
				A	B	C	A	B	C
1-3/4in (44mm) wide									
192D	Keyed Different; Front Access; Assortment of 4 colors per shelf pack, Red, Blue, Green and Purple	4	24	1/4in	5/8in	3/4in	6mm	18mm	19mm

SHROUDED PADLOCKS

TECHNOLOGY • SECURITY • PERFORMANCE



No. 185D No. 187XD

- Titanium Series™ reinforced for maximum strength
- "Bolt Cutter Tough" and "Crowbar Resistant" hardened steel shrouded shackle offers extreme cut and pry resistance
- Weather Tough® sliding keyway cover keeps dirt and grime from jamming the locking mechanism
- Scratch proof and durable ABS plastic bumper
- Key retaining feature ensures padlock is not left unlocked

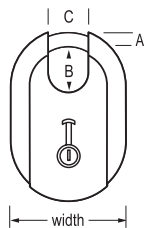

Nos. 185 and 187 Padlocks

Product Number	Description	Shelf Pack Quantity	Master Carton Quantity	Shackle Dimensions			Shackle Dimensions (Metric)		
				A	B	C	A	B	C
1-15/16in (49mm) wide, Black									
185D	Keyed Different	4	24	9/32in	5/8in	5/8in	7mm	16mm	16mm
2-5/16in (59mm) wide, Black									
187XD	Keyed Different	4	24	5/16in	15/16in	3/4in	8mm	24mm	19mm

PLEASE SEE MASTER LOCK COMMERCIAL PRICE BOOK FOR KEYED ALIKE ITEMS

KEY BLANKS: See pages 67-69 for respective key blanks or cut key information.

RETAIL PRODUCTS AVAILABLE ONLY IN MASTER CARTON OR SHELF PACK QUANTITIES.

SHROUDED PADLOCKS



No. 40DPF

- Fully shrouded design minimizes shackle exposure and protects against bolt cutter attacks
- Key retaining feature ensures padlock is not left unlocked
- 2-3/4in (70mm) wide stainless steel body resists corrosion
- Hardened steel shackle for extra cut resistance
- 4-pin cylinder helps prevent picking
- Double deadbolt locking to guard against pulling

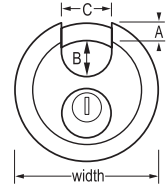

No. 40 Padlocks

Product Number	Description	Shelf Pack Quantity	Master Carton Quantity	Shackle Dimensions			Shackle Dimensions (Metric)		
				A	B	C	A	B	C
40KADPF	Keyed Alike	6	36	3/8in	5/8in	3/4in	10mm	16mm	19mm
40DPF	Keyed Different	4	24	3/8in	5/8in	3/4in	10mm	16mm	19mm
40T	2-Pack of No. 40 Keyed Alike	4	16	3/8in	5/8in	3/4in	10mm	16mm	19mm
40TRI	3-Pack of No. 40 Keyed Alike	4	16	3/8in	5/8in	3/4in	10mm	16mm	19mm

NOTE: WHEN ORDERING KEYED ALIKE PADLOCKS, EACH DIFFERENT KEYED ALIKE SET IS A SEPARATE LINE ITEM.



No. 1DEX

No. 3DEX

- EXtra security, EXtra strong
- Fully shrouded body for additional pry and cut resistance
- Laminated steel body for superior strength
- Hardened steel shackle for extra cut resistance
- 4-pin cylinder helps prevent picking

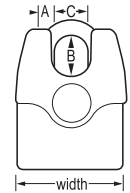

EX Series™ Padlocks

Product Number	Description	Shelf Pack Quantity	Master Carton Quantity	Shackle Dimensions			Shackle Dimensions (Metric)		
				A	B	C	A	B	C
1DEX	Keyed Different; 1-3/4in (44mm) wide body	4	24	5/16in	13/16in	25/32in	8mm	21mm	20mm
3DEX	Keyed Different; 1-9/16in (40mm) wide body	4	24	9/32in	3/4in	5/8in	7mm	19mm	16mm



No. 37D

- Armored hardened steel shackle defies cutting
- 1-9/16in (40mm) wide laminated steel body for superior strength
- 4-pin cylinder helps prevent picking
- Shackle guard protects against bolt cutters and hacksaws
- Ideal for securing trailers, cables and chains
- Shackle fits openings 1/2in (13mm) in diameter or larger; shackle guard removable to accommodate openings 9/32in (7mm) in diameter

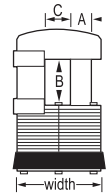

No. 37 Padlock

Product Number	Description	Shelf Pack Quantity	Master Carton Quantity	Shackle Dimensions			Shackle Dimensions (Metric)		
				A	B	C	A	B	C
37D	Keyed Different	4	24	*	15/16in	7/16in	*	24mm	11mm

PLEASE SEE MASTER LOCK COMMERCIAL PRICE BOOK FOR KEYED ALIKE ITEMS

KEY BLANKS: See pages 67-69 for respective key blanks or cut key information.

RETAIL PRODUCTS AVAILABLE ONLY IN MASTER CARTON OR SHELF PACK QUANTITIES.

SOLID BRASS PADLOCKS



- Stylish and strong solid brass lock body
- Standard steel and hardened steel shackles available
- 3-pin, 4-pin and 5-pin cylinders available

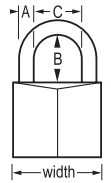

Nos. 120, 130, 140, 150 and 160 Padlocks

Product Number	Description	Shelf Pack Quantity	Master Carton Quantity	Shackle Dimensions			Shackle Dimensions (Metric)		
				A	B	C	A	B	C
3/4in (19mm) wide, Solid Body with Standard Steel Shackle, 3-pin Tumbler Security									
120KAD	Keyed Alike	6	72	5/32in	7/16in	3/8in	4mm	11mm	10mm
120D	Keyed Different	4	24	5/32in	7/16in	3/8in	4mm	11mm	10mm
120T	2-Pack of No. 120 Keyed Alike	4	24	5/32in	7/16in	3/8in	4mm	11mm	10mm
120Q	4-Pack of No. 120 Keyed Alike	4	16	5/32in	7/16in	3/8in	4mm	11mm	10mm
1-3/16in (30mm) wide, Solid Body with Hardened Steel Shackle, 4-pin Tumbler Security									
130KAD	Keyed Alike	6	36	3/16in	5/8in	9/16in	5mm	16mm	14mm
130D	Keyed Different	4	24	3/16in	5/8in	9/16in	5mm	16mm	14mm
1-9/16in (40mm) wide, Solid Body with Hardened Steel Shackle, 4-pin Tumbler Security									
140KAD	Keyed Alike	6	36	1/4in	7/8in	13/16in	6mm	22mm	21mm
140D	Keyed Different	4	24	1/4in	7/8in	13/16in	6mm	22mm	21mm
140DLF	Keyed Different; 1-1/2in (38mm) Shackle	6	36	1/4in	1-1/2in	13/16in	6mm	38mm	21mm
140DLH	Keyed Different; 2in (51mm) Shackle	6	36	1/4in	2in	13/16in	6mm	51mm	21mm
140T	2-Pack of No. 140 Keyed Alike	6	24	1/4in	7/8in	13/16in	6mm	22mm	21mm
140Q	4-Pack of No. 140 Keyed Alike	4	16	1/4in	7/8in	13/16in	6mm	22mm	21mm
140QLH	4-Pack of No. 140LH Keyed Alike	4	16	1/4in	2in	13/16in	6mm	51mm	21mm
2in (50mm) wide, Solid Body with Hardened Steel Shackle, 5-pin Tumbler Security									
150D	Keyed Different	4	24	9/32in	1in	1in	7mm	25mm	25mm
2-3/8in (60mm) wide, Solid Body with Hardened Steel Shackle, 5-pin Tumbler Security									
160D	Keyed Different	4	24	11/32in	1-1/8in	1-1/4in	9mm	29mm	32mm

NOTE: WHEN ORDERING KEYED ALIKE PADLOCKS, EACH DIFFERENT KEYED ALIKE SET IS A SEPARATE LINE ITEM.



No. 576DLHPF No. 575DPF

- Solid brass body is strong, durable and resists corrosion
- Ball bearing locking for maximum pry resistance
- Hardened steel shackle for extra cut resistance
- 5-pin cylinder for maximum pick resistance

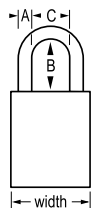

Nos. 575 and 576 Padlocks

Product Number	Description	Shelf Pack Quantity	Master Carton Quantity	Shackle Dimensions			Shackle Dimensions (Metric)		
				A	B	C	A	B	C
1-1/2in (38mm) wide									
575DPF	Keyed Different	4	24	9/32in	15/16in	3/4in	7mm	25mm	19mm
1-3/4in (44mm) wide									
576DLHPF	Keyed Different; 2in (51mm) Shackle	4	24	5/16in	2in	13/16in	8mm	51mm	21mm

PLEASE SEE MASTER LOCK COMMERCIAL PRICE BOOK FOR KEYED ALIKE ITEMS

KEY BLANKS: See pages 67-69 for respective key blanks or cut key information.

RETAIL PRODUCTS AVAILABLE ONLY IN MASTER CARTON OR SHELF PACK QUANTITIES.

COVERED SOLID BODY PADLOCKS



- Stylish scratch resistant vinyl covered padlocks
- Made of corrosion resistant materials
- Standard steel and hardened steel shackles available
- Matching colored key head for added convenience

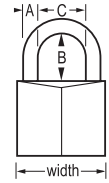

Solid Body Nos. 121, 131, 132, 136, 141, 142 and 146 Padlocks

Product Number	Description	Shelf Pack Quantity	Master Carton Quantity	Shackle Dimensions			Shackle Dimensions (Metric)		
				A	B	C	A	B	C
3/4in (19mm) wide, Covered Body, Steel Shackle, 3-pin Tumbler Security									
121T	2-Pack of No. 121 Keyed Alike; Black Cover	4	24	5/32in	7/16in	1/4in	4mm	11mm	6mm
1-3/16in (30mm) wide, Covered Body, Hardened Steel Shackle, 4-pin Tumbler Security									
131D	Keyed Different; Black Cover	4	24	3/16in	5/8in	9/16in	5mm	16mm	14mm
131T	2-Pack of No. 131 Keyed Alike; Black Cover	4	16	3/16in	5/8in	9/16in	5mm	16mm	14mm
131Q	4-Pack of No. 131 Keyed Alike; Black Cover	4	16	3/16in	5/8in	9/16in	5mm	16mm	14mm
132DCM	Keyed Different; Blue Cover	4	24	3/16in	5/8in	9/16in	5mm	16mm	14mm
136T	2-Pack of No. 136 Keyed Alike; Pink Cover	4	16	3/16in	5/8in	9/16in	5mm	16mm	14mm
1-9/16in (40mm) wide, Covered Body, Hardened Steel Shackle, 4-pin Tumbler Security									
141D	Keyed Different; Black Cover	4	24	1/4in	7/8in	13/16in	6mm	22mm	21mm
141DLF	Keyed Different; Black Cover; 1-1/2in (38mm) Shackle	4	24	1/4in	1-1/2in	13/16in	6mm	38mm	21mm
141T	2-Pack of No. 141 Keyed Alike; Black Cover	4	16	1/4in	7/8in	13/16in	6mm	22mm	21mm
141TRILF	3-Pack of No. 141LF Keyed Alike; Black Cover 1-1/2in (38mm) Shackle	4	16	1/4in	1-1/2in	13/16in	6mm	38mm	21mm
142DCM	Keyed Different; Blue Cover	4	24	1/4in	7/8in	13/16in	6mm	22mm	21mm
146D	Keyed Different; Pink Cover	4	24	1/4in	7/8in	13/16in	6mm	22mm	21mm



No. 527D

- 2in (51mm) covered solid body
- Removable adjustable shackle provides maximum application flexibility
- Covered shackle and body protect surfaces
- Adjustable shackle ensures snug fit to locked items

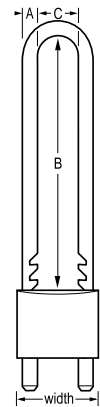

No. 527 Padlock

Product Number	Description	Shelf Pack Quantity	Master Carton Quantity	Shackle Dimensions			Shackle Dimensions (Metric)		
				A	B	C	A	B	C
527D	Keyed Different	4	24	5/16in	2-3/8-5-15/16in	1-1/32in	8mm	6cm-15cm	27mm

PLEASE SEE MASTER LOCK COMMERCIAL PRICE BOOK FOR KEYED ALIKE ITEMS

KEY BLANKS: See pages 67-69 for respective key blanks or cut key information.

RETAIL PRODUCTS AVAILABLE ONLY IN MASTER CARTON OR SHELF PACK QUANTITIES.

CHROME STEEL PADLOCKS



No. 532DPFSEN

- Chrome plated solid steel body is strong, durable and resists rust and corrosion
- Ball bearing locking for maximum pry resistance
- Hardened steel shackle for added protection from cutting and sawing
- 5-pin cylinder for maximum pick resistance

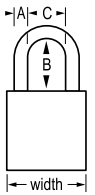

No. 532 Padlock

Product Number	Description	Shelf Pack Quantity	Master Carton Quantity	Shackle Dimensions			Shackle Dimensions (Metric)		
				A	B	C	A	B	C
2in (51mm) wide									
532DPFSEN	Keyed Different	4	24	3/8in	1-1/4in	1in	10mm	32mm	25mm

DIE-CAST ZINC AND SOLID STEEL PADLOCK



REKEYABLE

No. 930DLHPF

- High security padlock resists tough abuse
- 2-1/2in (64mm) wide solid steel body
- Hardened boron alloy shackle for superior cut resistance
- 5-pin cylinder for maximum pick resistance
- Removable cylinder can be replaced or repinned
- Industrial grade materials to withstand attacks
- More than 9,000 key changes for maximum pick resistance

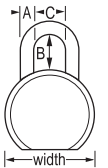

No. 930 Padlocks

Product Number	Description	Shelf Pack Quantity	Master Carton Quantity	Shackle Dimensions			Shackle Dimensions (Metric)		
				A	B	C	A	B	C
930DPF	Keyed Different	4	24	7/16in	1-1/8in	7/8in	11mm	29mm	22mm
930DLHPF	Keyed Different; 2in (51mm) Shackle	4	24	7/16in	2in	7/8in	11mm	51mm	22mm

ALUMINUM PADLOCK



No. 570DLHPF

- Solid aluminum body is lightweight, durable and resists corrosion
- Ball bearing locking for maximum pry resistance
- Hardened steel shackle for added protection from cutting and sawing
- 5-pin cylinder for maximum pick resistance
- Key retaining feature ensures padlock is not left unlocked

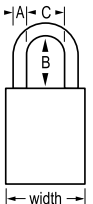

No. 570 Padlock

Product Number	Description	Shelf Pack Quantity	Master Carton Quantity	Shackle Dimensions			Shackle Dimensions (Metric)		
				A	B	C	A	B	C
1-1/2in (38mm) wide									
570DLHPF	Keyed Different; 2in (51mm) Shackle	4	24	9/32in	2in	3/4in	7mm	51mm	19mm

PLEASE SEE MASTER LOCK COMMERCIAL PRICE BOOK FOR KEYED ALIKE ITEMS

KEY BLANKS: See pages 67-69 for respective key blanks or cut key information.

RETAIL PRODUCTS AVAILABLE ONLY IN MASTER CARTON OR SHELF PACK QUANTITIES.

BLUETOOTH PADLOCKS



Master Lock *Bluetooth*® padlocks turn smart devices into a key! True keyless convenience provides greater control and flexibility to share access with friends, family, colleagues and employees. Enjoy peace of mind by monitoring the lock's activity and receive notifications. Available in two models for indoor or outdoor use.



No. 4400D



No. 4401DLH

- No need to worry over lost keys or forgotten combinations!
- Enjoy improved speed and ease of use with free app
- Gain greater flexibility and control—share limited or permanent access with others
- Monitor access history and receive notifications
- Directional keypad allows for backup mechanical access
- Receive low battery notifications on padlock and in app

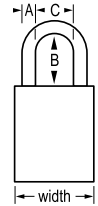

Bluetooth® Padlocks

Product Number	Description	Shelf Pack Quantity	Master Carton Quantity	Shackle Dimensions			Shackle Dimensions (Metric)		
				A	B	C	A	B	C
1-29/32in (47mm) wide									
4400D	Indoor Use Only	2	8	9/32in	7/8in	13/16in	7mm	22mm	20mm
2-7/32in (56mm) wide									
4401DLH	Outdoor Weather Resistance, 2in (51mm) Shackle	2	8	11/32in	2in	15/16in	9mm	51mm	23mm

PLEASE SEE MASTER LOCK COMMERCIAL PRICE BOOK FOR KEYED ALIKE ITEMS

KEY BLANKS: See pages 67-69 for respective key blanks or cut key information.

RETAIL PRODUCTS AVAILABLE ONLY IN MASTER CARTON OR SHELF PACK QUANTITIES.

SET YOUR OWN COMBINATION PADLOCKS



No. 175D



No. 178D

- Set your own combination convenience
- Resetable to allow for a personalized combination
- 4-digit dialing allows for thousands of possible combinations
- 2in (51mm) wide with hardened steel shackle
- Change key included

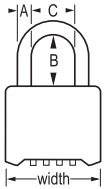

Nos. 175 and 178 Padlocks

Product Number	Description	Shelf Pack Quantity	Master Carton Quantity	Shackle Dimensions			Shackle Dimensions (Metric)		
				A	B	C	A	B	C
175D	Set Your Own Combination	4	24	5/16in	1in	1in	8mm	25mm	25mm
175DWD	Set Your Own Password Combination	4	24	5/16in	1in	1in	8mm	25mm	25mm
175DLH	Set Your Own Combination; 2-1/4in (57mm) Shackle	6	36	5/16in	2-1/4in	1in	8mm	57mm	25mm
175DLHWD	Set Your Own Password Combination; 2-1/4in (57mm) Shackle	4	24	5/16in	2-1/4in	1in	8mm	57mm	25mm
178D	Set Your Own Combination; Black Finish	4	24	5/16in	1in	1in	8mm	25mm	25mm

See page 67 for combination change keys.



No. 875D



No. 875DLH

- Set your own combination with simple shackle rotation; no tool required
- Resetable to allow for a personalized combination
- 4-digit dialing allows for thousands of possible combinations
- 2-5/32in (54mm) wide with hardened steel shackle
- Sealed shackle for increased weather protection

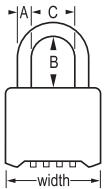

No. 875D Padlocks

Product Number	Description	Shelf Pack Quantity	Master Carton Quantity	Shackle Dimensions			Shackle Dimensions (Metric)		
				A	B	C	A	B	C
875D	Set Your Own Combination	4	24	5/16in	1in	1in	8mm	25m	25mm
875DLH	Set Your Own Combination; 2-1/4in (57mm) Shackle	4	24	5/16in	2-1/4in	1in	8mm	57mm	25mm



No. 653D



- Modern design features high-tech silver finish
- Easy to Set & Reset
- Soft-touch bottom and side grips for no-slip grip
- Durable metal body withstands abuse
- Chrome-plated dials with set your own combination convenience
- Hardened steel shackle for extra cut resistance



No. 653 Padlock

Product Number	Description	Shelf Pack Quantity	Master Carton Quantity	Shackle Dimensions			Shackle Dimensions (Metric)		
				A	B	C	A	B	C
653D	Set Your Own Combination; One each of 4 colors per shelf pack	4	24	1/4in	15/16in	3/4in	6mm	24mm	19mm

PLEASE SEE MASTER LOCK COMMERCIAL PRICE BOOK FOR KEYED ALIKE ITEMS

KEY BLANKS: See pages 67-69 for respective key blanks or cut key information.

RETAIL PRODUCTS AVAILABLE ONLY IN MASTER CARTON OR SHELF PACK QUANTITIES.

SET YOUR OWN COMBINATION PADLOCKS

SPEED DIAL™

- World's first combination lock that opens on up/down/left/right directional movements
- Patented technology is faster, easier and more secure than a standard combination lock
- Maximum security with anti-shim technology
- Combination can be reset to any number of movements in any sequence



No. 1500iD

No. 1500iDPNK

- 2-1/8in (54mm) wide metal body can be opened one-handed without looking for ease of use
- Hardened steel shackle for extra cut resistance



No. 1500iD Speed Dial™ Set Your Own Combination Padlocks

Product Number	Description	Shelf Pack Quantity	Master Carton Quantity	Shackle Dimensions			Shackle Dimensions (Metric)		
				A	B	C	A	B	C
1500iD	Set Your Own Speed Dial™ Combination; One each of 4 colors per shelf pack	4	16	1/4in	1in	3/4in	6mm	25mm	19mm
1500iDPNK	Set Your Own Speed Dial™ Combination; White	4	16	1/4in	1in	3/4in	6mm	25mm	19mm



No. 1590D

- Set your own combination using 3 letters, numbers or a mix of both
- Patented technology operates with right-left-right combination movement
- Combination is easy to change with reset tool included in the package
- Maximum security with anti-shim technology
- 1-15/16in (49mm) wide metal body with hardened steel shackle
- High precision dial "clicks" for accurate dialing

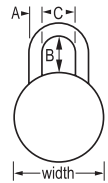

No. 1590 Precision Dial Set Your Own Combination Padlocks

Product Number	Description	Shelf Pack Quantity	Master Carton Quantity	Shackle Dimensions			Shackle Dimensions (Metric)		
				A	B	C	A	B	C
1590D	Set Your Own Combination; One each of 4 dial colors per shelf pack	4	16	1/4in	7/8in	15/16in	6mm	22mm	21mm

PLEASE SEE MASTER LOCK COMMERCIAL PRICE BOOK FOR KEYED ALIKE ITEMS

KEY BLANKS: See pages 67-69 for respective key blanks or cut key information.

RETAIL PRODUCTS AVAILABLE ONLY IN MASTER CARTON OR SHELF PACK QUANTITIES.

SET YOUR OWN COMBINATION PADLOCKS



No. 1534D

- Easy to set & reset - use words, numbers or both!
- 2-1/2in (64mm) wide metal body for superior strength
- Modern, chrome body with bold, colored dials provide a high-tech look
- Special characters & extra dials included to create over 1 million personalized combinations
- Soft touch dials with 2 grip points for no-slip grip
- Hardened steel shackle for extra cut resistance

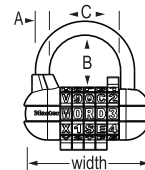

No. 1534 Password Plus™ Set Your Own Combination Padlock

Product Number	Description	Shelf Pack Quantity	Master Carton Quantity	Shackle Dimensions			Shackle Dimensions (Metric)		
				A	B	C	A	B	C
1534D	Set Your Own Combination; One each of 4 dial colors per shelf pack	4	16	1/4in	1-1/8in	1-3/8in	6mm	29mm	35mm



No. 1535D



No. 1535DWD

- Easy to set & reset using coin on bottom of lock
- 1-1/2in (38mm) wide metal body for superior strength
- Slim footprint with ergonomic design
- Multiple dial grip points for accurate dialing
- 10,000 combination possibilities for maximum personalization
- On 1535DWD, choose a memorable word combination
- Hardened steel shackle for extra cut resistance

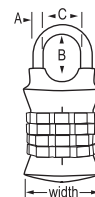

No. 1535 Set Your Own Combination Padlocks

Product Number	Description	Shelf Pack Quantity	Master Carton Quantity	Shackle Dimensions			Shackle Dimensions (Metric)		
				A	B	C	A	B	C
1535D	Set Your Own Combination; One each of 4 dial colors per shelf pack	4	16	1/4in	15/16in	11/16in	6mm	24mm	18mm
1535DWD	Set Your Own Password Combination; One each of 4 dial colors per shelf pack	4	16	1/4in	15/16in	11/16in	6mm	24mm	18mm

PLEASE SEE MASTER LOCK COMMERCIAL PRICE BOOK FOR KEYED ALIKE ITEMS

KEY BLANKS: See pages 67-69 for respective key blanks or cut key information.

RETAIL PRODUCTS AVAILABLE ONLY IN MASTER CARTON OR SHELF PACK QUANTITIES.

COMBINATION PADLOCKS



No. 1500D



No. 1500DCOV

- World's best selling combination lock
- 1-7/8in (48mm) wide durable stainless steel body
- Hardened steel shackle for extra cut resistance
- Combination security for keyless convenience
- 3-digit dialing and 1,500 combinations for maximum security

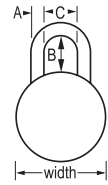

Black Dial Combination Padlocks

Product Number	Description	Shelf Pack Quantity	Master Carton Quantity	Shackle Dimensions			Shackle Dimensions (Metric)		
				A	B	C	A	B	C
1500D	Combination Different	6	24	9/32in	3/4in	13/16in	7mm	19mm	21mm
1500DCOV	Combination Different; Black Bumper	4	24	9/32in	11/16in	13/16in	7mm	17mm	21mm
1500T	2-Pack of No. 1500 Combination Alike	4	16	9/32in	3/4in	13/16in	7mm	19mm	21mm



No. 1503DCOV



No. 1506D

- Bright dial colors make locker identification easy
- 1-7/8in (48mm) wide durable stainless steel body
- Hardened steel shackle for extra cut resistance
- Combination security for keyless convenience
- 3-digit dialing and 1,500 combinations for maximum security

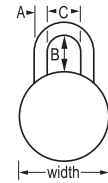

Colored Dial Combination Padlocks

Product Number	Description	Shelf Pack Quantity	Master Carton Quantity	Shackle Dimensions			Shackle Dimensions (Metric)		
				A	B	C	A	B	C
Red Dial									
1504D	Combination Different	4	24	9/32in	3/4in	13/16in	7mm	19mm	21mm
Blue Dial									
1506D	Combination Different	4	24	9/32in	3/4in	13/16in	7mm	19mm	21mm
Dial Assortment									
1505D	Combination Different; Packed one each of 4 dial colors per shelf pack	4	24	9/32in	3/4in	13/16in	7mm	19mm	21mm
1503DCOV	Combination Different; Packed 2 Black, 1 Red, 1 Blue Bumper per shelf pack	4	24	9/32in	11/16in	13/16in	7mm	17mm	21mm



No. 1517D

- Removable adjustable-length shackle provides maximum application flexibility
- Shackle must only be inserted in one direction - see arrow on side of lock
- 1-7/8in (48mm) wide durable stainless steel body
- Vinyl-clad steel shackle helps prevent surface marring
- Combination security for keyless convenience
- 3-digit dialing and 1,500 combinations for maximum security

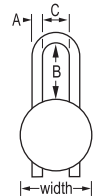

No. 1517 Padlock

Product Number	Description	Shelf Pack Quantity	Master Carton Quantity	Shackle Dimensions			Shackle Dimensions (Metric)		
				A	B	C	A	B	C
1517D	Combination Different	6	48	9/32in	4-1/4- 4-3/4in	13/16- 1-1/16in	7mm	11- 12cm	21- 27mm

PLEASE SEE MASTER LOCK COMMERCIAL PRICE BOOK FOR KEYED ALIKE ITEMS

KEY BLANKS: See pages 67-69 for respective key blanks or cut key information.

RETAIL PRODUCTS AVAILABLE ONLY IN MASTER CARTON OR SHELF PACK QUANTITIES.

COMBINATION PADLOCKS



No. 1530DCM



No. 1561DAST



No. 1530DPNK



No. 1533TRI

- Bright metallic colors make locker identification easy
- 1-7/8in (48mm) wide stainless steel body
- Aluminum cover with durable anodized finish
- Hardened steel shackle for extra cut resistance
- Available in a mini size – 1-9/16in (40mm) wide body in convenient combination-alike multipack

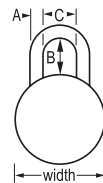

Anodized Combination Padlocks

Product Number	Description	Shelf Pack Quantity	Master Carton Quantity	Shackle Dimensions			Shackle Dimensions (Metric)		
				A	B	C	A	B	C
1530DCM	Combination Different; Assortment of X-treme™ Combination Locks; Packed 4 anodized locks per shelf pack; assortment of colors	4	24	9/32in	3/4in	13/16in	7mm	19mm	21mm
1530DPNK	Combination Different; Pink	4	24	9/32in	3/4in	13/16in	7mm	19mm	21mm
1530T	2-pack; Same Color Combination Alike; Assortment of X-treme™ Combination Locks; Packed 4 anodized locks per shelf pack; assortment of colors	4	16	9/32in	3/4in	13/16in	7mm	19mm	21mm
1533TRI	3-pack; Mini Metallic Combination Alike Locks; 1 each of 3 colors per package; Red, Blue, Purple	4	16	3/16in	11/16in	11/16in	5mm	17mm	17mm
1561DAST	Combination Different; Packed 4 anodized locks with silver dials per shelf pack; assortment of colors.	4	24	9/32in	3/4in	13/16in	7mm	19mm	21mm



No. 1588D

- Ideal for those with visual limitations
- 2-5/32in (55mm) wide zinc body
- Optical grade 360° magnification lens
- Lens design obscures combination from onlookers
- Soft touch outer dial for no-slip grip
- Traditional rotary dial functionality with 3-digit combination



Magnification Combination Padlocks

Product Number	Description	Shelf Pack Quantity	Master Carton Quantity	Shackle Dimensions			Shackle Dimensions (Metric)		
				A	B	C	A	B	C
1588D	Combination lock with magnified lens, shelf pack of assorted colors	4	24	9/32in	7/8in	13/16in	7mm	22mm	21mm
1588T	Combination lock with magnified lens, shelf pack of assorted colors, 2-pk is combination-alike and color-alike in one package	4	16	9/32in	7/8in	13/16in	7mm	22mm	21mm

PLEASE SEE MASTER LOCK COMMERCIAL PRICE BOOK FOR KEYED ALIKE ITEMS

KEY BLANKS: See pages 67-69 for respective key blanks or cut key information.

RETAIL PRODUCTS AVAILABLE ONLY IN MASTER CARTON OR SHELF PACK QUANTITIES.

BACKPACK LOCKS



No. 1547D

- Cool and colorful backpack, luggage, briefcase and computer case protection
- Rugged metal construction
- 3-wheel resettable combination locking mechanism for keyless convenience
- Contemporary colors provide a unique and fun look
- Great for all general-purpose applications at school, at home or in the office

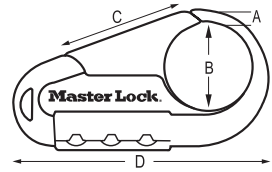

Nos. 1547 and 1548 Backpack Locks

Product Number	Description	Shelf Pack Quantity	Master Carton Quantity	Shackle Dimensions				Shackle Dimensions (Metric)			
				A	B	C	D	A	B	C	D
1547DCM	Set Your Own Combination; Black Case; Chrome Thumbpiece	4	24	3/16in	1-3/16in	1/4in	3-5/16in	5mm	30mm	6mm	84mm
1548DCM	Set Your Own Combination; Assortment packed with 1 each of 4 Reflective Colors per shelf pack; Red, Blue, Green, Purple	4	24	3/16in	1-3/16in	1/4in	3-5/16in	5mm	30mm	6mm	84mm



No. 1550DAST

- 3-wheel resettable combination locking mechanism for keyless convenience
- Innovative design ideal for backpacks, sport bags & luggage
- Protective bumper prevents scratching
- Bright colors for personalization and easy identification

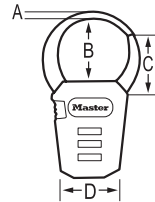

No. 1550 Backpack Lock

Product Number	Description	Shelf Pack Quantity	Master Carton Quantity	Shackle Dimensions				Shackle Dimensions (Metric)			
				A	B	C	D	A	B	C	D
1550DAST	Set Your Own Combination; Assortment of 1 each of 4 colors per shelf pack	4	24	1/8in	1-1/4in	1-1/8in	1-7/8in	3mm	32mm	29mm	48mm

CARABINERS



No. 603D



No. 1273CARSM

- Rugged metal construction is lightweight and durable
- Four vibrant, metallic colors
- Ideal for backpacks, sports bags and key rings
- Not for climbing

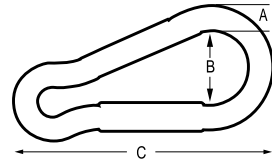

Nos. 603 and 1273 Carabiner Display

Product Number	Description	Shelf Pack Quantity	Master Carton Quantity	Shackle Dimensions			Shackle Dimensions (Metric)		
				A	B	C	A	B	C
603D	3in (76mm) carabiner; Packed 1 Red, 1 Green, 1 Blue, 1 Purple per shelf pack	4	24	5/16in	7/8in	3in	8mm	22mm	76mm
1273CARSM	Carabiner Display; 40 pcs in plastic bin	N/A	1	5/16in	7/8in	3in	8mm	22mm	76mm

PLEASE SEE MASTER LOCK COMMERCIAL PRICE BOOK FOR KEYED ALIKE ITEMS

KEY BLANKS: See pages 67-69 for respective key blanks or cut key information.

RETAIL PRODUCTS AVAILABLE ONLY IN MASTER CARTON OR SHELF PACK QUANTITIES.

LUGGAGE PADLOCKS



No. 620D

No. 630D

No. 643D

- Solid body for style, strength and weatherability
- Chrome plated steel shackle for cut resistance
- Some in bright colors for easy identification
- Set your own combination convenience

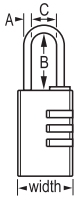

Nos. 620, 630 and 643 Padlocks

Product Number	Description	Shelf Pack Quantity	Master Carton Quantity	Shackle Dimensions			Shackle Dimensions (Metric)		
				A	B	C	A	B	C
13/16in (20mm) wide									
620D	Set Your Own Combination	4	24	1/8in	7/8in	3/8in	3mm	22mm	9mm
620DAST	Set Your Own Combination; Assorted Colors	4	24	1/8in	7/8in	3/8in	3mm	22mm	9mm
1-3/16in (30mm) wide									
630D	Set Your Own Combination	4	24	3/16in	1in	9/16in	5mm	25mm	14mm
630DAST	Set Your Own Combination; Assortment of 4 colors per shelf pack	4	24	3/16in	1in	9/16in	5mm	25mm	14mm
1-9/16in (40mm) wide									
643D	4-dial; Set Your Own Combination	4	24	1/4in	7/8in	1in	6mm	22mm	25mm
643DWD	4-dial; Set Your Own Password Combination	4	24	1/4in	7/8in	1in	6mm	22mm	25mm
643DASTWD	4-dial; Set Your Own Password Combination; Assortment of 4 colors per shelf pack	4	24	1/4in	7/8in	1in	6mm	22mm	25mm



No. 647D

No. 646D

- Durable metal body with upscale black finish
- Steel shackle for cut resistance
- Set your own combination convenience

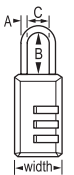

Nos. 646 and 647 Padlocks

Product Number	Description	Shelf Pack Quantity	Master Carton Quantity	Shackle Dimensions			Shackle Dimensions (Metric)		
				A	B	C	A	B	C
13/16in (20mm) wide									
646D	Set Your Own Combination	4	24	1/8in	11/16in	3/8in	3mm	17mm	9mm
646T	2-Pack of No. 646; Set Your Own Combination	4	16	1/8in	11/16in	3/8in	3mm	17mm	9mm
1-3/16in (30mm) wide									
647D	Set Your Own Combination	4	24	3/16in	15/16in	9/16in	5mm	24mm	14mm

PLEASE SEE MASTER LOCK COMMERCIAL PRICE BOOK FOR KEYED ALIKE ITEMS

KEY BLANKS: See pages 67-69 for respective key blanks or cut key information.

RETAIL PRODUCTS AVAILABLE ONLY IN MASTER CARTON OR SHELF PACK QUANTITIES.

TSA-ACCEPTED LUGGAGE PADLOCKS



No. 4681TBLR

- Allows TSA screeners to inspect and relock baggage, without damaging the lock
- Convenient, keyed alike sets ideal for family travel
- 1-1/4in (32mm) wide solid metal body with protective plastic cover
- Available in various colors to simplify luggage identification
- Matching colored keyheads for added convenience



TSA-Accepted Padlocks - Keyed

Product Number	Description	Shelf Pack Quantity	Master Carton Quantity	Shackle Dimensions			Shackle Dimensions (Metric)		
				A	B	C	A	B	C
4681TBLK	TSA-Accepted Keyed Lock with plastic cover; Same color 2-pack; Keyed Alike; Black	4	16	3/32in	9/16in	7/16in	2mm	14mm	11mm
4681TBLR	TSA-Accepted Keyed Lock with plastic cover; 2-pack; Keyed Alike; 2 Blue and 2 Red per shelf pack	4	16	3/32in	9/16in	7/16in	2mm	14mm	11mm



No. 4683Q

- Allows TSA screeners to inspect and relock baggage, without damaging the lock
- Convenient, keyed alike sets ideal for family travel
- 7/8in (22mm) solid metal body

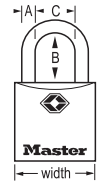

Solid Body TSA-Accepted Padlocks - Keyed

Product Number	Description	Shelf Pack Quantity	Master Carton Quantity	Shackle Dimensions			Shackle Dimensions (Metric)		
				A	B	C	A	B	C
4683Q	TSA-Accepted Keyed Lock; 4-pack; Keyed Alike	4	16	3/32in	7/16in	9/16in	2mm	11mm	14mm



No. 4689Q

- Allows TSA screeners to inspect and relock baggage, without damaging the lock
- 1in (25mm) wide polished chrome upper body, satin metallic lower body
- Popular Master Lock-patented Mini Fusion™ design with convenient front access keyway
- Keyed alike multi-packs are ideal for family travel
- Matching Mini Fusion™-style colored key head
- Bright colors simplify baggage identification

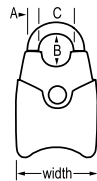

TSA-Accepted Padlocks - Keyed Mini Fusion™

Product Number	Description	Shelf Pack Quantity	Master Carton Quantity	Shackle Dimensions			Shackle Dimensions (Metric)		
				A	B	C	A	B	C
4689T	1in (25mm) Fusion™ Keyed Lock, Blue/Purple/ Pink/Silver shelf pack asst., 2-pack	4	16	1/8in	9/16in	7/16in	3mm	14mm	11mm
4689Q	1in (25mm) Fusion™ Keyed Lock, Blue/Purple/ Pink/Silver shelf pack asst., 4-pack	4	16	1/8in	9/16in	7/16in	3mm	14mm	11mm

PLEASE SEE MASTER LOCK COMMERCIAL PRICE BOOK FOR KEYED ALIKE ITEMS

KEY BLANKS: See pages 67-69 for respective key blanks or cut key information.

RETAIL PRODUCTS AVAILABLE ONLY IN MASTER CARTON OR SHELF PACK QUANTITIES.

TSA-ACCEPTED LUGGAGE PADLOCKS



No. 4680DBLK No. 4680DNKL

- Allows TSA screeners to inspect and relock baggage, without damaging the lock
- 1-3/16in (30mm) wide durable metal body
- 3 dial, set your own combination convenience
- Unique side window for easy combination viewing

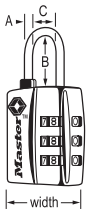

TSA-Accepted Padlocks - Set Your Own Combination

Product Number	Description	Shelf Pack Quantity	Master Carton Quantity	Shackle Dimensions			Shackle Dimensions (Metric)		
				A	B	C	A	B	C
4680DBLK	TSA-Accepted Set Your Own Combination Lock; Black	4	24	1/8in	3/4in	1/2in	3mm	19mm	13mm
4680DNKL	TSA-Accepted Set Your Own Combination Lock; Nickel	4	24	1/8in	3/4in	1/2in	3mm	19mm	13mm



No. 4684T

- Allows TSA screeners to inspect and relock baggage, without damaging the lock
- Bright, neon colors help with luggage identification
- 3 dial, set your own combination convenience
- 2 pack for multiple travel bags
- 1-3/8in (35mm) wide covered metal lock body

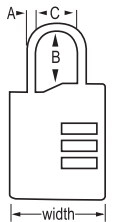

TSA-Accepted Padlocks - High Visibility Set Your Own Combination

Product Number	Description	Shelf Pack Quantity	Master Carton Quantity	Shackle Dimensions			Shackle Dimensions (Metric)		
				A	B	C	A	B	C
4684T	1-3/8in (35mm) Set Your Own Combination Lock in neon green, orange, pink, purple, 2-pack	4	16	1/8in	3/4in	17/32in	4mm	19mm	14mm



No. 4688D

- Allows TSA screeners to inspect and relock baggage, without damaging the lock
- 1-1/8in (29mm) wide metal body with set your own combination convenience
- Unique flexible cable resists abuse from baggage handling equipment
- Matching lock and cable coordinate with popular baggage colors
- Bright colors simplify baggage identification

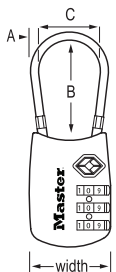

TSA-Accepted Padlocks - Set Your Own Combination with Flexible Shackle

Product Number	Description	Shelf Pack Quantity	Master Carton Quantity	Shackle Dimensions			Shackle Dimensions (Metric)		
				A	B	C	A	B	C
4688D	1-1/8in (29mm) Set Your Own Combination Lock with flexible cable; Blue/Red/Silver/Black	4	24	1/8in	1-1/2in	5/8in	3mm	38mm	15mm
4688T	1-1/8in (29mm) Set Your Own Combination Lock with flexible cable; Blue/Red/Silver/Black, 2-pack	4	16	1/8in	1-1/2in	5/8in	3mm	38mm	15mm

PLEASE SEE MASTER LOCK COMMERCIAL PRICE BOOK FOR KEYED ALIKE ITEMS

KEY BLANKS: See pages 67-69 for respective key blanks or cut key information.

RETAIL PRODUCTS AVAILABLE ONLY IN MASTER CARTON OR SHELF PACK QUANTITIES.

TSA-ACCEPTED LUGGAGE PADLOCKS



No. 4691DWD

- Allows TSA screeners to inspect and relock baggage, without damaging the lock
- 1-3/16in (30mm) wide durable metal body
- 4 dial, set your own password combination convenience
- Unique side window for easy combination viewing

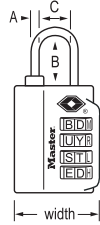

TSA-Accepted Padlocks - Set Your Own Password Combination

Product Number	Description	Shelf Pack Quantity	Master Carton Quantity	Shackle Dimensions			Shackle Dimensions (Metric)		
				A	B	C	A	B	C
4691DWD	TSA-Accepted Set Your Own Password Combination Lock; Assortment of colors	4	24	1/8in	3/4in	1/2in	3mm	19mm	13mm



No. 4692D

- Allows TSA screeners to inspect and relock baggage, without damaging the lock
- Easy to set & reset numeric combination
- 1-1/4in (32mm) wide durable metal body with leatherette cover
- 3 dial combination security for keyless convenience
- Unique side window for easy combination viewing

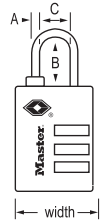

TSA-Accepted Padlocks - No. 4692D

Product Number	Description	Shelf Pack Quantity	Master Carton Quantity	Shackle Dimensions			Shackle Dimensions (Metric)		
				A	B	C	A	B	C
4692D	1-1/4in (32mm) Set Your Own Combination lock with leatherette cover, assortment of colors	4	24	1/8in	3/4in	1/2in	3mm	19mm	13mm



No. 4696D

No. 4696DWD

- Allows TSA screeners to inspect and relock baggage, without damaging the lock
- Easy to set & reset numeric or letter combination
- 1-5/16in (35mm) Wide durable metal body
- 4 dial combination security for keyless convenience
- Extended reach, heavy duty shackle designed for equipment cases
- Unique side window for easy combination viewing
- 10,000 combination possibilities

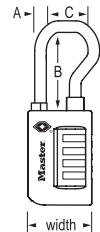

TSA-Accepted Padlocks - No 4696 Extended Reach

Product Number	Description	Shelf Pack Quantity	Master Carton Quantity	Shackle Dimensions			Shackle Dimensions (Metric)		
				A	B	C	A	B	C
4696D	1-5/16in (35mm) resettable combination lock with extended reach shackle, numeric dials, black	4	24	1/4in	1-7/8in	7/8in	6mm	48mm	22mm
4696DWD	1-5/16in (35mm) resettable combination lock with extended reach shackle, letter dials, black	4	24	1/4in	1-7/8in	7/8in	6mm	48mm	22mm
4696T	1-5/16in (35mm) resettable combination lock with extended reach shackle, numeric dials, black, 2-pack	4	16	1/4in	1-7/8in	7/8in	6mm	48mm	22mm
4696TWD	1-5/16in (35mm) resettable combination lock with extended reach shackle, letter dials, black, 2-pack	4	16	1/4in	1-7/8in	7/8in	6mm	48mm	22mm

PLEASE SEE MASTER LOCK COMMERCIAL PRICE BOOK FOR KEYED ALIKE ITEMS

KEY BLANKS: See pages 67-69 for respective key blanks or cut key information.

RETAIL PRODUCTS AVAILABLE ONLY IN MASTER CARTON OR SHELF PACK QUANTITIES.

TSA-ACCEPTED LUGGAGE PADLOCKS



No. 4697D



No. 4697DWD

- Allows TSA screeners to inspect and relock baggage, without damaging the lock
- Unique flexible cable resists abuse from baggage handling equipment
- Easy to set & reset numeric or letter combination
- 1-3/8in (36mm) Wide durable metal body
- 4 dial combination security for keyless convenience
- Colors coordinate with popular baggage colors
- Bright colors simplify baggage identification

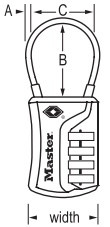

TSA-Accepted Padlocks - No 4697 Soft Touch

Product Number	Description	Shelf Pack Quantity	Master Carton Quantity	Shackle Dimensions			Shackle Dimensions (Metric)		
				A	B	C	A	B	C
4697D	1-3/8in (36mm) soft touch resettable combination lock with flexible cable, numeric dials, blue/red/nickel/pink, shelf pack asst	4	24	1/8in	1-1/2in	1-1/16in	3mm	38mm	27mm
4697DWD	1-3/8in (36mm) soft touch resettable combination lock with flexible cable, letter dials, blue/red/nickel/pink, shelf pack asst	4	24	1/8in	1-1/2in	1-1/16in	3mm	38mm	27mm

PLEASE SEE MASTER LOCK COMMERCIAL PRICE BOOK FOR KEYED ALIKE ITEMS

KEY BLANKS: See pages 67-69 for respective key blanks or cut key information.

RETAIL PRODUCTS AVAILABLE ONLY IN MASTER CARTON OR SHELF PACK QUANTITIES.

PASSWORD PADLOCKS



- Set your own password combination convenience
- Consumers prefer word combinations to number combinations for easier recall
- Bold colors simplify luggage or locker identification

Password Padlocks

Product Number	Description	Shelf Pack Quantity	Master Carton Quantity	Shackle Dimensions			Shackle Dimensions (Metric)		
				A	B	C	A	B	C
1534D	Set Your Own Combination; One each of 4 dial colors per shelf pack	4	16	1/4in	1-1/8in	1-3/8in	6mm	29mm	35mm
1535DWD	Set Your Own Password Combination; One each of 4 dial colors per shelf pack	4	16	1/4in	7/8in	11/16in	6mm	22mm	18mm
1590D	Set Your Own Combination; One each of 4 dial colors per shelf pack	4	16	1/4in	7/8in	15/16in	6mm	22mm	21mm
643DWD	4-dial; Set Your Own Password Combination	4	24	1/4in	7/8in	1in	6mm	22mm	25mm
643DASTWD	4-dial; Set Your Own Password Combination; Assortment of 4 colors per shelf pack	4	24	1/4in	7/8in	1in	6mm	22mm	25mm
4691DWD	TSA-accepted Set Your Own Password Combination Lock; Assortment of colors	4	24	1/8in	3/4in	1/2in	3mm	19mm	13mm
4696DWD	1-5/16in (35mm) resettable combination lock with extended reach shackle, letter dials, black	4	24	1/4in	1-7/8in	7/8in	6mm	48mm	22mm
4696TWD	1-5/16in (35mm) resettable combination lock with extended reach shackle, letter dials, black, 2-pack	4	16	1/4in	1-7/8in	7/8in	6mm	48mm	22mm
4697DWD	1-3/8in (36mm) soft touch resettable combination lock with flexible cable, letter dials, blue/red/nickel/pink, shelf pack asst	4	24	1/8in	1-1/2in	1-1/16in	3mm	38mm	27mm
175DWD	Set Your Own Password Combination	4	24	5/16in	1in	1in	8mm	25mm	25mm
175DLHWD	Set Your Own Password Combination; 2-1/4in (57mm) Shackle	4	24	5/16in	2-1/4in	1in	8mm	57mm	25mm



No. 8220D



No. 8152DASTWD

- Password combination convenience
- Flexible braided steel cable for cut resistance
- Protective coating prevents scratching

Password Cable Locks

Product Number	Description	Shelf Pack Quantity	Master Carton Quantity	Cable Length	Outside Diameter of Cable	Cable Length (Metric)	Outside Diameter of Cable (Metric)
8220D	5-dial Set Your Own Password Combination; 6ft (1.8m), 3/8in (10mm) dia. Braided Steel Cable Lock, includes carrier bracket	4	12	72in (6ft)	3/8in	1.8m	10mm
8152DASTWD	Preset Password Combination; 5ft (1.5m), 1/4in (6mm) dia. Braided Steel Cable Lock	6	24	60in (5ft)	1/4in	1.5m	6mm

PLEASE SEE MASTER LOCK COMMERCIAL PRICE BOOK FOR KEYED ALIKE ITEMS

KEY BLANKS: See pages 67-69 for respective key blanks or cut key information.

RETAIL PRODUCTS AVAILABLE ONLY IN MASTER CARTON OR SHELF PACK QUANTITIES.

WARDER PADLOCKS

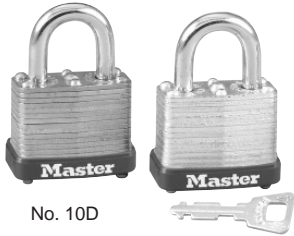

No. 22D

No. 10D

- Laminated steel body
- Steel shackle provides strong cut resistance
- Warded locking mechanism minimizes jamming from dirt and grime
- Duplicate keys not available

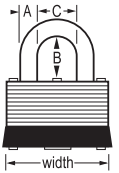

Nos. 10, 22, 105, 500 and 3009 Padlocks

Product Number	Description	Shelf Pack Quantity	Master Carton Quantity	Shackle Dimensions			Shackle Dimensions (Metric)		
				A	B	C	A	B	C
1in (25mm) wide, Laminated Steel Body									
10D	Keyed Different	4	24	5/32in	7/16in	13/32in	4mm	11mm	10mm
1-1/8in (29mm) wide, Laminated Steel Body									
105D	Keyed Different	4	24	3/16in	1/2in	1/2in	5mm	13mm	13mm
1-1/2in (38mm) wide, Laminated Steel Body									
22D	Keyed Different	4	24	1/4in	5/8in	9/16in	6mm	16mm	14mm
22T	2-Pack of No. 22 Keyed Alike	4	16	1/4in	5/8in	9/16in	6mm	16mm	14mm
3009D	4-Pack of No. 22 Keyed Alike	4	16	1/4in	5/8in	9/16in	6mm	16mm	14mm
1-3/4in (44mm) wide, Laminated Steel Body									
500D	Keyed Different	4	24	9/32in	13/16in	13/16in	7mm	21mm	21mm



No. 510D

No. 517D

- Removable adjustable shackles provide maximum application flexibility
- Laminated steel body
- Warded locking mechanism minimizes jamming from dirt and grime
- Adjustable shackle ensures snug fit to the locked item
- Duplicate keys not available

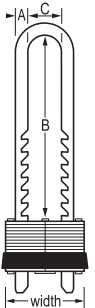

Nos. 510 and 517 Padlocks

Product Number	Description	Shelf Pack Quantity	Master Carton Quantity	Shackle Dimensions			Shackle Dimensions (Metric)		
				A	B	C	A	B	C
1-3/4in (44mm) wide, Warded Laminated Steel Lock with Standard Steel Adjustable Shackle									
510KAD	Keyed Alike	4	24	9/32in	5/8-2in	13/16in	7mm	16-51mm	21mm
510D	Keyed Different	4	24	9/32in	5/8-2in	13/16in	7mm	16-51mm	21mm
517KAD	Keyed Alike	4	24	9/32in	2-3/4-5-3/8in	13/16in	7mm	7-14cm	21mm
517D	Keyed Different	4	24	9/32in	2-3/4-5-3/8in	13/16in	7mm	7-14cm	21mm

PLEASE SEE MASTER LOCK COMMERCIAL PRICE BOOK FOR KEYED ALIKE ITEMS

KEY BLANKS: See pages 67-69 for respective key blanks or cut key information.

RETAIL PRODUCTS AVAILABLE ONLY IN MASTER CARTON OR SHELF PACK QUANTITIES.

GUN LOCKS



No. 90DSPT

- The world standard in trigger lock design
- Steel and zinc body for maximum durability
- 4-pin cylinder helps prevent picking
- Durable metal construction
- Protective rubber pads shield gun from scratching or marring
- Fits many handguns, rifles and shotguns

No. 90 Padlocks

Product Number	Description	Shelf Pack Quantity	Master Carton Quantity
90KADSPT	Keyed Alike	4	24
90DSPT	Keyed Different	4	24
90TRISPT	3-Pack of No. 90 Keyed Alike	4	24

NOTE: WHEN ORDERING KEYED ALIKE PADLOCKS, EACH DIFFERENT KEYED ALIKE SET IS A SEPARATE LINE ITEM.



No. 94DSPT

- Easy to install and set
- Features positive locking with adjustable ratchet mechanism
- Offers added convenience of a keyless resettable combination
- Special cushion pads protect gun's finish from marring or scratching
- Fits many handguns, rifles and shotguns

No. 94 Padlock

Product Number	Description	Shelf Pack Quantity	Master Carton Quantity
94DSPT	Keyless; Set Your Own Combination Trigger Gun Lock	4	24



No. 99DSPT

- 1-5/16in (33mm) laminated steel body for superior strength
- 14in (35cm) steel cable resists cutting
- 4-pin cylinder helps prevent picking
- Dead-locking, anti-rap mechanism defeats physical attacks
- Vinyl covers on lock and cable prevent scratching

No. 99 Cable Locks

Product Number	Description	Shelf Pack Quantity	Master Carton Quantity
99KADSPT	Keyed Alike; Cable Gun Lock	4	24
99DSPT	Keyed Different; Cable Gun Lock	4	24

NOTE: WHEN ORDERING KEYED ALIKE PADLOCKS, EACH DIFFERENT KEYED ALIKE SET IS A SEPARATE LINE ITEM.

PLEASE SEE MASTER LOCK COMMERCIAL PRICE BOOK FOR KEYED ALIKE ITEMS

KEY BLANKS: See pages 67-69 for respective key blanks or cut key information.

RETAIL PRODUCTS AVAILABLE ONLY IN MASTER CARTON OR SHELF PACK QUANTITIES.

GUN LOCKS



No. 107DSPT

- Tested by independent laboratory to stringent AB106 requirements
- Deadbolt locking mechanism can only be opened and closed with key inserted and turned
- 4-pin cylinder helps prevent picking
- 7/32in (5.6mm) dia., 14in (35cm) long armored cable with brass ends prevents scratches
- California Approved

No. 107 Armored Cable Locks

Product Number	Description	Shelf Pack Quantity	Master Carton Quantity
107KADSPT	Keyed Alike; Cable Gun Lock	4	24
107DSPT	Keyed Different; Cable Gun Lock	4	24

NOTE: WHEN ORDERING KEYED ALIKE PADLOCKS, EACH DIFFERENT KEYED ALIKE SET IS A SEPARATE LINE ITEM.

U-LOCKS



No. 8195D

- Disc key for additional anti-pick protection
- Sliding Dust Cover protects keyway from natural elements
- Carrier bracket for storage convenience

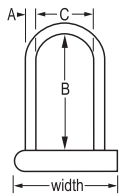

No. 8195 U-Lock

Product Number	Description	Shelf Pack Quantity	Master Carton Quantity	Shackle Dimensions			Shackle Dimensions (Metric)		
				A	B	C	A	B	C
8195D	Keyed Different; 6-5/8in (17cm) wide; U-lock with Carrier bracket	4	12	5/8in	8-1/4in	4-1/4in	16mm	21cm	11cm

PLEASE SEE MASTER LOCK COMMERCIAL PRICE BOOK FOR KEYED ALIKE ITEMS

KEY BLANKS: See pages 67-69 for respective key blanks or cut key information.

RETAIL PRODUCTS AVAILABLE ONLY IN MASTER CARTON OR SHELF PACK QUANTITIES.

U-LOCKS



No. 8118DPF

- Disc key for additional anti-pick protection
- Double locking shackle for maximum pry resistance
- Hardened steel shackle resists cutting and sawing
- Vinyl-covered body and shackle prevents scratching
- Ideal for use with heavy duty cable and chain

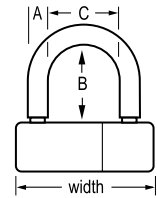

No. 8118 Mini U-Lock

Product Number	Description	Shelf Pack Quantity	Master Carton Quantity	Shackle Dimensions			Shackle Dimensions (Metric)		
				A	B	C	A	B	C
8118DPF	Keyed Different; 3-15/16in (100 mm) x 2in (50mm) wide	4	24	1/2in	2in	1-5/8in	12mm	50mm	42mm



No. 8170D

- Disc key for additional anti-pick protection
- Carrier bracket for storage convenience

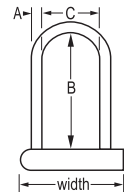

No. 8170 U-Lock

Product Number	Description	Shelf Pack Quantity	Master Carton Quantity	Shackle Dimensions			Shackle Dimensions (Metric)		
				A	B	C	A	B	C
8170D	Keyed Different; 6-1/8in (15cm) wide; U-lock with Carrier bracket	—	6	1/2in	8in	4in	13mm	20cm	10cm



No. 8184D

- Disc key for additional anti-pick protection
- Carrier bracket for storage convenience
- Double locking shackle withstands 3.5 tons (3.2 metric tons) of pull strength

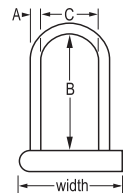

No. 8184 U-Lock

Product Number	Description	Shelf Pack Quantity	Master Carton Quantity	Shackle Dimensions			Shackle Dimensions (Metric)		
				A	B	C	A	B	C
8184D	Keyed Different; 8-1/4in (21cm) wide ATB U-lock with Carrier bracket	4	12	9/16in	9-1/4in	5-1/8in	14mm	24cm	13cm

PLEASE SEE MASTER LOCK COMMERCIAL PRICE BOOK FOR KEYED ALIKE ITEMS

KEY BLANKS: See pages 67-69 for respective key blanks or cut key information.

RETAIL PRODUCTS AVAILABLE ONLY IN MASTER CARTON OR SHELF PACK QUANTITIES.

U-LOCKS



No. 8174D

- 8-1/4in (21cm) wide steel lock body for strength
- Double locking shackle withstands 3.0 tons (2.7 metric tons) of pull strength
- Vinyl-covered body prevents scratching
- Ideal for ladders, generators and gates

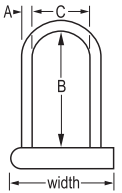

No. 8174 U-Lock

Product Number	Description	Shelf Pack Quantity	Master Carton Quantity	Shackle Dimensions			Shackle Dimensions (Metric)		
				A	B	C	A	B	C
8174DLWPF	Keyed Different	4	12	1/2in	11in	5-1/8in	13mm	28cm	13cm

CHAINS AND CHAIN LOCKS



No. 73D

- Hardened steel and boron alloy chains for maximum cut resistance
- Welded links for superior pry resistance
- Protective vinyl sleeve helps prevent scratching

No. 73 Chain

Product Number	Description	Shelf Pack Quantity	Master Carton Quantity	Chain Length	Outside Diameter of Chain	Chain Length (Metric)	Outside Diameter of Chain (Metric)
Case-hardened Steel Chains							
73D	3ft (0.9m) Chain; Green Sleeve	—	12	36in (3ft)	3/16in	0.9m	5mm

PLEASE SEE MASTER LOCK COMMERCIAL PRICE BOOK FOR KEYED ALIKE ITEMS

KEY BLANKS: See pages 67-69 for respective key blanks or cut key information.

RETAIL PRODUCTS AVAILABLE ONLY IN MASTER CARTON OR SHELF PACK QUANTITIES.

CHAINS AND CHAIN LOCKS



No. 716D

- 1-1/8in (29mm) laminated steel body for superior strength
- Steel shackle for strong cut resistance
- 4-pin cylinder helps prevent picking
- Welded links for superior pry resistance
- Protective red vinyl sleeve helps prevent surface marring
- Lock packaged with chain for consumer convenience

No. 716 Chain Lock

Product Number	Description	Shelf Pack Quantity	Master Carton Quantity	Chain Length	Outside Diameter of Chain	Chain Length (Metric)	Outside Diameter of Chain (Metric)
No. 7 Pin Tumbler Padlock							
716D	Keyed Different	6	48	36in (3ft)	9/64in	0.9m	4mm



No. 8147D

- Integrated barrel combination lock body
- Welded links for superior pry resistance
- Protective vinyl sleeve helps prevent scratching
- Combination security for keyless convenience

No. 8147 Chain Lock

Product Number	Description	Shelf Pack Quantity	Master Carton Quantity	Chain Length	Outside Diameter of Chain	Chain Length (Metric)	Outside Diameter of Chain (Metric)
8147D	Preset Combination; 4ft (1.2m) Chain; Barrel Lock; Red Sleeve	6	48	48in (4ft)	1/8in	1.2m	3mm



No. 8291DPS

- 3ft (90cm) Chain Lock
- Tough square-linked, hardened steel chain resists cutting
- Nylon cover protects equipment
- Disc key for additional anti-pick protection
- Keyway cover keeps lock core clean and dry

No. 8291 Tuff Links® Chain

Product Number	Description	Shelf Pack Quantity	Master Carton Quantity	Chain Length	Outside Diameter of Chain	Chain Length (Metric)	Outside Diameter of Chain (Metric)
8291DPS	Tuff Links® 3ft (90cm) Chain with Integrated Keyed Lock	—	4	3ft	3/8in	.9m	9mm

PLEASE SEE MASTER LOCK COMMERCIAL PRICE BOOK FOR KEYED ALIKE ITEMS

KEY BLANKS: See pages 67-69 for respective key blanks or cut key information.

RETAIL PRODUCTS AVAILABLE ONLY IN MASTER CARTON OR SHELF PACK QUANTITIES.

CABLES AND CABLE LOCKS

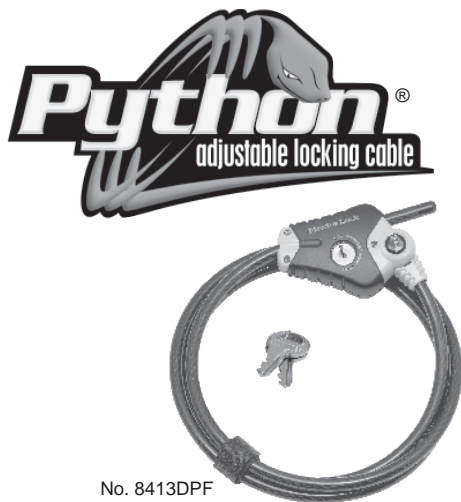

No. 8413DPF

- Patented locking mechanism holds the cable tight at any position from 1ft (30cm) to 6ft (1.8m) for infinite locking positions
- Interchangeable cables for application flexibility
- Rekeyable cylinders for keyed alike convenience
- Available Keyed alike to any standard M1 key cut (see Commercial Boxed Products)
- 3/8in (10mm) braided steel cable
- Weather tough and rust resistant lock body
- Vinyl sleeve and lock body bumper prevents scratching
- Strap holds excess cable for compact storage

Nos. 8413 and 8428 Python® Adjustable Locking Cables

Product Number	Description	Shelf Pack Quantity	Master Carton Quantity	Cable Length	Outside Diameter of Cable	Cable Length (Metric)	Outside Diameter of Cable (Metric)
Yellow Locking Head With Black Bumper							
8413DPF	Keyed Different; 6ft (1.8m) x 3/8in (10mm) Adjustable Locking Cable	—	6	72in (6ft)	3/8in	1.8m	10mm
Silver Locking Head With Black Bumper							
8428DPS	Keyed Different; 6ft (1.8m) x 3/8in (10mm) Adjustable Locking Cable	—	6	72in (6ft)	3/8in	1.8m	10mm

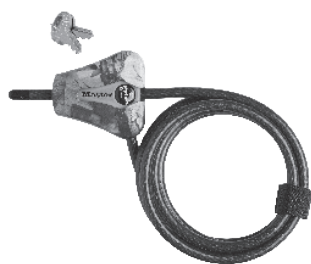

No. 8418KADCAMO



No. 8418D

- Patented locking mechanism holds the cable tight at any length from 6in (15cm) to 6ft (1.8m)
- Cable end threads through places other cables cannot
- 5/16in (8mm) braided steel cable
- Vinyl coated cable and ABS plastic lock body bumper
- Reliable pin tumbler mechanism
- Available with black or Advantage Timber HD® Cover/Bumper

No. 8418 Python® Adjustable Locking Cables

Product Number	Description	Shelf Pack Quantity	Master Carton Quantity	Cable Length	Outside Diameter of Cable	Cable Length (Metric)	Outside Diameter of Cable (Metric)
General Use; Black Body & Bumper							
8418KADCAMO-TMB	Keyed Alike; 6ft (1.8m) x 5/16in (8mm) Adjustable Locking Cable; Camo Cover	—	4	72in (6ft)	5/16in	1.8m	8mm
8418D	Keyed Different; 6ft (1.8m) x 5/16in (8mm) Adjustable Locking Cable	—	4	72in (6ft)	5/16in	1.8m	8mm

PLEASE SEE MASTER LOCK COMMERCIAL PRICE BOOK FOR KEYED ALIKE ITEMS

KEY BLANKS: See pages 67-69 for respective key blanks or cut key information.

RETAIL PRODUCTS AVAILABLE ONLY IN MASTER CARTON OR SHELF PACK QUANTITIES.

CABLES AND CABLE LOCKS



No. 8419DPF

- Patented locking mechanism holds the cable tight at any length from 6in (15cm) to 6ft (1.8m)
- Cable end threads through places other cables cannot
- 5/16in (8mm) braided steel cable
- Vinyl coated cable and ABS plastic lock body bumper
- Reliable pin tumbler mechanism
- Yellow and black contractor color scheme

No. 8419 Python® Adjustable Locking Cable

Product Number	Description	Shelf Pack Quantity	Master Carton Quantity	Cable Length	Outside Diameter of Cable	Cable Length (Metric)	Outside Diameter of Cable (Metric)
8419DPF	Keyed Different; 6ft (1.8m) x 5/16in (8mm) Adjustable Locking Cable	—	4	72in (6ft)	5/16in	1.8m	8mm



No. 8417D

- 3/16in (5mm) x 6ft (1.8m) adjustable steel cable
- Reliable pin tumbler mechanism
- Scratch resistant; vinyl coated cable and ABS lock body cover/bumper
- Compact for portability
- Strap holds excess cable for compact storage

No. 8417 Python® Adjustable Locking Cable

Product Number	Description	Shelf Pack Quantity	Master Carton Quantity	Cable Length	Outside Diameter of Cable	Cable Length (Metric)	Outside Diameter of Cable (Metric)
8417D	Keyed Different; 6ft (1.8m) x 3/16in (5mm) Adjustable Locking Cable	—	6	72in (6ft)	3/16in	1.8m	5mm



No. 8154DPF

- Ideal for bicycles, ladders, generators, toolboxes and gates
- Integrated keyed locking mechanisms for strong pick resistance
- Flexible steel cables for strong cut resistance
- Protective coating helps prevent scratching
- Smoke colored cables with black lock body connectors

Keyed Cable Locks

Product Number	Description	Shelf Pack Quantity	Master Carton Quantity	Cable Length	Outside Diameter of Cable	Cable Length (Metric)	Outside Diameter of Cable (Metric)
8109D	Keyed Different; 5ft (1.5m), 5/16in (8mm) dia. Cable Lock	2	12	60in (5ft)	5/16in	1.5m	8mm
8126D	Keyed Different; 6ft (1.8m), 5/16in (8mm) dia. Self-Coiling Braided Steel Cable Lock	4	12	72in (6ft)	5/16in	1.8m	8mm
8127TRI	Keyed Alike; Colored Locking Cables 6ft (1.8m), 5/16in (8mm) Three Pack includes Red, Green and Blue	—	4	72in (6ft)	5/16in	1.8m	8mm
8154DPF	Keyed Different; 6ft (1.8m), 3/8in (10mm) dia. Smoke Cable with 5-pin cylinder	4	16	72in (6ft)	3/8in	1.8m	10mm

PLEASE SEE MASTER LOCK COMMERCIAL PRICE BOOK FOR KEYED ALIKE ITEMS

KEY BLANKS: See pages 67-69 for respective key blanks or cut key information.

RETAIL PRODUCTS AVAILABLE ONLY IN MASTER CARTON OR SHELF PACK QUANTITIES.

CABLES AND CABLE LOCKS



No. 8155DCC

- Increased cable diameter for maximum performance
- Ideal for bicycles, ladders, generators, toolboxes and gates
- Integrated keyed locking mechanisms for strong pick resistance
- Flexible steel cables for strong cut resistance
- Protective coating helps prevent scratching

No. 8155 Heavy Duty Keyed Cable Lock

Product Number	Description	Shelf Pack Quantity	Master Carton Quantity	Cable Length	Outside Diameter of Cable	Cable Length (Metric)	Outside Diameter of Cable (Metric)
8155DCC	Keyed Different with 5-pin cylinder; 6ft (1.8m), 5/8in (16mm) dia. Cable Lock	—	4	72in (6ft)	5/8in	1.8m	16mm



No. 8218DPS

- Braided steel cable resists cutting and sawing
- High security anti-pick lock cylinder
- Protective coating helps prevent scratching
- No. 8218DPS has a hardened steel sleeve over the braided cable

Cable Locks

Product Number	Description	Shelf Pack Quantity	Master Carton Quantity	Cable Length	Outside Diameter of Cable	Cable Length (Metric)	Outside Diameter of Cable (Metric)
8218DPS	Keyed Different Armored Cable Lock; 6ft (1.8m) x 1-3/16in (30mm)	4	12	72in (6ft)	1-3/16in	1.8m	30mm
8157DPS	Keyed Different Cable Lock; 6ft (1.8m) x 9/16in (15mm)	—	4	72in (6ft)	9/16in	1.8m	15mm

PLEASE SEE MASTER LOCK COMMERCIAL PRICE BOOK FOR KEYED ALIKE ITEMS

KEY BLANKS: See pages 67-69 for respective key blanks or cut key information.

RETAIL PRODUCTS AVAILABLE ONLY IN MASTER CARTON OR SHELF PACK QUANTITIES.

CABLES AND CABLE LOCKS



No. 8119DPF



No. 8143D



No. 8143DPNK

- Ideal for bicycles, ladders, generators, toolboxes and gates
- Combination locking mechanisms for keyless convenience
- Flexible steel cables for strong cut resistance
- Protective coating helps prevent scratching
- Features resettable combination
- Nos. 8122D and 8220D includes carrier bracket for easy transportation

Combination Cable Locks

Product Number	Description	Shelf Pack Quantity	Master Carton Quantity	Cable Length	Outside Diameter of Cable	Cable Length (Metric)	Outside Diameter of Cable (Metric)
Integrated Set Your Own Combination Barrel Lock							
8114D	Set Your Own Combination; 6ft (1.8m), 5/16in (8mm) dia. Cable Lock	4	12	72in (6ft)	5/16in	1.8m	8mm
8119DPF	Set Your Own Combination; 5ft (1.5m), 3/8in (10mm) dia. Cable Lock	4	16	60in (5ft)	3/8in	1.5m	10mm
8122D	Set Your Own Combination; 6ft (1.8m), 1/2in (12mm) dia. Self-Coiling Cable Lock; Includes carrier bracket	4	12	72in (6ft)	1/2in	1.8m	12mm
8220D	5-Dial Set Your Own Password Combination; 6ft (1.8m), 3/8in (10mm) dia. Braided Steel Cable Lock; Includes carrier bracket	4	12	72in (6ft)	3/8in	1.8m	10mm
Compact Cable Lock							
8143D	Preset Combination; 4ft (1.2m), 5/16in (8mm) dia. Self-Coiling Cable Lock	6	24	48in (4ft)	5/16in	1.2m	8mm
8152DASTWD	Preset Password Combination 5ft (1.5m), 1/4in (6mm) dia. Braided Steel Cable Lock	6	24	60in (5ft)	1/4in	1.5m	6mm



No. 4603D



No. 4605D

- Set your own combination for personalization and easy recall
- Cable retracts for a snug fit
- Vinyl coating helps prevent scratching
- Cable recoils easily with push button mechanism



Nos. 4603 and 4605 Retractable Cable Locks

Product Number	Description	Shelf Pack Quantity	Master Carton Quantity	Body Height	Body Width	Cable Length
4603D	Set Your Own Combination; 24in (61cm) x 1/16in (2mm) diameter; Retractable Cable Lock; Packed 1 each of Red, Blue, Green and Clear	4	24	3-1/16in (78mm)	2-1/8in (54mm)	2-24in (5-61cm)
4605D	Set Your Own Combination; 36in (90cm) x 3/32in (2.4mm) diameter; Retractable Cable Lock; Packed 1 each of Red, Blue, Green and Clear	4	24	3-3/4in (95mm)	2-1/2in (64mm)	2-18in (5-48cm)

PLEASE SEE MASTER LOCK COMMERCIAL PRICE BOOK FOR KEYED ALIKE ITEMS

KEY BLANKS: See pages 67-69 for respective key blanks or cut key information.

RETAIL PRODUCTS AVAILABLE ONLY IN MASTER CARTON OR SHELF PACK QUANTITIES.

CABLES AND CABLE LOCKS



No. 72DPF

- Braided steel wires for strength and flexibility
- Convenient loops with rust-resistant sleeves and scratch guards
- Galvanized steel cable resists rusting
- Smoke vinyl coating helps prevent scratching
- Recommend use with laminated locks, solid steel locks and mini U-locks

Heavy Duty Cables

Product Number	Description	Shelf Pack Quantity	Master Carton Quantity	Coated Cable Length	Outside Diameter of Coated Cable	Coated Cable Length (Metric)	Outside Diameter of Coated Cable (Metric)
72DPF	15ft (4.6m), 3/8in (10mm) dia. Cable	—	4	180in (15ft)	3/8in	4.6m	10mm
78DPF	6ft (1.8m), 3/8in (10mm) dia. Cable	4	16	72in (6ft)	3/8in	1.8m	10mm
85DPF	4ft (1.2m), 3/8in (10mm) dia. Cable	4	16	48in (4ft)	3/8in	1.2m	10mm



No. 65D



No. 67D

- Woven steel cables for strong cut resistance
- Strong loops for use with Master Lock padlocks
- Protective coating helps prevent scratching
- Flexibility for convenience
- Self-coiling for storage convenience

General Use Cables

Product Number	Description	Shelf Pack Quantity	Master Carton Quantity	Coated Cable Length	Outside Diameter of Coated Cable	Coated Cable Length (Metric)	Outside Diameter of Coated Cable (Metric)
65D	6ft (1.8m) Self-coiling Cable	2	16	72in (6ft)	1/4in	1.8m	6mm
67D	6ft (1.8m) Cable	—	12	72in (6ft)	1/4in	1.8m	6mm

PLEASE SEE MASTER LOCK COMMERCIAL PRICE BOOK FOR KEYED ALIKE ITEMS

KEY BLANKS: See pages 67-69 for respective key blanks or cut key information.

RETAIL PRODUCTS AVAILABLE ONLY IN MASTER CARTON OR SHELF PACK QUANTITIES.

CABLES AND CABLE LOCKS



No. 719D

- 1-1/8in (29mm) laminated steel body for superior strength
- 3ft (90cm) steel cable for strong cut resistance
- 3/16in (5mm) diameter cable for strong cut resistance
- Pin tumbler cylinder
- Protective vinyl sleeve helps prevent scratching

No. 719 Cable Lock

Product Number	Description	Shelf Pack Quantity	Master Carton Quantity	Coated Cable Length	Outside Diameter of Coated Cable	Coated Cable Length (Metric)	Outside Diameter of Coated Cable (Metric)
No. 7-pin Tumbler Padlock							
719D	Keyed Different	6	48	36in (3ft)	3/16in	90cm	5mm



No. 1519D

- 1-7/8in (48mm) double armored stainless steel lock body
- Combination security for keyless convenience
- 3ft (90cm) steel cable with protective vinyl sleeve
- 3/16in (5mm) diameter cable for strong cut resistance

No. 1519 Cable Lock

Product Number	Description	Shelf Pack Quantity	Master Carton Quantity	Coated Cable Length	Outside Diameter of Coated Cable	Coated Cable Length (Metric)	Outside Diameter of Coated Cable (Metric)
1519D	Combination Different	6	48	36in (3ft)	3/16in	90cm	5mm

PLEASE SEE MASTER LOCK COMMERCIAL PRICE BOOK FOR KEYED ALIKE ITEMS

KEY BLANKS: See pages 67-69 for respective key blanks or cut key information.

RETAIL PRODUCTS AVAILABLE ONLY IN MASTER CARTON OR SHELF PACK QUANTITIES.

TOWING SECURITY

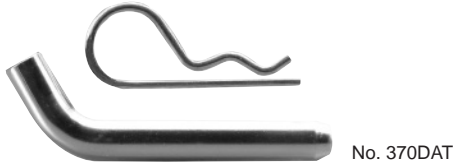

- Hardened Steel for Improved Cut and Shear Resistance
- Nickel and Chrome Plated
- Tapered Ends for Easy Insertion

Receiver Pins and Clips

Individual Product Number	Case Part Number	Description	Shelf Pack Quantity	Master Carton Quantity
370DAT	370DAT	1/2in Bent Pin	4	24
371DAT	371DAT	5/8in Bent Pin	4	24
1376DAT	1376DAT	1/2in & 5/8in Bent Pin with Stainless Steel	4	24
1414DAT	1414DAT	Sleeved Pivot Lock Hitch Pin; Fits both 1/2in & 5/8in	4	24
1415DAT	1415DATSC	Sleeved Stainless Steel Pivot Lock Hitch Pin; Fits both 1/2in & 5/8in	6	24
1465DAT	1465DAT	5/8in Stainless Steel Pivot Lock Hitch Pin	4	24
1495DAT	1495DAT	5/8in Pivot Hitch Pin	4	24
1492DAT	1492DAT	1/2in Pivot Hitch Pin	4	24
1665DAT	1665DAT	5/8in Stainless Steel Extended Length Barrel Head Hitch Pin	4	24

No. 2847DAT



- Wide Variety of Coupler Locks to Fit Many Styles
- Hardened Steel to Provide Maximum Protection
- Packaging Explains Application Usage
- 2847DAT, 2878DAT, 379ATPY and 379KAATPY have the Python cylinder that can be re-keyed

Coupler Locks

Individual Product Number	Case Part Number	Description	Shelf Pack Quantity	Master Carton Quantity
37KA	37KA	Coupler Lock, Padlock Style, Keyed Alike, K1 Keyway	6	24
37D	37D	Coupler Lock, Padlock Style, Keyed Different, K1 Keyway	4	24
2847DAT	2847DAT	Adjustable Coupler Latch Lock, Stainless Steel, 6 Locking Positions	4	24
2878DAT	2878DAT	7/8in Shackle Coupler Latch Lock	4	24
605DAT	605DAT	3/4in Shackle, Solid Brass, K130 Keyway	4	24
1491DAT	1491DAT	Trailer Coupler Pivot Lock Latch Pin	6	24
1471DAT	1471DAT	3-1/2in Long Shackle Barbell™ Lock for UFP Couplers, K1 Keyway	4	24
377KA	377KA	Keyed Alike Universal Coupler Lock, Fits 1-7/8in & 2in, K1 Keyway	—	4
377DAT	377DAT	Universal Coupler Lock, Fits 1-7/8in & 2in, K1 Keyway	—	4
379DAT	379DAT	Universal Coupler Lock, Fits 1-7/8in, 2in and 2-5/16in, Retail Package, Cut Case Display	—	2
379ATPY	379ATPY	Universal Coupler Lock, Fits 1-7/8in, 2in and 2-5/16in, Rekeyable Cylinder, Commercial Boxed	—	6
379KAATPY	379KAATPY	Universal Coupler Lock, Fits 1-7/8in, 2in and 2-5/16in, Keyed Alike, Commercial Boxed	—	6
389DAT	389DAT	Universal Trailer Coupler Lock Fits 1-7/8in, 2in and 2-5/16in, Retail Package	—	2
2999DAT	2999DAT	King Pin Coupler Lock	4	12
3784DAT	3784DAT	Heavy Duty Trailer Coupler Lock with Adjustable Coupler Latch Lock, Keyed Alike	—	2

SC or CC = Case Cut

PLEASE SEE MASTER LOCK COMMERCIAL PRICE BOOK FOR KEYED ALIKE ITEMS

KEY BLANKS: See pages 67-69 for respective key blanks or cut key information.

RETAIL PRODUCTS AVAILABLE ONLY IN MASTER CARTON OR SHELF PACK QUANTITIES.

TOWING SECURITY



- Push To Lock Locking Mechanism
- Stainless Steel Swivel Head
- K1 Key Blank

Receiver Locks

Individual Product Number	Case Part Number	Description	Shelf Pack Quantity	Master Carton Quantity
2866DAT	2866DAT	5/8in & 1/2in Chrome Steel, Swivel Head™ Lock	4	24
1469DAT	1469DAT	3-1/2in Stainless Steel Heavy-Duty Receiver Lock	4	24
1470DAT	1470DAT	5/8in & 1/2in Swivel Head™ Lock w/8' Cable	—	4
1479DAT	1479DAT	5/8in Barbell™ Lock	4	24
1479TAT	1479TAT	5/8in Barbell™ Lock, Keyed Alike Two Pack	4	16
1472DAT	1472DAT	Chrome Steel 1/2in Barbell™ Lock	4	24
1480KA	1480KA	Stainless Steel 5/8in Barbell™ Lock - Keyed Alike	4	24
1480DAT	1480DAT	Stainless Steel 5/8in Barbell™ Lock	4	24
2469DAT	2469DAT	3-1/2in Chrome Bent Pin Receiver Lock	4	24



- Keyed Alike Convenience
- Push To Lock Receiver Lock
- K1 Key Blank

Keyed Alike Sets

Individual Product Number	Case Part Number	Description	Shelf Pack Quantity	Master Carton Quantity
1481DAT	1481DAT	Stainless Steel Barbell™ Receiver (5/8in) & Adjustable Coupler Latch Lock (Nos. 1480 and 2847)	4	24
2848DAT	2848DAT	Bent Pin Receiver (5/8in & 1/2in) & Adjustable Coupler Latch Lock (Nos. 2866 and 2847)	4	24
3794DAT	3794DAT	Coupler lock, Bent Pin Receiver Lock (5/8in & 1/2in) & Coupler Latch Lock (Nos. 2847, 2866 and 379)	—	2
3895DAT	3895DAT	Coupler lock, Bent Pin Receiver Lock (5/8in & 1/2in) & Coupler Latch Lock (Nos. 2847, 2866 and 389)	—	2



- Self-Coiling Cables (Nos. 613 and 614)
- No. 613DAT has K1 Key Blank
- No. 614DAT has K130 Key Blank

Spare Tire Lock and Cable/Lock Sets

Individual Product Number	Case Part Number	Description	Shelf Pack Quantity	Master Carton Quantity
613DAT	613DAT	6ft Self-coiling Cable & Covered Laminated Steel Padlock	4	16
614DAT	614DAT	6ft Self-coiling Cable & Covered Aluminum Padlock	4	24
262DAT	262DAT	Spare Tire Lock, Lug Nut Style	4	24

PLEASE SEE MASTER LOCK COMMERCIAL PRICE BOOK FOR KEYED ALIKE ITEMS

KEY BLANKS: See pages 67-69 for respective key blanks or cut key information.

RETAIL PRODUCTS AVAILABLE ONLY IN MASTER CARTON OR SHELF PACK QUANTITIES.



- One Size Fits Most Vehicles: Cars, Trucks, SUV's, and RV's
- Easy to Install
- Single Steering Wheel Cut Cannot Defeat

Steering Wheel Locks

Individual Product Number	Case Part Number	Description	Shelf Pack Quantity	Master Carton Quantity
256DAT	256DAT	Pedal to Wheel Lock	—	4
252DAT	252DAT	Advanced Security Steering Wheel Lock "Quad Hook"	—	2
263DAT	263DAT	Titanium Series High Security Steering Wheel Lock "Quad Hook"	—	4



No. 61DAT



No. 8142DAT

- 6ft- 7ft (1.8m-2.4m) Cable Lengths will Accommodate Most Tires and General Applications
- Nos. 61DAT and 614DAT Cables are Self-Coiling for Storage Ease
- Padlocks Included in Nos. 613DAT and 614DAT Chosen for Corrosion Resistance

Cable and Cable Locks

Individual Product Number	Case Part Number	Description	Shelf Pack Quantity	Master Carton Quantity
61DAT	61DAT	6ft (1.8m), 1/4in (6mm) Dia, Self Coiling Black Cable	4	16
613DAT	613DAT	6ft Self-coiling Cable & Cover Laminated Steel Padlock	4	16
614DAT	614DAT	6ft Self-coiling Cable & Cover Aluminum Padlock	4	24
715DAT	715DAT	Car Cover Cable & Lock Kit, 7' (2.1m) Cable and No. 105 Warded Lock	4	24
8142DAT	8142DAT	6ft (1.8m), 7/16in (12mm) Dia, Cable with Integrated Keyed Lock	4	16

SC or CC = Case Cut

PLEASE SEE MASTER LOCK COMMERCIAL PRICE BOOK FOR KEYED ALIKE ITEMS

KEY BLANKS: See pages 67-69 for respective key blanks or cut key information.

RETAIL PRODUCTS AVAILABLE ONLY IN MASTER CARTON OR SHELF PACK QUANTITIES.

TRUCK BED SECURITY



No. 8253DAT

- Prevents the removal of a pickup tailgate
- Installs without removing the tail gate on most models
- Fits most late model Ford, GM, Dodge, and Toyota Tundra trucks
- Stainless Steel
- Hook and loop pads included to prevent rattle
- Installs in minutes
- Keyway cover protects lock mechanism from corrosion

Tailgate Lock

Individual Product Number	Description	Shelf Pack Quantity	Master Carton Quantity
8253DAT	Tailgate Lock	1	4

CARGO SECURITY



No. 3039DAT

- World's First Reverse Hook Bends Away Allowing More Room to Attach
- Flat, Steel I-beam Hook is 3X Stronger than Traditional Bungee Hooks
- Premium Quality Rubber for Superior Strength and Elasticity

SteelCor™ Bungee Cord

Individual Product Number	Case Part Number	Description	Shelf Pack Quantity	Master Carton Quantity
3039DAT	3039DAT	20in- 40in x 9.5mm Adjustable SteelCor™ Bungee	6	48

SC or CC = Case Cut

PLEASE SEE MASTER LOCK COMMERCIAL PRICE BOOK FOR KEYED ALIKE ITEMS

KEY BLANKS: See pages 67-69 for respective key blanks or cut key information.

RETAIL PRODUCTS AVAILABLE ONLY IN MASTER CARTON OR SHELF PACK QUANTITIES.



No. 3041DAT

- Simple and Easy Option for Storing and Organizing Bungee Cords
- Built-in Handle for Easy Transportation and Hanging When Not in Use

SteelCor™ Bungee Cord Organizer

Individual Product Number	Case Part Number	Description	Shelf Pack Quantity	Master Carton Quantity
3041DAT	3041DATSC	10 Count- 2 pcs. Each: 18in x 9.5mm, 24in x 9.5mm, 32in x 9.5mm, 40in x 9.5mm, 10in minis	—	4



No. 3029DAT

- Cord Stays in Place, Even When They Are Not in Tension
- Patented Hook Locks into Place

TarpLok™ Bungee Cord

Individual Product Number	Case Part Number	Description	Shelf Pack Quantity	Master Carton Quantity
3029DAT	3029DAT	32in TarpLok™ Bungee Cord	6	72



No. 3030DAT

- Patented Design Allows for Positive Grip of Hook for Improved Operating Safety

EZ Grip™ Bungee Cords

Individual Product Number	Case Part Number	Description	Shelf Pack Quantity	Master Carton Quantity
3030DAT	3030DAT	24in EZ Grip™ Bungee Cord	6	72
3031DAT	3031DAT	32in EZ Grip™ Bungee Cord	6	72

SC or CC = Case Cut

PLEASE SEE MASTER LOCK COMMERCIAL PRICE BOOK FOR KEYED ALIKE ITEMS

KEY BLANKS: See pages 67-69 for respective key blanks or cut key information.

RETAIL PRODUCTS AVAILABLE ONLY IN MASTER CARTON OR SHELF PACK QUANTITIES.



No. 3120DAT

- Reverse Hook Design Allow More Room To Attach
- Two Wires in our Hook Offers Twice the Strength of Traditional Bungees
- Rounded Hook End Eliminates Risk of Scratching
- Bulk Merchandising Cut Case Option Offers Impulse Buying at the Register

Reverse Twin Wire Bungees

Individual Product Number	Case Part Number	Description	Shelf Pack Quantity	Master Carton Quantity
Bulk				
3120DAT	3120DATSC	24in x 8mm Red Bungee Cord	—	25
Packaged in a Clear PVC Bag with a Foldover Card				
3018DAT	3018DAT	10in x 4mm Mini Bungee Cords, 4 pk	12	72
3019DAT	3019DAT	18in x 8mm Blue Bungee Cord, 2 pk	6	72
3020DAT	3020DAT	24in x 8mm Red Bungee Cord, 2 pk	6	72
3021DAT	3021DAT	32in x 8mm Green Bungee Cord, 2 pk	6	72



No. 3023AT

- Reverse Hook Design Allow More Room To Attach
- Two Wires in our Hook Offers Twice the Strength of Traditional Bungees
- Rounded Hook End Eliminates Risk of Scratching

Reverse Twin Wire Bungee Assortments

Individual Product Number	Case Part Number	Description	Shelf Pack Quantity	Master Carton Quantity
3023AT	3023AT	24 pcs. Asst. Bungees (6 - 18in; 4 - 24in; 2 - 32in; 2 - 40in; 4 - 6in Canopy; 6 - mini), Jar	—	6
3026DAT	3026DAT	6 pcs. Asst. Bungees (2 - 18in; 1 - 24in; 1 - 32in; 2 - mini), Bag	6	48

SC or CC = Case Cut

PLEASE SEE MASTER LOCK COMMERCIAL PRICE BOOK FOR KEYED ALIKE ITEMS

KEY BLANKS: See pages 67-69 for respective key blanks or cut key information.

RETAIL PRODUCTS AVAILABLE ONLY IN MASTER CARTON OR SHELF PACK QUANTITIES.



No. 3044DAT

- Reverse Hook Design Allow More Room To Attach
- Simple and Easy Option for Storing and Organizing Bungee Cords
- Built-in Handle for Easy Transportation and Hanging When Not in Use

Reverse Twin Wire Bungee Organizer

Individual Product Number	Case Part Number	Description	Shelf Pack Quantity	Master Carton Quantity
3044DAT	3044DATSC	15 Count- 6 - 18in x 8mm, 4 - 24in x 8mm, 3 - 32in x 8mm, 2 - 40in x 8mm	—	4



No. 3156DAT

- Single Pack Ratchets in Cut Case Display to Maximize Selling Source
- Heavy Duty Ratchet Features S Hooks

Standard Ratchet Tie-Down

Individual Product Number	Case Part Number	Description	Shelf Pack Quantity	Master Carton Quantity
3156DAT	3156DATSC	10ft x 1in Ratchet Tie Down, 900 lbs. 4 pk, Plastic Package	—	4



No. 3054DAT

- Monster Weave™ Strapping for Added Strength and Durability
- S-hooks with Retention Clips Keep Hooks in Place
- Clamshell Package

Step-Up Ratchet Tie-Down

Individual Product Number	Case Part Number	Description	Shelf Pack Quantity	Master Carton Quantity
3054DAT	3054DAT	12ft x 1in Endless Ratchet Tiedown, 1,500/500 lbs	—	4

SC or CC = Case Cut

PLEASE SEE MASTER LOCK COMMERCIAL PRICE BOOK FOR KEYED ALIKE ITEMS

KEY BLANKS: See pages 67-69 for respective key blanks or cut key information.

RETAIL PRODUCTS AVAILABLE ONLY IN MASTER CARTON OR SHELF PACK QUANTITIES.



No. 3053DAT

- Over-molded Grips Protect and Aid in Operation
- S-hooks with Retention Clips Keep Hooks in Place
- Bungee Cord and Toggle to Keep Strap Firmly in Place During Use
- Ideal for Storing Tie Downs When Not in Use
- Consumer Interactive Injection Molded Package

Premium Ratchet Tie-Downs with Strap Trap™

Individual Product Number	Case Part Number	Description	Shelf Pack Quantity	Master Carton Quantity
3053DAT	3053DATSC	6ft x 1in Ratchet Tie-Downs with Strap Trap™, S Hooks with Clips, 2 pk, 1,800/600 lbs	3	6
3057DAT	3057DATSC	10ft x 1in Ratchet Tie-Down with Strap Trap™, S Hooks with Clips, 2 pk, 3,300/1,100 lbs	—	4



No. 3113DAT

- Over-molded Grips Protect and Aid in Operation
- Monster Weave™ Strapping for Added Strength and Durability
- S-hooks with Retention Clips Keep Hooks in Place
- Bungee Cord and Toggle to Keep Strap Firmly in Place During Use
- Ideal for Storing Tie Downs When Not in Use
- Consumer Interactive Injection Molded Package

Premium Spring Clamp Tie-Downs with Strap Trap™

Individual Product Number	Case Part Number	Description	Shelf Pack Quantity	Master Carton Quantity
3113DAT	3113DATSC	6ft x 1in Spring Clamp Tie-Down with Strap Trap™, S Hooks with Clips, 2 pk, 1,200/400 lbs	—	4

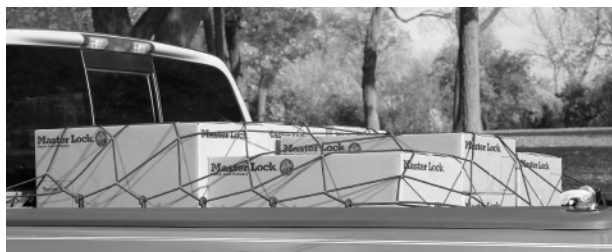

No. 3052DAT

- UV and Weather Resistance

Cargo Net

Individual Product Number	Case Part Number	Description	Shelf Pack Quantity	Master Carton Quantity
3052DAT	3052DAT	Adjustable Pickup Cargo Net, 60in x 78in with Storage Bag	—	2

SC or CC = Case Cut

PLEASE SEE MASTER LOCK COMMERCIAL PRICE BOOK FOR KEYED ALIKE ITEMS

KEY BLANKS: See pages 67-69 for respective key blanks or cut key information.

RETAIL PRODUCTS AVAILABLE ONLY IN MASTER CARTON OR SHELF PACK QUANTITIES.

POWER SPORTS SERIES



No. 8290DPS

- Compact and lightweight – easily fits in cargo areas
- 3in (8cm) Cuff fits fork legs or frames; can be secured to sign posts, parking meters or another bike
- Push button keyless locking convenience
- Heat treated patented lock core is virtually pick proof
- Pivoting action combined with 22in (55cm) length provides lockdown versatility

No. 8290 Street Cuff® Lock

Product Number	Description	Shelf Pack Quantity	Master Carton Quantity
8290DPS	Street Cuff® - 9 Link; 3in (8cm) x 22in (55cm)	—	6



No. 8291DPS

- 3ft (90cm) Chain Lock
- Tough square-linked, hardened steel chain resists cutting
- Nylon cover protects equipment
- Disc key for additional anti-pick protection
- Keyway cover keeps lock core clean and dry

No. 8291 Tuff Links® Chain

Product Number	Description	Shelf Pack Quantity	Master Carton Quantity	Chain Length	Outside Diameter of Chain	Chain Length (Metric)	Outside Diameter of Chain (Metric)
8291DPS	Tuff Links® 3ft (90cm) Chain with Integrated Keyed Lock	—	4	3ft	3/8in	90cm	9mm



No. 8118DPF

- Hardened shackle resists cutting and sawing
- High security anti-pick lock cylinder
- Vinyl coating helps prevent scratches

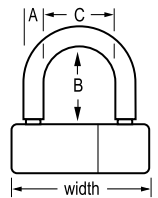

No. 8118 Mini U-Lock

Product Number	Description	Shelf Pack Quantity	Master Carton Quantity	Shackle Dimensions			Shackle Dimensions (Metric)		
				A	B	C	A	B	C
8118DPF	Mini U-lock; 3-15/16in (100mm) x 2in (50mm)	4	24	1/2in	2in	1-5/8in	12mm	50mm	42mm

SC or CC = Case Cut

PLEASE SEE MASTER LOCK COMMERCIAL PRICE BOOK FOR KEYED ALIKE ITEMS

KEY BLANKS: See pages 67-69 for respective key blanks or cut key information.

RETAIL PRODUCTS AVAILABLE ONLY IN MASTER CARTON OR SHELF PACK QUANTITIES.

POWER SPORTS SERIES



No. 8303DPS

- Prevents roll-away theft
- Steel shackle
- Easy push button locking system with high security cylinder
- Bright orange cord to help remind you to remove lock before riding
- No. 8304DPS includes a carrying case

Disc Brake Locks

Product Number	Description	Shelf Pack Quantity	Master Carton Quantity
8303DPS	2in (5cm) Disc Brake Lock with a 1/4in (6mm) Shackle	4	12
8304DPS	3in (8cm) Disc Brake Lock with a 3/8in (10mm) Shackle	4	12



No. 8428DPS

- Patented locking mechanism holds the cable tight at any length
- 6ft (1.8m) to 30ft (9.1m) interchangeable cable provides enough versatility for any application
- Cut resistant 3/8in (10mm) braided cable
- Weather Tough® aluminum alloy lock, cylinder shutter and vinyl coated cable

No. 8428 Python® Adjustable Locking Cable

Product Number	Description	Shelf Pack Quantity	Master Carton Quantity	Cable Length	Outside Diameter of Cable	Cable Length (Metric)	Outside Diameter of Cable (Metric)
8428DPS	Python® Adjustable Cable Lock; 6ft (1.8m) x 3/8in (10mm)	—	6	6ft	3/8in	1.8m	10mm



No. 8218DPS

- Braided steel cable resists cutting and sawing
- High security anti-pick lock cylinder
- Vinyl coating helps prevent scratches
- No. 8218DPS has a hardened steel sleeve over the braided cable
- No. 8156DPS has looped end and integrated mini U-lock for greater locking versatility

Cable Locks

Product Number	Description	Shelf Pack Quantity	Master Carton Quantity	Cable Length	Outside Diameter of Cable	Cable Length (Metric)	Outside Diameter of Cable (Metric)
8218DPS	Keyed Different Armored Cable Lock; 6ft (1.8m) x 1-3/16in (30mm)	4	12	6ft	1-3/16in	1.8m	30mm
8157DPS	Keyed Different Cable Lock; 6ft (1.8m) x 9/16in (15mm)	—	4	6ft	9/16in	1.8m	15mm

PLEASE SEE MASTER LOCK COMMERCIAL PRICE BOOK FOR KEYED ALIKE ITEMS

KEY BLANKS: See pages 67-69 for respective key blanks or cut key information.

RETAIL PRODUCTS AVAILABLE ONLY IN MASTER CARTON OR SHELF PACK QUANTITIES.

SECURITY BAR



- For hinged and sliding doors
- Top piece removes for sliding door application
- Adjusts to fit most standard doors
- Rugged 20 gauge steel construction
- Pivoting ball joint assures full contact with floor
- Padded foot provides sure grip without scratching

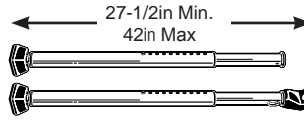

No. 265 Security Bar

Product Number	Description	Master Carton Quantity
265DCCSEN	Dual Function Door Security Bar	3

STORAGE SECURITY



The Master Lock SafeSpace® product line offers a variety of convenient locking solutions to keep valuables safe & secure



No. 5900D



No. 5900DWHT

- Ideal for recreation, campus, office, travel or leisure use
- Lightweight & Portable. Protects MP3 players, cell phones, cameras, gaming devices, cash, credit cards, jewelry, keys, passports, sunglasses or other small valuables
- Lock Up & Lock Down. Lock up valuables with the cable wrapped tightly to the safe or wrapped securely around a fixed object. Cable doubles as a carrying handle
- Durable water-resistant construction
- Set your own Combination for locking convenience
- Ear Bud/Charging Cable Access Port
- Shock absorbing foam lines the interior storage area

SAFESPACE® Portable Personal Safes

Product Number	Description	Master Carton Quantity
5900D	Portable Personal Safe - Gunmetal Gray; 8-1/2in L x 4in W x 1-5/8in D	2
5900DWHT	Portable Personal Safe - White; 8-1/2in L x 4in W x 1-5/8in D	2



No. 7116D



No. 7117D

- Fits most key cabinets and key racks
- No. 7117 snap hook design fits slotted and key style key cabinets, boards, etc. For use with 7122D, 7125D and 7126D

SAFESPACE® Plastic Key Tags and Hangers

Product Number	Description	Master Carton Quantity
7116D	Plastic Key Tags; 20 tags per bag. 1-1/4in (32mm) x 1-1/10in (28mm) x 1/2in (12mm)	10 bags
7117D	Plastic Key Holder; 20 holders per bag. 1-1/2in (38mm) x 1-2/3in (42mm) x 4/5in (20mm)	10 bags

PLEASE SEE MASTER LOCK COMMERCIAL PRICE BOOK FOR KEYED ALIKE ITEMS

KEY BLANKS: See pages 67-69 for respective key blanks or cut key information.

RETAIL PRODUCTS AVAILABLE ONLY IN MASTER CARTON OR SHELF PACK QUANTITIES.



Master Lock *Bluetooth*® Lock Boxes offer the freedom to protect and control access to homes, businesses or vacation properties right from your smartphone. The free and intuitive Master Lock Vault® App allows users to assign who can access their property, and for how long. It's the smart and simple way to confidently secure property and manage access from anywhere at any time.



- Open and manage lock boxes with your smartphone
- Share permanent or temporary access with the Master Lock Vault app, or manual codes
- Monitor access history and receive notifications
- Optional manual code access via keypad when smartphone is not available
- Receive low battery notifications on lock box and in app

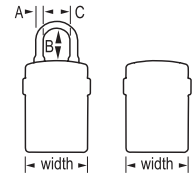

Bluetooth® Lock Boxes

Product Number	Description	Shelf Pack Quantity	Master Carton Quantity	Shackle Dimensions			Shackle Dimensions (Metric)		
				A	B	C	A	B	C
5440D	3-1/4in wide, Bluetooth® Portable Lock Box	1	2	13/32in	1-13/16in	1-13/32in	10mm	46mm	36mm
5441D	3-1/4in wide, Bluetooth® Wall Mount Lock Box	1	2	NA	NA	NA	NA	NA	NA



- Large Easy to Read Light-Up Dials
- Dials light up automatically when cover is opened
- Large Open Lever for more comfortable use
- Durable Weather Cover prevents freezing and jamming
- Vinyl Coated Shackle and Molded Bumper prevents scratches to your door
- Hidden Hinge and Recessed Compartment prevents door from jamming
- Set Your Own Combination for easy-to-use convenience
10,000 possible combinations

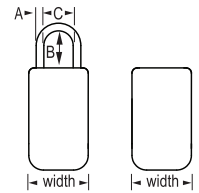

SAFESPACE® Light-Up Dial Lock Boxes

Product Number	Description	Shelf Pack Quantity	Master Carton Quantity	Shackle Dimensions			Shackle Dimensions (Metric)		
				A	B	C	A	B	C
5424D	2-7/8in (72mm) wide, Portable Light-Up Dial Lock Box	—	4	3/8in	1-11/16in	1-13/32in	9mm	43mm	36mm
5425D	2-7/8in (72mm) wide, Wall Mount Light-Up Dial Lock Box	—	4	NA	NA	NA	NA	NA	NA

PLEASE SEE MASTER LOCK COMMERCIAL PRICE BOOK FOR KEYPED ALIKE ITEMS

KEY BLANKS: See pages 67-69 for respective key blanks or cut key information.

RETAIL PRODUCTS AVAILABLE ONLY IN MASTER CARTON OR SHELF PACK QUANTITIES.

STORAGE SECURITY



No. 5400D



No. 5406D



No. 5408D

- Storage compartment holds multiple house, car or padlock keys
- No lockouts or schedule conflicts
- Locking combination convenience
- Durable metal construction

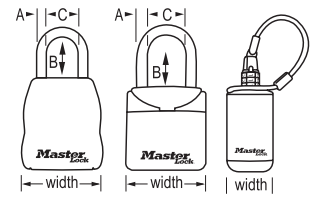

SAFESPACE® Combination Dial Portable Lock Boxes

Product Number	Description	Shelf Pack Quantity	Master Carton Quantity	Shackle Dimensions			Shackle Dimensions (Metric)		
				A	B	C	A	B	C
5400D	Portable Lock Box; Set Your Own 4-digit Combination; Holds up to 5 keys; 3-1/4in (83mm) wide	—	4	13/32in	1-7/8in	1-13/32in	10mm	47mm	36mm
5406D	Compact Portable Lock Box; Set Your Own 3-digit Combination; Holds 2-3 keys; 2-3/4in (70mm) wide	2	4	13/32in	1-7/8in	1-13/32in	10mm	47mm	36mm
5408D	Mini Safe Preset Combination; For Keys, Cash, Jewelry 1-3/4in (44mm) wide	4	16	NA	NA	NA	NA	NA	NA



No. 5420D

- Adjustable shackle fits securely on most door hardware styles
- Portable lock box provides secure storage of keys or access cards
- Large Open Lever for more comfortable use
- Durable weather cover prevents freezing and jamming
- Vinyl coated shackle and molded bumper prevents scratches to your door

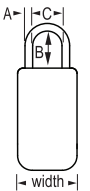

SAFESPACE® Universal Lock Box

Product Number	Description	Shelf Pack Quantity	Master Carton Quantity	Shackle Dimensions			Shackle Dimensions (Metric)		
				A	B	C	A	B	C
5420D	Portable Universal Lock Box; Set Your Own 4-Digit Combination; Holds up to 5 keys; 2-7/8in (72mm) wide	—	4	3/8in	3/4-1-3/4in	1-13/32in	9mm	19-44mm	36mm



No. 5401D

- Storage compartment holds multiple house, car or padlock keys
- No lockouts or schedule conflicts
- Set your own combination convenience



SAFESPACE® Combination Dial Wall Mount Lock Box

Product Number	Description	Shelf Pack Quantity	Master Carton Quantity	Shackle Dimensions			Shackle Dimensions (Metric)		
				A	B	C	A	B	C
5401D	Wall Mount Lock Box; Set Your Own Combination Holds up to 5 keys; 3-1/4in (83mm) wide	—	4	NA	NA	NA	NA	NA	NA

PLEASE SEE MASTER LOCK COMMERCIAL PRICE BOOK FOR KEYED ALIKE ITEMS

KEY BLANKS: See pages 67-69 for respective key blanks or cut key information.

RETAIL PRODUCTS AVAILABLE ONLY IN MASTER CARTON OR SHELF PACK QUANTITIES.

STORAGE SECURITY



- Provides secure storage of keys or access cards
- Convenient push button locking mechanism in familiar alpha / numeric telephone keypad format
- Set your own combination using up to 12 letters, numbers, or both
- Large buttons for ease of use, even in low light conditions
- Large internal cavity and removable key hook prevents jamming
- Protective weather cover prevents freezing and jamming

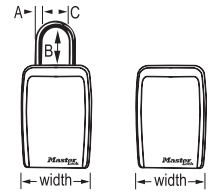

SAFESPACE® Push Button Lock Boxes

Product Number	Description	Shelf Pack Quantity	Master Carton Quantity	Shackle Dimensions			Shackle Dimensions (Metric)		
				A	B	C	A	B	C
5422D	3-1/8in (79mm) Wide Set Your Own Combination Push Button Portable Lock Box	—	4	13/32in	1-5/6in	1-13/32in	10mm	46mm	36mm
5423D	3-1/8in (79mm) Wide Set Your Own Combination Push Button Wall Mount Lock Box	—	4	NA	NA	NA	NA	NA	NA



No. 7120D

- Safely carry cash, jewelry and confidential documents
- Water resistant nylon
- Built in high security lock
- Identification holder and card

SAFESPACE® Storage Bag

Product Number	Description	Master Carton Quantity
7120D	Locking Storage Bag. 11-1/2in (29cm) x 8-3/8in (21cm) x 1-3/8in (3.5cm)	6



No. 207D

- Large internal capacity fits most keys, including keys with integrated FOB*
- Rust free, durable plastic construction
- Recessed magnet securely attaches and holds case to any steel surface
- Improved sliding cover design with built-in stop to prevent cover from being dropped or misplaced
- New discreet design to conceal your keys

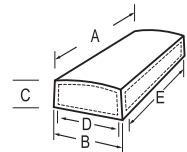

*This product is not intended to be waterproof and is not recommended for outdoor use with electronic items

SAFESPACE® Magnetic Key Case

Product Number	Description	Shelf Pack Quantity	Master Carton Quantity	Product Dimensions					Product Dimensions (Metric)				
				A	B	C	D	E	A	B	C	D	E
207D	Large Magnetic Key Case	4	24	4-11/16in	2in	1-3/16in	1-5/8in	3-7/8in	119mm	51mm	29mm	41mm	97mm

PLEASE SEE MASTER LOCK COMMERCIAL PRICE BOOK FOR KEYED ALIKE ITEMS

KEY BLANKS: See pages 67-69 for respective key blanks or cut key information.

RETAIL PRODUCTS AVAILABLE ONLY IN MASTER CARTON OR SHELF PACK QUANTITIES.

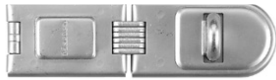

No. 720DPF

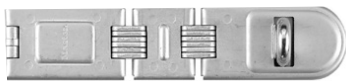

No. 722DPF

- Secure hard-to-lock property
- Hardened steel body for added strength
- Hardened boron alloy staples resist cutting and sawing
- Single and double hinge styles with hidden hinge pins
- Ideal for reaching around corners and angles

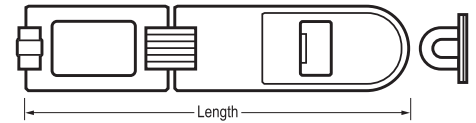

Hinged Hasps

Product Number	Description	Shelf Pack Quantity	Master Carton Quantity	Hasp Length	Accepts Shackles Dia. Up To:	Hasp Length (Metric)	Accepts Shackles Dia. (Metric) Up To:
720DPF	6-1/4in (16cm) Single-hinge	4	24	6-1/4in	7/16in	16cm	11mm
722DPF	7-3/4in (20cm) Double-hinge	4	24	7-3/4in	7/16in	20cm	11mm



No. 730DPF



No. 732DPF

- Zinc plated hardened steel for added strength and weatherability
- Hardened steel staple resists cutting, sawing and hammering
- Hasp body conceals mounting hardware
- Mounting hardware included for easy installation
- No. 730 is ideal for utility vans, trailers, gang boxes, vending machines

Heavy Duty Hasps

Product Number	Description	Shelf Pack Quantity	Master Carton Quantity	Hasp Length	Accepts Shackles Dia. Up To:	Hasp Length (Metric)	Accepts Shackles Dia. (Metric) Up To:
730DPF	7-1/4in (18cm) Straight Bar	4	24	7-1/4in	7/16in	18cm	11mm
732DPF	90° Angle Bar		24	4-13/16in	7/16in	12cm	11mm



No. 703D

- Hard wrought steel and hardened steel bodies for strength
- Hardened steel staples resist cutting and sawing
- Hardened steel locking eyes for strong cut resistance
- Tamper proof hinges help resist prying

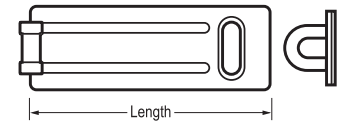

General Use Hasps

Product Number	Description	Shelf Pack Quantity	Master Carton Quantity	Hasp Length	Accepts Shackles Dia. Up To:	Hasp Length (Metric)	Accepts Shackles Dia. (Metric) Up To:
702D	2-1/2in (64mm) Hard Wrought Steel Body	4	24	2-1/2in	9/32in	6.4cm	7mm
703D	3-1/2in (89mm) Hard Wrought Steel Body	4	24	3-1/2in	11/32in	9cm	9mm
704DPF	4-1/2in (11cm) Hard Wrought Steel Body	4	24	4-1/2in	1/2in	11cm	13mm
706D	6in (15cm) Hardened Steel Body with Reinforced Plate	4	24	6in	9/16in	15cm	14mm



No. 450D

- Hasps with integral locking mechanisms for security and convenience
- Hardened steel hasps with laminated steel lock body
- Ribbed hasp plate for extra strength
- Hardened steel locking eye for strong cut resistance
- Duplicate keys not available

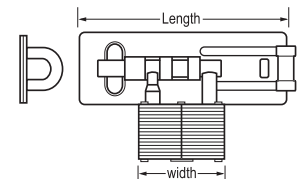

No. 450 Padlock

Product Number	Description	Shelf Pack Quantity	Master Carton Quantity	Hasp Length	Accepts Shackles Dia. Up To:	Hasp Length (Metric)	Accepts Shackles Dia. (Metric) Up To:
General-Use Hasplocks, Warded Mechanism							
450D	Keyed Different	4	24	4-1/2in	1-3/4in	11cm	44mm

PLEASE SEE MASTER LOCK COMMERCIAL PRICE BOOK FOR KEYED ALIKE ITEMS

KEY BLANKS: See pages 67-69 for respective key blanks or cut key information.

RETAIL PRODUCTS AVAILABLE ONLY IN MASTER CARTON OR SHELF PACK QUANTITIES.

RETAIL PRODUCT DISPLAYS



- Increase padlock sales through strategic placement of Master Lock clip strips
- Manage your retail space efficiently
- Displays are pre-loaded –ideal for generating incremental sales in impulse areas

ORDERING INFORMATION

- Clipstrips must be ordered as "eaches" in multiples of 12 and will be charged per lock, i.e. an order quantity of 12 will ship two clipstrips, (each loaded with 6 locks for a total of 12 locks).

No. 1530DCMCLP

Clip Strips

Product Number	Description	Master Carton Quantity
1500DCLP	2 Pre-loaded Clip Strips each w/6 No. 1500D (12 total locks)	12
1530DCMCLP	2 Pre-loaded Clip Strips each w/6 No. 1530DCM (12 total locks)	12



No. 1224GENXTM

- Provides high visibility to stimulate impulse purchases
- Place on counter for great add-on sales potential
- Pre-assembled, pre-loaded, refillable
- Category-specific header graphics ship with Back-to-School displays

ORDERING INFORMATION

- Displays must be ordered as 1 unit and will ship with 12 locks in the display. Display will be invoiced as 1 unit.

Counter Displays

Product Number	Description	Display Carton Quantity
1224GENBLK	Display w/12 No. 1500D	1
1224GENXTM	Display w/12 No. 1530DCM	1

PLEASE SEE MASTER LOCK COMMERCIAL PRICE BOOK FOR KEYED ALIKE ITEMS

KEY BLANKS: See pages 67-69 for respective key blanks or cut key information.

RETAIL PRODUCTS AVAILABLE ONLY IN MASTER CARTON OR SHELF PACK QUANTITIES.



No. 1273CARSM

- Clear plastic bowl provides full view of carabiners
- Create impulse sales at check out, service counters and key cutting machines
- Not for climbing

Bulk Counter Display

Product Number	Description	Display Carton Quantity
1273CARSM	Carabiner Display; 40 pcs in Plastic Counter Bin	1



No. 1225GENBLK

- Make effective use of floor space
- Reinforced structure provides greater durability in high-traffic environments
- Tray-style structure offers greater peripheral product visibility
- Space-efficient displays feature prominent branding
- Category-specific header graphics ship with Back-to-School displays
- Pre-loaded, refillable

ORDERING INFORMATION

- Displays must be ordered as 1 unit and will ship with lock quantity noted in the description. Display will be invoiced as 1 unit.

Floor and Sidekick Displays

Product Number	Description	Display Carton Quantity
1225GENBLK	Display w/36 No. 1500D	1
1225GENXTM	Display w/36 No. 1530DCM	1
1235GENTXM	Display w/72 No. 1530DCM	1

PLEASE SEE MASTER LOCK COMMERCIAL PRICE BOOK FOR KEYED ALIKE ITEMS

KEY BLANKS: See pages 67-69 for respective key blanks or cut key information.

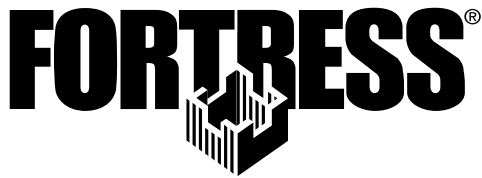

- The Fortress® offering provides an opening-price point padlock line for the price conscious consumer
- Fortress® items should accompany Master Lock branded products to provide a complete product offering
- The Fortress® offering is backed by the same solid Master Lock support and comes with a limited lifetime warranty



No. 1803D

- 1-1/8in (29mm), 1-1/2in (38mm), 2in (51mm) laminated steel lock bodies
- Case hardened steel shackles
- 4-pin cylinder

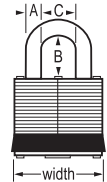

Laminated Steel Pin Tumbler Padlocks

Product Number	Description	Shelf Pack Quantity	Master Carton Quantity	Shackle Dimensions			Shackle Dimensions (Metric)		
				A	B	C	A	B	C
1-1/2in (38mm) wide, Laminated Steel Body, 4-pin Tumbler Security									
1803D	Keyed Different	4	24	1/4in	7/8in	3/4in	6mm	22mm	19mm
1803DLF	Keyed Different; 1-1/2in (38mm) Shackle	4	24	1/4in	1-1/2in	3/4in	6mm	38mm	19mm
1803T	2-Pack of No. 1803 Keyed Alike	4	16	1/4in	7/8in	3/4in	6mm	22mm	19mm
1803Q	4-Pack of No. 1803 Keyed Alike	4	16	1/4in	7/8in	3/4in	6mm	22mm	19mm
2in (51mm) wide, Laminated Steel Body, 4-pin Tumbler Security									
1805D	Keyed Different	4	24	5/16in	1-1/4in	1in	8mm	32mm	25mm
1805T	2-Pack of No. 1805 Keyed Alike	4	16	5/16in	1-1/4in	1in	8mm	32mm	25mm
1805TRI	3-Pack of No. 1805 Keyed Alike	4	16	5/16in	1-1/4in	1in	8mm	32mm	25mm
1-1/8in (29mm) wide, Laminated Steel Body, 4-pin Tumbler Security									
1807D	Keyed Different	4	24	3/16in	5/8in	9/16in	5mm	16mm	14mm



No. 1804D

- Thermoplastic cover for water resistance
- Case hardened steel shackle
- 4-pin cylinder

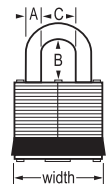

Covered Laminated Steel Pin Tumbler Padlocks

Product Number	Description	Shelf Pack Quantity	Master Carton Quantity	Shackle Dimensions			Shackle Dimensions (Metric)		
				A	B	C	A	B	C
1-9/16in (40mm) wide, Covered Laminated Steel Body, 4-pin Tumbler Security									
1804D	Keyed Different	4	24	5/16in	7/8in	13/16in	8mm	22mm	21mm
1804TRI	3-Pack of No. 1804 Keyed Alike	4	16	5/16in	7/8in	13/16in	8mm	22mm	21mm

PLEASE SEE MASTER LOCK COMMERCIAL PRICE BOOK FOR KEYED ALIKE ITEMS

KEY BLANKS: See pages 67-69 for respective key blanks or cut key information.

RETAIL PRODUCTS AVAILABLE ONLY IN MASTER CARTON OR SHELF PACK QUANTITIES.



No. 357D

- 2-3/4in (70mm) stainless steel body
- Hardened steel shackle
- 4-pin cylinder

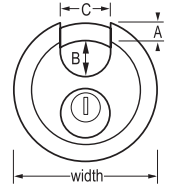

No. 357 Shrouded Padlock

Product Number	Description	Shelf Pack Quantity	Master Carton Quantity	Shackle Dimensions			Shackle Dimensions (Metric)		
				A	B	C	A	B	C
2-3/4in (70mm) wide, Stainless Steel Body, 4-pin Tumbler Security									
357D	Keyed Different	4	24	3/8in	5/8in	3/4in	10mm	16mm	19mm



No. 8525T

- 1in (25mm) steel lock body
- Steel shackle
- Warded locking mechanism

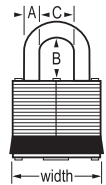

No. 8525 Warded Steel Padlocks

Product Number	Description	Shelf Pack Quantity	Master Carton Quantity	Shackle Dimensions			Shackle Dimensions (Metric)		
				A	B	C	A	B	C
1in (25mm) wide, Warded Steel Body									
8525T	2-pack of No. 8525 Keyed Alike	4	16	5/32in	7/16in	13/32in	4mm	11mm	10mm



No. 1850D

- 1-7/8in (48mm) stainless steel lock body
- Case hardened steel shackle
- 3-digit dialing

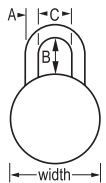

No. 1850 Combination Padlock

Product Number	Description	Shelf Pack Quantity	Master Carton Quantity	Shackle Dimensions			Shackle Dimensions (Metric)		
				A	B	C	A	B	C
1-7/8in (48mm) wide, Stainless Steel Body									
1850D	Combination Different	4	24	5/16in	3/4in	7/8in	8mm	19mm	22mm

PLEASE SEE MASTER LOCK COMMERCIAL PRICE BOOK FOR KEYED ALIKE ITEMS

KEY BLANKS: See pages 67-69 for respective key blanks or cut key information.

RETAIL PRODUCTS AVAILABLE ONLY IN MASTER CARTON OR SHELF PACK QUANTITIES.



No. 1830D

- 3/4in (20mm), 1in (25mm), 1-3/16in (30mm), 1-1/2in (40mm) solid body padlocks
- Case hardened steel shackle
- 3-pin and 4-pin cylinders

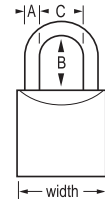

Solid Body Padlocks

Product Number	Description	Shelf Pack Quantity	Master Carton Quantity	Shackle Dimensions			Shackle Dimensions (Metric)		
				A	B	C	A	B	C
3/4in (20mm) wide, Solid Body, 3-pin Tumbler Security									
1820T	2-Pack of No. 1820 Keyed Alike	4	16	9/64in	25/64in	23/64in	4mm	10mm	9mm
1820Q	4-Pack of No. 1820 Keyed Alike	4	16	9/64in	25/64in	23/64in	4mm	10mm	9mm
1in (25mm) wide, Solid Body, 3-pin Tumbler Security									
1825D	Keyed Different	4	24	5/32in	29/64in	15/32in	4mm	12mm	12mm
1-3/16in (30mm) wide, Solid Body, 3-pin Tumbler Security									
1830D	Keyed Different	4	24	3/16in	9/16in	9/16in	5mm	14mm	14mm
1830T	2-Pack of No. 1830 Keyed Alike	4	16	3/16in	9/16in	9/16in	5mm	14mm	14mm
1-1/2in (40mm) wide, Solid Body, 4-pin Tumbler Security									
1840D	Keyed Different	4	24	1/4in	7/8in	13/16in	6mm	22mm	21mm
1840DLF	Keyed Different, 1-1/2in (38mm) Shackle clearance	4	24	1/4in	1-1/2in	13/16in	6mm	38mm	21mm
1840T	2-Pack of No. 1840 Keyed Alike	4	16	1/4in	7/8in	13/16in	6mm	22mm	21mm
1840Q	4-Pack of No. 1840 Keyed Alike	4	16	1/4in	7/8in	13/16in	6mm	22mm	21mm



No. 627D

- 13/16in (20mm) Dial Luggage Lock
- Set your own combination convenience
- Resettable to allow for a personalized combination

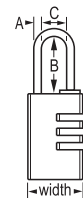

No. 627 Luggage Padlock

Product Number	Description	Shelf Pack Quantity	Master Carton Quantity	Shackle Dimensions			Shackle Dimensions (Metric)		
				A	B	C	A	B	C
1-3/16in (30mm) wide, Brass									
627D	Set Your Own Combination	4	24	3/16in	15/16in	9/16in	5mm	24mm	14mm

PLEASE SEE MASTER LOCK COMMERCIAL PRICE BOOK FOR KEYED ALIKE ITEMS

KEY BLANKS: See pages 67-69 for respective key blanks or cut key information.

RETAIL PRODUCTS AVAILABLE ONLY IN MASTER CARTON OR SHELF PACK QUANTITIES.



- Exact replacement blanks for genuine Master Lock keys
- Best choice for Universal Pin applications



Key Blanks

Commercial Boxed Products

Product Number	Description	Units (Per Box)
Pin Tumbler Type		
K1BOX	For Nos. 1, 2, 3, 4, 5, 6, 11, 34, 35, 36, 37, 39, 40, 238, 255, 311, 312, 315, 317, 380 430, 443, 475, 613, 1317, 1377, 1472, 1473, 1474, 1479, 1480, 1481, 1803, 1805, 2848, 2866, 3774, 8401, 8413 and 8423 locks and Pro Series® locks with W1 cylinder option	50
K1RSVBOX	For Nos. 1, 2, 3, 4, 5, 6, 11, 311, 312, 317, 430 and 443 locks and Pro-Series® locks with W1RSV cylinder option	50
K2BOX	For Master Lock 5-pin, W2K cylinders in Nos. 1, 2, 3, 4, 5, 6 and 11 locks	50
K7BOX	For Nos. 7, 8, 90, 97, 716, 719, 1807, 8417, 8418 and 8419 locks	50
K7RSVBOX	For Nos. 7 and 8 locks	50
K15BOX	For No. 15, 220, and 230 locks and Pro Series® locks with W15 cylinder option	50
K17BOX	For No. 17 locks and Pro Series® locks with W17 cylinder option	50
K27BOX	For Nos. 21, 24, 25, 27, 31, 101, 220 and 230 locks and Pro Series® locks with W27 cylinder option	50
K81BOX	For Nos. 81, 82, 530, 532, 533, 570, 571, 575, 576, 751, 991, 992, 996, 1710 and 1714 locks and Pro Series® locks with W81 cylinder option	50
K81KMBOX	For Nos. 81 & 82 locks and Pro-Series® locks with 5-pin W81KM cylinder option	50
K81RSVBOX	For Nos. 81, 82 locks and Pro-Series® locks with 5-pin W81RSV cylinder option	50
K120BOX	For Nos. 120, 121, 1820, 1825 and 4120 locks	50
K130BOX	For Nos. 130, 131, 132, 133, 134, 135, 136, 140, 141, 142, 143, 144, 145, 146, 372, 605, 614, 631, 635, 645, 1830, 1840, 4130 and 4140 locks	50
K150BOX	For Nos. 150, 151, 160, 373, 527, 590, 640 and 4150 locks	50
K600BOX	For Master Lock products only utilizing a 5-pin, W600A standard American Lock cylinder	50
K700BOX	For Master Lock products only utilizing a 6-pin, W700A standard American Lock cylinder	50
K900BOX	For Nos. 911, 930, 931 and 937 locks	50
K6000BOX	For Master Lock 5-pin, W6000 cylinders	50
K7000BOX	For Master Lock 6-pin, W7000 cylinders	50
K7000NISIBOX	For Master Lock 6-pin, W7000 cylinders, Nickel Silver	50
KWP6BOX	For 6-pin Nickel Silver, Edge® Key Control. <i>Please specify Dimple Pattern & Identification Code</i>	50
KWP4BOX	For 4-pin Nickel Silver, Edge® Key Control. <i>Please specify Dimple Pattern & Identification Code</i>	50
K8121BOX	For No. 8118 locks	25
Combination Change Key		
K175BAG	For Nos. 175, 176, 177 and 178 locks	10



- Specify key code when ordering

Duplicate Cut Keys

Description			Key			
Lock Models	Cylinders	Key Numbers	OBSOLETE Cut Key Product Number		Cut Key Product Number	Units / Package (Each)
			Cut Regular	Cut Master		
Pin Tumbler Cut Keys						
Nos. 1, 2, 187, 475, 1803 and 1805	W1	2001 - 2997 X2000 - X2998	K1CR	K1CM	K1	1
Nos. 3, 4, 11, 34, 35, 36, 37, 39, 40, 190, 311, 312, 315, 317, 430, 443, 631 and 1317	W1	0301 - 0950 3030 - 3999	K1CR	K1CM	K1	1
Nos. 5 and 6	W1	A101 - A2084	K1CR	K1CM	K1	1
Nos. 1MK2K, 2MK2K, 3MK2K, 4MK2K, 5MK2K, 6MK2K and 11MK2K	W2K	Customer Provided	N/A	K2CM	K2	1
Nos. 1RSV, 2RSV, 3RSV, 4RSV, 5RSV and 6RSV	W1RSV	1C001 - 2C367	K1CRRSV	K1RSVCM	K1RSV	1
Nos. 7, 8, 90, 176, 185, 189, 716, 719 and 1807	W7	P104 - P851 K1973 - K2924	K7CR	K7CM	K7	1
Nos. 7RSV and 8RSV	W7RSV	7P001 - 7P672	K7CRRSV	K7RSVCM	K7RSV	1
No. 15, 220, and 230	W15	10N001 - 19N950	K15CR	K15CM	K15	1
No. 17	W17	10T001 - 19T599	K17CR	K17CM	K17	1
Nos. 21, 24, 25, 27, 31 and 101	W27	10L001 - 19L616	K27CR	K27CM	K27	1
Nos. 81, 82, 530, 532, 533, 570, 571, 991, 992 and 996	W81	10R01 - 109R10	K81KRCR	K81KMCM	K81	1
Nos. 81RSV and 82RSV	W81RSV	10X01 - 109X10	K81CRRSV	K81RSVCM	K81RSV	1
	W81KM	Customer Provided	—	—	K81KM	1
Nos. 911, 930 and 931	W900	10Z001 - 19Z950	K900CR	K900CM	K900	1
Pro Series® 5-pin standard cylinders	W6000	10G001 - 34G157	K6000CR	K6000CM	K6000	1
Pro Series® 6-pin standard cylinders	W7000	400K001 - 594K569	K7000CR	K7000CM	K7000	1
American Lock® 5-pin standard cylinders	W600A	Random	K600ACR	K600ACM	K600A	1
American Lock® 6-pin standard cylinders	W700A	Random	K700ACR	K700ACM	K700A	1
Edge® Key Control Products 6-pin cylinders	WP6	400XX001 - 594XX569	KWP6CR	KWP6CM	KWP6	1
Edge® Key Control Products 4-pin cylinders	WP4	2001XX - 2997XX X2000XX - X2998XX	KWP4CR	KWP4CM	KWP4	1

NOTE: Please contact customer service for information on cut keys associated with the following products: 7113D, 7143D, 8118DPF, 8156DPS, 8157DPS, 8174DLWPF, 8184D, 8195D, 8195DLW, 8218DPS.

KEY BLANKS FOR PRO SERIES® PADLOCKS



K1 K15 K600A K700A



K900 K6000 K7000

- Exact replacement blanks for genuine Master Lock Pro Series® keys
- Solid brass blanks are easy to cut and resist corrosion
- Blanks for American W600A and W700A cylinders available



Key Blanks for Pro Series® Padlocks

Commercial Boxed Products

Product Number	Description	Units (Per Box)
Pro Series® Pin Tumbler		
K1BOX	For W1 Master Lock Cylinders	50
K15BOX	For W15 Master Lock Cylinders	50
K27BOX	For W27 Master Lock Cylinders	50
K81KRBOX	For W81KR Master Lock Cylinders	50
K81KMBOX	For W81KM Master Lock Cylinders	50
K600BOX	For W600A American 5-pin Cylinders	50
K6000BOX	For W6000 Master Lock Cylinders	50
K700BOX	For W700A American 6-pin Cylinders	50
K7000BOX	For W7000 Master Lock Cylinders	50
Interchangeable Core		
KCABOX	Interchangeable Core "A" Keyway	50
KCBBOX	Interchangeable Core "B" Keyway	50
KCCBOX	Interchangeable Core "C" Keyway	50
KCDBOX	Interchangeable Core "D" Keyway	50
KCEBOX	Interchangeable Core "E" Keyway	50
KCFBOX	Interchangeable Core "F" Keyway	50
KCGBOX	Interchangeable Core "G" Keyway	50
KCHBOX	Interchangeable Core "H" Keyway	50
KCJBOX	Interchangeable Core "J" Keyway	50
KCKBOX	Interchangeable Core "K" Keyway	50
KCLBOX	Interchangeable Core "L" Keyway	50
KCMBOX	Interchangeable Core "M" Keyway	50
KCQBOX	Interchangeable Core "Q" Keyway	50
KCWBOX	Interchangeable Core "W" Keyway	50
KCXBOX	Interchangeable Core "X" Keyway	50
KCYBOX	Interchangeable Core "Y" Keyway	50

Interested in more security products?

Explore Master Lock's wide range of innovative products across all categories. From commercial grade security to automotive security to door entry security, there's a solution for every customer need – at home, at work, or on the go.

COMMERCIAL SECURITY PRODUCTS

ProSeries® Rekeyable Padlocks, Weather Tough® Padlocks, ProSeries® Resettable Combination Padlocks, SafeSpace® Storage Security, Door Key Compatible Locks.



SAFETY SOLUTIONS PRODUCTS

Safety Padlocks, Lockout Devices, Safety Identification Signs and Tags.



DOOR HARDWARE PRODUCTS

Residential Door Hardware, Commercial Door Hardware, Multi-Family Door Hardware.



Effective November 15, 2019



Government Products

**AMERICAN
LOCK®**

**Master
Lock®**

Security Products Made To Meet Exacting U.S. Government Standards

MAKE-TO-ORDER CAPABILITY

SECURITY PRODUCTS BUILT AND KEYED TO YOUR REQUIREMENTS

- 1 SHACKLE OPTIONS**
Choose extra length shackles
- 2 KEYING FLEXIBILITY**
Over 60 padlock, door hardware and interchangeable core keyways available
Choose keying – KD, KA, MK, GMK
- 3 CHOOSE CUSTOM LASER ENGRAVING ON SOLID BRASS LOCKS**



EDGE® KEY CONTROL

Prevents unauthorized duplication of keys



ADVANCED CYLINDER TECHNOLOGY

Excellent protection against lock bumping



Table of Contents

Terms of Sale	3
Ordering Information	3
BumpStop®	4
Government Products	5
American Lock	
- Build Your Lock	6
- New NSN Listing	8
- Existing NSN Listing	9
Master Lock	
- Build Your Lock	10
- NSN Listing	11
- Resettable Combination Locks	13
- Key Cabinets	14
Service Parts	14

THE BUMP STOPS HERE!



Advanced Cylinder Technology



Reverse Rake
Tapered
Driver Pin



High
Performance
Spring

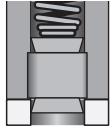

Precision
Cylinder
Chamber

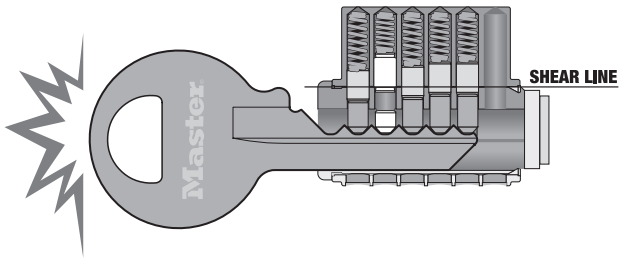

Lock Bumping –

Lock Bumping has become a legitimate security threat as information on the topic has become widely exposed in the news media and on the internet.

In response to this threat, The Master Lock Company developed exclusive patented BumpStop® Advanced Technology that hinders the transfer of force from the bump key to the pins and blocks rotation of the cylinder. With a reverse rake tapered driver pin, high performance spring and precision tolerance chamber, our 4, 5 and 6-pin BumpStop® products resist bump attacks.



BumpStop® is included in all American Lock and Master Lock Government security products - Made-to-order and NSNs, to meet CID requirements.



In addition, BumpStop is an upgrade available with most American Lock and Master Lock pin tumbler padlocks and security products.

Model Number Option: N

For over 60 years, American Lock and Master Lock, as prime contractors and subcontractors, have supplied every segment of D.D., Federal, State and Local Governments.

With unmatched lines of padlocks and portable security products, both American Lock and Master Lock padlocks are manufactured to exact Government CIDs and PIDs. Also, the exclusive BumpStop Advanced Cylinder Technology resists bump attacks.

American Lock has over 60 National Stock Numbers assigned to its product line to meet the most applications. Master Lock has more than 85 NSNs assigned to its product line. And through distribution Master Lock has in aggregate over 550 line items in GSA Advantage and 31 NSN line items referenced in D.D. Email. Master Lock also supplies product to AAFES, Navy, Marines and the U.S.Coast Guard.

If an NSN set doesn't exactly match a requirement, turn to the Make-to-Order capabilities of American Lock and Master Lock. Choose the precise quantity of padlocks with the specific shackle lengths, chain attachments and keying options needed. American Lock and Master Lock will manufacture the locks to match your requirements.

- Where required, American Lock and Master Lock products are designed to stringent government standards, CID-A-A-59486, CID-A-A-59487 and ASTM F883
- BumpStop® Advanced Cylinder Technology resists surreptitious attacks
- Make-to-Order capability – security products built and keyed to your requirements: shackle options, keying flexibility, laser engraving, key control and custom sets available
- 5-pin tumbler cylinder for added security
- More than 10,000 key changes available for maximum pick resistance
- Dual locking for superior pry resistance
- Most models are stamped "US"; sets are stamped "US SET"
- Non-removable keys for added security



A5200GLN, A5200GLSHN



6002NSBCUSS
& 6004NUS

ASL40NB



Rekeyable Solid Steel Government Padlocks

Example	A5200GLN KA
	A5200GLSHN KA
	A5200GLN MK W27

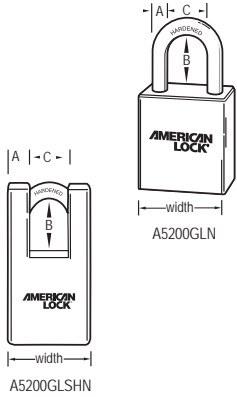

Base Model	Description
1-3/4in (44mm) Wide x 3/4in (19mm) Thick, Solid Steel Padlock with Hardened Boron Shackle, A = 5/16in (8mm), C = 3/4in (19mm), 5-pin Rekeyable W17 BumpStop® cylinder, Non-Removable Key, Lock Body Stamped "US".	
A5200GLN	B = 1-1/8in (28mm)
A5201GLN	B = 2in (50mm)
A5202GLN	B = 3in (75mm)
1-3/4in (44mm) Wide x 3/4in (19mm) Thick, Solid Steel Padlock with Shrouded Hardened Boron Shackle, A = 5/16in (8mm), C = 3/4in (19mm), 5-pin Rekeyable W17 BumpStop® cylinder, Non-Removable Key, Lock Body Stamped "US".	
A5200GLSHN	B = 1-1/8in (28mm)

Keying	Standard: Keyed Different
KA	Keyed Alike
MK	Keyed Different; Master Keyed (W27 BumpStop® cylinder)
KAMK	Keyed Alike; Master Keyed (W27 BumpStop® cylinder)

Cylinder	Standard: 5-pin W17 BumpStop® cylinder (Keyed Different and Keyed Alike only)
W27	Master Keyed. 5-pin BumpStop® cylinder Master Keyed and Master Keyed Alike Option

Custom Marking	
USS	Stamped "US Set"

Number of Keys	Standard: 2 keys per lock
1KEY	1 key per lock
3KEY	3 keys per lock
4KEY	4 keys per lock
NOKEY	0 keys per lock

Boxed Sets

Model Number	SKU	Description
1-3/4in (44mm) Wide x 3/4in (19mm) Thick Solid Steel Padlock with Hardened Boron Shackle, A = 5/16in (8mm), C = 3/4in (19mm), Rekeyable 5-pin BumpStop® cylinder, Lock Body Stamped "US SET".		
A5200GLNKAS6	111998	Set of 6 locks keyed alike
A5200GLNKAS10	P11246	Set of 10 locks keyed alike
A5200GLNKAS12	111999	Set of 12 locks keyed alike

Locks within a set are keyed alike. For orders with more than one set, each set has its own unique key, different from the next set. Include both the SKU number and model number when placing order.



Non-Rekeyable Solid Brass Government Padlocks

Example ASL42N KA



Base Model	Description
	1-1/2in (38mm) Wide x 3/4in (19mm) Thick, Solid Brass Padlock with Hardened Boron Shackle, A = 1/4in (6mm), C = 3/4in (19mm), 5-pin W17 BumpStop® cylinder, Non-Removable Key, Lock Body Height 1.695in, Lock Body Stamped "US".
ASL40N	B = 1in (25mm)
ASL42N	B = 3in (75mm)

Keying	Standard: Keyed Different
KA	Keyed Alike
MK	Keyed Different; Master Keyed (W27 BumpStop® cylinder)
KAMK	Keyed Alike; Master Keyed (W27 BumpStop® cylinder)

Cylinder	Standard: 5-pin W17 BumpStop® cylinder (Keyed Different and Keyed Alike only)
W27	Master Keyed. 5-pin BumpStop® cylinder Master Keyed and Master Keyed Alike Option

Custom Marking	
USS	Stamped "US Set"
LZ1	Laser engraved in 1 area
LZ2	Laser engraved in 2 areas
LZ3	Laser engraved in 3 areas
LZ4	Laser engraved in 4 areas

Number of Keys	Standard: 2 keys per lock
1KEY	1 key per lock
3KEY	3 keys per lock
4KEY	4 keys per lock
NOKEY	0 keys per lock



Previously, many National Stock Numbers (NSNs) were able to be satisfied by either a laminated or a solid body padlock based on their Commercial Item Description (CID). This often led to confusion due to a number of agencies or organizations that stipulated a particular "body type" as mandatory or preferred. In order to relieve this issue, the Defense Logistics Agency (DLA) has created and assigned new NSNs to only satisfy solid body padlocks. These NSNs became active in the Master Lock Government Products Price List and are listed below. Each of the new NSNs fully comply with the performance standards identified in CIDs AA59486 and AA59487. The only difference is the "body type."

For example, there are two (2) different NSNs for what was the 5340-00-158-3805. The 5340-00-158-3805 ONLY satisfies laminated body padlocks and the 5340-01-588-1036 ONLY satisfies solid body padlocks.

The Master Lock Company has partnered with LC Industries to have these American Lock® NSNs, page 8 only, listed on the federal procurement list. As a result, all orders for these items need to be sent to LC Industries directly.

Government Products

National Stock Number (NSN)	OLD National Stock Number (NSN)	Spec Number (CID)	Equivalent Commercial Model Number (for reference only)	Set Size	Master Keys	Grand Master Keys	Keys Per Set KS	Keying	Chain	Ordering Model Number
5340-01-588-1036	5340-00-158-3805	AA 59487-2SS	A5200GLN	1				Keyed Different	N	NSN015881036
5340-01-588-1010	5340-00-158-3807	AA 59487-2SCS	A5200GLWN	1				Keyed Different	Y	NSN015881010
5340-01-588-1031	5340-00-291-4204	AA 59486-11B100S	ASL40N MK B SBC W27 USS	100	2			Master Keyed	Y	NSN015881031
5340-01-588-1044	5340-00-291-4209	AA 59486-11B40S	ASL40N MK B SBC W27 USS	40	2			Master Keyed	Y	NSN015881044
5340-01-588-1063	5340-00-291-4210	AA 59486-11B50S	ASL40N MK B SBC W27 USS	50	2			Master Keyed	Y	NSN015881063
5340-01-588-1091	5340-00-291-4211	AA 59486-11B20S	ASL40N MK B SBC W27 USS	20	2			Master Keyed	Y	NSN015881091
5340-01-588-1563	5340-00-291-4212	AA 59486-11B30S	ASL40N MK B SBC W27 USS	30	2			Master Keyed	Y	NSN015881563
5340-01-588-1567	5340-00-291-4213	AA 59486-11B05S	ASL40N MK B SBC W27 USS	5	2			Master Keyed	Y	NSN015881567
5340-01-588-1582	5340-00-291-4214	AA 59486-11B10S	ASL40N MK B SBC W27 USS	10	2			Master Keyed	Y	NSN015881582
5340-01-588-1592	5340-00-292-0902	AA 59486-11B13050503S	ASL40N MK B SBC W27 USS (GRP 5-5-3)	13	6	2		Grand Master Keyed	Y	NSN015881592
5340-01-588-1596	5340-00-292-0904	AA 59486-11B30151005S	ASL40N MK B SBC W27 USS (GRP 15-10-5)	30	6	2		Grand Master Keyed	Y	NSN015881596
5340-01-588-1641	5340-00-292-0906	AA 59486-11B50202010S	ASL40N MK B SBC W27 USS (GRP 20-20-10)	50	6	2		Grand Master Keyed	Y	NSN015881641
5340-01-588-1646	5340-00-406-6496	AA 59486-21B55351010LS	A5560N MK B SBC NR LZ1 USS (GRP 35-10), A5562 N MK B SBC NR LZ1 USS (GRP 10)	55	6	2		Grand Master Keyed	Y	NSN015881646
5340-01-588-1652	5340-00-409-3246	AA 59486-11B301510L05S	ASL40N MK B SBC W27 USS (GRP 15-5), ASL42N MK B SBC W27 USS (GRP 10)	30	6	2		Grand Master Keyed	Y	NSN015881652
5340-01-588-1657	5340-00-421-9382	AA 59486-11B4020L1505S	ASL40N MK B SBC W27 USS (GRP 15-5), ASL42N MK B SBC W27 USS (GRP 20)	40	6	2		Grand Master Keyed	Y	NSN015881657
5340-01-588-1664	5340-00-409-3247	AA 59486-21B804520L15S	A5560N MK B SBC NR LZ1 USS (GRP 45-15), A5562N MK B SBC NR LZ1 USS (GRP 20)	80	6	2		Grand Master Keyed	Y	NSN015881664
5340-01-588-1676	5340-00-682-1505	AA 59486-1AB05S2E1S	ASL40N KA B SBC USS 1KEY 2 Extra Keys	5			2	Keyed Alike	Y	NSN015881676
5340-01-588-1709	5340-00-682-1645	AA 59487-1BLS	ASL42N B	1				Keyed Different	N	NSN015881709
5340-01-588-1687	5340-00-682-1506	AA 59486-21B80303020S	A5560N MK B SBC W27 NR LZ1 USS (GRP 30-30-20)	80	6	2		Grand Master Keyed	Y	NSN015881687
5340-01-588-1819	5340-00-682-1508	AA 59487-1BCS	ASL40N B SBC	1				Keyed Different	Y	NSN015881819
5340-01-588-1827	5340-00-838-5266	AA 59486-1AB10S2S	ASL40N KA B SBC USS NOKEY 2 Extra Keys	10			2	Keyed Alike	Y	NSN015881827
5340-01-588-1831	5340-00-838-5267	AA 59486-1AB20S2S	ASL40N KA B SBC USS NOKEY 2 Extra Keys	20			2	Keyed Alike	Y	NSN015881831
5340-01-588-1838	5340-00-838-5268	AA 59486-1AB30S3S	ASL40N KA B SBC USS NOKEY 3 Extra Keys	30			3	Keyed Alike	Y	NSN015881838
5340-01-588-1841	5340-00-838-5275	AA 59486-1AB100S10S	ASL40N KA B SBC USS NOKEY 10 Extra Keys	100			10	Keyed Alike	Y	NSN015881841
5340-01-588-1846	5340-00-912-4089	AA 59486-1AB06S3S	ASL40N KA B SBC USS NOKEY 3 Extra Keys	6			3	Keyed Alike	Y	NSN015881846
5340-01-588-1863	5340-01-004-5180	AA 59487-1BCLS	ASL42N B SBC	1				Keyed Different	Y	NSN015881863
5340-01-588-1891	5340-01-050-7059	AA 59486-1AB05S2S	ASL40N KA B SBC USS NOKEY 2 Extra Keys	5			2	Keyed Alike	Y	NSN015881891
5340-01-588-1895	5340-01-151-4203	AA 59486-1AB25S2E1S	ASL40N KA B SBC USS 1KEY 2 Extra Keys	25			2	Keyed Alike	Y	NSN015881895
5340-01-588-1905	5340-01-158-1998	AA59486-2AS01LE2S	A5202GLWN KA	1				Keyed Alike	Y	NSN015881905
5340-01-588-1911	5340-01-269-9345	AA 59486-1AB05LS2E1S	ASL42N KA B SBC USS 1KEY 2 Extra Keys	5			2	Keyed Alike	Y	NSN015881911
5340-01-588-1916	5340-01-408-8434	AA 59486-2IS01LS	A5202GLWN	1				Keyed Different	Y	NSN015881916
5340-01-588-1928	5340-01-408-8452	AA 59486-2AS10S0E2S	A5200GLWN KA USS	10				Keyed Alike	Y	NSN015881928
5340-01-588-1954	5340-01-437-0625	AA 59486-2AS06S0E2S	A5200GLWN KA USS	6				Keyed Alike	Y	NSN015881954
5340-01-588-1960	5340-01-437-0627	AA 59486-2AS24S48S	A5200GLWN KA USS NOKEY 48 Extra Keys	24			48	Keyed Alike	Y	NSN015881960
5340-01-611-8130	5340-01-437-0630	AA 59486-2AS06LS12S	A5202GLWN KA USS NOKEY 12 Extra Keys	6			12	Keyed Alike	Y	NSN016118130

For any NSN with a set size greater than 1, the orderable quantity for a set is 1. The list price is the same for any ordered set quantity.

*Equivalent Commercial Models may require ordering separately additional keys, master and grand master keys. KS=Keys per Set
Consult the current Government CID AA 59486 and AA 59487 before ordering.

**NSNs include Government labels when ordering by "Ordering Model Number"*

Continue to order these American Lock® NSNs, on page 9, from The Master Lock Company.

Government Products									
National Stock Number (NSN)	Spec Number (CID)	Equivalent Commercial Model Number (for reference only)	Set Size	Master Keys	Grand Master Keys	Keys Per Set KS	Keying	Chain	Ordering Model Number
5340-00-422-1612	N/A	ABKB Blank (Keys)					N/A	N	ABKB
5340-00-582-2741	AA 59487-1BS	ASL40N B	1				Keyed Different	N	NSN005822741
5340-01-314-2447	N/A	AK5 (box of 50)					N/A	N	AK5
5340-01-412-7004	ASTM F883	ASL40N B KA USS	6				Keyed Alike	N	NSN014127004
5340-01-629-2435	AA59486-1AB02LS2E2S	ASL42N KA B SBC USS 2KS	2			2	Keyed Alike	Y	ASL42NKA B SBC USS 2KS

For any NSN with a set size greater than 1, the orderable quantity for a set is 1. The list price is the same for any ordered set quantity.

*Equivalent Commercial Models may require ordering separately additional keys, master and grand master keys. KS=Keys per Set
Consult the current Government CID AA 59486 and AA 59487 before ordering.

****NSNs include Government labels when ordering by "Ordering Model Number"***



Non-Rekeyable Laminated Steel & Brass Government Padlocks

Example	6001N LF US
----------------	-------------

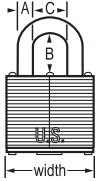

Base Model	Description
6001N	1-3/4in (44mm) wide laminated steel, hardened steel shackle, double ball locking, non-removable key, 5-pin W17 BumpStop® cylinder. Shackle dimensions: A=5/16in (8mm), C= 3/4in (19mm); must specify shackle height (B) LF or LT option.
6002N	1-3/4in (44mm) wide laminated brass, brass shackle, double ball locking, non-removable key, 5-pin W17 BumpStop® cylinder. Standard shackle dimensions: A=5/16in (8mm), B=3/4in (19mm), C= 3/4in (19mm)
6004N	1-9/16in (40mm) wide laminated brass, brass shackle, dual lever locking, non-removable key, 5-pin W17 BumpStop® cylinder. Standard shackle dimensions: A=9/32in (7mm), B=3/4in (19mm), C= 5/8in (16mm)

Keying	Standard: Keyed Different
KA	Keyed Alike
MK	Keyed Different; Master Keyed (W27 BumpStop® cylinder)
KAMK	Keyed Alike; Master Keyed (W27 BumpStop® cylinder)

Shackle	Standard: Brass, B = 3/4in (19mm) (only on 6002 & 6004)
LF	Hardened Steel, B=1-3/16in (30mm) (6001 option only)
LT	Hardened Steel, B=3in (76mm) (6001 option only)
BLJ	Brass, B = 2-5/8in (67mm), 5/16in (8mm) dia (6002 option only), B = 2-5/8in (67mm), 9/32in (7mm) dia (6004 option only)

Chain	Standard: 6001: Steel Chain; 6002 & 6004: Brass Chain
W	9in (229) Long, Zinc Plated Double Loop Chain and Shackle Collar, no holder (6001 option Only)

Cylinder	Standard: 5-pin W17 BumpStop® cylinder (Keyed Different and Keyed Alike only)
W27	Master Keyed. 5-pin BumpStop® cylinder Master Keyed and Master Keyed Alike Option

Custom Marking	
US	Stamped "US"
USS	Stamped "US SET"

Number of Keys	Standard: 2 keys per lock
1KEY	1 key per lock
3KEY	3 keys per lock
4KEY	4 keys per lock
NOKEY	0 keys per lock



Government Products

National Stock Number (NSN)	Spec Number (CID)	Equivalent Commercial Model Number (for reference only)	Set Size	Master Keys	Grand Master Keys	Keys Per Set KS	Keying	Chain	Ordering Model Number
4010-01-624-2087	N/A	85DPF	1				N/A	N	85DPF
5340-00-158-3805	AA 59487-2S	6001N LF US	1				Keyed Different	N	5340-00-158-3805
5340-00-158-3807	AA 59487-2SC	6001N LF W US	1				Keyed Different	Y	5340-00-158-3807
5340-00-291-4204	AA 59486-11B100	6004N MK SBC W27 USS	100	2			Master Keyed	Y	5340-00-291-4204
5340-00-291-4207	AA 59486-11B60	6004N MK SBC W27 USS	60	2			Master Keyed	Y	5340-00-291-4207
5340-00-291-4209	AA 59486-11B40	6004N MK SBC W27 USS	40	2			Master Keyed	Y	5340-00-291-4209
5340-00-291-4210	AA 59486-11B50	6004N MK SBC W27 USS	50	2			Master Keyed	Y	5340-00-291-4210
5340-00-291-4211	AA 59486-11B20	6004N MK SBC W27 USS	20	2			Master Keyed	Y	5340-00-291-4211
5340-00-291-4212	AA 59486-11B30	6004N MK SBC W27 USS	30	2			Master Keyed	Y	5340-00-291-4212
5340-00-291-4213	AA 59486-11B05	6004N MK SBC W27 USS	5	2			Master Keyed	Y	5340-00-291-4213
5340-00-291-4214	AA 59486-11B10	6004N MK SBC W27 USS	10	2			Master Keyed	Y	5340-00-291-4214
5340-00-292-0896	ASTM F883	179LH*	1				N/A	N	5340-00-292-0896
5340-00-292-0902	AA 59486-11B13050503	6004N MK SBC W27 USS (GRP 5-5-30)	13	6	2		Grand Master Keyed	Y	5340-00-292-0902
5340-00-292-0904	AA 59486-11B30151005	6004N MK SBC W27 USS (GRP 15-10-5)	30	6	2		Grand Master Keyed	Y	5340-00-292-0904
5340-00-292-0906	AA 59486-11B50202010	6004N MK SBC W27 USS (GRP 20-20-10)	50	6	2		Grand Master Keyed	Y	5340-00-292-0906
5340-00-406-6496	AA59486-21B55351010L	6002N MK SBC W27 USS (GRP 35-10), 6002N MK B LJ SBC W27 USS (GRP 10)	55	6	2		Grand Master Keyed	Y	5340-00-406-6496
5340-00-421-9382	AA 59486-11B4020L1505	6004N MK SBC W27 USS (GRP 15-5), 6004N MK B LJ SBC W27 USS (GRP 20)	40	6	2		Grand Master Keyed	Y	5340-00-421-9382
5340-00-473-5948	N/A	K7BOX	1 Box				N/A	N	K7BOX
5340-00-514-2782	ASTM F883	1500	1				N/A	N	5340-00-514-2782
5340-00-682-1505	AA 59486-1AB05S2E1	6004N KA SBC USS 1KEY 2 Extra Keys	5			2	Keyed Alike	Y	5340-00-682-1505
5340-00-682-1506	AA 59486-21B80303020	6002N MK SBC W27 USS (GRP 30-30-20)	80	6	2		Grand Master Keyed	Y	5340-00-682-1506
5340-00-682-1508	AA 59487-1BC	6004N SBC US	1				Keyed Different	Y	5340-00-682-1508
5340-00-682-1645	AA 59487-1BL	6004N LJ US	1				Keyed Different	N	5340-00-682-1645
5340-00-838-5266	AA 59486-1AB10S2	6004N KA SBC USS NOKEY 2 Extra Keys	10			2	Keyed Alike	Y	5340-00-838-5266
5340-00-838-5267	AA 59486-1AB20S2	6004N KA SBC USS NOKEY 2 Extra Keys	20			2	Keyed Alike	Y	5340-00-838-5267
5340-00-838-5268	AA 59486-1AB30S3	6004N KA SBC USS NOKEY 3 Extra Keys	30			3	Keyed Alike	Y	5340-00-838-5268
5340-00-838-5275	AA 59486-1AB100S10	6004N KA SBC USS NOKEY 10 Extra Keys	100			10	Keyed Alike	Y	5340-00-838-5275
5340-00-838-6986	AA 59486-1AB40S4	6004N KA SBC USS NOKEY 4 Extra Keys	40			4	Keyed Alike	Y	5340-00-838-6986
5340-00-838-6987	AA 59486-1AB50S5	6004N KA SBC USS NOKEY 5 Extra Keys	50			5	Keyed Alike	Y	5340-00-838-6987
5340-00-912-2364	N/A	1KALF 2004	1				Keyed Alike	N	5340-00-912-2364
5340-01-004-5180	AA 59487-1BCL	6004N LJ SBC US	1				Keyed Different	Y	5340-01-004-5180
5340-01-021-2619	N/A	7LF	1				Keyed Different	N	5340-01-021-2619
5340-01-050-7059	AA 59486-1AB05S2	6004N KA SBC USS NOKEY 2 Extra Keys	5			2	Keyed Alike	Y	5340-01-050-7059
5340-01-119-3981	AA 1928	175LH	1				N/A	N	5340-01-119-3981
5340-01-178-5983	AA 59486-21B15	6002N MK SBC W27 USS	15	2			Master Keyed	Y	5340-01-178-5983
5340-01-196-3056	N/A	140D	1				Keyed Different	N	5340-01-196-3056
5340-01-220-0160	N/A	703D (Hasp)	1				N/A	N	703D
5340-01-346-4611	ASTMF 883	1 LF BLK	1				Keyed Different	N	5340-01-346-4611
5340-01-346-4612	ASTMF 883	1 LF W BLK	1				Keyed Different	Y	5340-01-346-4612
5340-01-387-6639	N/A	1502	1				Combo Different	N	5340-01-387-6639
5340-01-408-8434	AA 59486-21S01L	6001N LT W US	1				Keyed Different	Y	5340-01-408-8434
5340-01-408-8450	AA 59486-21B01	6002N SBC US	1				Keyed Different	Y	5340-01-408-8450
5340-01-408-8452	AA 59486-2AS10S0E2	6001N KA LF W USS	10				Keyed Alike	Y	5340-01-408-8452
5340-01-437-0625	AA 59486-2AS06S0E2	6001N KA LF W USS	6				Keyed Alike	Y	5340-01-437-0625
5340-01-437-0627	AA 59486-2AS24S48	6001N KA LF W USS NOKEY 48KS Extra Keys	24			48	Keyed Alike	Y	5340-01-437-0627
5340-01-437-0630	AA 59486-2AS06LS12	6001N KA LT W USS NOKEY 12KS Extra Keys	6			12	Keyed Alike	Y	5340-01-437-0630
5340-01-468-5390	DWG 12422368	6001N KA LF Set of 2	2				Keyed Alike	N	5340-01-468-5390
5340-01-484-8654	AA 59486-1AB03S2	6004N KA SBC USS NOKEY 2 Extra Keys	3			2	Keyed Alike	Y	5340-01-484-8654
5340-01-494-4004	N/A	160D	1				Keyed Different	N	5340-01-494-4004
5340-01-499-8438	N/A	6121KA	1				Keyed Alike	N	5340-01-499-8438
5340-01-509-7800	N/A	1557	1				Combo Alike	N	5340-01-509-7800
5340-01-517-2237	N/A	410RED	1				Keyed Different	N	5340-01-517-2237
5340-01-539-0439	N/A	8LF	1				Keyed Different	N	5340-01-539-0439
5340-01-559-3127	N/A	6125 KA	1				Keyed Alike	N	5340-01-559-3127
5340-01-564-9809	N/A	8428DPS	1				Keyed Different	N	8428DPS
5340-01-567-7035	N/A	176	1				Keyed Different	N	176

* 179LH - Master Carton Quantity 25

Government Products

National Stock Number (NSN)	Spec Number (CID)	Equivalent Commercial Model Number (for reference only)	Set Size	Master Keys	Grand Master Keys	Keys Per Set KS	Keying	Chain	Ordering Model Number
5340-01-599-1736	N/A	1480KA	1				Keyed Alike	N	1480KA
5340-01-615-6465	N/A	178BLK	1				Keyed Different	N	178BLK
5340-01-617-2823	N/A	4130KA	1				Keyed Alike	N	4130KA
5340-01-645-2638	N/A	8KAB	1				Keyed Alike	N	8KAB
5925-01-647-8281	N/A	453XL	1				—	—	453XL
5930-LN-001-0595	N/A	496B	1				—	—	496B

For any NSN with a set size greater than 1, the orderable quantity for a set is 1. The list price is the same for any ordered set quantity.

*Equivalent Commercial Models may require ordering separately additional keys, master and grand master keys. KS=Keys per Set
Consult the current Government CID AA 59486 and AA 59487 before ordering.

**NSNs include Government labels when ordering by "Ordering Model Number"*



No. 175LH



No. 975



No. 1175



No. 1177



No. 1178

- Nos. 975, 975LH, 878 & 878LH are TAA Compliant
 - Shackle seal protects internal components from dirt and grime
 - Deadlocking mechanism protects against prying, shiming and rap attacks
- Nos. 1175, 1177 & 1178
 - Octagonal boron-carbide shackle for superior cut resistance
 - Shackle seal and dust cover protect internal components and dials for (not from) trouble-free operation
 - Deadlocking mechanism protects against prying, shiming and rap attacks
- All models
 - Set-your-own 4-digit combination for convenience and security
 - Reset to any of 10,000 possible personalized combinations

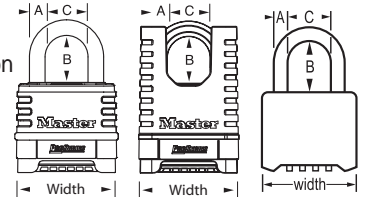

Resettable Combination Locks

Product Number	Description	Shelf Pack Quantity	Master Carton Quantity	Shackle Dimensions			Shackle Dimensions (Metric)		
				A	B	C	A	B	C
175	2in (51mm) wide Brass Body, with Round Hardened Steel Shackle	6	36	5/16in	1in	1in	8mm	25mm	25mm
175LH	2in (51mm) wide Brass Body, with Round Hardened Steel Shackle	6	36	5/16in	2-1/4in	1in	8mm	57mm	25mm
878	Set-Your-Own Combination; Black Powder Coated Zinc Body; NO Combination Reset Tool Required, TAA Compliant	6	36	5/16in	1in	1in	8mm	25mm	25mm
878LH	Set-Your-Own Combination; Black Powder Coated Zinc Body; 2-1/4in (57mm) Shackle; NO Combination Reset Tool Required, TAA Compliant	6	36	5/16in	2in	1in	8mm	51mm	25mm
975	Set-Your-Own Combination; NO Combination Reset Tool Required, TAA Compliant	6	36	5/16in	1in	1in	8mm	25mm	25mm
975LH	Set-Your-Own Combination; 2-1/4in (57mm) Shackle; No Combination Reset Tool Required, TAA Compliant	6	36	5/16in	2in	1in	8mm	51mm	25mm
1174	2-1/4in (57mm) wide Stainless Steel Body, with Round Stainless Steel Shackle	4	24	5/16in	1-1/16in	1in	8mm	28mm	25mm
1175	2-1/4in (57mm) wide Brass Body, with Octagonal Boron-Carbide Shackle	4	24	3/8in	1-1/16in	15/16in	10mm	28mm	24mm
1175LH	2-1/4in (57mm) wide Brass Body, with Octagonal Boron-Carbide Shackle	4	24	3/8in	2-1/16in	15/16in	10mm	53mm	24mm
1175LHSS	2-1/4in (57mm) wide Brass Body, with Round Stainless Steel Shackle	4	24	5/16in	2-1/16in	1in	8mm	53mm	25mm
1175RS	2-1/4in (57mm) wide Brass Body, with Round Stainless Steel Shackle	4	24	5/16in	1-1/16in	1in	8mm	28mm	25mm
1175LHRS	2-1/4in (57mm) wide Brass Body, with Round Stainless Steel Shackle	4	24	5/16in	2-1/16in	1in	8mm	53mm	25mm
1177	2-1/4in (57mm) wide Shrouded Brass Body, with Octagonal Boron-Carbide Shackle	4	24	3/8in	1-1/16in	1in	10mm	28mm	25mm
1178	2-1/4in (57mm) wide Die Cast Body, with Octagonal Boron-Carbide Shackle	4	24	3/8in	1-1/16in	15/16in	10mm	28mm	24mm



Nos. 175 and 975

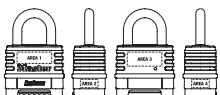

Nos. 1175, 1177 and 1178

Custom Marking

LZ1	Laser engraved in 1 area
LZ2	Laser engraved in 2 areas
LZ3	Laser engraved in 3 areas
LZ4	Laser engraved in 4 areas



No. 7126D



No. 7117D

- Heavy duty steel construction with full length, hinged door and built-in slotted key racks
- Durable, beige powder coated cabinet finish
- Rekeyable wafer cylinder lock that utilizes our K1 Key with improved pick resistance
- Key retaining security insures key cannot be removed until cabinet is locked
- 2 keys, key holders, cross reference chart and installation hardware included
- No. 7117 snap hook design fits slotted and key style key cabinets, boards, etc. for use with 7125D and 7126D

SAFESPACE® Heavy Duty Locking Key Cabinets *Boxed Products*

Product Number	Description	Master Carton Quantity
7125D	Heavy Duty Key Cabinet holds 60 keys. 12-1/4in (31.1cm) x 10-3/4in (27.3cm) x 3in (7.6cm)	4
7126D	Heavy Duty Key Cabinet holds 120 keys. 17in (43.2cm) x 13in (33cm) x 3-1/4in (8.3cm)	4
Plastic Key Hanger		
7117D	Plastic Key Holder; 20 holders per bag. 1-1/2in (38mm) x 1-2/3in (42mm) x 4/5in (20mm)	10 bags
7116D	Plastic Key Tags; 20 tags per bag. 1-1/4in (32mm) x 1-1/10in (28mm) x 1/2in (12mm)	10 bags

Service Parts American Lock®

Product Number	Description	Units Package Each	List Price (Each)
Padlock Cylinders			
APTC15NW17	5 Pin Bump Resistant Cylinder Keyed Different for Government GL Padlocks	1	
APT15NKAW17	5 Pin Bump Resistant Cylinder Keyed Alike for Government GL Padlocks	1	
APTC15NMKW27	5 Pin Bump Resistant Cylinder Master Keyed Keyed Different for Government GL Padlocks	1	
APT15NKAMKW27	5 Pin Bump Resistant Cylinder Master Keyed Keyed Alike for Government GL Padlocks	1	
Government Padlocks dated prior to July 12, 2010 require an actuator, p/n APKG0001670			
Actuator			
APKG0001670	Actuator, dead locking, for a A5200GL Series using a 5-pin Bump resistant cylinder, padlocks dated prior to July 12, 2010	6/pkg	
Cut Keys			
5 Pin Tumbler	AK27N Cut Master Key for W27 Bump Resistant Cylinder	1	
5 Pin Tumbler	AK17N Cut Standard Key for W17 Bump Resistant Cylinder	1	
Key Blanks			
BumpStop® Padlock Key Blanks			
AK5W17BOX	Key Blank, BumpStop®, 5-pin (W17 Cylinder), Keyed Different and Keyed Alike Only	50/Bx	
AK5W27BOX	Key Blank, BumpStop®, 5-pin (W27 Cylinder), Master Keyed Only	50/Bx	
Standard Padlock Key Blanks			
AK5BOX	Key Blank, Standard, 5-pin (APTC15 Cylinder) Non BumpStop®	50/Bx	

Service Parts Master Lock

Product Number	Description	Units Package Each	List Price (Each)
Cut Keys			
5 Pin Tumbler	K27N Cut Master Key for W27 Bump Resistant Cylinder	1	
5 Pin Tumbler	K17N Cut Standard Key for W17 Bump Resistant Cylinder	1	
Key Blanks			
BumpStop® Padlock Key Blanks			
K17BOX	Key Blank, BumpStop®, 5-pin (W17 Cylinder), Keyed Different and Keyed Alike Only	50/Bx	
K27BOX	Key Blank, BumpStop®, 5-pin (W27 Cylinder), Master Keyed and Keyed Alike Master Keyed Only	50/Bx	
Standard Padlock Key Blanks			
K81BOX	For Nos. 6001, 6002 and 6004 (W81 Cylinder) Non BumpStop®	50/Bx	

More From The Master Lock Company

AMERICAN LOCK® PRODUCTS

Solid Steel Padlocks, Solid Brass Padlocks, Solid Aluminum Padlocks, Edge® Key Control, BumpStop® Advanced Cylinder Technology.



COMMERCIAL SECURITY PRODUCTS

ProSeries® Rekeyable Padlocks, Weather Tough® Padlocks, ProSeries® Resettable Combination Padlocks, Safespace® Storage Security, Door Key Compatible and Interchangeable Core Locks, Hasps and Accessories, Edge® Key Control, BumpStop® Advanced Cylinder Technology.



SAFETY SOLUTIONS PRODUCTS

Safety Padlocks, Lockout Devices, Safety Identification Signs and Tags.



CONSUMER SECURITY RETAIL CARDED PRODUCTS

Laminated Padlocks, Brass Laminated Padlocks, Shrouded Padlocks, Solid Body Padlocks, Combination Padlocks, Carabiners, TSA Accepted Luggage Locks, Gun Locks.





Security Products

**AMERICAN
LOCK**

PRICE BOOK CONTENTS & EXPRESS PROGRAM

TERMS OF SALE	1
ORDERING INFORMATION.....	1
EXPRESS PROGRAM.....	2
SPEED INDEX	3
BUMPSTOP® ADVANCED CYLINDER TECHNOLOGY.....	5

COMMERCIAL PRODUCTS

■ Solid Steel Padlocks	6
■ Solid Stainless Steel Padlocks.....	14
■ Solid Brass Padlocks	16
■ Solid Aluminum Padlocks.....	22
■ Door Key Compatible Cylinders & Padlocks...	26
■ Interchangeable Cores & Padlocks.....	30
■ Combination Padlocks.....	36
■ Locking Bolt.....	36
■ Heavy Duty Hasps	37

MERCHANDISING.....	38
--------------------	----

GOVERNMENT LOCKS	39
------------------------	----

SERVICES

■ Padlock Keying Options	40
■ Keying Chart.....	40
■ Stainless Steel Pins	40
■ Special Powder Coating Finish	40
■ Custom Marking	41

SERVICE PARTS	42
---------------------	----

SPEED INDEX

Product Number	Page Number	Shelf Pack Quantity	Master Carton Quantity
A10	25	6	24
A11	25	6	24
A12	25	6	24
A20	20	6	24
A21	20	6	24
A22	20	6	24
A30	25	6	24
A31	25	6	24
A32	25	6	24
A40	20	6	24
A41	20	6	24
A42	20	6	24
A50	11	6	24
A50HS	11	6	24
A400K	36	—	25
A535	37	6	24
A700	8	6	24
A701	8	6	24
A702	8	6	24
A703	8	6	24
A706	8	6	24
A707	8	6	24
A800	37	—	12
A800LHC	7	—	6
A801	37	—	12
A801LHC	7	—	6
A802	37	—	6
A802LHC	7	—	6
A825	37	6	24
A850	37	6	24
A875	37	6	24
A885	37	6	24
A895	36	6	24
A1105 series	24	6	24
A1106 series	24	6	24
A1107 series	24	6	24
A1165 series	24	6	24
A1166 series	24	6	24
A1167 series	24	6	24
A1205 series	23	6	24
A1206 series	23	6	24
A1207 series	23	6	24
A1265 series	23	6	24
A1266 series	23	6	24
A1267 series	23	6	24
A1305 series	22	6	24
A1306 series	22	6	24

Product Number	Page Number	Shelf Pack Quantity	Master Carton Quantity
A1307 series	22	6	24
A1365 series	22	6	24
A1366 series	22	6	24
A1367 series	22	6	24
A1405WO series	35	6	24
A1406WO series	35	6	24
A1407WO series	35	6	24
A2010	7	—	12
A3105WO series	34	6	24
A3106WO series	34	6	24
A3107WO series	34	6	24
A3200WO series	31	6	24
A3201WO series	31	6	24
A3202WO series	31	6	24
A3260WO series	31	6	24
A3261WO series	31	6	24
A3262WO series	31	6	24
A3560WO series	33	6	24
A3561WO series	33	6	24
A3562WO series	33	6	24
A3570WO series	32	6	24
A3571WO series	32	6	24
A3572WO series	32	6	24
A3650WO series	27	6	24
A3651WO series	27	6	24
A3652WO series	27	6	24
A3655WO series	27	6	24
A3700WO series	28	6	24
A3701WO series	28	6	24
A3702WO series	28	6	24
A3800WO series	29	6	24
A3900SWO	35	6	24
A3901SWO	35	6	24
A3902SWO	35	6	24
A5100	10	6	24
A5101	10	6	24
A5102	10	6	24
A5200	10	6	24
A5201	10	6	24
A5202	10	6	24
A5260	10	6	24
A5261	10	6	24
A5262	10	6	24
A5300	9	6	24
A5360	9	6	24
A5400	15	6	24
A5401	15	6	24

NOTE: Speed Index does not include all products. See individual product pages for complete listing.

SPEED INDEX

Product Number	Page Number	Shelf Pack Quantity	Master Carton Quantity
A5461	15	6	24
A5530	19	6	24
A5531	19	6	24
A5532	19	6	24
A5560	18	6	24
A5561	18	6	24
A5562	18	6	24
A5570	17	6	24
A5571	17	6	24
A5572	17	6	24
A6100	10	6	24
A6101	10	6	24
A6102	10	6	24
A6200	10	6	24
A6201	10	6	24
A6202	10	6	24
A6260	10	6	24
A6261	10	6	24
A6300	9	6	24
A6360	9	6	24
A6530	19	6	24
A6531	19	6	24
A6532	19	6	24
A6560	18	6	24
A6561	18	6	24
A6562	18	6	24

Product Number	Page Number	Shelf Pack Quantity	Master Carton Quantity
A6571	17	6	24
A6572	17	6	24
A7200	12	6	24
A7201	12	6	24
A7202	12	6	24
A7260	12	6	24
A7261	12	6	24
A7262	12	6	24
A7300	12	6	24
ABTC1	42	—	1
AH10	13	6	24
AH11	13	6	24
AHTC2	42	—	1
AL50	21	6	24
AL51	21	6	24
AL52	21	6	24
ALLOCKSIGN	38	—	1
APTC12	42	—	1
APTC14	42	—	1
APT2001	42	—	1
APTW1	42	—	1
Government Locks	39		
Merchandising	38		
Service Parts	43-50		



Advanced Cylinder Technology



Reverse Rake
Tapered
Driver Pin



High
Performance
Spring

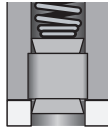

Precision
Cylinder
Chamber

Lock Bumping –

Lock Bumping has become a legitimate security threat as information on the topic has become widely exposed in the news media and on the internet.

In response to this threat, The Master Lock Company developed exclusive patent-pending BumpStop® Advanced Technology that prevents the transfer of force from the bump key to the pins and blocks rotation of the cylinder. With a reverse rake tapered driver pin, high performance spring and precision tolerance chamber, our 4, 5 and 6-pin BumpStop® products resist bump attacks.

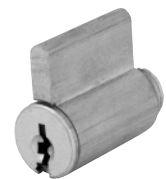
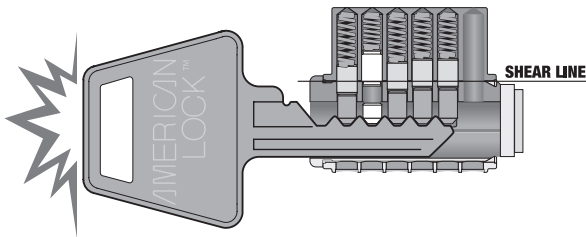

BumpStop® is available in a full range of American Lock padlocks and security products today!

Model Number Option: N

Rekeyable Hidden Shackle Padlocks

- Greatest physical security – defy bolt cutters and prying
- Rekeyable – replaceable cylinder and shackle
- 6-pin tumbler cylinders provide superior pick resistance with tens of thousands of key changes
- Hardened solid steel lockbody withstands forcible attacks
- Fasten hidden shackle padlock (A2010) to high security hasps (A801 & A802) for maximum security and convenience – A801LHC & A802LHC
- No. A802LHC can be used for overlapping doors



A2010

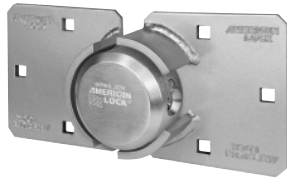

No. A800LHC

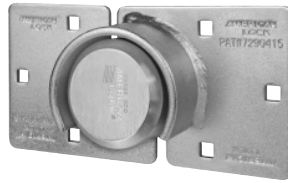

No. A801LHC

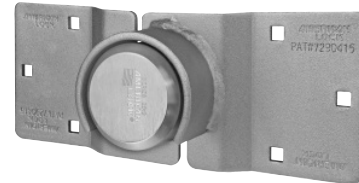

No. A802LHC

Solid Steel Padlocks

- Case hardened, chrome plated, solid steel bodies resist cutting, sawing and corrosion
- Hardened boron alloy shackles for superior cut resistance
- Dual ball bearing locking mechanism resists pulling and prying
- 5 & 6-pin cylinders are pick resistant with tens of thousands of key changes
 - Serrated pins are virtually impossible to pick
- Rekeyable – replaceable cylinder and shackle
- Shrouded shackles defy cutting and sawing – A5360 & A5300 Series
- Pick resistant, rekeyable 7 pin tubular cylinder provides over 50,000 key changes and meets NAMA standards – A7300, A7260 & A7200 Series
- Debris resistant, rekeyable cylinder performs extremely well in external applications – AH10 Series
- Non-rekeyable solid steel padlocks where padlock service is not necessary – A50 Series
- Fits Knaack® and Watchman® IV job boxes, stainless steel cylinder pins for increased drill resistance – A50HS



Nos. A5360 & A5300



No. A700



No. A7300



No. AH10

Rekeyable Padlocks — Hidden Shackle Products

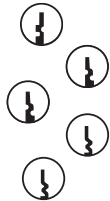
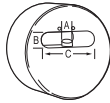

Example	A2010KA
Base Model	Description
A2010	2-7/8in (72mm) wide, Case Hardened, Chrome Plated, Solid Steel body, Boron Shackle, A = 3/8in (10mm), B = 19/32in (15mm), C = 1-23/32in (43mm), 6-pin APT2001 cylinder - Shelf Pack = NA, Master Carton = 12
A802LHC	High Security Hasp for overlapping doors (A802) fastened to Solid Steel lock body (A2010), Boron Shackle, A = 3/8in (10mm), B = 19/32in (15mm), C = 1-23/32in (43mm) - Shelf Pack = NA, Master Carton = 6
A801LHC	High Security Hasp (A801) fastened to Solid Steel lock body (A2010), Boron Shackle, A = 3/8in (10mm), B = 19/32in (15mm), C = 1-23/32in (43mm) - Shelf Pack = NA, Master Carton = 6
A800LHC	High Security Hasp (A800) and Solid Steel lock body (A2010), Boron Shackle, A = 3/8in (10mm), B = 19/32in (15mm), C = 1-23/32in (43mm) - Shelf Pack = NA, Master Carton = 6
BumpStop® Cylinder Technology	
N	Anti-Bump Cylinder Technology (<i>Not available with WO Option or UN & KZ Option</i>)
Keying	Standard: Keyed Different
UN	Uncombined (Zero bitted cylinder & no keys) - <i>Available with WP6 & WP4 options only</i>
KZ	Zero-Bitted (<i>Not Available with WP option</i>)
KA	Keyed Alike
MK	Keyed Different; Master Keyed
KAMK	Keyed Alike; Master Keyed
Cylinder	Standard: 6-pin APTC2001 cylinder
5PN	5-pin APTC12 cylinder
W6000	5-pin Master Lock W6000 cylinder
W7000	6-pin Master Lock W7000 cylinder
WP4	Edge® Key Control 4-pin cylinder. Standard: Nickel Silver Keys
WP6	Edge® Key Control 6-pin cylinder. Standard: Nickel Silver Keys
Number of Keys	Standard: 2 keys per lock
1KEY	1 key per lock
3KEY	3 keys per lock
4KEY	4 keys per lock
NOKEY	0 keys per lock

Rekeyable Padlocks — Solid Steel

Example		A700 KA NR
Base Model	Description	
2-1/2in (64mm) wide x 1-1/8in (28mm) Thick, Case Hardened, Chrome Plated, Solid Steel Padlock with Boron Shackle, A = 7/16in (11mm), C = 15/16in (24mm), 5-pin APTC12 cylinder		
A700	B = 1-1/16in (27mm)	
A701	B = 2in (51mm)	
2-1/2in (64mm) wide x 1-1/8in (28mm) Thick, Case Hardened, Chrome Plated, Solid Steel Padlock with Boron Shackle, A = 7/16in (11mm), C = 15/16in (24mm), 6-pin APTC14 cylinder		
A706	B = 1-1/16in (27mm)	
A707	B = 2in (51mm)	
2-1/2in (64mm) wide x 1-1/8in (28mm) Thick, Case Hardened, Zinc Plated, Solid Steel Padlock with Boron Shackle, A = 7/16in (11mm), C = 15/16in (24mm), 5-pin APTC12 cylinder		
A702	B = 1-1/16in (27mm)	
A703	B = 2in (51mm)	
BumpStop® Cylinder Technology		
N	Anti-Bump Cylinder Technology (Not available with WO Option or UN & KZ Option)	
Keying	Standard: Keyed Different	
UN	Uncombined (Zero bitted cylinder & no keys) - Available with WP6 & WP4 Options Only	
KZ	Zero-Bitted	
KA	Keyed Alike	
MK	Keyed Different; Master Keyed	
KAMK	Keyed Alike; Master Keyed	
Function	Standard: Non-Key Retaining	
NR	Non-Removable Key	
Cylinder		
WO	Lock without cylinder (A700, A701, A702 & A703 Option Only)	
6PN	6-pin APTC14 cylinder (A702 & A703 Option Only)	
WP4	Edge® Key Control 4-pin cylinder. Standard: Nickel Silver Keys (A700, A701, A702 & A703 Option Only)	
WP6	Edge® Key Control 6-pin cylinder. Standard: Nickel Silver Keys (A700, A701, A702 & A703 Option Only)	
Number of Keys	Standard: 2 keys per lock	
1KEY	1 key per lock	
3KEY	3 keys per lock	
4KEY	4 keys per lock	
NOKEY	0 keys per lock	

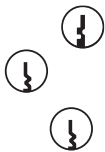

Rekeyable Padlocks — Shrouded Solid Steel

Example	A6360 KA WP6
----------------	--------------



Base Model	Description
A5360	2in (51mm) Wide x 3/4in (19mm) Thick, Case Hardened, Chrome Plated, Solid Steel Padlock with Boron Shackle, A = 3/8in (10mm), B = 1-1/8in (28mm), C = 3/4in (19mm), 5-pin APTC12 cylinder
A6360	2in (51mm) Wide x 3/4in (19mm) Thick, Case Hardened, Chrome Plated, Solid Steel Padlock with Boron Shackle, A = 3/8in (10mm), B = 1-1/8in (28mm), C = 3/4in (19mm), 6-pin APTC14 cylinder
A5300	1-3/4in (44mm) Wide x 3/4in (19mm) Thick, Case Hardened, Chrome Plated, Solid Steel Padlock with Boron Shackle, A = 5/16in (8mm), B = 1-1/8in (28mm), C = 3/4in (19mm), 5-pin APTC12 cylinder
A6300	1-3/4in (44mm) Wide x 3/4in (19mm) Thick, Case Hardened, Chrome Plated, Solid Steel Padlock with Boron Shackle, A = 5/16in (8mm), B = 1-1/8in (28mm), C = 3/4in (19mm), 6-pin APTC14 cylinder



BumpStop® Cylinder Technology	
N	Anti-Bump Cylinder Technology (Not available with WO Option or UN & KZ Option)

Keying	Standard: Keyed Different
UN	Uncombined (Zero bitted cylinder & no keys) - Available with WP6 & WP4 options only
KZ	Zero-Bitted (Not Available with WP option)
KA	Keyed Alike
MK	Keyed Different; Master Keyed
KAMK	Keyed Alike; Master Keyed

Function	Standard: Non-Key Retaining
NR	Non-Removable Key

Cylinder	
WO	Lock without cylinder (A5000 series Option Only)
WP4	Edge® Key Control 4-pin cylinder. Standard: Nickel Silver Keys (A5360 or A5300 Option Only)
WP6	Edge® Key Control 6-pin cylinder. Standard: Nickel Silver Keys (A5360 or A5300 Option Only)

Number of Keys	Standard: 2 keys per lock
1KEY	1 key per lock
3KEY	3 keys per lock
4KEY	4 keys per lock
NOKEY	0 keys per lock

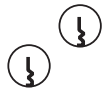

Rekeyable Padlocks — Solid Steel

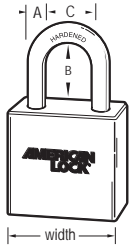

Example		A5202 KA 1KEY
Base Model	Description	
2in (51mm) Wide x 3/4in (19mm) Thick, Case Hardened, Chrome Plated, Solid Steel Padlock with Boron Shackle, A = 3/8in (10mm), C = 3/4in (19mm), 5-pin APTC12 cylinder		
A5260	B = 1-1/8in (28mm)	
A5261	B = 2in (51mm)	
A5262	B = 3in (75mm)	
2in (51mm) Wide x 3/4in (19mm) Thick, Case Hardened, Chrome Plated, Solid Steel Padlock with Boron Shackle, A = 3/8in (10mm), C = 3/4in (19mm), 6-pin APTC14 cylinder		
A6260	B = 1-1/8in (28mm)	
A6261	B = 2in (51mm)	
1-3/4in (44mm) Wide x 3/4in (19mm) Thick, Case Hardened, Chrome Plated, Solid Steel Padlock with Boron Shackle, A = 5/16in (8mm), C = 3/4in (19mm), 5-pin APTC12 cylinder		
A5200	B = 1-1/8in (28mm)	
A5201	B = 2in (51mm)	
A5202	B = 3in (75mm)	
1-3/4in (44mm) Wide x 3/4in (19mm) Thick, Case Hardened, Chrome Plated, Solid Steel Padlock with Boron Shackle, A = 5/16in (8mm), C = 3/4in (19mm), 6-pin APTC14 cylinder		
A6200	B = 1-1/8in (28mm)	
A6201	B = 2in (51mm)	
A6202	B = 3in (75mm)	
1-1/2in (38mm) Wide x 3/4in (19mm) Thick, Case Hardened, Chrome Plated, Solid Steel Padlock with Boron Shackle, A = 1/4in (6mm), C = 3/4in (19mm), 5-pin APTC12 cylinder		
A5100	B = 1in (25mm)	
A5101	B = 1-1/2in (38mm)	
A5102	B = 3in (75mm)	
1-1/2in (38mm) Wide x 3/4in (19mm) Thick, Case Hardened, Chrome Plated, Solid Steel Padlock with Boron Shackle, 6-pin APTC14 cylinder		
A6100	B = 1in (25mm)	
A6101	B = 1-1/2in (38mm)	
A6102	B = 3in (75mm)	



BumpStop® Cylinder Technology	
N	Anti-Bump Cylinder Technology (Not available with WO Option or UN & KZ Option)

Keying	Standard: Keyed Different
UN	Uncombined (Zero bitted cylinder & no keys) - Available with WP6 & WP4 Options Only
KZ	Zero-Bitted
KA	Keyed Alike
MK	Keyed Different; Master Keyed
KAMK	Keyed Alike; Master Keyed



Chain	
CN	#40 Sash Chain, 9in (229mm) Long, Zinc Plated

Function	Standard: Non-Key Retaining
NR	Non-Removable Key

Cylinder	
WO	Lock without cylinder (A5000 Series Option Only)
WP4	Edge® Key Control 4-pin cylinder. Standard: Nickel Silver Keys (A5000 series Option Only)
WP6	Edge® Key Control 6-pin cylinder. Standard: Nickel Silver Keys (A5000 series Option Only)

Number of Keys	Standard: 2 keys per lock
1KEY	1 key per lock
3KEY	3 keys per lock
4KEY	4 keys per lock
NOKEY	0 keys per lock



KEY BLANKS: See pages 43-44 for respective key blanks or cut key information.

★★ Unless otherwise specified, Shelf Pack = 6, Master Carton = 24 ★★

Non-Rekeyable Padlocks — Solid Steel

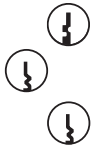

Example	A50 KA CN NR 1KEY
Base Model	Description
2in (51mm) Wide x 7/8in (22mm) Thick, Chrome Plated, Solid Steel Padlock with Boron Shackle, A = 3/8in (10mm), C = 3/4in (19mm), 5-pin APTC12 cylinder, Zinc Plated Boron Shackle	
A50HS	Stainless Steel pins, B = 1-1/8in (28mm) - Fits Knaack & Watchman IV job boxes
A50	B = 1-1/8in (28mm)
BumpStop® Cylinder Technology	
N	Anti-Bump Cylinder Technology (Not available with WO Option or UN & KZ Option)
Keying	Standard: Keyed Different
KA	Keyed Alike
MK	Keyed Different; Master Keyed
KAMK	Keyed Alike; Master Keyed
Chain	Standard: Keyed Different
CN	#40 Sash Chain, 9in (229mm) Long, Zinc Plated
Function	Standard: Non-Key Retaining
NR	Non-Removable Key
Cylinder	Standard: 5-pin APTC12 cylinder
6PN	6-pin APTC14 cylinder
WP4	Edge® Key Control 4-pin cylinder. Standard: Nickel Silver Keys (A50SS & A50 Option Only)
WP6	Edge® Key Control 6-pin cylinder. Standard: Nickel Silver Keys (A50SS & A50 Option Only)
Number of Keys	Standard: 2 keys per lock
1KEY	1 key per lock
3KEY	3 keys per lock
4KEY	4 keys per lock
NOKEY	0 keys per lock

Rekeyable Padlocks — Solid Steel — Tubular Cylinder

Example A7300 KA



Base Model Description

2-1/4in (57mm) Wide x 7/8in (22mm) Thick, Case Hardened, Chrome Plated, Solid Steel Padlock with Boron Shackle, A = 7/16in (11mm), C = 15/16in (24mm), 7-pin AHTC2 cylinder

A7300 B = 1-1/8in (28mm)

2in (51mm) Wide x 7/8in (22mm) Thick, Case Hardened, Chrome Plated, Solid Steel Padlock with Boron Shackle, A = 3/8in (10mm), C = 3/4in (19mm), 7-pin AHTC2 cylinder

A7260 B = 1-1/8in (28mm)

A7261 B = 2in (51mm)

A7262 B = 3in (75mm)

1-3/4in (44mm) Wide x 7/8in (22mm) Thick, Case Hardened, Chrome Plated, Solid Steel Padlock with Boron Shackle, A = 5/16in (8mm), C = 3/4in (19mm), 7-pin AHTC2 cylinder

A7200 B = 1-1/8in (28mm)

A7201 B = 2in (51mm)

A7202 B = 3in (75mm)

Keying Standard: Keyed Different

KA Keyed Alike

Chain

CN #40 Sash Chain, 9in (229mm) Long, Zinc Plated (A7260 or A7200 Series Option Only)

Function Standard: Non-Key Retaining

NR Non-Removable Key

Cylinder

WO Lock without cylinder

Number of Keys Standard: 2 keys per lock

1KEY 1 key per lock

3KEY 3 keys per lock

4KEY 4 keys per lock

NOKEY 0 keys per lock



Non-Rekeyable Padlocks — Solid Steel



Example	AH10 KA
Base Model	Description
	2in (51mm) Wide x 1in (25mm) Thick, Case Hardened, Chrome Plated, Solid Steel Padlock with Nickel Plated Boron Shackle, A = 7/16in (11mm), C = 3/4in (19mm)
AH10	Plated body, B = 1-1/16in (27mm)
AH11	Plated body, B = 2in (51mm)
Keying	Standard: Keyed Different
KA	Keyed Alike
Function	Standard: Non-Key Retaining
NR	Non-Removable Key
Cylinder	Standard: 10 Blade ABTC1 cylinder
WO	Lock without cylinder
Number of Keys	Standard: 2 keys per lock
1KEY	1 key per lock
3KEY	3 keys per lock
4KEY	4 keys per lock
NOKEY	0 keys per lock

Solid Stainless Steel Padlocks – Highest Corrosion Resistance with Strong Security

Solid Stainless Steel Padlocks

- Offers strong security and the highest resistance to harsh weather and caustic or salty conditions
- Exceeds ASTM Grade 6 requirements for padlock corrosion resistance, with stainless steel body, shackle, ball bearings, springs and trap door, and brass cylinder and actuator
- Offering the custom make-to-order options you've come to expect from American Lock, stainless steel padlocks come in 1-3/4in and 2in widths, with a choice of 1-1/8in or 2in shackle heights
- Stainless steel shackles with dual ball locking offer strong resistance to cutting, sawing and prying; serrated cylinder pins resist picking
- Designed to secure equipment and buildings in outdoor or corrosive environments, such as heavy-duty industrial or marine equipment and factories, and outdoor structures such as sheds, gates or other buildings
- Rekeyable, making them easy to service, with replaceable 5- and 6-pin cylinders that provide tens of thousands of key changes
- Optional upgrades include BumpStop® Advanced Cylinder Technology and Edge® Key Control
- Laser engrave company logo, employee name or key number



No. A5460



No. A5461

Rekeyable Padlocks — Solid Stainless Steel Padlocks

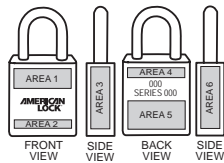

Example A6400 KA 1KEY

Base Model	Description
	2in (51mm) Wide x 3/4in (19mm) Thick, Solid Stainless Steel Padlock with Stainless Steel Shackle, A = 3/8in (10mm), C = 3/4in (19mm), 5-pin APTC12 cylinder
A5461	B = 2in (51mm)
	1-3/4in (44mm) Wide x 3/4in (19mm) Thick, Solid Stainless Steel Padlock with Stainless Steel Shackle, A = 5/16in (8mm), C = 3/4in (19mm), 5-pin APTC12 cylinder
A5400	B = 1-1/8in (28mm)
A5401	B = 2in (51mm)

BumpStop® Cylinder Technology

N	Anti-Bump Cylinder Technology (Not available with WO Option or UN & KZ Option)
---	--

Keying Standard: Keyed Different

UN	Uncombined (Zero bitted cylinder & no keys) - Available with WP6 & WP4 Options Only
KZ	Zero-Bitted
KA	Keyed Alike
MK	Keyed Different; Master Keyed
KAMK	Keyed Alike; Master Keyed

Chain

CN	#40 Sash Chain, 9in (229mm) Long, Zinc Plated, with Mounting Plate
----	--

Function Standard: Non-Key Retaining

NR	Non-Removable Key
----	-------------------

Cylinder

WO	Lock without cylinder (A5000 Series Option Only)
WP4	Edge® Key Control 4-pin cylinder. Standard: Nickel Silver Keys (A5000 series Option Only)
WP6	Edge® Key Control 6-pin cylinder. Standard: Nickel Silver Keys (A5000 series Option Only)

Custom Marking

LZ1	Laser engraved in 1 area
LZ2	Laser engraved in 2 areas
LZ3	Laser engraved in 3 areas
LZ4	Laser engraved in 4 areas
LZ5	Laser engraved in 5 areas
LZ6	Laser engraved in 6 areas

Number of Keys Standard: 2 keys per lock

1KEY	1 key per lock
3KEY	3 keys per lock
4KEY	4 keys per lock
NOKEY	0 keys per lock

Solid Brass Padlocks – Maximum Outdoor Security

Solid Brass Padlocks

- Solid brass bodies resist corrosion – ideal for harsh environments
- Hardened boron alloy shackles for superior cut resistance
- Dual ball bearing locking mechanism resists pulling and prying
- 5 & 6-pin cylinders are pick resistant with tens of thousands of key changes
 - Serrated pins are virtually impossible to pick
- Rekeyable – replaceable cylinder and shackle
- Debris resistant cylinder performs extremely well in external applications – AL50 Series
- Non-rekeyable solid brass padlocks where padlock service is not necessary – No. A20 & A40 Series



Solid Aluminum Padlocks – Maximum Outdoor Security

Solid Aluminum Padlocks

- Corrosion resistant solid aluminum – ideal for harsh environments
- Lightweight and spark resistant
- Variety of anodized finishes for easy identification
- Hardened boron alloy shackles for superior cut resistance
- Dual ball bearing locking mechanism resists pulling and prying
- 5 & 6-pin cylinders are pick resistant with tens of thousands of key changes
 - Serrated pins are virtually impossible to pick
- Rekeyable – replaceable cylinder and shackle
- Non-rekeyable solid aluminum padlocks where padlock service is not necessary – No. A10 & A30 Series

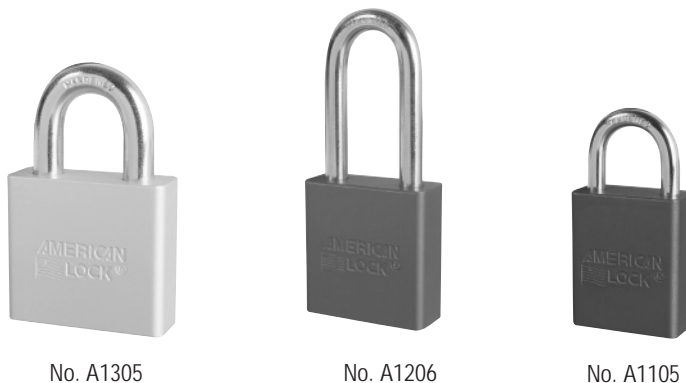

Rekeyable Padlocks — 2in (51mm) Solid Brass

Example A6572 MK CN



Base Model	Description
	2in (51mm) Wide x 3/4in (19mm) Thick, Solid Brass Padlock with Boron Shackle, A = 3/8in (10mm), C = 3/4in (19mm), 5-pin APTC12 cylinder
A5570	B = 1-1/8in (28mm)
A5571	B = 2in (51mm)
A5572	B = 3in (75mm)
	2in (51mm) Wide x 3/4in (19mm) Thick, Solid Brass Padlock with Boron Shackle, A = 3/8in (10mm), C = 3/4in (19mm), 6-pin APTC14 cylinder
A6571	B = 2in (51mm)
A6572	B = 3in (75mm)



BumpStop® Cylinder Technology

N	Anti-Bump Cylinder Technology <i>(Not available with WO & WCS Option or UN & KZ Option)</i>
---	---

Keying	Standard: Keyed Different
UN	Uncombined (Zero bitted cylinder & no keys) - <i>Available with WP6 & WP4 Options Only</i>
KZ	Zero-Bitted <i>(Not available with WP Option)</i>
KA	Keyed Alike
MK	Keyed Different; Master Keyed
KAMK	Keyed Alike; Master Keyed



Chain

CN	#40 Sash Chain, 9in (229mm) Long, Zinc Plated
----	---

Function **Standard: Non-Key Retaining**

NR	Non-Removable Key
----	-------------------



Cylinder

WO	Lock without cylinder <i>(A5000 Series Option Only)</i>
WP4	Edge® Key Control 4-pin cylinder. Standard: Nickel Silver Keys <i>(A5000 series Option Only)</i>
WP6	Edge® Key Control 6-pin cylinder. Standard: Nickel Silver Keys <i>(A5000 series Option Only)</i>

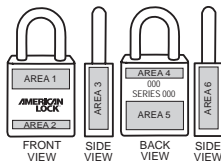

Custom Marking

LZ1	Laser engraved in 1 area
LZ2	Laser engraved in 2 areas
LZ3	Laser engraved in 3 areas
LZ4	Laser engraved in 4 areas
LZ5	Laser engraved in 5 areas
LZ6	Laser engraved in 6 areas

Number of Keys **Standard: 2 keys per lock**

1KEY	1 key per lock
3KEY	3 keys per lock
4KEY	4 keys per lock
NOKEY	0 keys per lock

Rekeyable Padlocks — 1-3/4in (44mm) Solid Brass

Example	A5561 NR
----------------	----------



Base Model	Description
	1-3/4in (44mm) Wide x 3/4in (19mm) Thick, Solid Brass Padlock with Boron Shackle, A = 5/16in (8mm), C = 3/4in (19mm), 5-pin APTC12 cylinder
A5560	B = 1-1/8in (28mm)
A5561	B = 2in (51mm)
A5562	B = 3in (75mm)
	1-3/4in (44mm) Wide x 3/4in (19mm) Thick, Solid Brass Padlock with Boron Shackle, A = 5/16in (8mm), C = 3/4in (19mm), 6-pin APTC14 cylinder
A6560	B = 1-1/8in (28mm)
A6561	B = 2in (51mm)
A6562	B = 3in (75mm)



BumpStop® Cylinder Technology	
N	Anti-Bump Cylinder Technology <i>(Not available with WO Option or UN & KZ Option)</i>

Keying	Standard: Keyed Different
UN	Uncombined (Zero bitting cylinder & no keys) - <i>Available with WP6 & WP4 Options Only</i>
KZ	Zero-Bitted <i>(Not available with WP Option)</i>
KA	Keyed Alike
MK	Keyed Different; Master Keyed
KAMK	Keyed Alike; Master Keyed



Chain	
CN	#40 Sash Chain with collar, 9in (229mm) Long, Zinc Plated

Function	Standard: Non-Key Retaining
NR	Non-Removable Key



Cylinder	
WO	Lock without cylinder <i>(A5000 Series Option Only)</i>
WP4	Edge® Key Control 4-pin cylinder. Standard: Nickel Silver Keys <i>(A6000 series Option Only)</i>
WP6	Edge® Key Control 6-pin cylinder. Standard: Nickel Silver Keys <i>(A6000 series Option Only)</i>

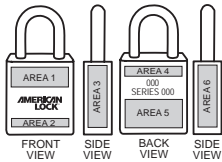

Custom Marking	
LZ1	Laser engraved in 1 area
LZ2	Laser engraved in 2 areas
LZ3	Laser engraved in 3 areas
LZ4	Laser engraved in 4 areas
LZ5	Laser engraved in 5 areas
LZ6	Laser engraved in 6 areas

Number of Keys	Standard: 2 keys per lock
1KEY	1 key per lock
3KEY	3 keys per lock
4KEY	4 keys per lock
NOKEY	0 keys per lock

Rekeyable Padlocks — 1-1/2in (38mm) Solid Brass

Example A5530 KAMK WP6



Base Model	Description
	1-1/2in (38mm) Wide x 3/4in (19mm) Thick, Solid Brass Padlock with Boron Shackle, A = 1/4in (6mm), C = 3/4in (19mm), 5-pin APTC12 cylinder
A5530	B = 1in (25mm)
A5531	B = 1-1/2in (38mm)
A5532	B = 3in (75mm)
	1-1/2in (38mm) Wide x 3/4in (19mm) Thick, Solid Brass Padlock with Boron Shackle, A = 1/4in (6mm), C = 3/4in (19mm), 6-pin APTC14 cylinder
A6530	B = 1in (25mm)
A6531	B = 1-1/2in (38mm)
A6532	B = 3in (75mm)



BumpStop® Cylinder Technology	
N	Anti-Bump Cylinder Technology (Not available with WO Option or UN & KZ Option)

Keying	Standard: Keyed Different
UN	Uncombined (Zero bitted cylinder & no keys) - Available with WP6 & WP4 Options Only
KZ	Zero-Bitted (Not available with WP Option)
KA	Keyed Alike
MK	Keyed Different; Master Keyed
KAMK	Keyed Alike; Master Keyed



Chain	
CN	#40 Sash Chain with collar, 9in (229mm) Long, Zinc Plated

Function	Standard: Non-Key Retaining
NR	Non-Removable Key

Cylinder	
WO	Lock without cylinder (A5000 Series Option Only)
WP4	Edge® Key Control 4-pin cylinder. Standard: Nickel Silver Keys (A5000 Series Option Only)
WP6	Edge® Key Control 6-pin cylinder. Standard: Nickel Silver Keys (A5000 Series Option Only)

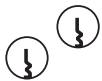

Custom Marking	
LZ1	Laser engraved in 1 area
LZ2	Laser engraved in 2 areas
LZ3	Laser engraved in 3 areas
LZ4	Laser engraved in 4 areas
LZ5	Laser engraved in 5 areas
LZ6	Laser engraved in 6 areas

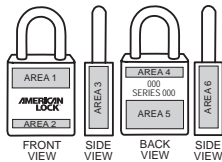

Number of Keys	Standard: 2 keys per lock
1KEY	1 key per lock
3KEY	3 keys per lock
4KEY	4 keys per lock
NOKEY	0 keys per lock

Non-Rekeyable Padlocks — Solid Brass

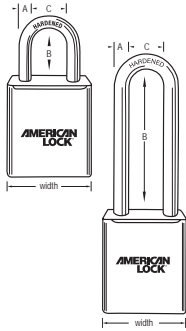

Example		A22 KA CN NR
Base Model	Description	
	1-3/4in (44mm) Wide x 3/4in (19mm) Thick, Solid Brass Padlock with Zinc Plated Boron Shackle, A = 5/16in (8mm), C = 3/4in (19mm), 5-pin APTC12 cylinder	
A20	B = 1-1/8in (28mm)	
A21	B = 2in (51mm)	
A22	B = 3in (75mm)	
	1-1/2in (38mm) Wide x 3/4in (19mm) Thick, Solid Brass Padlock with Zinc Plated Boron Shackle, A = 1/4in (6mm), C = 3/4in (19mm), 5-pin APTC12 cylinder	
A40	B = 1in (25mm)	
A41	B = 1-1/2in (38mm)	
A42	B = 3in (75mm)	



BumpStop® Cylinder Technology	
N	Anti-Bump Cylinder Technology (Not available with WO Option or UN & KZ Option)

Keying	Standard: Keyed Different
KA	Keyed Alike
MK	Keyed Different; Master Keyed
KAMK	Keyed Alike; Master Keyed



Chain	
CN	#40 Sash Chain, 9in (229mm) Long, Zinc Plated

Function	Standard: Non-Key Retaining
NR	Non-Removable Key

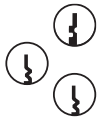

Cylinder	Standard: 5-pin APTC12 cylinder
6PN	6-pin APTC14 cylinder
WP4	Edge® Key Control 4-pin cylinder. Standard: Nickel Silver Keys
WP6	Edge® Key Control 6-pin cylinder. Standard: Nickel Silver Keys

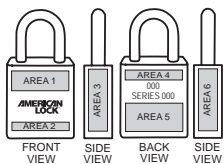

Custom Marking	
LZ1	Laser engraved in 1 area
LZ2	Laser engraved in 2 areas
LZ3	Laser engraved in 3 areas
LZ4	Laser engraved in 4 areas
LZ5	Laser engraved in 5 areas
LZ6	Laser engraved in 6 areas

Number of Keys	Standard: 2 keys per lock
1KEY	1 key per lock
3KEY	3 keys per lock
4KEY	4 keys per lock
NOKEY	0 keys per lock

Rekeyable Padlocks — Solid Brass — Blade Tumbler Cylinder

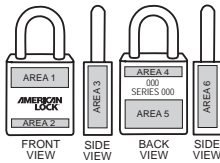

Example	AL52 KA
Base Model	Description
	1-3/4in (44mm) Wide x 3/4in (19mm) Thick, Solid Brass Padlock with Boron Shackle, A = 5/16in (8mm), C = 3/4in (19mm)
AL50	B = 1-1/8in (28mm)
AL51	B = 2in (51mm)
AL52	B = 3in (75mm)
Keying	Standard: Keyed Different
KA	Keyed Alike
Chain	Standard: Keyed Different
CN	#40 Sash Chain, 9in (229mm) Long, Zinc Plated
Function	Standard: Non-Key Retaining
NR	Non-Removable Key
Cylinder	Standard: 10 Blade ABTC1 cylinder
WO	Lock without cylinder
Custom Marking	
LZ1	Laser engraved in 1 area
LZ2	Laser engraved in 2 areas
LZ3	Laser engraved in 3 areas
LZ4	Laser engraved in 4 areas
LZ5	Laser engraved in 5 areas
LZ6	Laser engraved in 6 areas
Number of Keys	Standard: 2 keys per lock
1KEY	1 key per lock
3KEY	3 keys per lock
4KEY	4 keys per lock
NOKEY	0 keys per lock

Rekeyable Padlocks — 2in (51mm) Wide Solid Aluminum

Example A1305 RED



Base Model	Description
	2in (51mm) Wide x 3/4in (19mm) Thick, Solid Aluminum Padlock with Boron Shackle, A = 3/8in (10mm), C = 3/4in (19mm), 5-pin APTC12 cylinder
A1305	B = 1-1/8in (28mm)
A1306	B = 2in (51mm)
A1307	B = 3in (75mm)
	2in (51mm) Wide x 3/4in (19mm) Thick, Solid Aluminum Padlock with Boron Shackle, A = 3/8in (10mm), C = 3/4in (19mm), 6-pin APTC14 cylinder
A1365	B = 1-1/8in (28mm)
A1366	B = 2in (51mm)
A1367	B = 3in (75mm)



BumpStop® Cylinder Technology	
N	Anti-Bump Cylinder Technology (Not available with WO Option or UN & KZ Option)

Keying	Standard: Keyed Different
UN	Uncombined (Zero bitted cylinder & no keys) - Available with WP6 & WP4 Options Only
KZ	Zero-Bitted (Not available with WP Option)
KA	Keyed Alike
MK	Keyed Different; Master Keyed
KAMK	Keyed Alike; Master Keyed



Chain	Standard: #40 Sash Chain, 9in (229mm) Long, Zinc Plated
CN	

Function	Standard: Non-Key Retaining
NR	Non-Removable Key



Cylinder	Standard: 5-pin APTC12 cylinder
WO	Lock without cylinder (A1305 Series Option Only)
WP4	Edge® Key Control 4-pin cylinder. Standard: Nickel Silver Keys (A1300 Series Option Only)
WP6	Edge® Key Control 6-pin cylinder. Standard: Nickel Silver Keys (A1300 Series Option Only)

Lockbody Color	REQUIRED CHOICE (choose one)
BLK — Black; BLU — Blue; BRN — Brown; CLR — Clear; GRN — Green; ORJ — Orange; PRP — Purple; RED — Red; YLW — Yellow	

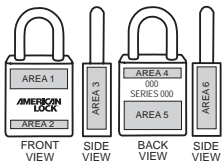

Custom Marking	Standard: Laser engraved in 1 area
LZ1	Laser engraved in 1 area
LZ2	Laser engraved in 2 areas
LZ3	Laser engraved in 3 areas
LZ4	Laser engraved in 4 areas
LZ5	Laser engraved in 5 areas
LZ6	Laser engraved in 6 areas

Number of Keys	Standard: 2 keys per lock
1KEY	1 key per lock
3KEY	3 keys per lock
4KEY	4 keys per lock
NOKEY	0 keys per lock

Rekeyable Padlocks — 1-3/4in (44mm) Wide Solid Aluminum

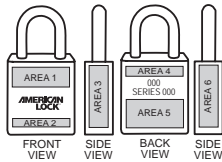
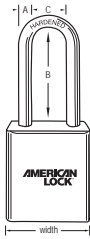

Example	A1205 CLR LZ2
Base Model	Description
1-3/4in (44mm) Wide x 3/4in (19mm) Thick, Solid Aluminum Padlock with Boron Shackle, A = 5/16in (8mm), C = 3/4in (19mm), 5-pin APTC12 cylinder	
A1205	B = 1-1/8in (28mm)
A1206	B = 2in (51mm)
A1207	B = 3in (75mm)
1-3/4in (44mm) Wide x 3/4in (19mm) Thick, Solid Aluminum Padlock with Boron Shackle, A = 5/16in (8mm), C = 3/4in (19mm), 6-pin APTC14 cylinder	
A1265	B = 1-1/8in (28mm)
A1266	B = 2in (51mm)
A1267	B = 3in (75mm)
BumpStop® Cylinder Technology	
N	Anti-Bump Cylinder Technology (Not available with WO Option or UN & KZ Option)
Keying Standard: Keyed Different	
UN	Uncombined (Zero bitted cylinder & no keys) - Available with WP6 & WP4 Options Only
KZ	Zero-Bitted (Not available with WP Option)
KA	Keyed Alike
MK	Keyed Different; Master Keyed
KAMK	Keyed Alike; Master Keyed
Chain	
CN	#40 Sash Chain, 9in (229mm) Long, Zinc Plated
Function Standard: Non-Key Retaining	
NR	Non-Removable Key
Cylinder	
WO	Lock without cylinder (A1205 Series Option Only)
WP4	Edge® Key Control 4-pin cylinder. Standard: Nickel Silver Keys (A1200Series Option Only)
WP6	Edge® Key Control 6-pin cylinder. Standard: Nickel Silver Keys (A1200 Series Option Only)
Lockbody Color REQUIRED CHOICE (choose one)	
BLK — Black; BLU — Blue; BRN — Brown; CLR — Clear; GRN — Green; ORJ — Orange; PRP — Purple; RED — Red; YLW — Yellow	
Custom Marking	
LZ1	Laser engraved in 1 area
LZ2	Laser engraved in 2 areas
LZ3	Laser engraved in 3 areas
LZ4	Laser engraved in 4 areas
LZ5	Laser engraved in 5 areas
LZ6	Laser engraved in 6 areas
Number of Keys Standard: 2 keys per lock	
1KEY	1 key per lock
3KEY	3 keys per lock
4KEY	4 keys per lock
NOKEY	0 keys per lock

Rekeyable Padlocks — 1-1/2in (38mm) Wide Solid Aluminum

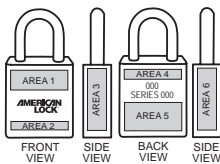
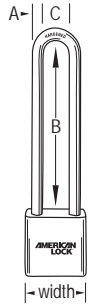

Example	A1105 KA CN NR BLU
Base Model	Description
1-1/2in (38mm) Wide x 3/4in (19mm) Thick, Solid Aluminum Padlock with Boron Shackle, A = 1/4in (6mm), C = 3/4in (19mm), 5-pin APTC12 cylinder	
A1105	B = 1in (25mm)
A1106	B = 1-1/2in (38mm)
A1107	B = 3in (75mm)
1-1/2in (38mm) Wide x 3/4in (19mm) Thick, Solid Aluminum Padlock with Boron Shackle, A = 1/4in (6mm), C = 3/4in (19mm), 6-pin APTC14 cylinder	
A1165	B = 1in (25mm)
A1166	B = 1-1/2in (38mm)
A1167	B = 3in (75mm)
BumpStop® Cylinder Technology	
N	Anti-Bump Cylinder Technology (Not available with WO Option or UN & KZ Option)
Keying	Standard: Keyed Different
UN	Uncombined (Zero bitted cylinder & no keys) - Available with WP6 & WP4 Options Only
KZ	Zero-Bitted (Not available with WP Option)
KA	Keyed Alike
MK	Keyed Different; Master Keyed
KAMK	Keyed Alike; Master Keyed
Chain	
CN	#40 Sash Chain, 9in (229mm) Long, Zinc Plated
Function	Standard: Non-Key Retaining
NR	Non-Removable Key
Cylinder	
WO	Lock without cylinder (A1105 Series Option Only)
W401	6 Pin. Reserved for Safety Lockout cylinder (Over 40,000 unique key numbers)
W417	Master Keyed. 6 Pin. Reserved for Safety Lockout cylinder
WP4	Edge® Key Control 4-pin cylinder. Standard: Nickel Silver Keys (A1100Series Option Only)
WP6	Edge® Key Control 6-pin cylinder. Standard: Nickel Silver Keys (A1100 Series Option Only)
Lockbody Color REQUIRED CHOICE (choose one)	
BLK — Black; BLU — Blue; BRN — Brown; CLR — Clear; GRN — Green; ORJ — Orange; PRP — Purple; RED — Red; YLW — Yellow	
Custom Marking	
LZ1	Laser engraved in 1 area
LZ2	Laser engraved in 2 areas
LZ3	Laser engraved in 3 areas
LZ4	Laser engraved in 4 areas
LZ5	Laser engraved in 5 areas
LZ6	Laser engraved in 6 areas
Number of Keys	Standard: 2 keys per lock
1KEY	1 key per lock
3KEY	3 keys per lock
4KEY	4 keys per lock
NOKEY	0 keys per lock

KEY BLANKS: See pages 43-44 for respective key blanks or cut key information.

★★ Unless otherwise specified, Shelf Pack = 6, Master Carton = 24 ★★

Non-Rekeyable Padlocks — Solid Aluminum

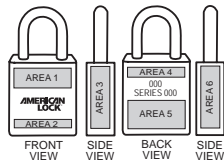
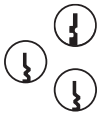

Example		A10 KA CSH LZ2
Base Model	Description	
1-3/4in (44mm) Wide x 3/4in (19mm) Thick, Solid Aluminum Padlock with Zinc Plated Boron Shackle, A = 5/16in (8mm), C = 3/4in (19mm), 5-pin APTC12 cylinder		
A10	B = 1-1/8in (28mm)	
A11	B = 2in (51mm)	
A12	B = 3in (75mm)	
1-1/2in (38mm) Wide x 3/4in (19mm) Thick, Solid Aluminum Padlock with Zinc Plated Boron Shackle, A = 1/4in (6mm), C = 3/4in (19mm), 5-pin APTC12 cylinder		
A30	B = 1in (25mm)	
A31	B = 1-1/2in (38mm)	
A32	B = 3in (75mm)	
BumpStop® Cylinder Technology		
N	Anti-Bump Cylinder Technology (Not available with WO or UN or KZ Option)	
Keying	Standard: Keyed Different	
KA	Keyed Alike	
MK	Keyed Different; Master Keyed	
KAMK	Keyed Alike; Master Keyed	
Shackle	Standard: Chrome Shackle (A10 Series Option Only)	
CSH	Chrome Shackle (A10 Series Option Only)	
Chain	Standard: #40 Sash Chain, 9in (229mm) Long, Zinc Plated, with Mounting Plate	
CN	#40 Sash Chain, 9in (229mm) Long, Zinc Plated, with Mounting Plate	
Function	Standard: Non-Key Retaining	
NR	Non-Removable Key	
Cylinder	Standard: 5-pin APTC12 cylinder	
6PN	6-pin APTC14 cylinder	
WP4	Edge® Key Control 4-pin cylinder. Standard: Nickel Silver Keys (A5000 series Option Only)	
WP6	Edge® Key Control 6-pin cylinder. Standard: Nickel Silver Keys (A5000 series Option Only)	
Custom Marking	Standard: Laser engraved in 1 area	
LZ1	Laser engraved in 1 area	
LZ2	Laser engraved in 2 areas	
LZ3	Laser engraved in 3 areas	
LZ4	Laser engraved in 4 areas	
LZ5	Laser engraved in 5 areas	
LZ6	Laser engraved in 6 areas	
Number of Keys	Standard: 2 keys per lock	
1KEY	1 key per lock	
3KEY	3 keys per lock	
4KEY	4 keys per lock	
NOKEY	0 keys per lock	

Door Key Compatible Cylinders and Padlocks

Same Key Can Open All Locks



- Use the same key that opens your security doors – Improve key control • Security • Convenience • Safety
- Cylinders may be ordered both as part of a complete American Lock® Door Key Compatible padlock assembly, or separately, keyed up and ready to plug into your system
- Padlock bodies will also accept the following OEM cylinders: Medeco® #20W20000 6-pin cylinder, Schlage® (6-pin Key-in-Knob), Assa® (65611), Schlage® Primus® & GMS® cylinders

Cylinder Options		
D12 Kwikset® (composite)	D04 Schlage® C	D03 Yale® 8

Door Key Compatible Padlocks

- Hardened boron alloy shackles for superior cut resistance defy bolt cutters and prying
- Dual ball bearing locking mechanism resists pulling and prying
- Rekeyable – replaceable cylinder and shackle

Solid Steel Padlocks

- Case hardened, chrome plated, solid steel bodies resist cutting, sawing and corrosion



No. A3800

Solid Brass Padlocks

- Solid brass bodies resist corrosion – ideal for harsh environments



No. A3650



No. A3701

Multi-Cylinder/Door Key Compatible Padlocks — Brass



Example	A3650 WO
	A3650 WO NDR
	A3650 D04 5 KA
	A3652 5PN

Base Model	Description
1-3/4in (44mm) Wide x 3/4in (19mm) Thick, Solid Brass Padlock with Boron Shackle, A = 5/16in (8mm), C = 15/16in (24mm)	
A3650	Boron, B = 1-1/8in (28mm)
A3651	Boron, B = 2in (51mm)
A3652	Boron, B = 3in (75mm)
A3655	Boron, B = 5in (127mm)

Chain	Description
CN	#40 Sash Chain, 9in (229mm) Long, Zinc Plated
SBC	#4 Double Loop Chain, 9in (229mm) Long, Solid Brass

Function	Standard: Non-Key Retaining
NR	Non-Removable Key

Cylinder	REQUIRED CHOICE				
WO	Lock without cylinder	6PN	American Lock 6-pin APTC14	W2K	Master Lock 4-pin W2K
D12	Kwikset® (composite)*	W6000	Master Lock 5-pin W6000	W27	Master Lock 5-pin W27
D04	Schlage® C	W7000	Master Lock 6-pin W7000	W81	Master Lock 5-pin W81
D03	Yale® 8	WP4	Edge® Key Control 4-pin	W1RSV	Master Lock 4-pin W1RSV
5PN	American Lock 5-pin APTC12	WP6	Edge® Key Control 6-pin	W81KM	Master Lock 5-pin W81KM
*Exclusively available as 5-pin cylinder		W1	Master Lock 4-pin W1	W81RSV	Master Lock 5-pin W81RSV

Note: 1) When ordering KIK door cylinders only, put an "A" prefix in front of the cylinder number to assure correct cylinder drivers.
 2) Cylinder Only Packaging: Shelf Pack = 6, Master Carton = 24

No. of Pins	Only for D03, D04, D28
5	5 pins
6	6 pins

Cylinder Driver	(Only for WO cylinder option) Standard: Schlage® / Loric® 1599 driver
NDR	No adaptor. No cylinder housing.
LR	Loric® 1539 driver
AB	Abus® 83 Series Cylinder Driver
MED	Medeco® KIK Cylinder Driver
AL6	American Lock APTC12/APTC14 Cylinder Driver (6PN, 5PN)
ML4	Master Lock 294 Cylinder Driver (W1, W2K, W1RSV, WP4)
ML5	Master Lock 295 Cylinder Driver (W15, W17, W27, W81, W81KM, W81RSV)
ML6	Master lock 296 Cylinder Driver (W6000, W7000, WP6)

Note: Except for NDR, driver option will include cylinder driver, key-retaining converter, cylinder housing (not AB), and housing screw.

Keying	Standard: Keyed Different
KZ	Zero-Bitted
KA	Keyed Alike
MK	Keyed Different; Master Keyed
KAMK	Keyed Alike; Master Keyed

Custom Marking	
LZ1	Laser engraved in 1 area
LZ2	Laser engraved in 2 areas
LZ3	Laser engraved in 3 areas
LZ4	Laser engraved in 4 areas
LZ5	Laser engraved in 5 areas
LZ6	Laser engraved in 6 areas

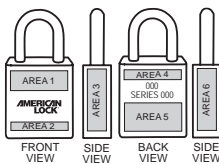

Number of Keys	Standard: 2 keys per lock
1KEY	1 key per lock
3KEY	3 keys per lock
4KEY	4 keys per lock
NOKEY	0 keys per lock

All marks are registered trademarks of their respective owners.

Door Key Compatible Cylinders & Padlocks — Brass

Example	A3702 D12 5 KA
	A D04 6
	A3700 WO



Base Model	Description
2in (51mm) Wide x 3/4in (19mm) Thick, Solid Brass Padlock with Boron Shackle, A = 3/8in (8mm), C = 3/4in (19mm)	
A3700	Boron, B = 1-1/8in (28mm)
A3701	Boron, B = 2in (51mm)
A3702	Boron, B = 3in (75mm)

Chain	
CN	#40 Sash Chain, 9in (229mm) Long, Zinc Plated



Function	Standard: Non-Key Retaining
NR	Non-Removable Key

Cylinder	
WO	Lock without cylinder
D12	Kwikset® (composite)*
D04	Schlage® C
D03	Yale® 8
*Exclusively available as 5-pin cylinder	
Note: 1) When ordering cylinders only, put an "A" prefix in front of the cylinder number to assure correct cylinder drivers are provided. 2) Cylinder Only Packaging: Shelf Pack = 6, Master Carton = 24	

No. of Pins	
5	5 Pins
6	6 Pins

Keying	Standard: Keyed Different
KZ	Zero-Bitted
KA	Keyed Alike
MK	Keyed Different; Master Keyed
KAMK	Keyed Alike; Master Keyed

Custom Marking	
LZ1	Laser engraved in 1 area
LZ2	Laser engraved in 2 areas
LZ3	Laser engraved in 3 areas
LZ4	Laser engraved in 4 areas
LZ5	Laser engraved in 5 areas
LZ6	Laser engraved in 6 areas

Number of Keys	Standard: 2 keys per lock
1KEY	1 key per lock
3KEY	3 keys per lock
4KEY	4 keys per lock
NOKEY	0 keys per lock

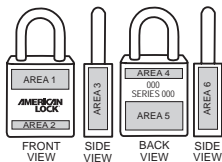

Door Key Compatible Cylinders & Padlocks — Steel



Example	A3800 D04 5 KAMK
	A D12 5 KZ
	A3800 WO
Base Model	Description
2-1/4in (57mm) Wide x 7/8in (19mm) Thick, Case Hardened, Chrome Plated, Solid Steel Padlock with Boron Shackle, A = 7/16in (11mm), C = 15/16in (24mm)	
A3800	Boron, B = 1-1/8in (28mm)
Function	Standard: Non-Key Retaining
NR	Non-Removable Key
Cylinder	
WO	Lock without cylinder
D12	Kwikset® (composite)*
D04	Schlage® C
D03	Yale® 8
*Exclusively available as 5-pin cylinder	
Note: 1) When ordering cylinders only, put an "A" prefix in front of the cylinder number to assure correct cylinder drivers are provided. 2) Cylinder Only Packaging: Shelf Pack = 6, Master Carton = 24	
No. of Pins	
5	5 Pins
6	6 Pins
Keying	Standard: Keyed Different
KZ	Zero-Bitted
KA	Keyed Alike
MK	Keyed Different; Master Keyed
KAMK	Keyed Alike; Master Keyed
Number of Keys	Standard: 2 keys per lock
1KEY	1 key per lock
3KEY	3 keys per lock
4KEY	4 keys per lock
NOKEY	0 keys per lock

Interchangeable Cores & Padlocks



- Padlock bodies will also accept the following standard size OEM cores: Best®, Best® PKS®, Arrow®, Falcon®, Kaba® Peaks®, KSP® & Lori®
- Cores may be ordered both as part of a complete American Lock IC padlock assembly, or separately, keyed up and ready to plug into your system

Interchangeable core keyways including Best® and Standard.



Interchangeable Core Padlocks

- Hardened boron alloy shackles for superior cut resistance
- Dual ball bearing locking mechanism resists pulling and prying
- Rekeyable – replaceable cylinder and shackle

SMALL FORMAT INTERCHANGEABLE CORE PADLOCKS

Solid Steel Padlocks

- Case hardened, chrome plated, solid steel bodies resist cutting, sawing and corrosion



No. A3200

Solid Brass Padlocks

- Solid brass bodies resist corrosion – ideal for harsh environments



No. A3560

Solid Aluminum Padlocks

- Corrosion resistant solid aluminum – ideal for harsh environments
 - Lightweight and spark resistant
- Variety of anodized finishes for easy identification



No. A3105RED

LARGE FORMAT INTERCHANGEABLE CORE PADLOCKS (Cores not available)

Solid Steel Padlocks

- Case hardened, chrome plated, solid steel bodies resist cutting, sawing and corrosion
- Accepts Schlage®, Everest® and Primus® Cores – A3900S Series



No. A3900S

Solid Aluminum Padlocks

- Corrosion resistant solid aluminum – ideal for harsh environments
 - Lightweight and spark resistant
- Variety of anodized finishes for easy identification
- Accepts Yale® 1220 core – No. A1405 Series



No. A1405RED

Small Format Interchangeable Cores & Padlocks — Solid Steel



Example	A3261 CY 7 04 KA
	CY 7 26D
	A3200 WO

Base Model	Description
2in (51mm) Wide x 3/4in (19mm) Thick, Case Hardened, Chrome Plated, Solid Steel Padlock with Boron Shackle, A = 3/8in (8mm), C = 3/4in (19mm)	
A3260	Boron, B = 1-1/8in (28mm)
A3261	Boron, B = 2in (51mm)
A3262	Boron, B = 3in (75mm)
1-3/4in (44mm) Wide x 3/4in (19mm) Thick, Case Hardened, Chrome Plated, Solid Steel Padlock with Boron Shackle, A = 5/16in (8mm), C = 3/4in (19mm)	
A3200	Boron, B = 1-1/8in (28mm)
A3201	Boron, B = 2in (51mm)
A3202	Boron, B = 3in (75mm)

Note: Control Keys Sold Separately

Chain	
CN	#40 Sash Chain, 9in (23cm) Long, Zinc Plated
Function	Standard: Non-Key Retaining
NR	Non-Removable Key

Cores	REQUIRED CHOICE
WO	Lock without cylinder
CY	Standard SFIC Keyway

Note: Core Only Packaging: Shelf Pack = 5, Master Carton = 20

No. of Pins	
6	6 Pins
7	7 Pins

Core Finish	
04	Satin Brass (Not available on 6-pin CM core)
26D	Satin Chrome

Keying	Standard: Keyed Different
UN	Uncombined (no keys)
KA	Keyed Alike
MK	Keyed Different; Master Keyed
KAMK	Keyed Alike; Master Keyed

Number of Keys	
1KEY	1 key per lock
3KEY	3 keys per lock
4KEY	4 keys per lock
NOKEY	0 keys per lock

Small Format Interchangeable Cores & Padlocks — 2in Solid Brass

Example	A3572 CY 6 26D
	CY 7 04
	A3572 WO



Base Model	Description
2in (51mm) Wide x 3/4in (19mm) Thick, Solid Brass Padlock with Boron Shackle, A = 3/8in (8mm), C = 3/4in (19mm)	
A3570	Boron, B = 1-1/8in (28mm)
A3571	Boron, B = 2in (51mm)
A3572	Boron, B = 3in (75mm)

Note: Control Keys Sold Separately



Chain	
CN	#40 Sash Chain, 9in (229mm) Long, Zinc Plated
Function	Standard: Non-Key Retaining
NR	Non-Removable Key

Cores	REQUIRED CHOICE
WO	Lock without cylinder
CY	Standard SFIC Keyway

Note: Core Only Packaging: Shelf Pack = 5, Master Carton = 20

No. of Pins	
6	6 Pins
7	7 Pins

Core Finish	
04	Satin Brass (Not available on 6-pin CM core)
26D	Satin Chrome

Keying	Standard: Keyed Different
UN	Uncombined (no keys)
KA	Keyed Alike
MK	Keyed Different; Master Keyed
KAMK	Keyed Alike; Master Keyed

Custom Marking	
LZ1	Laser engraved in 1 areas
LZ2	Laser engraved in 2 areas
LZ3	Laser engraved in 3 areas
LZ4	Laser engraved in 4 areas
LZ5	Laser engraved in 5 areas
LZ6	Laser engraved in 6 areas

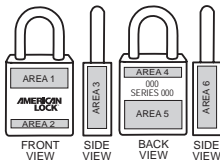

Number of Keys	
1KEY	1 key per lock
3KEY	3 keys per lock
4KEY	4 keys per lock
NOKEY	0 keys per lock

Small Format Interchangeable Cores & Padlocks — 1-3/4in Solid Brass



Example	A3562 CY 7 26D UN
	CY 6 04
	A3560 WO

Base Model	Description
1-3/4in (44mm) Wide x 3/4in (19mm) Thick, Solid Brass Padlock with Boron Shackle, A = 5/16in (8mm), C = 3/4in (19mm)	
A3560	Boron, B = 1-1/8in (28mm)
A3561	Boron, B = 2in (51mm)
A3562	Boron, B = 3in (75mm)

Note: Control Keys Sold Separately

Chain	
CN	#40 Sash Chain, 9in (229mm) Long, Zinc Plated

Function	Standard: Non-Key Retaining
NR	Non-Removable Key

Cores	REQUIRED CHOICE
WO	Lock without cylinder
CY	Standard SFIC Keyway

Note: Core Only Packaging: Shelf Pack = 5, Master Carton = 20

No. of Pins	
6	6 Pins
7	7 Pins

Core Finish	
04	Satin Brass (Not available on 6-pin CM core)
26D	Satin Chrome

Keying	Standard: Keyed Different
UN	Uncombined (no keys)
KA	Keyed Alike
MK	Keyed Different; Master Keyed
KAMK	Keyed Alike; Master Keyed

Custom Marking	
LZ1	Laser engraved in 1 areas
LZ2	Laser engraved in 2 areas
LZ3	Laser engraved in 3 areas
LZ4	Laser engraved in 4 areas
LZ5	Laser engraved in 5 areas
LZ6	Laser engraved in 6 areas

Number of Keys	
1KEY	1 key per lock
3KEY	3 keys per lock
4KEY	4 keys per lock
NOKEY	0 keys per lock

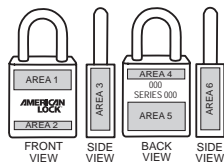

Small Format Interchangeable Cores & Padlocks — Aluminum

Example	A3105 CY 6 26D KA GRN
	CY 7 04
	A3107 WO



Base Model	Description
1-1/2in (38mm) Wide x 3/4in (19mm) Thick, Solid Aluminum Padlock with Boron Shackle, A = 1/4in (6mm), C = 3/4in (19mm)	
A3105	Boron, B = 1in (25mm)
A3106	Boron, B = 1-1/2in (38mm)
A3107	Boron, B = 3in (75mm)

Note: Control Keys Sold Separately

Chain	
CN	#40 Sash Chain, 9in (229mm) Long, Zinc Plated
Function	Standard: Non-Key Retaining
NR	Non-Removable Key

Cores	REQUIRED CHOICE
WO	Lock without cylinder
CY	Standard SFIC Keyway

Note: Core Only Packaging: Shelf Pack = 5, Master Carton = 20

No. of Pins	
6	6 Pins
7	7 Pins

Core Finish	
04	Satin Brass (Not available on 6-pin CM core)
26D	Satin Chrome

Keying	Standard: Keyed Different
UN	Uncombined (no keys)
KA	Keyed Alike
MK	Keyed Different; Master Keyed
KAMK	Keyed Alike; Master Keyed

Lockbody Color	REQUIRED CHOICE
BLK — Black; BLU — Blue; BRN — Brown; CLR — Clear; GRN — Green; ORJ — Orange; PRP — Purple; RED — Red; YLW — Yellow	

Custom Marking	
LZ1	Laser engraved in 1 areas
LZ2	Laser engraved in 2 areas
LZ3	Laser engraved in 3 areas
LZ4	Laser engraved in 4 areas
LZ5	Laser engraved in 5 areas
LZ6	Laser engraved in 6 areas

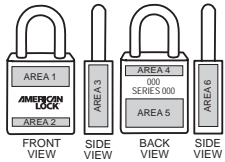

Number of Keys	
1KEY	1 key per lock
3KEY	3 keys per lock
4KEY	4 keys per lock
NOKEY	0 keys per lock

Large Format Interchangeable Core Padlocks — Solid Brass & Aluminum

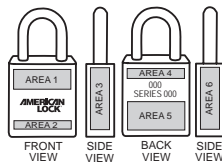

Example A1405 WO RED LZ4

Base Model	Description
	2in (51mm) Wide x 7/8in (22mm) Thick, Solid Brass Padlock, A = 3/8in (10mm), C = 3/4in (19mm)- Schlage® Everest® and Primus®
A3900S	Boron, B = 1-1/8in (28mm)
A3901S	Boron, B = 2in (51mm)
A3902S	Boron, B = 3in (75mm)
	1-3/4in (44mm) Wide x 7/8in (22mm) Thick, Solid Aluminum Padlock with Boron Shackle, A = 5/16in (8mm), C = 3/4in (19mm) - Yale® 1220
A1405	Boron, B = 1-1/8in (28mm)
A1406	Boron, B = 2in (51mm)
A1407	Boron, B = 3in (75mm)

Chain	
CN	#40 Sash Chain, 9in (229mm) Long, Zinc Plated

Function	Standard: Non-Key Retaining
NR	Non-Removable Key

Cores	REQUIRED CHOICE (Standard: WO without cylinder)
WO	Lock without cylinder

Lockbody Color	REQUIRED CHOICE for A1405 Series Only
BLK – Black; RED – Red; GRN – Green	

Custom Marking	
LZ1	Laser engraved in 1 area
LZ2	Laser engraved in 2 areas
LZ3	Laser engraved in 3 areas
LZ4	Laser engraved in 4 areas
LZ5	Laser engraved in 5 areas
LZ6	Laser engraved in 6 areas



- BlockGuard® Anti-Shim Technology withstands attempts to violate the latch mechanism
- 40-number dial with 3-number combination
- Automatic scrambler feature (automatically moves the dial upon closing the shackle for extra security)
- For use on lockers, bicycles, utility cabinets
- Available with key control access
- Available with blue, black, red and green dial

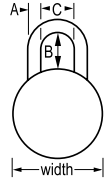

Combination Padlocks

Commercial Boxed Products

Product Number	Description	Master Carton Quantity	Shackle Dimensions			Shackle Dimensions (Metric)		
			A	B	C	A	B	C
2in (51mm) Diameter, 3-Number Combination Lock								
A400K	Stainless steel outer case; hardened steel shackle with key control feature	25	9/32in	3/4in	13/16in	7mm	19mm	21mm

Blue dial is standard. Please specify alternate dial color. BLK = BLACK / GRN = GREEN / RED = RED

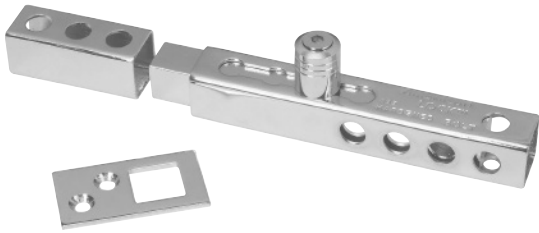

- 3/4in (18mm) hardened steel locking bolt for maximum strength
- Chrome plated for corrosion-resistance
- Fully adjustable from 3/4in to 2-3/8in (19mm-60mm)
- Mounting hardware included for easy installation

Locking Bolt

Commercial Boxed Products

Product Number	Description	Shelf Pack Quantity	Master Carton Quantity	Hasp Length	Accepts Shackle Dia. Up To:	Hasp Length (Metric)	Accepts Shackle Dia. (Metric) Up To:
3/4in (19mm) solid hardened steel throw							
A895	Steel Throw	6	24	8-1/2in	7/16in	216mm	11mm

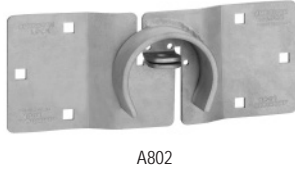
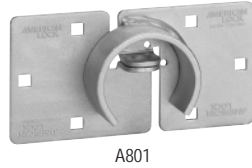
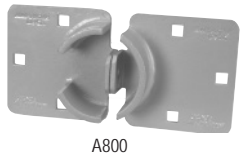

- Applications: trailers, van doors, garages, sheds, barns, storage buildings, vending machines, utility rooms and warehouse doors
- Hasps can be used with No. A2010 hidden shackle lock for maximum security
- Nos. A801 & A802 steel hasps can be mounted directly to A2010 hidden shackle locks for maximum security and convenience
- Trailer hasp secures overlapping doors — No. A802

High Security Hasps for Hidden Shackle Padlocks

Commercial Boxed Products

Product Number	Description	Shelf Pack Quantity	Master Carton Quantity	Hasp Length	Accepts Shackle Dia. Up To:	Hasp Length (Metric)	Accepts Shackle Dia. (Metric) Up To:
A800	Hidden Shackle Padlock Hasp	—	12	9-1/16in	9/16in	230mm	14mm
A801	Hidden Shackle Padlock Hasp – Fastens to Lock	—	12	8-3/4in	9/16in	222mm	14mm
A802	Hidden Shackle Padlock Trailer Hasp – Fastens to Lock	—	6	11-7/16in	9/16in	291mm	14mm



- Applications: trailers, van doors, garages, sheds, barns, storage buildings, vending machines, utility rooms and warehouse doors
- Hardened steel staple resists cutting, sawing and hammering
- Zinc plated hardened steel for added strength and weatherability
- Mounting hardware included for easy installation
- No. A850, A875 and A885 ideal for corners and angles

Heavy Duty Hasps

Commercial Boxed Products

Product Number	Description	Shelf Pack Quantity	Master Carton Quantity	Hasp Length	Accepts Shackle Dia. Up To:	Hasp Length (Metric)	Accepts Shackle Dia. (Metric) Up To:
A535	Centered Hole Hasp	6	24	5in	7/16in	127mm	11mm
A825	Straight Bar Hasp	6	24	7-1/4in	7/16in	184mm	11mm
A850	90 Degree Angle Bar Hasp	6	24	4-1/4in	7/16in	108mm	11mm
A875	Single Hinge Hasp	6	24	6-1/4in	7/16in	159mm	11mm
A885	Double Hinge Hasp	6	24	7-3/4in	7/16in	197mm	11mm

Commercial Product Display Panel

- Attractive Display generate impulse sales
- Customers are able to handle real products
- Illustrations and product feature copy help make selection easy

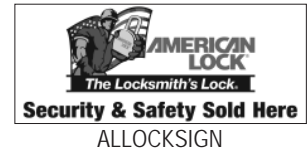

Commercial Products

Product Number	Description	Display Carton Quantity
Signs		
ALLOCKSIGN	American Lock® Security & Safety Sold Here; Header Sign, 24in x 10in	1

Government Locks

American Lock® has been known as The Locksmith's Lock with a padlock line offering unsurpassed quality and superior product performance. With over 90 years of precision machining and quality manufacturing, American Lock products exceed commercial industry standards in securing high-value property, withstanding extensive use and harsh environments, and defeating attempts to breach security at any level.

Protecting assets at facilities throughout the world, American Lock has delivered pride and workmanship through products such as our EDGE® key control product, and of course padlocks made to exact Government CIDs and PIDs. American Lock products are warranted for life and continue to offer quality, value and technical innovation.

For over 60 years, American Lock has provided security solutions to every segment of the U.S Government and military defense agencies. With our unmatched line of security products, American Lock has over 60 NSNs assigned to our product line to meet the most urgent of applications.

- Where required, American Lock products are designed to stringent government standards, CID-A-A-59486, CID-A-A-56487 and ASTM F883
- BumpStop® Advanced Cylinder Technology option provides excellent protection against bump attacks
- Make-to-order capability – security products built and keyed to your requirements: shackle options, keying flexibility, laser engraving, key control and custom sets available
- 5-pin tumbler cylinder for added security
- More than 10,000 key changes available for maximum pick resistance
- Dual locking for superior pry resistance
- Most models are stamped "US"; sets are stamped "US SET"
- Non-removable keys available for added security

A5200GL



A5560B



ASL40



Services

The services below are all available at an additional charge.
Please contact your American Lock representative for a quote.

PADLOCK KEYING OPTIONS

- **Keyed Different (KD)** - Each padlock has its own unique key. All products are made keyed different unless requested otherwise.
- **Keyed Alike (KA)** - Keyed alike is a term used to describe a set of padlocks which can be opened with the same key. Keyed alike offers convenience to customers who use numerous padlocks by eliminating multiple keys. Many domestically produced products are available keyed alike. (Padlocks and cylinders can also be keyed-alike in sets or groups.)
- **Master Key (MK)** - In a master key system, one key operates all the master keyed padlocks or cylinders in one or more groups.
- **Rekeyable** - Rekeying is the process of removing a padlock's cylinder and either rearranging the cylinder pins to different locations in the cylinder chamber or completely replacing the pins. Finished replacement cylinders are available from American Lock for a quick and easy rekeying process. The advantage of a padlock with a rekeyable cylinder is that when there is employee turnover or when a key is lost or stolen, the padlocks can be easily serviced rather than replaced. Many American Lock padlocks are available with this feature.
- **Restricted (R)** - American Lock offers restricted key systems with factory controlled keyways. This feature offers added security by restricting unauthorized key duplication.



- **Edge® Key Control (WP)** - American Lock offers patent-pending Edge® Key Control. The manufacturer is the only producer of key blanks. Key blanks and cut keys are strictly controlled by the manufacturer. (Patented cylinder and keys are protected by law from unauthorized duplication.)
- **Master W1, W15, W17, W27, W81** - Cylinders which are keyable to Master Lock® padlocks.
- **Non-Removable Key (NR)** - The key cannot be removed from the padlock when the padlock is open. This helps prevent users from accidentally leaving the padlock in the open position. Only selected padlocks offer this option.

KEY CHARTING

- Customers can benefit fully from the large American Lock change key ranges by having us chart your keying system for you. We will keep a complete record of the progressive key codes assigned and manufactured into your padlocks for each order. You will be assured that there is no unwanted key duplication with the padlocks you purchase over time. Be sure to request this special service with your next order so that all locks purchased from that point forward will be manufactured to comply with your key system requirements. Any orders placed by an end user or distributor should note that they are on a key charting system, or reference their End User I.D. Number.

STAINLESS STEEL PINS (SP)

- Stainless Steel pins can be recommended if a customer has an application that requires more drill resistant security such as a remote job site or high theft areas.
- Minimum order requirements: 500 pieces
- Lead time: 4-6 weeks

CHAIN AND TAG ATTACHMENTS

- Small chains may be attached to padlock shackles in order to affix padlocks to truck doors, gates, equipment, or other applications.
- Brass tags may be affixed to padlocks for identification purposes. These items are available separately. or can be attached at the factory.
- See page 55

SPECIAL POWDER COAT FINISHES

- American Lock Company can provide custom powder coated finishes in a variety of colors. The powder coat is a tough e-coat finish that is chip resistant.
- Minimum order requirements are 2500 pieces.
- Lead time ranges and costs will vary with the type of finish required, approximately 12-16 weeks for the first order.

Custom Marking

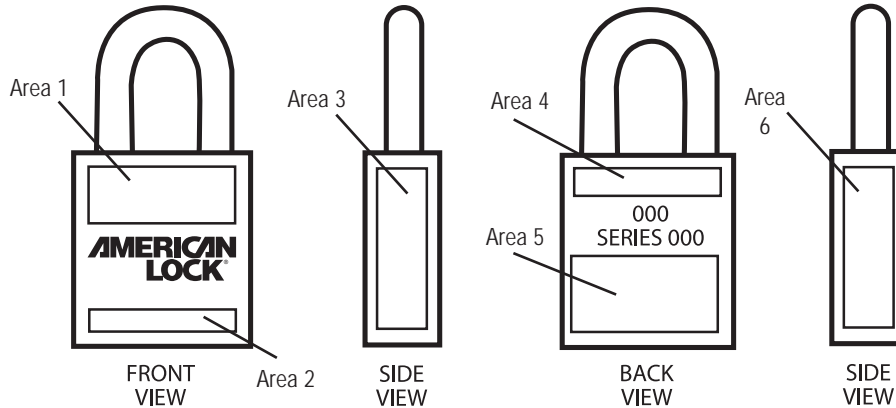

LASER ENGRAVING

- Laser Engraving (LZN, N=1-6) allows for easy identification of padlocks that is a permanent mark on the padlock that cannot be removed. Some applications are:
 - Safety Lock-out
 - Employee locker identification
 - Company logos for brand identification
- Six areas on an American Lock solid body aluminum and brass can be engraved for easy padlock identification.
- Numbers, letters, company logos, or alphanumeric characters can be added to a padlock.
- Logo engraving available in Area 1 & 5 only.
- There are a variety of type styles and sizes for text to choose from, or a customer can send a copy of their company logo and American Lock can permanently engrave it on a padlock.
- Not recommended for clear locks.
- Contact American Lock for order forms.

PAD PRINTING

- Custom pad printing is a great way for customers to personalize padlocks with an inexpensive, four color process. Candidates for this service are
 - Schools
 - Large institutions and manufacturing plants
 - Companies that want to increase brand awareness
- Companies can print logos, numbers, letters, or alphanumeric characters using a plastic resin paint that is fade and scratch resistant for five years.
- A logo can be made in up to four colors for easy identification with detail that can create magazine quality images.
- This process can be applied to any solid body padlock. Minimum order quantities are 1,000 pieces.
- Delivery of first order can take up to eight weeks.
- Contact American Lock for order forms and pricing.

OTHER

- **Custom Logo Stamping**
 - Companies can request custom logo stamping from American Lock.
 - For orders over 500 pieces, American Lock offers customer logo stamping on the padlock.
 - Costs vary for this type of service depending on the detail of the logo and padlock body.
 - Lead time: 10 - 12 weeks.
- **Other Stamping Options**

Key Stamping: Alpha numeric characters (HSK)*	
I.D. Tag	
Tag Stamping: Alpha numeric characters (HST)	
Interchangeable Core Stamping	Concealed Side of Cylinder (CKC)

*Note: Key Stamping: (HSK) Alpha numeric characters (Priced PER KEY)

Padlock Cylinders

Example	APTC12 UN WP6
Base Model	Description
APTC12	5-pin Cylinder for Series A700, A1000 & A6000 Padlocks - 1 unit/pkg, Shelf Pack = 12, Master Carton = 240
APTC14	6-pin Cylinder for Series A700, A1000 & A6000 Padlocks - 1 unit/pkg, Shelf Pack = 12, Master Carton = 240
APT2001	6-pin cylinder for Series A2000, A2001 & A2010 Padlocks - 1 unit/pkg, Shelf Pack = 6, Master Carton = 120
AHTC2	7-pin Tubular Cylinder for Series A7000. (Keyable to Ace®, Ace® II & Gem® Cylinders) - 1 unit/pkg, Shelf Pack = 12, Master Carton = 240
ABTC1	10 Blade Cylinder for Series AH10 and AL50 - 1 unit/pkg, Shelf Pack = 12, Master Carton = 240
APTW1	4-pin Master Lock® W1 Cylinder for Series A700, A1000 & A5000 Padlocks - 1 unit/pkg Shelf Pack = 12, Master Carton = 240



BumpStop® Cylinder Technology	
N	Anti-Bump Cylinder Technology (Available with APTC12, APTC14 & APT2001, Not available with UN & KZ option)

Keying	Standard: Keyed Different
UN	Uncombined (Zero Bitted cylinder with no keys) (Available with WP6 & WP4 option only)
KZ	Zero-Bitted (Not available with AHTC2 model or WP options)
KA	Keyed Alike
MK	Keyed Different; Master Keyed (Option available on APTC12, APTC14, APT2001, & APT748)
KAMK	Keyed Alike; Master Keyed

Keyway	
WR1	WR1 Restricted cylinder (not available with APT2001N)
WR2	WR2 Restricted cylinder
WR7	WR7 Restricted cylinder
WR8	WR8 Restricted cylinder
WP4	Edge® Key Control 4-pin cylinder. Standard: Nickel Silver Keys (APTC12 & APT2001 option only)
WP6	Edge® Key Control 6-pin cylinder. Standard: Nickel Silver Keys (APTC12 & APT2001 option only)

Note: For APT12 models using the Edge® Key Control cylinders, please order actuators (p. 53) and cover plates (p. 53) as needed. Reference Service Manual (A-004).

No. of Pins	
5PN	5 Pins (APT2001 option only)

Hard Stamp	
HSK	Hard Stamp Key

Number of Keys	Standard: 2 keys per lock
1KEY	1 key per lock
3KEY	3 keys per lock
4KEY	4 keys per lock
NOKEY	0 keys per lock

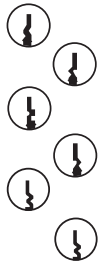



- Specify key code when ordering
- Edge® Key Control cut keys require End User information and dimple pattern

Duplicate Cut Keys

Description			Key			
Lock Models	Cylinders	Key Numbers	OBSOLETE Cut Key Product Number			Units / Package (Each)
			Cut Regular	Cut Master	Cut Key Product Number	
Pin Tumbler Cut Keys						
5-pin Tumbler, Standard Keyway	APTC12	11111 - 88888	APTKEY1	AMK1	AK5	1
6-pin Tumbler, Standard Keyway	APTC14, APT2001	111111 - 888888	APTKEY2	AMK2	AK6	1
5-pin Tumbler w/Restriction "R1"	APTC12	11111 - 88888	APTKEY11	AMK11	AK5WR1	1
6-pin Tumbler w/Restriction "R1"	APTC14	111111 - 888888	APTKEY21	AMK21	AK6WR1	1
5-pin Tumbler w/Restriction "R2"	APTC12	11111 - 88888	APTKEY12	AMK12	AK5WR2	1
6-pin Tumbler w/Restriction "R2"	APTC14	111111 - 888888	APTKEY22	AMK22	AK6WR2	1
5-pin Tumbler w/Restriction "R7"	APTC12	11111 - 88888	APTKEY17	AMK17	AK5WR7	1
6-pin Tumbler w/Restriction "R7"	APTC14	111111 - 888888	APTKEY27	AMK27	AK6WR7	1
5-pin Tumbler w/Restriction "R8"	APTC12	11111 - 88888	APTKEY18	AMK18	AK5WR8	1
6-pin Tumbler w/Restriction "R8"	APTC14	111111 - 888888	APTKEY28	AMK28	AK6WR8	1
6-pin Edge® Key Control	APTC12WP6	400XX001 - 594XX569	APTKEYWP6	AMKWP6	AKWP6	1
4-pin Edge® Key Control	APTC12WP4	2001XX - 2997XX X2000XX - X2998XX	APTKEYWP4	AMKWP4	AKWP4	1
4-pin Tumbler, Master Lock® 1K Keyway	APTW1	2001 - 2997	APTKEY1K	—	AK1	1
4-pin Tumbler, Master Lock® 27K Keyway	APTW27	10L001 - 19L616	—	—	AK27	1
4-pin Tumbler, Master Lock® 81K Keyway	APTW81	10R01 - 109R10	—	—	AK81	1
Blade Cut Keys						
Blade Standard	ABTC1	CD100 - CD724 CE100 - CE724	ABTKEYS	—	AKB	1
Blade w/Restricted Groove "A"	ABTC1	CD100 - CD724 CE100 - CE724	ABTKEYA	—	AKBWRA	1
Blade w/Restricted Groove "B"	ABTC1	CD100 - CD724 CE100 - CE724	ABTKEYB	—	AKBWRB	1
Blade w/Restricted Groove "C"	ABTC1	CD100 - CD724 CE100 - CE724	ABTKEYC	—	AKBWRC	1
Blade w/Restricted Groove "E"	ABTC1	CD100 - CD724 CE100 - CE724	ABTKEYE	—	AKBWRE	1
Tubular Cut Keys						
7-pin Tubular and Cam Lock	AHTC2	15001 - 57000	AHTKEYS	—	AKT	1
Key-In-Knob Duplicate Cut Keys (Please specify number when ordering)						
Kwikset® (composite) Key - 5 Pin	D12	12T1001 - 12T3422	KD12CR	KD12CM	KD125	1
Schlage® C Key - 5 Pin	D04	04T1001 - 04T9999	KD04CR	KD04CM	KD045	1
Schlage® C Key - 6 Pin	D04	04V10001 - 04V65536	KD04CR	KD04CM	KD046	1
Yale® 8 Key - 5 Pin	D03	03T1001 - 03T9999	KD03CR	KD03CM	KD035	1
Yale® 8 Key - 6 Pin	D03	03V10001 - 03V65536	KD03CR	KD03CM	KD036	1

*Letter from end user required. Please contact Customer Service for details.

Description			Key			
Lock Models	Cylinders	Key Numbers	OBSOLETE Cut Key Product Number			Units / Package (Each)
			Cut Regular	Cut Master	Control Keys	
Interchangeable Core: Duplicate Cut Keys & Control Keys						
Standard "Y" Keyway	CY	—	KCYCR	KCYCR	KCYCONTROLKEY	1

All marks are registered trademarks of their respective owners.

KEY BLANKS: See pages 43-44 for respective key blanks or cut key information.

★★ Unless otherwise specified, Shelf Pack = 6, Master Carton = 24 ★★

Key Blanks

■ Edge® Key Control key blanks require identification code and dimple pattern

Product Number	OBSOLETE Product Number	Description	Units/Package
Pin Tumbler Key Blanks			
AK5BOX	APKGPTKB1	Key Blank, Standard, 5-pin	50/pkg
AK6BOX	APKGPTKB2	Key Blank, Standard, 6-pin (APTC14, APT2001 cylinder)	50/pkg
AKWP6BOX	APKGPTKBWP6	Edge® Key Control 6-pin American Lock Key Blanks, Nickel Silver	50/pkg
AKWP4BOX	APKGPTKBWP4	Edge® Key Control 4-pin American Lock Key Blanks, Nickel Silver	50/pkg
AK5WR1KB	APTKB11	Key Blank, with Restriction "R1", 5-pin*	1 Each
AK6WR1KB	APTKB21	Key Blank, with Restriction "R1", 6-pin*	1 Each
AK5WR2KB	APTKB12	Key Blank, with Restriction "R2", 5-pin*	1 Each
AK6WR2KB	APTKB22	Key Blank, with Restriction "R2", 6-pin*	1 Each
AK5WR7KB	APTKB17	Key Blank, with Restriction "R7", 5-pin*	1 Each
AK6WR7KB	APTKB27	Key Blank, with Restriction "R7", 6-pin*	1 Each
AK5WR8KB	APTKB18	Key Blank, with Restriction "R8", 5-pin*	1 Each
AK6WR8KB	APTKB28	Key Blank, with Restriction "R8", 6-pin*	1 Each
Blade Key Blanks			
AKBBOX	APKGBKB	Key Blank, Blade, Standard	50/pkg
AKBWRAKB	ABKBA	Key Blank, Blade with Restricted Groove "A"	1 Each
AKBWRBKB	ABKBB	Key Blank, Blade with Restricted Groove "B"	1 Each
AKBWRCKB	ABKBC	Key Blank, Blade with Restricted Groove "C"	1 Each
AKBWREKB	ABKBE	Key Blank, Blade with Restricted Groove "E"	1 Each
Tubular Key Blanks			
AKTBOX	APKGHTKB7	Key Blank, Tubular, 7-pin	25/pkg
Small Format Interchangeable Core Key Blanks			
KCYBOX	—	Standard "Y" Keyway	50

*Letter of authorization from end user required.

Rekeying Parts

Product Number	Description	Units/Package
Pins		
Bottom Pins		
APKG3682010	Pin, Bottom #1	100/Pkg
APKG3682020	Pin, Bottom #2	100/Pkg
APKG3682030	Pin, Bottom #3	100/Pkg
APKG3682090	Pin, Bottom #4	100/Pkg
APKG3682050	Pin, Bottom #5	100/Pkg
APKG3682060	Pin, Bottom #6	100/Pkg
APKG3682070	Pin, Bottom #7	100/Pkg
APKG3682080	Pin, Bottom #8	100/Pkg
Top Pins		
APKG3664010	Pin, Top, Serrated	100/Pkg
APKG3653010	Pin, Top	100/Pkg
APKG3653020	Pin, Top (Stainless Steel)	100/Pkg
Master Pins		
APKG3681050	Pin, Master #2	100/Pkg
APKG3681010	Pin, Master #3	100/Pkg
APKG3681020	Pin, Master #4	100/Pkg
APKG3681030	Pin, Master #5	100/Pkg
APKG3681040	Pin, Master #6	100/Pkg
APKG3681070	Pin, Master #7	100/Pkg
Disc Tumbler Cylinder Parts		
APKG3501010	Blade, Tumbler, For Nos. AH10 & AL50 series locks	100/Pkg
APKG3680030	Pin, Retention, Cylinder, For No. AH10 series locks	100/Pkg
APKG3680110	Pin, Retention, Cylinder, For No. AL50 series locks	100/Pkg
APKG3601010	Spring inVin, Cylinder, For Nos. AH10 & AL50 series locks	100/Pkg
Spring		
APKG3054010	Spring, Tumbler	100/Pkg
Cylinder Clips		
0296-0324	Edge® Cylinder E Clip, For No. APTC12WP	12/Pkg
Cylinder Housing		
APKG3023010	Housing, Cylinder Adapter, For No. A2010	3/Pkg
APKG3013010	Housing, Cylinder Adapter, For Nos. A3600 & A3700 series locks	3/Pkg
APKG0000431	Housing, Cylinder Adapter, For No. A2000	3/Pkg
APKGP32953	Housing, KIK Cylinder Adapter, For A3650 Series	3/Pkg
APKGP32952	Housing, Padlock Cylinder Adapter, For A3650 Series	3/Pkg
APKG3014020	Housing, Cylinder Adapter, For No. A3800 series locks	3/Pkg
Miscellaneous Cylinder Parts		
APKG3017010	Bypass Restriction Plate	10/pkg
0296-0200	Ball Bearings, 3/32in Diameter, For AM100, AR100 & AD200 series Edge® cylinders	200/pkg

Rekeying Parts *(continued)*

Product Number	Description	Units/Package
Ball Bearings		
APKG1806010	Stainless Steel, 1/4in (6mm) Diameter, For Nos. A1105, A1205, A1305, A3600, A3700, A3260, A3200, A3560, A3570, A5100, A5200, A5260, A5300, A5360, A5530, A5560, A5570, A7200, A7260 & A7260 series locks	12/Pkg
APKG1807020	Stainless Steel, 5/16in (11mm) Diameter, For A780, A784 & A7300 series locks	12/Pkg
APKG0220-1007	Stainless Steel, 5/16in (8mm) Diameter, For A3650 Series locks	12/Pkg
APKG1809010	Stainless Steel, 3/8in (10mm) Diameter, For 790 series locks	12/Pkg
Actuators & Actuator Parts		
Actuators		
APKG1188270	Actuator, For Nos. A1000, A3100, A3200, A3500, A5000, A7200 & A7260 series locks	6/Pkg
APKG1188280	Actuator, For No. A3600 & A3700 series locks	6/Pkg
APKG1188290	Actuator, For No. A3800 series locks	6/Pkg
APKG1188010	Actuator, For No. AH10 series locks	6/Pkg
APKG1188030	Actuator, For No. AL50 series locks	6/Pkg
APKG2029010	Actuator, For No. A700 series locks	6/Pkg
APKG2084100	Actuator, For No. A7300 series locks	6/Pkg
APKG2083070	Actuator, Deadlock, For No. AL50 series locks	6/Pkg
APKG2081160	Actuator, Deadlock, For No. A1405 series locks	6/Pkg
APKGP32950	Actuator, For A3650 Series locks	12/Pkg
A36DLRET	Actuator, Deadlock, For Nos. A3600, A3700 & A3900 series locks	6/Pkg
A38DLRET	Actuator, Deadlock, For No. A3800 series locks	6/Pkg
APKG2084090	Actuator, Deadlock, For No. A700 series locks	6/Pkg
APKG2081250	Actuator, For Nos. A2000, A2001 & A2010 locks	6/Pkg
APKG2083060	Actuator, Deadlock For No. AH10 series locks	6/Pkg
Actuators for Edge® Key Control Cylinders		
APKG0001669	Actuator, For Nos. A1000, A5000 & A6000 series locks with Edge® key control cylinders	6/Pkg
APKG0001670	Actuator, Deadlocking, For Nos. A1000, A5000 & A6000 series locks with Edge® key control cylinders	6/Pkg
APKG0001666	Actuator, For No. A700 series locks with Edge® key control cylinders	6/Pkg
Actuator Parts		
APKG2205010	Washer, Retainer, For A700 series locks	10/Pkg
APKG2280010	Washer, Retainer, For AH10 series locks	10/Pkg
APKG2036010	Collar Only, For A3600, A3700 & A3800 series locks	10/Pkg
APKGP32947	Key-Retaining Converter, For A3650 Series locks	24/Pkg
APKGP32949	Actuator Coil Spring, For A3650 Series locks	24/Pkg
APKGP32946	Actuator Stop Plate, For A3650 Series locks	24/Pkg
Cover Plates		
APKG4680200	Cover Plate, For No. A700 series with standard, 748, R1 & R2 keyways	10/Pkg
APKG4680230	Cover Plate, Special, For No. A700 series with 1K, R7, R8 & Edge® keyways	10/Pkg
APKG4680210	Cover Plate, For Nos. A1000, A5000 & A6000 series with standard, R1 & R2 keyways	10/Pkg
APKG4680220	Cover Plate, Special, For A1000, A5000 & A6000 series with R7, R8 & Edge® keyways	10/Pkg
APKG0110026	Cover Plate, Stainless Steel, For A1000, A5000 & A6000 series with standard, R1 & R2 keyways	10/Pkg
APKG0P10774	Cover Plate, Stainless Steel, For A1000, A5000, & A6000 series with R7, R8 & Edge keyways	10/Pkg

KEY BLANKS: See pages 43-44 for respective key blanks or cut key information.
★★ Unless otherwise specified, Shelf Pack = 6, Master Carton = 24 ★★

Rekeying Parts *(continued)*

Product Number	Description	Units/Package
Screws and Nuts		
APKG4762010	Screw, Cylinder Adapter Housing, For A3600 & A3700 series locks	10/Pkg
APKG4764010	Screw, Cylinder Adapter Housing, For A3800 series locks	10/Pkg
APKG4752010	Screw Retainer, For AH10 series locks	25/Pkg
APKG4765010	Screw, Shackle Retention, For A700, A748, A780 & A790 series locks	10/Pkg
APKG0000220	Screw, Cylinder Retention, For New Style A2000 & A2010 series locks	10/Pkg
APKG4746010	Nut, Security	25/Pkg
APKG4761010	Screw, Security	25/Pkg
APKG0110027	Nut, Stainless Steel, Security	25/Pkg
APKG0110028	Nut, Stainless Steel, Screw	25/Pkg
APKGP32935	Screw, Cylinder Housing, For A3650 Series locks	24/Pkg

Shackles, Retention Pins & Shackle Springs

Product Number	Description	Units/Package
Shackles		
1/4in (6mm) Diameter		
APKG1582980	Boron, Chrome Plated, 1/4in (6mm) Diameter, 1in (25mm) vertical clearance	6/Pkg
APKG1583180	Boron, Chrome Plated, 1/4in (6mm) Diameter, 1-1/2in (38mm) vertical clearance	6/Pkg
APKG1583210	Boron, Chrome Plated, 1/4in (6mm) Diameter, 3in (75mm) vertical clearance	6/Pkg
5/16in (8mm) Diameter		
APKG1582240	Boron, Chrome Plated, 5/16in (8mm) Diameter, 1-1/8in (28mm) vertical clearance	6/Pkg
APKG1582290	Boron, Chrome Plated, 5/16in (8mm) Diameter, 2in (51mm) vertical clearance	6/Pkg
APKG1582310	Boron, Chrome Plated, 5/16in (8mm) Diameter, 3in (75mm) vertical clearance	6/Pkg
APKGP32859	Boron, Chrome Plated, 5/16in (8mm) Diameter, 1-1/8in (28mm) vertical clearance, For A3650 Series	6/Pkg
APKGP32913	Boron, Chrome Plated, 5/16in (8mm) Diameter, 2in (51mm) vertical clearance, For A3650 Series	6/Pkg
APKGP32914	Boron, Chrome Plated, 5/16in (8mm) Diameter, 3in (75mm) vertical clearance, For A3650 Series	6/Pkg
APKGP32917	Boron, Chrome Plated, 5/16in (8mm) Diameter, 5in (127mm) vertical clearance, For A3650 Series	6/Pkg
For 3/8in (10mm) Diameter		
APKG1581550	Boron, Chrome Plated, 3/8in (10mm) Diameter, 1-1/8in (28mm) vertical clearance	6/Pkg
APKG1581570	Boron, Chrome Plated, 3/8in (10mm) Diameter, 2in (51mm) vertical clearance	6/Pkg
APKG1581590	Boron, Chrome Plated, 3/8in (10mm) Diameter, 3in (75mm) vertical clearance	6/Pkg
7/16in (11mm) Diameter for No. A700 Series		
APKG1582940	Boron, Chrome Plated, 7/16in (11mm) Diameter, For No. A700 locks, 1-1/16in (27mm) vertical clearance	3/Pkg
APKG1582960	Boron, Chrome Plated, 7/16in (11mm) Diameter, For No. A701 locks, 2in (51mm) vertical clearance	3/Pkg
Shackle Springs		
APKG1601010	Spring, Shackle, 7/16in (11mm) Diameter, For AH10	25/Pkg
APKG1606010	Spring, Shackle, 5/16in (8mm) Diameter, For A1205, A1405, A3200, A3560, A3600, A3650, A5200, A5300, A5560, A7200 & AL50 series locks	25/Pkg
APKG1611010	Spring, Shackle, 3/8in (10mm) Diameter, For A1305, A3260, A3700, A3900, A5260, A5570, & A7260 series locks	25/Pkg
APKG1612010	Spring, Shackle, 7/16in (11mm) Diameter, For A700, A748, A3800 & A7300 series locks	25/Pkg
APKG1613010	Spring, Shackle, 1/4in (6mm) Diameter, For A1105, A3105, A5100 & A5530 series locks	25/Pkg
APKG1601010	Spring, Shackle, 7/16in (11mm) Diameter, For AH10, A3650 Series locks	25/Pkg

Tubular Padlock, Cam & Cylinder Lock Parts

Product Number	Description	Units/Package
Tubular Bottom Pins For Nos. A7000 & A8000 Series Tubular Cylinders		
APKG3666010	Tubular Pin, Bottom #1	100/Pkg
APKG3666020	Tubular Pin, Bottom #2	100/Pkg
APKG3666030	Tubular Pin, Bottom #3	100/Pkg
APKG3666040	Tubular Pin, Bottom #4	100/Pkg
APKG3666050	Tubular Pin, Bottom #5	100/Pkg
Tubular Top Pins For Nos. A7000 & A8000 Series Tubular Cylinders		
APKG3667010	Tubular Pin, Top #1	100/Pkg
APKG3667020	Tubular Pin, Top #2	100/Pkg
APKG3667030	Tubular Pin, Top #3	100/Pkg
APKG3667040	Tubular Pin, Top #4	100/Pkg
APKG3667050	Tubular Pin, Top #5	100/Pkg
APKG3667060	Tubular Pin, Top #6	100/Pkg
APKG3667070	Tubular Pin, Top #7	100/Pkg
Spindle Assembly		
APKG1256210	Assembly, Spindle, Cylinder, For Nos. A7200, A7260 & A7300 series locks	3/Pkg
APKG1288330	Assembly, Spindle, For No. A8068 series cams	10/Pkg
APKG1288340	Assembly, Spindle, For No. A8078 series cams	10/Pkg
APKG1288190	Assembly, Spindle, For No. A8118 series cams	10/Pkg
APKG1288350	Assembly, Spindle, For No. A8148 series cams	10/Pkg
APKG1256200	Assembly, Spindle, For No. A8300 series cams	10/Pkg
Retention Pin		
APKG1256170	Pin, Retention, For No. A8300 series cams	100/Pkg
APKG3082200	Pin, Retention, For No. A7000 series tubular cylinders	100/Pkg
APKG1255010	Pin, Retention, For No. A8000 series cams	100/Pkg
APKG1288180	Pin, Retention, For No. A8000 series cams	100/Pkg
APKG3680140	Pin, Retention, For No. A8000 series cams	100/Pkg
Cylinder Shell		
APKG1288160	Cylinder Shell, For No. A8078 series cams	10/Pkg
APKG1288130	Cylinder Shell, For No. A8118 series cams	10/Pkg
APKG1288150	Cylinder Shell, For No. A8148 series cams	10/Pkg
APKG1256110	Cylinder Shell, For No. A8300 series cams	10/Pkg
Stop Spacer		
APKG1227010	Spacer, Stop, For No. A8300 series cams	25/Pkg
APKG1249010	Spacer, Stop, For No. A8068 series cams	25/Pkg
APKG1250010	Spacer, Stop, For No. A8078 series cams	25/Pkg
APKG1229010	Spacer, Stop, For No. A8118 series cams	25/Pkg
APKG1231010	Spacer, Stop, For No. A8148 series cams	25/Pkg
APKG1228010	Spacer, Stop, For No. A7000 series locks	25/Pkg
APKG1229010	Spacer, Stop, For No. A8100 series locks	25/Pkg
Washers For A800 Series Cams		
APKG1288080	Washer, Filler	25/Pkg
APKG1288070	Washer, Spacer	25/Pkg
APKG1288090	Washer, Spur	25/Pkg
APKG1232010	Lock Washer	25/Pkg
Miscellaneous Parts		
APKGPC1	Cover, Cam Lock, For No. A8000 series cams	10/Pkg
APKG1223010	Cam, Tubular Cylinder, For A7200, A7260 & A7300 series	3/Pkg
APKG1256010	Spring, Cylinder, For No. A7000 & A8000 series locks	100/Pkg
APKG1288110	Stop Plate, 180 Deg., For No. A8000 series cylinders	100/Pkg
APKG1288120	Stop Plate, 90 Deg., For No. A8000 series cylinders	100/Pkg
APKG1233010	Nut, Hex. 3/4-24, For No. A8000 series cylinders	100/Pkg
APKG1234010	Nut, Hex. 9/32-28, For No. A8000 series cylinders	100/Pkg
APKG4949200	Driver, For Nos. A7200 & A7300 tubular locks	6/Pkg
APKG4949100	Driver, For No. A8300 series cams	50/Pkg
APKG4949160	Locking Bolt, For No. A8300 series cams	50/Pkg

KEY BLANKS: See pages 43-44 for respective key blanks or cut key information.

★★ Unless otherwise specified, Shelf Pack = 6, Master Carton = 24 ★★

Door Key Compatible Parts

Product Number	Description	Units/Package
Key-In-Knob Drivers		
ADRLOR39	Driver, Lori® 1539 Required to accept Lori® 1539 cylinders in American Lock® door key compatible padlocks	6/Pkg
ADRMED6	Driver, Medeco® Required to accept original Medeco® cylinders in American Lock® door key compatible padlocks	6/Pkg
ADRSCH6	Driver, Schlage® Required to accept original Schlage® cylinders in American Lock® door key compatible padlocks	6/Pkg
APKGP32941	Schlage® / Lori® 1599 KIK Cylinder Driver for A3650 series	6/Pkg
APKGP32940	Lori® 1539 KIK Cylinder Driver for A3650 series	6/Pkg
APKGP32945	Medeco® KIK Cylinder Driver for A3650 series	3/Pkg
APKGP56576	A3650WO hardware pack, (1) Key-Retaining Converter, (1) Schlage® / Lori® 1599 KIK Driver, (1) KIK Cylinder Housing, (1) Cylinder Housing Screw	4/Pkg
Padlock Drivers		
APKGP32938	Driver, Abus® 83 Series 2 padlock cylinder, For A3650 Series	3/Pkg
APKGP32939	Driver, American Lock APTC12/14 padlock cylinder, For A3650 Series	3/Pkg
APKGP32942	Driver, Master Lock 294 4-pin padlock cylinder, For A3650 Series	3/Pkg
APKGP32943	Driver, Master Lock 295 5-pin padlock cylinder, For A3650 Series	3/Pkg
APKGP32944	Driver, Master Lock 296 6-pin padlock cylinder, For A3650 Series	3/Pkg
Multi-Cylinders		
APKG0885000	Cylinder, Pin Tumbler, 0-Bit Schlage® Multi-Cylinder	6/Pkg
APKG0885010	Cylinder, Pin Tumbler, 0-Bit Yale® Multi-Cylinder	6/Pkg
APKG0885020	Cylinder, Pin Tumbler, 0-Bit Arrow® Multi-Cylinder	6/Pkg
APKG0885030	Cylinder, Pin Tumbler, 0-Bit Kwikset® Multi-Cylinder	6/Pkg
Small Format Interchangeable Core Components		
APKG0000048	Driver For Nos. SFIC A3100, A3200 & A3500 series locks	6/Pkg

Padlock Chains & Identification Tags

Product Number	Description	Units/Package
Padlock Chains & Identification Tags		
APKGZPC9	#40 Sash Chain, 9in (23cm) Long, Zinc Plated Chain with Mounting Plate	10/Pkg
APKGIDB	Identification Tags	10/Pkg
Clevis and Rivets		
APKG4881010	Clevis and Rivet, Zinc Plated, Fits 1/4in (6mm) diameter shackles and smaller	10/Pkg
APKG4881050	Clevis and Rivet, Zinc Plated, Fits 5/16in (8mm) diameter shackles and smaller	10/Pkg

Combination Tags

Product Number	Description	Units/Package
A7717000	Combination Lock Tags, Blank tags for A400 & A400K locks	10/Pkg

All marks are registered trademarks of their respective owners.

KEY BLANKS: See pages 43-44 for respective key blanks or cut key information.
 ★★ Unless otherwise specified, Shelf Pack = 6, Master Carton = 24 ★★

Services Kits and Tools

Product Number	Description	Units/Package
Service Kits		
AALSK18	Disc Tumbler Service Kit. Includes: (25) AL50 cylinder retaining pins, (25) AH10 cylinder retaining pins, (25) cylinder retaining screws, (10) AL50 shackle springs, (10) AH10 shackle springs, (100) brass disc tumblers, (10) tumbler v-springs, (10) AL50 small size ball bearings, (10) AH10 large size ball bearings, (10) AH10 knurled shackle pins, (10) AH10 retaining shackle pins, (3) cylinder assemblies with 2 keys per cylinder, (3) AH10 actuators & (3) AL50 actuators	1/Pkg
APK1	Pin Tumbler Service Kit, Includes: 100 ea. Bottom pins 1-8, 100 top pins, (10) driver springs, (5) security screws & (5) security nuts	1/Pkg
ASK8	Pin Tumbler Pinning Kit. Includes: 100 ea. Bottom pins 1-8, 100 ea. master pins 2-7, (100) top pins, (100) driver springs, (12) small A5000 series ball bearings, (12) large A700 series ball bearings, (25) security screws, (25) security nuts, (2) A700 series trap doors, (4) A5000 series trap doors, (1) American Lock 6-pin, APTC14 cylinder, (2) A700 series actuators, (4) A5000 series actuators, (1) American Lock 5-pin, APTC12 cylinder, (10) snap rings & (1) follower tool	1/Pkg
AMCPSK1	A3650 Padlock Service Kit. Includes: (12) Actuator, (12) Coil Spring, (12) Stop Plate, (12) Ball Bearing, (12) Shackle Spring, (12) Cylinder Housing Screw, (2) 2in Boron Shackle, (2) 3in Boron Shackle, (2) 5in Boron Shackle, (6) Schlage® / Lori® 1599 KIK Driver, (3) Lori® 1539 KIK Driver, (3) Medeco® KIK Driver, (6) Abus® 83 Driver, (3) American APTC12/14 Driver, (3) Master 296 Driver, (3) Master 295 Driver, (3) Master 294 Driver, (3) Padlock Cylinder Housing, (6) KIK Cylinder Housing, (2) Shackle Pin Change Tool, (2) Actuator Position Plug Tool, (12) Key-Retaining Converter	1/Pkg
ATCR3	Tubular Keying Service Kit, Includes: (100) key pins, (100) driver pins, (10) 180 degree stop plates, (10) 90 degree stop plates, (1) shell, (1) ATRT1 rekeying tool & (1) depth key	1/Pkg
Service Tools		
AFT	American Lock Padlock Cylinder Plug Follower	1/Pkg
APKGP33498	Shackle Pin Change Tool, For A3650 Series locks	3/Pkg
APKGP33174	Actuator Positioning Plug Tool, For A3650 Series locks	3/Pkg



ONE LOCK THAT DOES MORE

Make the A3650 Series Multi-Cylinder Padlock your go-to choice for more flexibility, convenience and inventory savings for you—and customization options and simplicity for your customers.

BROAD USES + MORE CYLINDERS

9 CYLINDER TYPES

Schlage® KIK
 Medeco® 20 Series
 ASSA® 65611
 Ilco®/Lori® 1539 & 1599
 Master Lock® 4-, 5- and 6-pin
 American Lock®
 Abus® 83 Series 2

2 NEW FEATURES

Quick-change shackle
 Key-retaining converter



How Edge Works

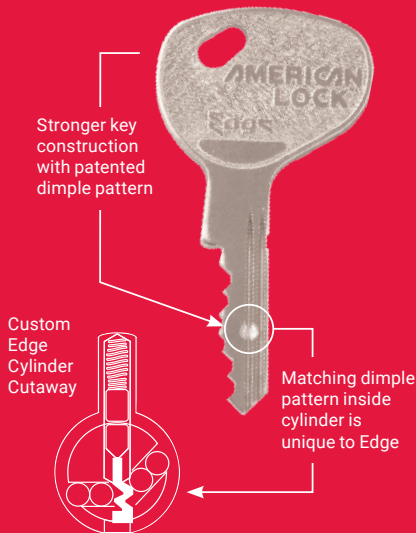

Control and Eliminate Unauthorized Key Duplication

Padlocks are an important, effective and often overlooked cornerstone of security. Edge® Key Control gives you confidence and control over the integrity of your security network.

- Control and eliminate unauthorized key duplication
- Keys available only from Master Lock Company and authorized Edge® partners – copies cannot be made at stores
- Implement a single keying system across all padlock security applications





Commercial Carded List Prices

Effective November 15, 2019



A800LHCD

- Great physical security – defy bolt cutters and prying
- Rekeyable – replaceable cylinder and shackle
- 6-pin tumbler cylinders provide superior pick resistance with tens of thousands of key changes

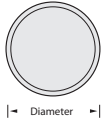

American Lock® Hidden Shackle Padlocks

Carded Model Number	Description	Case Pack Unit	Shackle Dimensions			Shackle Dimensions Metric			Package Size "W" and "H"
			A	B	C	A	B	C	
2-7/8in (72mm) diameter, 1-1/2in (38mm) thick, 6-pin – Unique hidden shackle padlock. Solid one-piece, chrome plated body with shrouded steel hasp. Rekeyable.									
A800LHCD	Solid Steel Padlock, Steel Hasp	4	3/8in	1-9/32in	1-23/32in	10mm	15mm	43mm	11in x 7in



A700D



A5300D



A5260D

- Heavy duty steel bodies
- Hardened boron alloy shackles for superior cut resistance
- Cylinders are pick-resistant

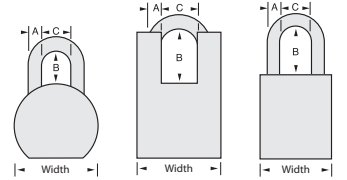

American Lock® Solid Steel Padlocks

Carded Model Number	Description	Case Pack Unit	Shackle Dimensions			Shackle Dimensions Metric			Package Size "W" and "H"
			A	B	C	A	B	C	
2-1/2in (64mm) wide, 1-1/8in (28mm) thick, 5-pin – Case hardened, chrome plated, solid steel body; case hardened, chrome plated, boron alloy steel shackle. Rekeyable.									
A700D	1-1/16in (27mm) Shackle	6	7/16in	1-1/16in	15/16in	11mm	27mm	29mm	4in x 7in
A701D	2in (50mm) Shackle	6	7/16in	2in	15/16in	11mm	50mm	29mm	4in x 7in
1-3/4in (44mm) wide, 3/4in (19mm) thick, 5-pin – Shrouded, case hardened, chrome plated, solid steel body; case hardened, chrome plated, boron alloy steel shackle. Rekeyable.									
A5300D	Shrouded Shackle	6	5/16in	1-1/8in	3/4in	8mm	29mm	19mm	4in x 7in
2in (50mm) wide, 3/4in (19mm) thick, 5-pin – Case hardened, chrome plated, solid steel body; case hardened, chrome plated, boron alloy steel shackle. Rekeyable.									
A5260D	1-1/8in (28mm) Shackle	6	3/8in	1-1/8in	3/4in	10mm	28mm	19mm	4in x 7in
1-3/4in (44mm) wide, 3/4in (19mm) thick, 5-pin – Case hardened, chrome plated, solid steel body; case hardened, chrome plated, boron alloy steel shackle. Rekeyable.									
A5200D	1-1/8in (28mm) Shackle	6	5/16in	1-1/8in	3/4in	8mm	28mm	19mm	4in x 7in
A5201D	2in (50mm) Shackle	6	5/16in	2in	3/4in	8mm	50mm	19mm	4in x 7in
1-1/2in (38mm) wide, 3/4in (19mm) thick, 5-pin – Case hardened, solid steel, chrome plated solid steel body; case hardened, chrome plated, boron alloy steel shackle. Rekeyable.									
A5100D	1in (25mm) Shackle	6	1/4in	1in	3/4in	6mm	25mm	19mm	4in x 7in
2in (50mm) wide, 7/8in (22mm) thick, 5-pin – Corrosion resistant, solid steel body; case hardened, corrosion resistant, boron alloy steel shackle. Non-Rekeyable.									
A50D	1-1/8in (28mm) Shackle	6	3/8in	1-1/8in	3/4in	10mm	28mm	19mm	4in x 7in



A20D

- Solid brass bodies resist corrosion - ideal for harsh environments
- Case hardened, boron alloy steel shackles for superior cut resistance
- Dual ball bearing locking mechanism resists pulling and prying

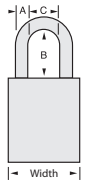

American Lock® Solid Brass Padlocks

Carded Model Number	Description	Case Pack Unit	Shackle Dimensions			Shackle Dimensions Metric			Package Size "W" and "H"
			A	B	C	A	B	C	
1-3/4in (44mm) wide, 3/4in (19mm) thick, 5-pin – Solid brass body; case hardened, chrome plated, boron alloy steel shackle. Non-rekeyable.									
A20D	1-1/8in (28mm) Shackle	6	5/16in	1-1/8in	3/4in	8mm	27mm	19mm	4in x 7in
A21D	2in (50mm) Shackle	6	5/16in	2in	3/4in	8mm	50mm	19mm	4in x 7in
1-1/2in (38mm) wide, 3/4in (19mm) thick, 5-pin – Solid brass body; case hardened, chrome plated, boron alloy steel shackle. Non-rekeyable.									
A40T	2-Pack, Keyed Alike	6	1/4in	1in	3/4in	6mm	25mm	19mm	4in x 7in



A30D

- Corrosion resistant solid aluminum – ideal for harsh environments
- Lightweight and spark resistant
- Hardened boron alloy steel shackles for superior cut resistance
- 5-pin cylinders for added pick resistance

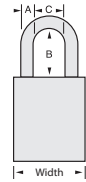

American Lock® Solid Aluminum Padlocks

Carded Model Number	Description	Case Pack Unit	Shackle Dimensions			Shackle Dimensions Metric			Package Size "W" and "H"
			A	B	C	A	B	C	
1-1/2in (38mm) wide, 3/4in (19mm) thick, 5-pin – Anodized solid aluminum body; case hardened, corrosion resistant, boron alloy steel shackle. Non-rekeyable.									
A30D	1in (25mm) Shackle	6	1/4in	1in	3/4in	6mm	25mm	19mm	4in x 7in



A535D

- Applications: trailers/van doors, garages, sheds/barns, storage buildings, vending machines, utility rooms and warehouse doors
- Zinc plated hardened steel for added strength and weatherability
- Hardened steel staple resists cutting, sawing and hammering



A825D



A850D



A875D



A885D

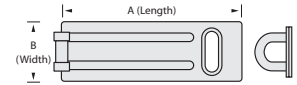

American Lock® Heavy Duty Hasps

Carded Model Number	Description	Shelf/Case Pack Unit	Hasp Dimensions		Hasp Dimensions Metric		Package Size "W" and "H"	
			A	B	A	B		
5in (127mm) centered hole, hardened steel hasp								
A535D	5in (127mm) Long	6/24	5in	2in	127mm	50mm	8in x 7in	
7-1/2in (184mm) straight bar, hardened steel hasp								
A825D	7-1/4in (184mm) Long	6/24	7-1/4in	1-5/8in	184mm	41mm	8in x 7in	
4-1/4in (108mm) 90 degree angle bar, hardened steel hasp								
A850D	4-1/4in (108mm) Long	6/24	4-1/4in	1-5/8in	108mm	41mm	8in x 7in	
6-1/4in (159mm) single hinge, hardened steel hasp								
A875D	6-1/4in (159mm) Long	6/24	6-1/4in	1-3/4in	159mm	44mm	8in x 7in	
7-3/4in (197mm) double hinge, hardened steel hasp								
A885D	7-3/4in (197mm) Long	6/24	7-3/4in	1-3/4in	197mm	44mm	8in x 7in	

INGENUITY • INDUSTRY • INTEGRITY



SECURITY PRODUCTS CATALOG



AMERICAN
LOCK



TABLE OF CONTENTS

The American Lock® Advantage

The Trusted Name in Security	3
BumpStop® Advanced Cylinder Technology	3
Edge® Key Control System	3
Weatherbuilt™ Padlock Protection	3

Custom Ordering and More

Make-to-order Capability	4
Keying Options	4
Shackle Options	4
Custom Marking	4
Key Charting	4
Lock Express	4

Solid and Stainless Steel Padlocks

Rekeyable Hidden Shackle Padlocks	6
Rekeyable Solid Steel Padlocks	7
Rekeyable Solid Stainless Steel Padlocks	9
Non-Rekeyable Solid Steel Padlocks	9
Blade Cylinder Solid Steel Padlocks	10
Tubular Cylinder Solid Steel Padlocks	10

Solid Brass Padlocks

Rekeyable Solid Brass Padlocks	12
Non-Rekeyable Solid Brass Padlocks	13
Blade Cylinder Solid Brass Padlocks	13

Solid Aluminum Padlocks

Safety Lockout Padlocks, Identification and Hasps	15
Rekeyable Solid Aluminum Padlocks	16
Non-Rekeyable Solid Aluminum Padlocks	16

Government Padlocks	17
---------------------------	----

Door Key Compatible Cylinders and Padlocks

Door Key Compatible Padlocks	19
------------------------------------	----

Interchangeable Cores and Padlocks

Interchangeable Core Padlocks	20
Small Format Interchangeable Core Padlocks	20
Large Format Interchangeable Core Padlocks	21

Cam Locks

Universal Mailbox Lock	22
Tubular Cam Locks and Inner Cylinder Locks	22
Disc Cam Locks	22

Hasps and Locking Bolts

High Security Hasps for Hidden Shackle Padlocks	23
Heavy Duty Hasps	24
Heavy Duty Gate Hasp	24
Locking Bolt	24

Combination Locks	25
-------------------------	----

Dealer Resources and Service Kits	25
---	----

THE AMERICAN LOCK® ADVANTAGE

THE TRUSTED NAME IN SECURITY

Since 1912, American Lock® has been the brand of choice in security products. Here are the reasons why.

Ingenuity. With more than 100 years of precision machining and quality manufacturing, American Lock products are, quite simply, not only strong but smart. They exceed commercial industry standards and defeat attempts to breach security at any level. In anticipation of any new threats that develop, our lock technology evolves, offering cutting-edge innovations that best serve our customers' needs.

Industry. The toughest padlocks available, American Lock products serve industry, government and commercial users worldwide. Our locks not only stand up to attack, but can also withstand years of abuse from the harshest environments—ideal for industrial use. The strength and endurance of our premium, hard-working locks is what has earned them the distinction of "The Locksmith's Lock."

Integrity. American Lock is proud of our record of serving our customers with the greatest integrity and of earning their trust for nearly a century. Throughout the years, we've been entrusted with protecting the most valuable assets of businesses, utilities and municipalities with our high security products. That speaks volumes about the confidence our customers place in us. As our locks endure, so does our customers' trust in American Lock.

The American Lock advantage doesn't stop at just building the toughest and most durable locks in the marketplace. We take security to a new level with the following innovations and services.

BUMPSTOP® ADVANCED CYLINDER TECHNOLOGY

Counter the ever-growing security threat of lock "bumping" with this patented technology. The BumpStop® feature prevents the transfer of force from the bump key to the pins and blocks rotation of the cylinder so that the lock remains locked. A reverse rake tapered driver pin, high performance spring and precision tolerance chamber make these locks four times more resistant to bumping than the toughest proposed anti-bump industry standard.



EDGE® KEY CONTROL SYSTEM

Prevent unauthorized key duplication with this cost effective, patented system. An innovative cylinder design with an additional locking mechanism creates numerous one-of-a-kind "virtual keyways." This means that all operating keys are unique to a facility and new key blanks are only available at authorized dealers. Edge® 1539 cylinders are available for most American Lock padlocks.



WEATHERBUILT™ PADLOCK PROTECTION

Experience the ultimate in padlock protection. Our Weatherbuilt™ locks are built to endure the harshest environments, with enhanced weather, debris, temperature and chemical resistance—as well as convenient keyway covers and corrosion resistant shackle options.

WEATHERBUILT™



**AMERICAN
LOCK**
100TH ANNIVERSARY
1912-2012



CUSTOM ORDERING AND MORE

The American Lock advantage goes beyond product. Our custom order capabilities, keying and shackle options, custom marking, key charting and Lock Express® service allow us to create tailored security solutions to meet each customer's specific needs.

MAKE-TO-ORDER CAPABILITY

We custom build American Lock security products to our customers' specific requirements. Choices include the following.

KEYING OPTIONS

American Lock® offers full keying flexibility. Over 60 padlock, door hardware or small format interchangeable core keyways are available. Choose from:

Keyed Different (KD)—Each padlock has its own key. This is the standard for all products unless requested otherwise.

Keyed Alike (KA)—Padlocks can be opened with the same key, offering convenience and eliminating multiple keys for those who use numerous padlocks.

Master Keyed (MK)—In this system, one key can access one or more separate groups of padlocks or cylinders that are each operated by their own change keys. This is ideal for supervisor access.



Plus, American Lock offers key retaining or deadlocking options, which prevent the padlock from being left unlocked, as the keys cannot be removed while the padlock is open. And we also offer restricted keyways—restricted key systems with factory controlled keys that aren't available at a locksmith, so there is less chance of unauthorized key duplication.

SHACKLE OPTIONS

American Lock offers a wide range of shackle options, including shackles in extra lengths, chain attachments and various materials, including hardened boron alloy, brass and stainless steel.



CUSTOM MARKING

These options include laser engraving or hard stamping of company logos or any alphanumeric characters for safety lockout purposes, employee locker identification or company or institutional/school branding.



KEY CHARTING

This service maintains the series of key numbers for five- or six-pin padlocks. The keys are blind coded and the key numbers are maintained in a chart. Using one of these systems, a user can simply call to order the next key number in the sequence or a replacement key.

The charting system is perfect for those who have a safety lockout application at a medium or large facility, as we can offer 80,000 unique key cuts per plant location—eliminating the chance of duplication, helping to prevent lockout related accidents, and making it easier to maintain OSHA requirements. For more information on key charting, please see the American Lock price book.

LOCK EXPRESS PROGRAM

For those who need their orders quickly, we're ready to deliver the best padlocks in the industry faster than ever before—available to ship in 24 hours. Customers can choose one-day, two-day or ground delivery, and be assured that the order will arrive keyed exactly as specified, in the style and color needed.



All these options are just another part of the American Lock advantage. Whatever level of security you need, you can count on American Lock to be your total security solutions provider. It's a name that's delivered for years: American Lock.



SOLID STEEL PADLOCKS

MAXIMUM SECURITY

American Lock® solid steel padlocks offer the highest protection of hardened steel. Our padlocks come in a wide range of widths, with shackle lengths and diameters to fit any application—great for outdoor protection of commercial buildings, industrial plants and perimeters, remote or unattended properties and high risk areas.

- The strongest padlock available—hardened, triple plated steel bodies resist break-in attempts, corrosion, rust and debris while the stainless steel double ball locking mechanism further assures the lock's strength and performance
- Hardened boron alloy shackles offer superior protection against cutting, while serrated cylinder pins resist picking
- Rekeyable five- or six-pin cylinders can be keyed differently, alike, master keyed or grand master keyed, with a variety of keyways



SOLID STAINLESS STEEL PADLOCKS

HIGHEST CORROSION RESISTANCE

American Lock stainless steel rectangular padlocks offer strong security with the highest resistance to harsh weather and extreme conditions. They are ideal for securing equipment and buildings in outdoor or corrosive environments, such as heavy-duty industrial or marine equipment and factories, and outdoor structures such as sheds, gates or other buildings. See page 9.

- Stainless steel bodies resist cutting, sawing and corrosion, and their stainless steel shackles provide superior weather and cut resistance
- Exceeds ASTM Grade 6 requirements for padlock corrosion resistance
- Five- and six-pin brass cylinders and serrated pins are pick resistant with tens of thousands of key changes



REKEYABLE HIDDEN SHACKLE PADLOCKS

American Lock's round, heavy-duty, hidden shackle padlocks are the toughest padlocks of their type ever offered to security professionals. Our industrial-strength padlocks are rekeyable and have a replaceable cylinder and shackle.

- Padlocks offer maximum protection against drilling, sawing, prying, crowbars, dent pullers and hammers
- Six-pin tumbler cylinders provide superior pick resistance, with tens of thousands of key changes
- Ideal for high security areas and are adaptable for applications on garages, storage buildings, vehicles, commercial buildings, industrial plants and vending machines
- The three flat back locks, models A2500, A2010 and A2001, are tapped and threaded to attach to either high security hasp A801 or A802, featured on page 23. When affixed, for swing door applications, the combination provides both maximum security by making it virtually impossible to pry the lock away from the hasp and greater convenience, as the lock remains attached to the hasp when unlocked
- Choose bundle packs that combine the lock with patent-pending high security hasps for greater convenience and physical security – defying bolt cutters and prying

A2500

This rekeyable, flat back hidden shackle padlock offers a hardened steel body and a convenient front access keyway, anti-drill cylinder cover plate and easy-to-use spring loaded shackle. Precision machined from high quality solid steel bar and triple plated for superior rust resistance, it exceeds the highest performing grade level (Grade 6) within the American Society for Testing Materials (ASTM) Padlock Standard (F883).



A2500



A2500LHC1



A2000



A800LHC

A2500LHC1

This bundle pack combines our toughest lock, the solid steel A2500, attached to high security hasp A801. This combination offers maximum security for swing door applications.

A2000

This hidden shackle, stepped back padlock has a die cast body. It will lock any of the high security hasps shown on page 23.

A800LHC

This model combines the A2000 stepped back die cast lock with the A800 cast steel hasp.

A2010

This lock is precision machined from high quality solid steel bar and triple plated for superior rust resistance. For maximum security, this lock features a flat back design so it can be fastened to the high security hasps, A801 and A802, featured on page 23.



A2010

A2001

This hidden shackle padlock has a die cast, flat back body. It can be attached to high security hasps A801 and A802 featured on page 23.



A2001

A801LHC

In this bundle pack, the die cast A2001 padlock is pre-attached to the A801 truck hasp, offering greater security in swing door applications.



A801LHC

A802LHC

This lock and hasp combination attaches the strong die cast A2001 padlock to the A802 trailer hasp, ideal for securing overlapping doors with a raised lip or seal.



A802LHC

Specifications	Models				
Padlocks	A2500	A2010	A2001		A2000
Bundle Packs	A2500LHC1		A801LHC	A802LHC	A800LHC
Cylinder	6-pin / APTC14		6-pin / APTC2001		
Lock Material	Solid Steel		Die Cast		
Lock Style	Flat Back				Stepped Back
Hasp Dimensions	8-3/4" x 4-1/2" (222mm x 114mm)		8-3/4" x 4-1/2" (222mm x 114mm)	11-7/16" x 4-1/2" (291mm x 114mm)	9-1/16" x 4-1/2" (230mm x 114mm)

Keying Options – Keyed Alike (KA), Keyed Different (KD), Master Keyed (MK), BumpStop®, Edge®

REKEYABLE SOLID STEEL PADLOCKS

These padlocks offer the greatest security and fit for real world applications. They're virtually indestructible with hardened, chrome plated solid steel bodies that resist cutting, sawing and corrosion and hardened boron alloy steel shackles that offer superior cut resistance.

- Hardened stainless steel serrated pins (A790, A780 & A748 only) in five- and six-pin brass cylinders and dual ball bearing locking mechanisms resist picking, pulling and prying
- Rekeyable, with replaceable cylinder and shackle, making them easy to service
- Great for security gates, sheds, truck and van doors, industrial machinery and construction equipment



Maximum Security Padlocks

Solid steel padlocks have the largest lock bodies and shackles to best withstand physical attack. Stainless steel cylinder pins provide increased drill resistance.

A790 Series

For all: body width = 3" (75mm), body thickness = 1" (25mm), shackle diameter = 1/2" (13mm), and horizontal clearance = 1-5/16" (33mm)

A780 and A784 Series

For all: body width = 2-1/2" (63mm), body thickness = 1" (25mm), shackle diameter = 7/16" (11mm), and horizontal clearance = 1-1/4" (32mm)

Specifications	Models	
6-pin / APTC14	A790	A780
Shackle Height	1-1/2" (38mm)	1-1/4" (32mm)



Keying Options – Keyed Alike (KA), Keyed Different (KD), Master Keyed (MK), BumpStop®

Round Body Padlocks

The American Lock original, the A700 series locks offer superior security.

For all: body width = 2-1/2" (63mm), body thickness = 1-1/8" (28mm), shackle diameter = 7/16" (11mm), and horizontal clearance = 15/16" (24mm)

Specifications	Chrome Plated Models		Zinc Plated Models	
5-pin / APTC12	A700	A701	A702	A703
6-pin / APTC14	A706	A707		
Shackle Height	1-1/16" (27mm)	2" (50mm)	1-1/16" (27mm)	2" (50mm)

Keying Options – Keyed Alike (KA), Keyed Different (KD), Master Keyed (MK), BumpStop®, Edge®



Shrouded Padlocks

Shackle shrouds offer the greatest protection against cutting and prying attacks.
Stainless steel shackles available (SS)

A748 Series

For all: body width=2-1/2" (63mm), body thickness=1" (25mm), shackle diameter=7/16" (11mm), and horizontal clearance=15/16" (24mm)

A5360 and A6360 Series

For all: body width=2" (50mm), body thickness=3/4" (19mm), shackle diameter=3/8" (10mm), and horizontal clearance=3/4" (19mm)

A5300 and A6300 Series

For all: body width=1-3/4" (44mm), body thickness=3/4" (19mm), shackle diameter=5/16" (8mm), and horizontal clearance=3/4" (19mm)

Specifications	Models		
6-pin / APTC748	A748		
5-pin / APTC12		A5360	A5300
6-pin / APTC14		A6360	A6300
Shackle Height	1" (25mm)	1-1/8" (28mm)	

Keying Options – Keyed Alike (KA), Keyed Different (KD), Master Keyed (MK), BumpStop®

2" (50mm) Rectangular Padlocks

Weatherbuilt™ Padlock Protection available.

Stainless steel shackles available (SS)

For all: body width=2" (50mm), body thickness=3/4" (19mm), shackle diameter=3/8" (10mm), and horizontal clearance=3/4" (19mm)

Specifications	Models		
5-pin / APTC12	A5260	A5261	A5262
6-pin / APTC14	A6260	A6261	A6262
Shackle Height	1-1/8" (28mm)	2" (50mm)	3" (75mm)

Keying Options – Keyed Alike (KA), Keyed Different (KD), Master Keyed (MK), BumpStop®, Edge®

1-3/4" (44mm) Rectangular Padlocks

Weatherbuilt™ Padlock Protection available.

Stainless steel shackles available (SS)

For all: body width=1-3/4" (44mm), body thickness=3/4" (19mm), shackle diameter=5/16" (10mm), and horizontal clearance=3/4" (19mm)

Specifications	Models			
5-pin / APTC12	A5200	A5201	A5202	A5205
6-pin / APTC14	A6200	A6201	A6202	A6205
Shackle Height	1-1/8" (28mm)	2" (50mm)	3" (75mm)	5" (127mm)

Keying Options – Keyed Alike (KA), Keyed Different (KD), Master Keyed (MK), BumpStop®, Edge®



1-1/2" (38mm) Rectangular Padlocks

For all: body width=1-1/2" (38mm), body thickness=3/4" (19mm), shackle diameter=1/4" (6mm), and horizontal clearance=3/4" (19mm)

Specifications	Models		
5-pin / APTC12	A5100	A5101	A5102
6-pin / APTC14	A6100	A6101	A6102
Shackle Height	1" (25mm)	1-1/2" (38mm)	3" (75mm)

Keying Options – Keyed Alike (KA), Keyed Different (KD), Master Keyed (MK), BumpStop®, Edge®

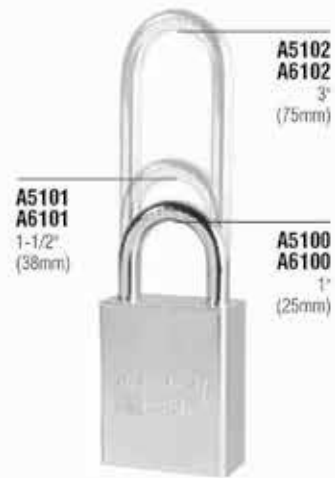

REKEYABLE SOLID STAINLESS STEEL PADLOCKS

Weatherbuilt™ Padlock Protection available.

A5400 and A6400

For all: body width=1-3/4" (44mm), body thickness=3/4" (19mm), shackle diameter = 5/16" (8mm) and horizontal clearance=3/4" (19mm)

A5460 and A6460

For all: body width=2" (50mm), body thickness=3/4" (19mm), shackle diameter = 3/8" (10mm) and horizontal clearance=3/4" (19mm)

Specifications	Models	
5-pin / APTC12	A5400	A5401
	A5460	A5461
6-pin / APTC14	A6400	A6401
	A6460	A6461
Shackle Height	1-1/8" (28mm)	2" (50mm)

Keying Options – Keyed Alike (KA), Keyed Different (KD), Master Keyed (MK), BumpStop®, Edge®



NON-REKEYABLE SOLID STEEL PADLOCKS

Designed to secure job boxes and other heavy duty applications. Non-serviceable five-pin APTC12 cylinder can be factory keyed to your requirements.

A50HS

Fits Knaack and Watchman IV job boxes and has stainless steel pins for additional drill resistance.

For all: body width=2" (50mm), body thickness=7/8" (22mm), shackle diameter=3/8" (10mm) and horizontal clearance=3/4" (19mm)

Specifications	Models		
5-pin / APTC12	A50 A50HS	A51	A52
Shackle Height	1-1/8" (28mm)	2" (50mm)	3" (75mm)

Keying Options – Keyed Alike (KA), Keyed Different (KD), Master Keyed (MK), BumpStop®, Edge®



BLADE CYLINDER SOLID STEEL PADLOCKS

Rekeyable, disc tumbler cylinders perform extremely well in external applications— dirt and debris more easily pass through the cylinder and wafers, so the lock does not clog and continues to operate well.

AH10, AH11

Chrome plated solid steel with nickel plated shackles

AH100PB, AH110PB

Orange powder coated body and orange rubber bumper

For all: body width=2" (50mm), shackle diameter=7/16" (11mm), and horizontal clearance=3/4" (19mm)

Specifications	Models	
ABTC1	AH10 AH100PB	AH11 AH110PB
Shackle Height	1-1/16" (27mm)	2" (50mm)

Keying Options – Keyed Alike (KA), Keyed Different (KD)

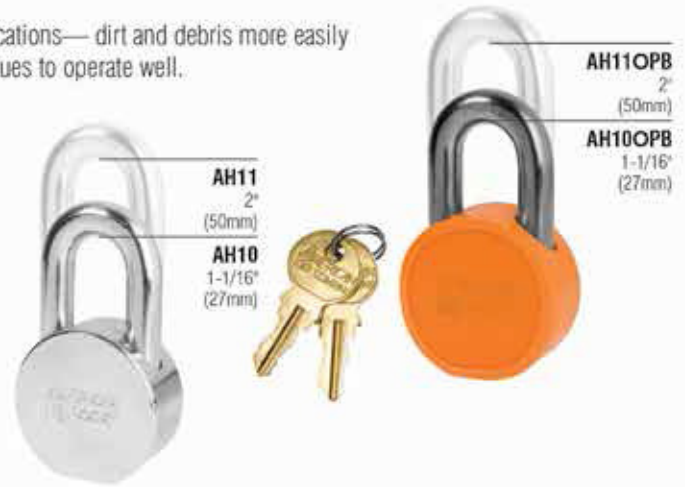

TUBULAR CYLINDER SOLID STEEL PADLOCKS

Pick resistant, rekeyable seven-pin tubular cylinders provide more than 50,000 key changes and meet National Automatic Merchandising Association (NAMA) requirements. **Stainless steel shackles available (SS)**

A7300 Series

For all: body width=2-1/4" (57mm), body thickness=7/8" (22mm), shackle diameter=7/16" (11mm), and horizontal clearance=15/16" (24mm)

A7260 Series

For all: body width=2" (50mm), body thickness=7/8" (22mm), shackle diameter=3/8" (10mm), and horizontal clearance=3/4" (19mm)

A7200 Series

For all: body width=1-3/4" (44mm), body thickness=7/8" (22mm), shackle diameter=5/16" (8mm), and horizontal clearance=3/4" (19mm)

Specifications	Models				
7-pin / AHTC2	A7300 A7260 A7200	A7301 A7261 A7201	A7262 A7202	A7205	
Shackle Height	1-1/8" (28mm)	2" (50mm)	3" (75mm)	5" (127mm)	

Keying Options – Keyed Alike (KA), Keyed Different (KD)





SOLID BRASS PADLOCKS

CORROSION-RESISTANT SECURITY

American Lock® solid brass padlocks resist salt water and other moisture, offering ideal protection to equipment and buildings in even the harshest outdoor environments and corrosive atmospheres. They're excellent for protecting marine equipment, industrial plants and perimeters, sheds, gates and outbuildings. As with all American Lock products, brass padlocks come in a full spectrum of widths, with shackle diameters and lengths to meet the needs of all users.

- Hardened boron alloy shackles offer superior cut resistance, while dual stainless steel ball bearing locking mechanism resists pulling and prying
- Shackles are chrome plated for corrosion resistance—rust-resistant brass shackles available for marine applications
- Five- and six-pin brass cylinders and serrated pins are pick resistant with tens of thousands of key changes
- Can meet all keying requirements—brass five- or six-pin cylinders can be keyed differently, alike, master keyed or grand master keyed, with a variety of keyways



REKEYABLE SOLID BRASS PADLOCKS

2" (50mm) Rectangular Padlocks

Weatherbuilt™ Padlock Protection available. **Brass shackles available (B)**
Stainless steel shackles available (SS)

For all: body width=2" (50mm), body thickness=3/4" (19mm),
 shackle diameter=3/8" (10mm), and horizontal clearance=3/4" (19mm)

Specifications	Models		
5-pin / APTC12	A5570	A5571	A5572
6-pin / APTC14	A6570	A6571	A6572
Shackle Height	1-1/8" (28mm)	2" (50mm)	3" (75mm)

Keying Options – Keyed Alike (KA), Keyed Different (KD), Master Keyed (MK),
 BumpStop®, Edge®



1-3/4" (44mm) Rectangular Padlocks

Weatherbuilt™ Padlock Protection available. **Brass shackles available (B)**
Stainless steel shackles available (SS)

For all: body width=1-3/4" (44mm), body thickness=3/4" (19mm),
 shackle diameter=5/16" (8mm), and horizontal clearance=3/4" (19mm)

Specifications	Models			
5-pin / APTC12	A5560	A5561	A5562	A5565
6-pin / APTC14	A6560	A6561	A6562	A6565
Shackle Height	1-1/8" (28mm)	2" (50mm)	3" (75mm)	5" (127mm)

Keying Options – Keyed Alike (KA), Keyed Different (KD), Master Keyed (MK),
 BumpStop®, Edge®



1-1/2" (38mm) Rectangular Padlocks

Brass shackles available (B)

For all: body width=1-1/2" (38mm), body thickness=3/4" (19mm),
 shackle diameter=1/4" (6mm), and horizontal clearance=3/4" (19mm)

Specifications	Models		
5-pin / APTC12	A5530	A5531	A5532
6-pin / APTC14	A6530	A6531	A6532
Shackle Height	1" (25mm)	1-1/2" (38mm)	3" (75mm)

Keying Options – Keyed Alike (KA), Keyed Different (KD), Master Keyed (MK),
 BumpStop®, Edge®



NON-REKEYABLE SOLID BRASS PADLOCKS

Non-serviceable five-pin APTC12 cylinder can be factory keyed to your requirements.
Brass shackles available (B)

A20 Series

Weatherbuilt™ Padlock Protection available.

Stainless steel shackles available (SS)

For all: body width=1-3/4" (44mm), body thickness=3/4" (19mm),
 shackle diameter=5/16" (8mm), and horizontal clearance=3/4" (19mm)

A40 Series

For all: body width=1-1/2" (38mm), body thickness=3/4" (19mm),
 shackle diameter=1/4" (6mm), and horizontal clearance=3/4" (19mm)



Specifications	Models				
5-pin / APTC12	A40	A20	A41	A21	A22 A42
Shackle Height	1" (25mm)	1-1/8" (28mm)	1-1/2" (38mm)	2" (50mm)	3" (75mm)

**Keying Options – Keyed Alike (KA),
 Keyed Different (KD), Master Keyed (MK),
 BumpStop®, Edge®**



BLADE CYLINDER SOLID BRASS PADLOCKS

Rekeyable, disc tumbler cylinders perform extremely well in external applications—
 dirt and debris more easily pass through the cylinder and wafers, so the lock does
 not clog and continues to operate well. **Brass shackles available (B)**
Stainless steel shackles available (SS)

1-3/4" (44mm) Rectangular Padlocks

For all: body width=1-3/4" (44mm), body thickness=3/4" (19mm),
 shackle diameter=5/16" (8mm), and horizontal clearance=3/4" (19mm)

Specifications	Models			
ABTC1	AL50	AL51	AL52	AL55
Shackle Height	1-1/8" (28mm)	2" (50mm)	3" (75mm)	5" (127mm)

Keying Options – Keyed Alike (KA), Keyed Different (KD)

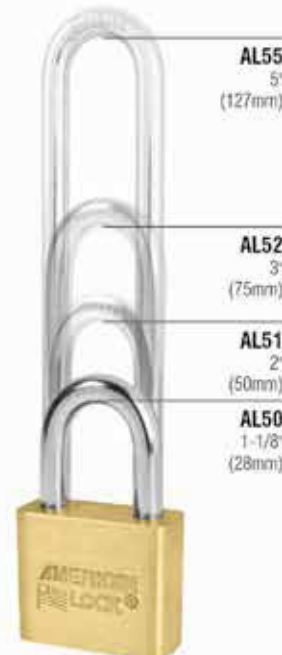



SOLID ALUMINUM PADLOCKS

SAFETY LOCKOUT AND DURABLE SECURITY

Our top-selling lightweight, solid aluminum padlocks were an industry breakthrough when introduced and continue to be a top seller. American Lock's aluminum line is offered in nine anodized finishes for easy identification as well as in a full range of widths, with many shackle diameters and lengths available. Our aluminum padlocks can stand up to caustic environments and are best for lockout/tagout uses, utility storage areas, sheds, gates and outbuildings.

- Made from an exclusive aluminum alloy, offering strong protection similar to brass in harsh and corrosive environments
- Lightweight, durable padlocks are ideal to carry from lockout job to lockout job
- All have a sturdy anodized finish, which is perfect for food processing applications
- Most come with hardened boron alloy steel shackles for superior cut resistance and chrome plated for extra corrosion resistance—brass shackle option is offered on some models
- Dual ball bearing locking mechanism resists pulling and prying
- Laser engraving option lets companies permanently add employee information on padlocks for lockout identification compliance



SAFETY LOCKOUT PADLOCKS, IDENTIFICATION AND HASPS

1-1/2" (38mm) Rekeyable Rectangular Padlocks

- Lightweight, durable padlocks are easy to carry from one lockout job to the next
- Choice of nine colors to organize by department: black (BLK), blue (BLU), brown (BRN), clear (CLR), green (GRN), orange (ORJ), purple (PRP), red (RED), yellow (YLW)
- Anodized, durable finish is fused to the lock surface and will not chip, making it ideal for food processing facilities; easily withstands washdown chemicals and caustic environments
- Brass shackle option enhances spark resistance
- Exclusive-to-safety W401 keyway (W417 for Master Keyed systems) with deeper pins and key cut depths minimizes inadvertent key interchange caused by years of hard use. More than 40,000 unique codes assure no duplication in a facility
- Laser engraving option lets companies permanently add employee information on padlocks for lockout identification compliance

For all: body width = 1-1/2" (38mm), body thickness = 3/4" (19mm), shackle diameter = 1/4" (6mm), and horizontal clearance = 3/4" (19mm)

Specifications	Models		
W401 Safety	S1105	S1106	S1107
W417 Safety*	S1105MK	S1106MK	S1107MK
5-pin / APTC12	A1105	A1106	A1107
6-pin / APTC14	A1165	A1166	A1167
Shackle Height	1" (25mm)	1-1/2" (38mm)	3" (75mm)

*W417 for MK and KAMK models only

Keying Options – Keyed Alike (KA), Keyed Different (KD), Master Keyed (MK), BumpStop®, Edge®

Padlock Identification Labels

Photo ID labels – Personalize the S1100/A1100 Series safety padlocks in your facility to make the user immediately recognizable.

Write-on Labels – Customize the S1100/A1100 Series safety lockout padlocks with worker name and department.

Safety Lockout Hasps

Steel lockout hasps in popular scissors style feature locking tabs for extra pry resistance. Red PVC-free coating on handle identifies safety application. Two sizes available to fit most applications.

Specifications	Models	
	AL080	AL0802
Jaw Diameter	1" (25mm)	1-1/2" (38mm)



REKEYABLE SOLID ALUMINUM PADLOCKS

Available in nine different colors: black (BLK), blue (BLU), brown (BRN), clear (CLR), green (GRN), orange (ORJ), purple (PRP), red (RED), yellow (YLW).

Weatherbuilt™ Padlock Protection available;

Brass shackles available (B)

Stainless steel shackles available (SS)

2" (50mm) Rectangular Padlocks

For all: body width=2" (50mm), body thickness=3/4" (19mm), shackle diameter=3/8" (10mm), and horizontal clearance=3/4" (19mm)

Specifications	Models		
5-pin / APTC12	A1305	A1306	A1307
6-pin / APTC14	A1365	A1366	A1367
Shackle Height	1-1/8" (28mm)	2" (50mm)	3" (75mm)

Keying Options – Keyed Alike (KA), Keyed Different (KD), Master Keyed (MK), BumpStop®, Edge®

1-3/4" (44mm) Rectangular Padlocks

For all: body width=1-3/4" (44mm), body thickness=3/4" (19mm), shackle diameter=5/16" (8mm), and horizontal clearance=3/4" (19mm)

Specifications	Models			
5-pin / APTC12	A1205	A1206	A1207	A1209
6-pin / APTC14	A1265	A1266	A1267	A1269
Shackle Height	1-1/8" (28mm)	2" (50mm)	3" (75mm)	5" (127mm)

Keying Options – Keyed Alike (KA), Keyed Different (KD), Master Keyed (MK), BumpStop®, Edge®

NON-REKEYABLE SOLID ALUMINUM PADLOCKS

Non-serviceable five-pin APTC12 cylinder can be factory keyed to your requirements. **Brass shackles available (B)**

1-3/4" (44mm) Rectangular Padlocks

Weatherbuilt™ Padlock Protection available;

Stainless steel shackles available (SS)

For A10 Series: body width=1-3/4" (44mm), body thickness=3/4" (19mm), shackle diameter=5/16" (8mm), and horizontal clearance=3/4" (19mm)

1-1/2" (38mm) Rectangular Padlocks

For A30 Series: body width=1-1/2" (38mm), body thickness=3/4" (19mm), shackle diameter=1/4" (6mm), and horizontal clearance=3/4" (19mm)

Specifications	Models				
5-pin / APTC12	A30	A10 A10SS	A31	A11 A11SS	A12 A32
Shackle Height	1" (25mm)	1-1/8" (28mm)	1-1/2" (38mm)	2" (50mm)	3" (75mm)

Keying Options – Keyed Alike (KA), Keyed Different (KD), Master Keyed (MK), BumpStop®, Edge®

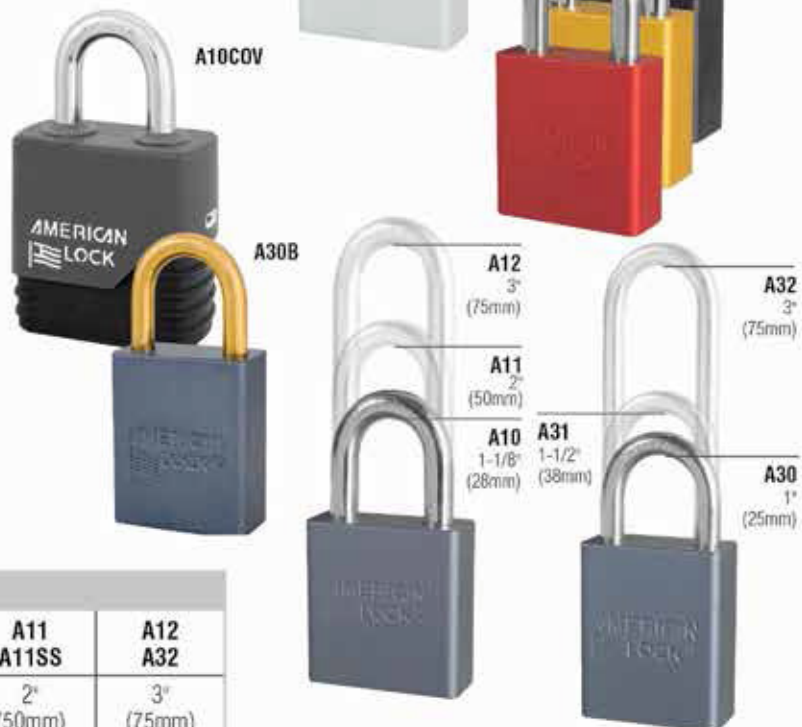



GOVERNMENT PADLOCKS

American Lock® padlocks offer unsurpassed quality and superior performance, exceeding commercial industry standards. These padlocks protect assets at facilities throughout the world, securing high-value property, withstanding extensive use and harsh environments, and defeating attempts to breach security. American Lock brings this pride and workmanship to our padlocks, made to exacting government standards.

For over 65 years, American Lock has provided security solutions to every segment of the U.S. government and military defense agencies. With our unmatched line of security products, American Lock has more than 60 National Stocking Numbers (NSNs) assigned to our product line to meet government requirements.

Our A5200GLN and ASL40N solid body government locks are designed to stringent government standards CID-A-A-59486 and CID-A-A-59487. They feature a five-pin tumbler cylinder for more than 10,000 key changes and a dual locking mechanism for superior pry resistance. For added security, all models have non-removable keys.

American Lock government padlocks can be ordered by NSN or by Commercial Part Number. Additional variations are available to be built to your specific requirements:

- Combine individual locks into custom sets consisting of any quantity or keying combination
- Padlocks can be keyed alike or master keyed
- Available with extra length shackles and laser engraved marking on ASL40N and A5560N Locks
- Chain attachments available to attach to shackle so lock cannot be removed
- Brass shackle options, available on brass padlocks, offer extra protection against the elements
- Government padlocks use an Advanced Cylinder Technology to resist bump attacks

Please visit our Government Padlock section of www.americanlock.com or see the Government price list for the full NSN listing.



Solid Steel Rectangular Padlocks

Solid steel locks have a zinc chromate finish. Available with chains (W) attached to the shackle. **Stainless steel shackles available (SS)**

Shrouded Padlocks

Shackle shrouds offer the greatest protection against cutting and prying attacks.

For A5200GLN Series: body width=1-3/4" (44mm), body thickness=3/4" (19mm), shackle diameter=5/16" (8mm), and horizontal clearance=3/4" (19mm)

Specifications	Models		
5-pin	A5200GLN A5200GLSHN A5200GLWN	A5201GLN A5201GLWN	A5202GLN A5202GLWN
Shackle Height	1-1/8" (28mm)	2" (50mm)	3" (75mm)

Keying Options – Keyed Alike (KA), Keyed Different (KD), Master Keyed (MK)

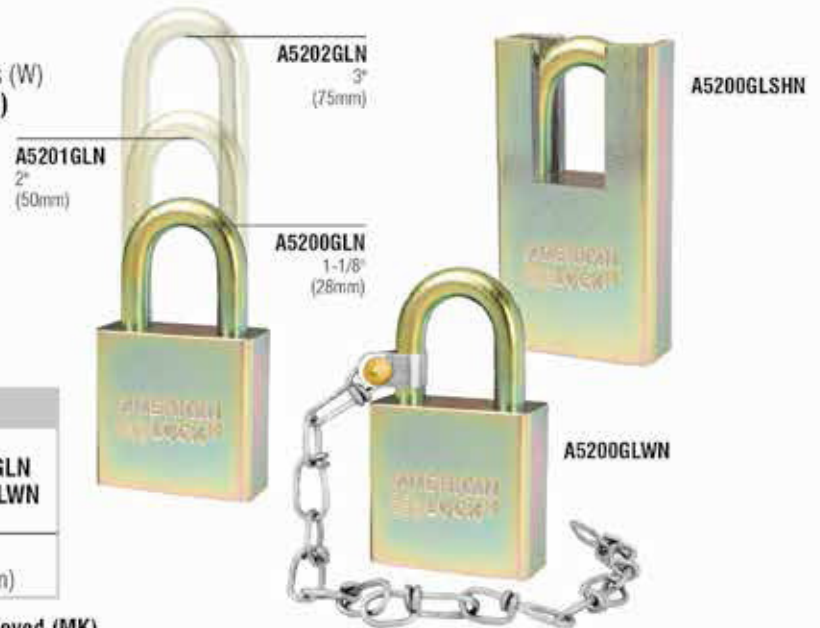

Solid Brass Rectangular Padlocks

Solid brass locks are available in two body widths with choice of hardened steel or brass shackle.

For A5560NB Series: body width=1-3/4" (44mm), body thickness=3/4" (19mm), shackle diameter=5/16" (8mm), and horizontal clearance=3/4" (19mm)

For ASL40N Series: body width=1-1/2" (38mm), body thickness=3/4" (19mm), shackle diameter=1/4" (6mm), and horizontal clearance=3/4" (19mm)

Specifications	Models		
5-pin	ASL40N		ASL42N
5-pin		A5560N	
Shackle Height	1" (25mm)	1-1/8" (28mm)	3" (75mm)

Keying Options – Keyed Alike (KA), Keyed Different (KD), Master Keyed (MK)



DOOR KEY COMPATIBLE CYLINDERS AND PADLOCKS

SECURITY OPTIONS

Just one key can open them all. American Lock's door key compatible cylinders and padlocks mean the same key system can be used for all doors and padlocks—for greater key control, security, affordability and convenience.

- Padlock bodies accept the Edge® Key Control cylinder as well as the following OEM cylinders: Medeco® #20W20000 six-pin cylinder; Schlage® six-pin key-in-knob; Assa® #65611; Lori® #1539; and Schlage® Primus® and GMS® cylinders
- Changing keyways is easy—with many keyways available, most door security systems can be easily matched
- Recreate and/or expand any current key system using existing records
- Order cylinders both as part of a complete American Lock door key compatible padlock assembly, or separately, keyed up and ready to use
- WO comes standard with drivers to accommodate Medeco®, Lori®, 1539 and Schlage® cylinders



DOOR KEY COMPATIBLE PADLOCKS

With hardened boron alloy shackles, our door key compatible padlocks offer superior resistance against bolt cutters and prying, while the dual ball bearing locking mechanism resists pulling and prying. Padlocks are rekeyable, with replaceable cylinders and shackles.

Solid Steel Padlocks

Solid steel padlocks are made of hardened steel and are chrome plated—resisting cutting, sawing and corrosion.

For 3800 Series: body width=2-1/4" (57mm), body thickness=3/4" (19mm), shackle diameter=7/16" (11mm), and horizontal clearance=15/16" (24mm)

Solid Brass Padlocks

Solid brass padlocks are corrosion resistant and ideal for harsh environments. **Brass shackles available (B)**

For 3700 Series: body width=2" (50mm), body thickness=3/4" (19mm), shackle diameter=3/8" (10mm), and horizontal clearance=3/4" (19mm)

For 3600 Series: body width=1-3/4" (44mm), body thickness=3/4" (19mm), shackle diameter=5/16" (8mm), and horizontal clearance=3/4" (19mm)



Specifications	Models				
	A3800 A3700 A3700SS A3600 A3600SS	A3801 A3701 A3701SS A3601 A3601SS	A3702 A3602	A3605	
Shackle Height	1-1/8" (28mm)	2" (50mm)	3" (75mm)	5" (127mm)	

Keying Options – Keyed Alike (KA), Keyed Different (KD), Master Keyed (MK), BumpStop®, Edge®

WO – Without Cylinder

INTERCHANGEABLE CORES AND PADLOCKS

American Lock® offers small and large format interchangeable core padlocks designed to accept other manufacturer's cylinders so anyone can easily and affordably fit them into an established keying system. SFIC padlock bodies also will accept the following OEM cores: Arrow®, Best®, Best® PKS, Falcon®, Kaba® Peaks®, KSP® and Lori®.



- Changing cores is simple—match a door security system with 16 small format interchangeable core keyways, including Best®, Arrow® and Falcon®
- Recreate and/or expand a current key system using existing records
- Order cores both as part of a complete American Lock interchangeable core padlock assembly, or separately, keyed up and ready to use with any system

INTERCHANGEABLE CORE PADLOCKS

With hardened boron alloy shackles, our door key compatible padlocks offer superior resistance against bolt cutters and prying, while the dual ball bearing locking mechanism resists pulling and prying. Padlocks are rekeyable, with replaceable cylinders and shackles.

SMALL FORMAT INTERCHANGEABLE CORE PADLOCKS

Padlocks accept six- and seven-pin cores with no spacers required.

Solid Steel Padlocks

Solid steel padlocks are made of hardened steel and are chrome plated—resist cutting, sawing and corrosion. Available with Weatherbuilt™ Padlock Protection;

Stainless steel shackles available (SS)

For A3260 Series: body width=2" (50mm), body thickness=3/4" (19mm), shackle diameter=3/8" (10mm), and horizontal clearance=3/4" (19mm)

For A3200 Series: body width=1-3/4" (44mm), body thickness=3/4" (19mm), shackle diameter=5/16" (8mm), and horizontal clearance=3/4" (19mm)

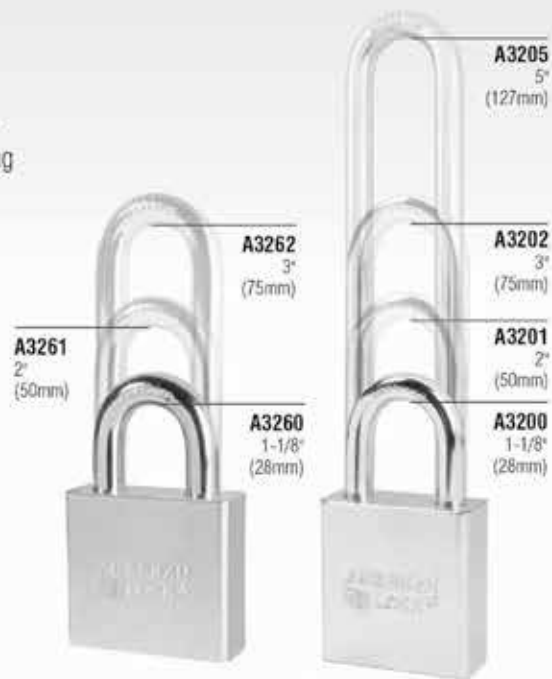

Specifications	Models			
	A3260 A3200	A3261 A3201	A3262 A3202	A3205
Shackle Height	1-1/8" (28mm)	2" (50mm)	3" (75mm)	5" (127mm)

Keying Options – Keyed Alike (KA), Keyed Different (KD), Master Keyed (MK)

Solid Brass Padlocks

Solid brass padlocks are corrosion resistant and ideal for harsh environments; available with Weatherbuilt™ Padlock Protection option.

Brass shackles available (B)

Stainless steel shackles available (SS)

For 3570 Series: body width=2" (50mm), body thickness=3/4" (19mm), shackle diameter=3/8" (10mm), and horizontal clearance=3/4" (19mm)

For 3560 Series: body width=1-3/4" (44mm), body thickness=3/4" (19mm), shackle diameter=5/16" (8mm), and horizontal clearance=3/4" (19mm)

Specifications	Models			
	A3570 A3560	A3571 A3561	A3572 A3562	A3565
Shackle Height	1-1/8" (28mm)	2" (50mm)	3" (75mm)	5" (127mm)

Keying Options – Keyed Alike (KA), Keyed Different (KD), Master Keyed (MK)

Solid Aluminum Padlocks

Solid aluminum padlocks are available in nine anodized finishes for easy identification, and are lightweight and spark and corrosion resistant, ideal for harsh environments. **Brass shackles available (B)**

For 3100 Series: body width=1-1/2" (38mm), body thickness=3/4" (19mm), shackle diameter=1/4" (6mm), and horizontal clearance=3/4" (19mm)

Specifications	Model		
	A3105	A3106	A3107
Shackle Height	1" (25mm)	2" (50mm)	3" (75mm)

Keying Options – Keyed Alike (KA), Keyed Different (KD), Master Keyed (MK)

LARGE FORMAT INTERCHANGEABLE CORE PADLOCKS

Solid Brass Padlocks: Schlage® Everest® and Primus®

Solid brass padlocks resist corrosion; A3900S series accepts Schlage® Everest® and Primus® cores. **Stainless steel shackles available (SS)**

For 3900 Series: body width=2" (50mm), body thickness=3/4" (19mm), shackle diameter=3/8" (10mm), and horizontal clearance=3/4" (19mm)

Solid Aluminum Padlocks: Yale®

Solid aluminum padlocks come in a variety of anodized finishes for easy identification, and are lightweight and spark and corrosion resistant, ideal for harsh environments; A1405 series accepts Yale® 1220 core.

For 1400 Series: body width=1-3/4" (44mm), body thickness=3/4" (19mm), shackle diameter=5/16" (8mm), and horizontal clearance=3/4" (19mm)

Specifications	Models				
	A1405	A3900S	A3901S A1406	A3902S A1407	A1409
Shackle Height	1" (25mm)	1-1/8" (28mm)	2" (50mm)	3" (50mm)	5" (127mm)

Keying Options – Keyed Alike (KA), Keyed Different (KD), Master Keyed (MK)



CAM LOCKS

UNIVERSAL MAILBOX LOCK

The Universal Mailbox Lock, with 9 included reversible cams and 90 degree operation, fits most apartment and group style mailboxes. The lock is available keyed different and has a secure 5-pin tumbler cylinder with two keys.

- Secure 5-pin tumbler cylinder
- 9 reversible cams in lengths from 1" (25mm) to 1-7/8" (48mm) and offsets from 1/64" (.4mm) to 1/2" (13mm)
- 90 degree operation
- Includes 2 keys per lock
- Keyed different
- Bright nickel finish

Specifications	Model
	APTCL6814A
Keying	Keyed Different
Finish	Bright Nickel
Cam Body Length	3/4"
For Door Thickness	1/2"
Cam Body Length (mm)	19"
For Door Thickness (mm)	13"



TUBULAR CAM LOCKS AND INNER CYLINDER LOCKS

Made of hardened steel, these seven-pin tubular cam and inner cylinder locks provide outstanding security, offer more than 50,000 key changes and meet National Automatic Merchandising Association (NAMA) requirements. The cam itself acts as a locking bolt and is directly operated when the key turns the plug. Circular seven-pin tumbler design deters picking and is suitable for laundry facilities, vending machine or arcade coin boxes, cabinets and desks, burglar alarms, currency chargers or cash drawers.

Tubular Cam Locks: Models A8068-A8148

- When fitted with a cam, available separately, the cylinders become a locking assembly
- Cylinders have threaded bodies on which appropriate mounting hardware can be used
- Removable zinc plated flat and offset cams allow versatile design applications

Inner Cylinder Lock: Model A8300

- Hardened steel face and locking bolt resist drilling and pulling
- Adaptable to most "pop out" door handle mechanisms



Specifications	Models				
	A8068	A8078	A8118	A8148	A8300
Overall Length	1-11/32" (34mm)	1-17/32" (39mm)	1-23/32" (44mm)	2-3/32" (53mm)	1-5/8" (41mm)
Maximum Latching Distance	11/16" (18mm)	15/16" (24mm)	1-1/8" (28mm)	1-1/2" (38mm)	1-3/32" (28mm)

Keying Options – Keyed Alike (KA), Keyed Different (KD)

DISC CAMS

American Lock disc cam locks can be used to secure office and laboratory furniture, appliances, tool and cash boxes, and more. They come in bright brass and bright nickel finishes, and each includes one flat cam and one reversible offset cam, 90 and 180 degree stop plates and mounting hardware. They're available keyed different and keyed alike.

Specifications	Models					
	ADCL3803	ADCL5803	ADCL7803	ADCL11803	ADCL13803	ADCL16803
Bright Brass	ADCL3803	ADCL5803	ADCL7803	ADCL11803	ADCL13803	ADCL16803
Bright Nickel	ADCL3814A	ADCL5814A	ADCL7814A	ADCL11814A	ADCL13814A	ADCL16814A
Disc Cam Length	3/8" (9mm)	5/8" (16mm)	7/8" (22mm)	1-1/8" (29mm)	1-3/8" (35mm)	1-3/4" (44mm)
Door Thickness	1/8" (3mm)	3/8" (9mm)	5/8" (16mm)	7/8" (22mm)	1-1/8" (29mm)	1-1/2" (38mm)
Maximum Latching Distance	23/32" (18mm)	31/32" (25mm)	1-7/32" (31mm)	1-15/32" (37mm)	1-23/32" (44mm)	2-3/32" (53mm)

Keying Options – Keyed Alike (KA), Keyed Different (KD)



HASPS AND LOCKING BOLTS

American Lock® heavy-duty, industrial grade steel hasps offer features to complement the strength of our padlocks. These hasps are a superior choice for commercial and industrial use on warehouses, utility rooms, storage buildings, van doors and vending machines.

- Hardened steel models resist cutting and sawing
- Choose from single- or double-hinged hasps for mounting to an internal or external corner, as well as straight bar, angle bar or circular shrouded vehicle hasps



HIGH SECURITY HASPS FOR HIDDEN SHACKLE PADLOCKS

- Hasps secure sliding and swinging doors on garages, storage buildings, vehicles, commercial buildings, industrial plants and vending machines
- Use with A2500, A2010 or A2001 or A2000 padlocks, featured on page 6
- Hasps are made of steel for maximum strength and durability
- A801 and A802 are designed so hidden shackle padlocks can be attached directly to the hasp for swing door applications, which adds security and convenience, and prevents loss of a loose padlock
- A802 secures overlapping trailer doors with a raised lip or seal
- Installation requires six 3/8" carriage bolts, washers and nuts. Due to variation in applications, mounting hardware not included

These hasps also are available with padlocks in bundle packs. Please see page 6.



A800



A800WHT

Specifications	Models			
	A800	A800WHT	A801	A802
Hasp Dimensions	9-1/16" x 4-1/2" (230mm x 114mm)	8-3/4" x 4-1/2" (222mm x 114mm)	8-3/4" x 4-1/2" (222mm x 114mm)	11-7/16" x 4-1/2" (291mm x 114mm)



A801



A802

HEAVY DUTY HASPS

- Hardened steel staple resists cutting, sawing and hammering
- Zinc plated hardened steel for added strength and weatherability
- Mounting hardware included for easy installation
- Models A850, A875, and A885 ideal for corners and angles



Specifications	Models				
	A535	A825	A850	A875	A885
Hasp Dimensions	5" x 2" (127mm x 50mm)	7-1/4" x 1-5/8" (184mm x 41mm)	4-1/4" x 1-5/8" (108mm x 41mm)	6-1/4" x 1-3/4" (159mm x 44mm)	7-3/4" x 1-3/4" (197mm x 44mm)



HEAVY DUTY GATE HASP

A810

- Use with A700, A5260 or A5200 padlocks
- Patent-pending gate hasp provides maximum security; for double-drive industrial gates with 1-5/8" or 2" frames
- Protects padlocks from cutting
- Simple four-bolt installation, with all mounting hardware included
- Adjustable slide fits gate openings from 3" to 6" wide
- Accepts padlocks with 7/16" diameter shackle and 1" vertical shackle clearance



LOCKING BOLT

A895

- 3/4" hardened steel locking bolt for maximum strength
- Chrome plated for corrosion resistance; mounting hardware included
- Fully adjustable from 3/4" to 2-3/8"
- Accepts padlocks with 7/16" diameter shackle
- Mounting hardware included

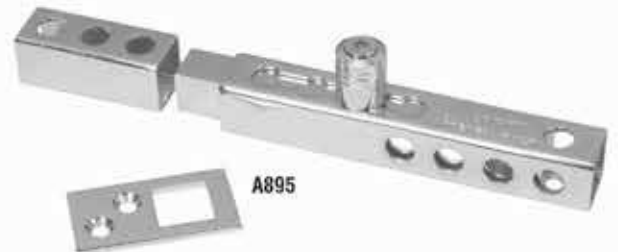

COMBINATION LOCKS

Our combination locks, for use on lockers, bicycles and utility cabinets, feature a stainless steel case and a three-number combination dial. They are available with key control for supervisory access.



patent no. 8,099,985

- Now featuring U.S. patented BlockGuard® Dual Protection Anti-Shim Technology; foreign patents pending. These enhanced combination locks feature a unique flat latch that deters shimming, a method of violating the lock by inserting a specially designed tool into its latch mechanism

- Automatic scrambler moves the dial upon shackle closing to ensure that lock is secure once closed
- Dial face available in blue, red, black, or green

For all: body width=2" (50mm), body thickness=3/4" (19mm), shackle diameter=9/32" (7mm), horizontal clearance=13/16" (21mm), and shackle height=3/4" (19mm)



DEALER RESOURCES AND SERVICE KITS

American Lock offers more than 30 popular padlocks and hasps packaged for showroom display. These keyed different items satisfy immediate customer security needs. Also available are compact rotating displays with preplanned product assortments, showroom product displays and signage.

1222DSPL Rotating Display - 2038 Product Kits available separately

2038ALSS American Lock Stainless Steel Spinner

2038LUBE Lock Lube Product Spinner

2038RES ProSeries Resettable Product Spinner

2038SPE Combination Padlock Product Spinner

ALCSIGN American Lock Backlit Sign

ALLOCKSIGN American Lock Header Sign 15" x 10"



2038ALSS



ALLOCKSIGN

Our lock service kits include critical component parts and service tools including pins, springs, shackles, cylinders, actuators, trap doors, key gauges and followers. With these kits, locks can be keyed and rekeyed to meet customer system requirements. The service parts are available separately to replenish kits.

ASK8 Pin Tumbler Service Kit

APK1 Pin Tumbler Pinning Kit

ATCR3 Tubular Keying Service Kit

AALSK18 Disc Tumbler Service Kit



ASK8