

MP119K - 11" Reversible Electric Cooling Fan-12volt, 90w motor

Mounting Instructions; Using Tie Kit

1. Peel backing and stick 4 rubber spacers on fan shroud as shown in **FIGURE 1**. Install the remaining 4 rubber spacers on the tie straps as shown in **FIGURE 2**.
2. Position fan on heat exchanger.
3. Make passageway through heat exchanger fins using #1 phillips screwdriver. Use hand pressure only, insuring the heat exchanger is not damaged.
4. Slide the tie strap through the mounting bracket, spacer, and heat exchanger as shown. Secure with plastic lock on opposite side of the heat exchanger as shown.
5. Fuse Fan To 15 Amps. Recommended Fuse Type is SAE ATC/ATO. Recommended Wire Gauge is 14.

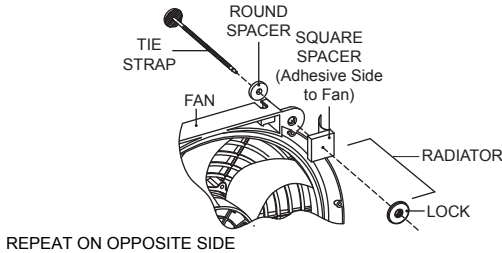

FIGURE 1

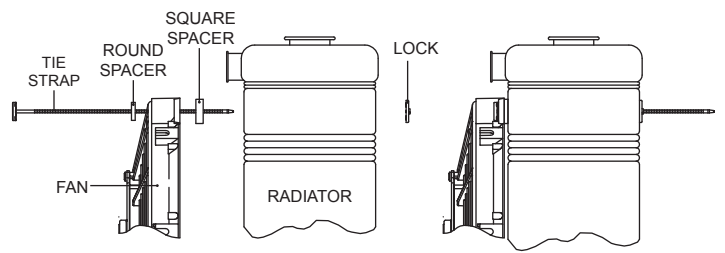

FIGURE 2

RECOMMENDATIONS:

It is the installer's responsibility to determine suitability for the individual application. It is recommended to periodically check the fan to make sure it has not become loose which can lead to damage of the heat exchanger.

We provide tie kits with all of our fans. However, for optimum mounting strength and performance we recommend using the MFA105 mounting kit on fans larger than 12" and/or 130 watts nominal.

Reversing Instructions:

1. Disconnect power to the fan. Remove nut as shown. Puller rotation is clockwise as shown in **FIGURE 3**.
2. Carefully pull the blade off the motor shaft. Caution - edges of blade are sharp. Do not try to drive the motor out by impact! This will destroy the motor and void the warranty. Flip the blade, then place back on the unit by lining up the hub center with the motor shaft. Blade will rest on spacers as shown in **FIGURE 4**. Be very carefull not to loose any of the spacers.
3. After seating blade, replace nut. Pusher configuration should look as shown in **FIGURE 5**. Note: Fan wiring changes to BLACK (+) POS and BLUE (-) NEG.

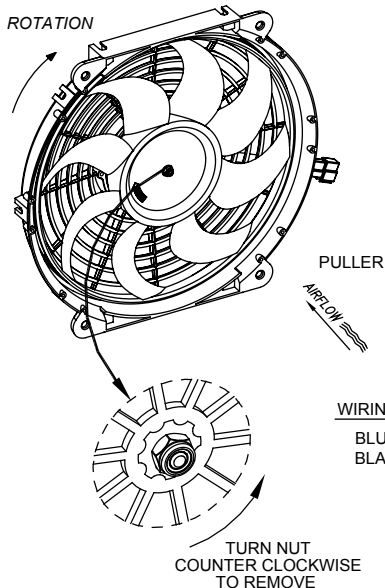

FIGURE 3

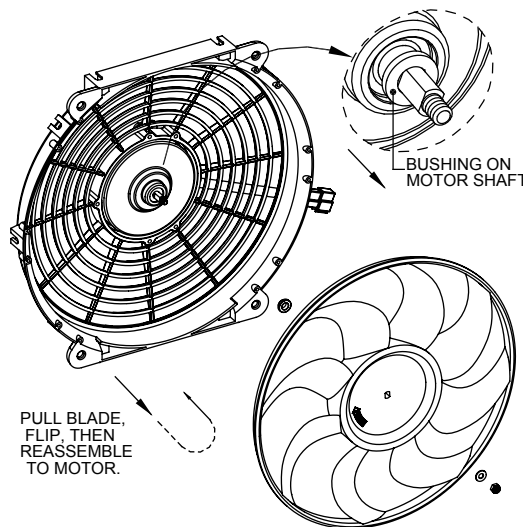

FIGURE 4

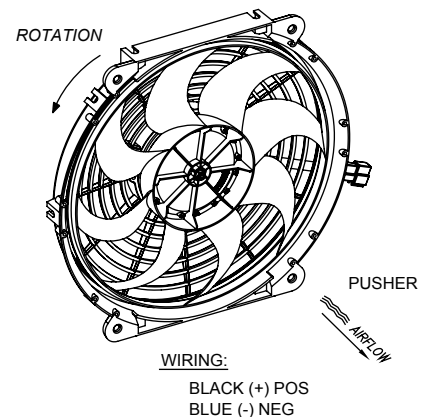

FIGURE 5