

M142K - 14" 225 Watt Fan Reversing & Mounting Instructions

BLADE REVERSING INSTRUCTIONS

Fans ship in puller configuration

1. Disconnect power to the fan. Place the tip of a flat blade screwdriver between the open end of the clip. Lift safety catch over shaft end and carefully push clip off the motor shaft.
2. With another person, carefully pull the blade off the motor shaft. We recommend one person hold the shroud and one person pull the blade. Caution – edges of the blade are sharp. Do not drive the motor out by impact. This will destroy the motor and void the warranty. Flip the blade, then place back on motor shaft by lining up the groove on the blade hub with the drive pin on the motor shaft.
3. Replace clip by pushing clip into groove on motor shaft. Ensure safety catch snaps over the motor shaft. Pusher configuration should look as shown.

MOUNTING INSTRUCTIONS

1. Avoid compressing the round shroud. Fan must remain circular to avoid blade contact within the shroud.
2. When mounting fans larger than 10 inches in diameter, Maradyne requires a spacing distance of 1/4" minimum between the face of the shroud and the heat exchanger surface. This protects against blade flex during vehicle acceleration or deceleration.
3. Mounting pins, tie straps, etc., through the heat exchanger are not recommended for fans larger than 12" in diameter. We recommend the use of our adjustable aluminum bracket set: Part number: MFA105 for these heavy duty fans.
4. Fuse each fan separately at 5 to 10 amps above their normal operating current draw. Each application is different, so proper value will vary.
5. Install fan caution label in the most visible location on the fan shroud.

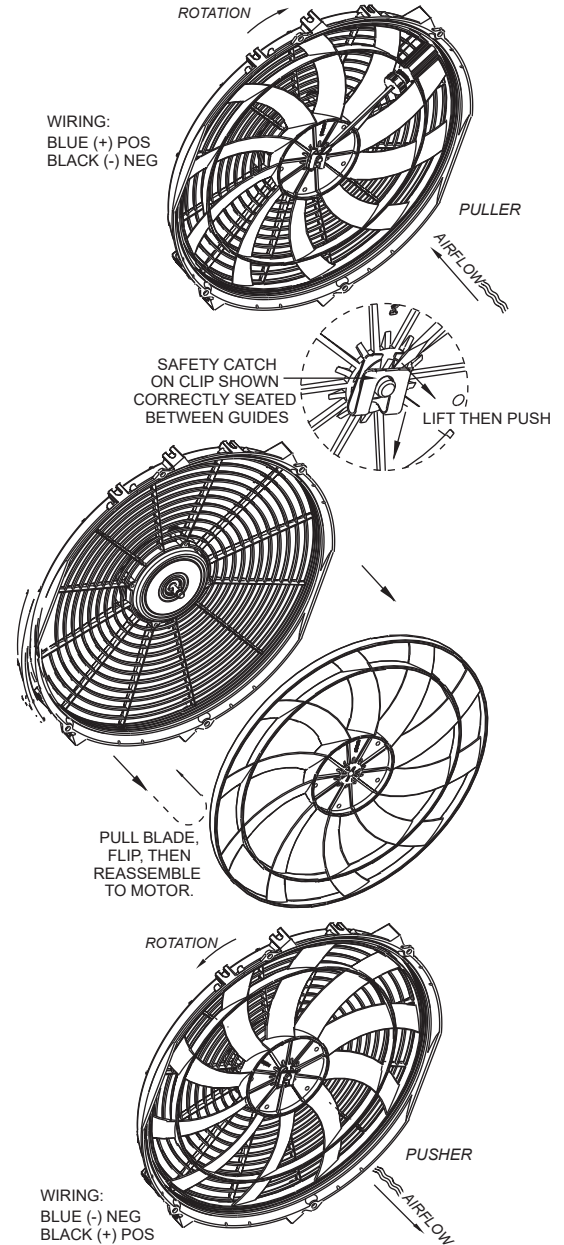

SPECIFICATIONS	M142K
Motor	225w
Current draw	17.2
CFM 0" static	2,135
Depth	3.19"

FAN MODEL NUMBER	RECOMMENDED WIRE GAGE	FUSE RATING	THE WIRE GAGE HAS BEEN SELECTED, BASED ON THE FUSE RATING WITH 14 GAGE MINIMUM. THESE WIRE SIZES ARE VALID FOR WIRE LENGTHS UP TO 15 FEET ON BOTH THE (+) & (-) MOTOR WIRES.
M142K	12	30	