

MALONE

- ~ RUNWAY SERIES
- ~ BACK OF CAR MOUNT BIKE RACK
- ~ 3 BIKE CAPACITY

MPG2142
REV 1



RUNWAY BC3

CHANGING THE WAY YOU GET THERE





Spare Part Listing

Product **Runway™ BC3**

Parent MPG/ER # MPG2142

Revision # A

Date: 9/26/2019

SKU #	DESCRIPTION	Image
<u>9214</u>	Strap with Hook, Black (MPG2139-2142), Set of 2	
<u>9222</u>	Strap With Hook, Red Protective Padding (MPG2133-2142), Single	
<u>9216</u>	Rubber Strap (MPG2142-2148), Set of 2	
<u>9223</u>	Retaining Strap, Red, Single (MPG2124-2127-2130-2139-2142-2147-2148)	

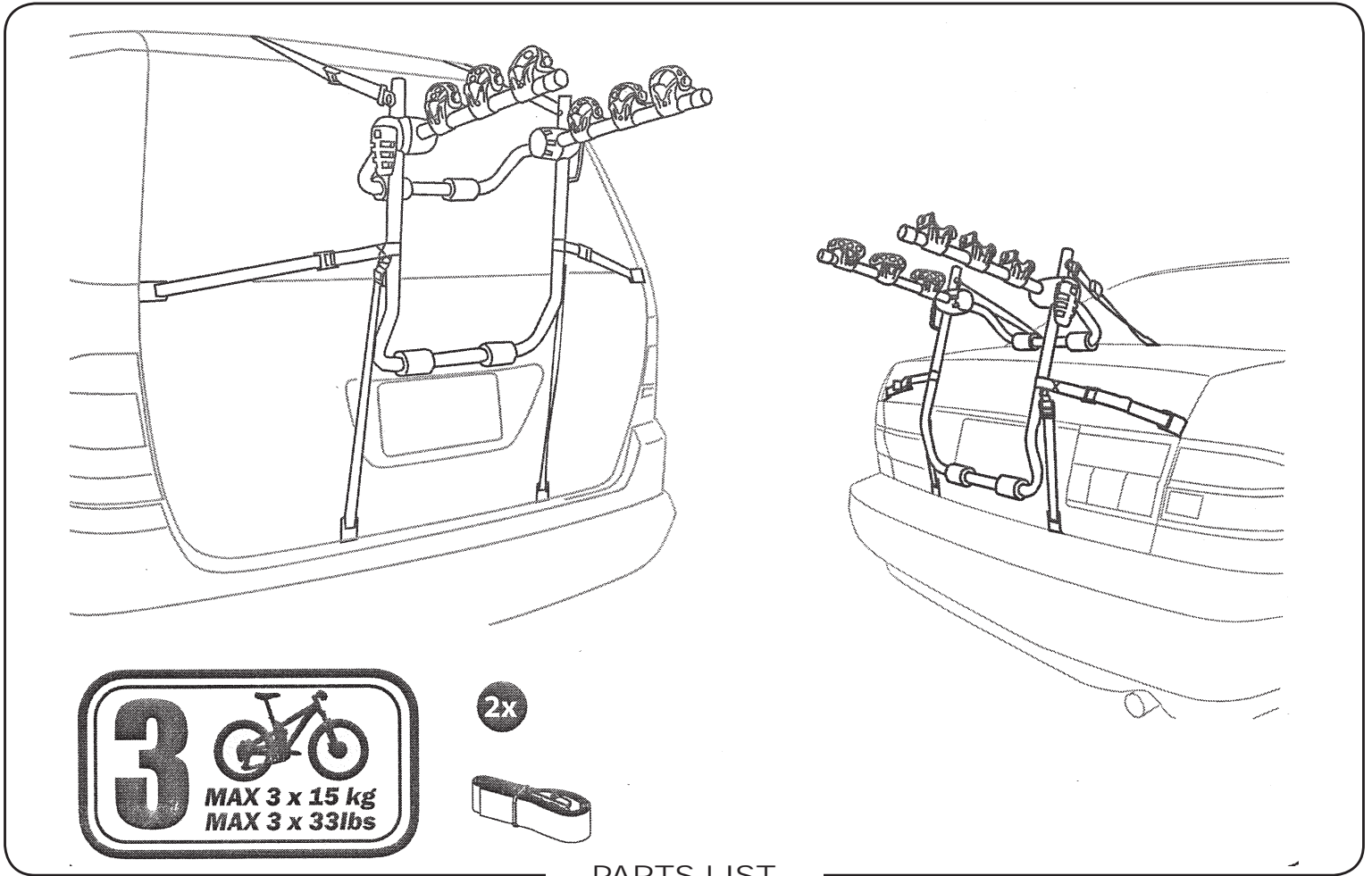

Installation & Loading Instructions - Please Read Before Beginning

IMPORTANT WARNING: All vehicular transports are potentially hazardous. Any person(s) using Malone products are personally responsible for following the given directions for use and/or installation and accepts full responsibility for any and all damages or injury of any kind including death, which may result from their use and/or installation.

It is critical that all Malone racks and accessories be properly and securely attached to your vehicle. Improper attachment could result in a serious accident, and could cause serious bodily injury or death to you or to others. You are responsible for securing the racks and accessories to your car, checking the attachment's prior to use, and periodically inspecting the products for adjustment, wear, and damage.

You must read and understand all of the instructions and cautions supplied with your Malone product(s) prior to installation or use. If you do not understand all of the instructions and cautions, or, if you have no mechanical experience and are not thoroughly familiar with the installation procedures, you should have the product installed by a professional installer.

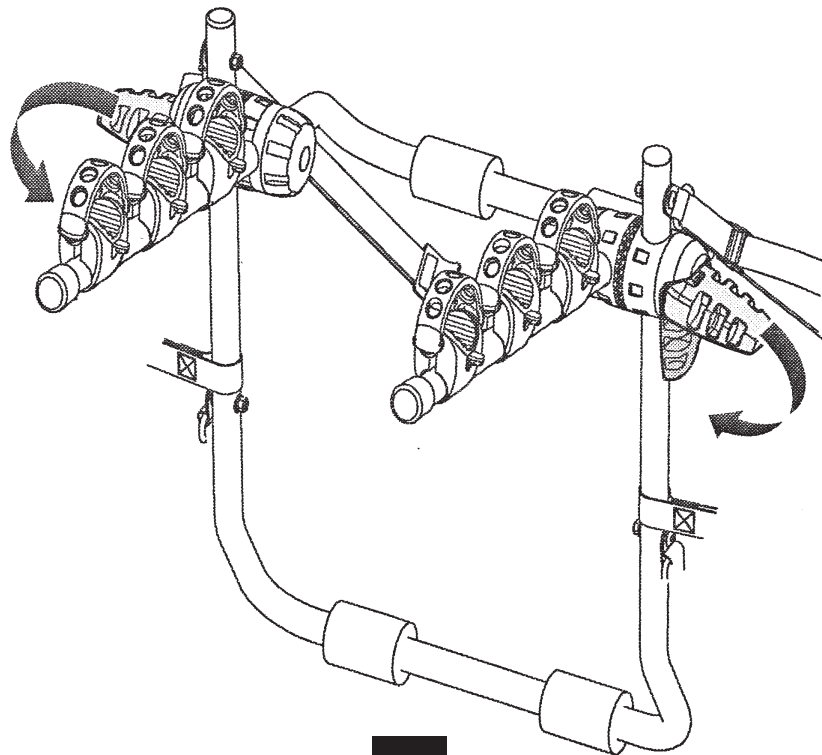
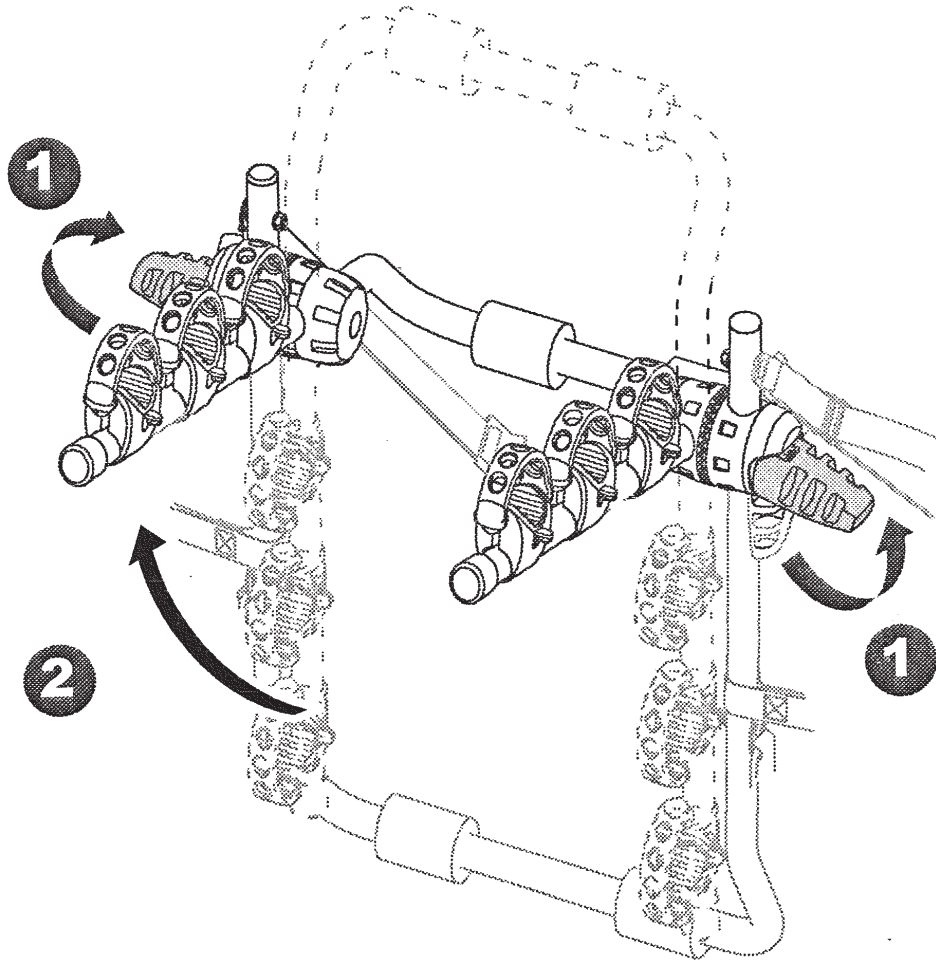

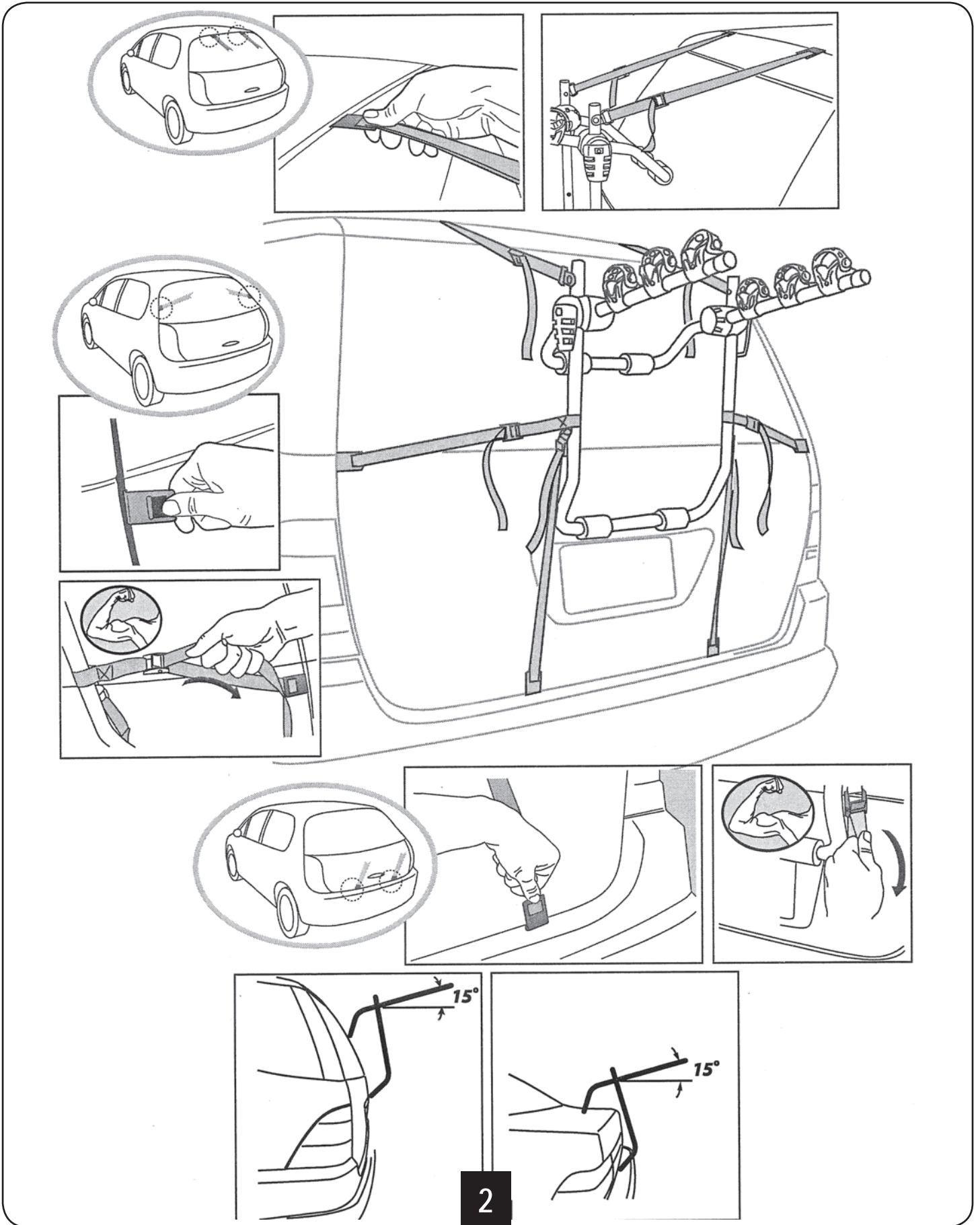

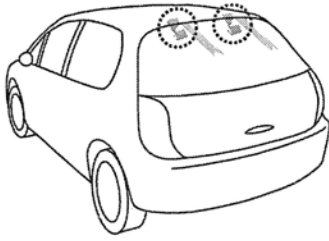

GB-US - Upper hooks specific mounting-Option 1

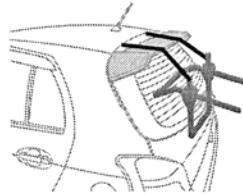
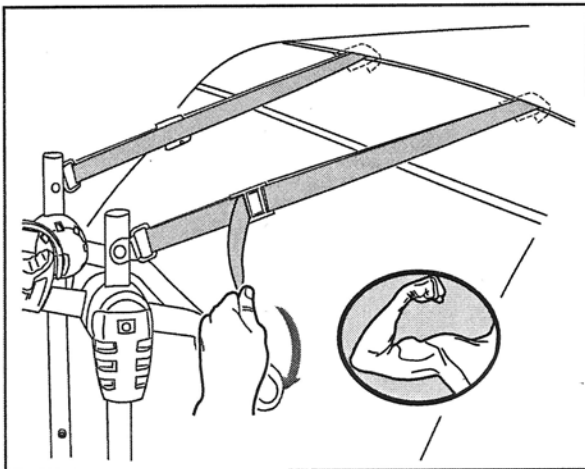
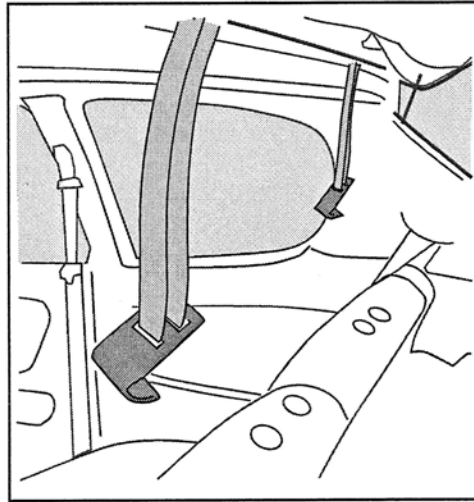
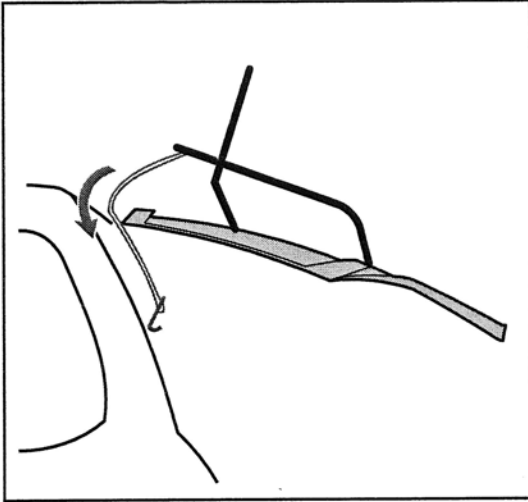

GB-US - it cannot fit the cars with a top plastic spoiler

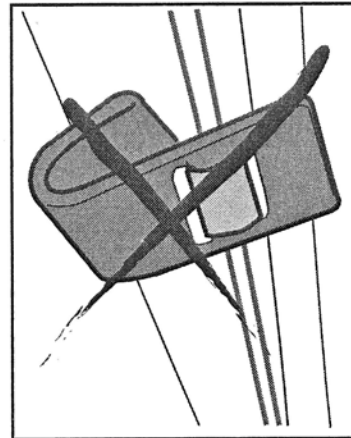
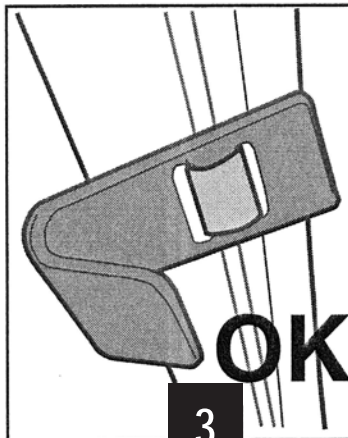
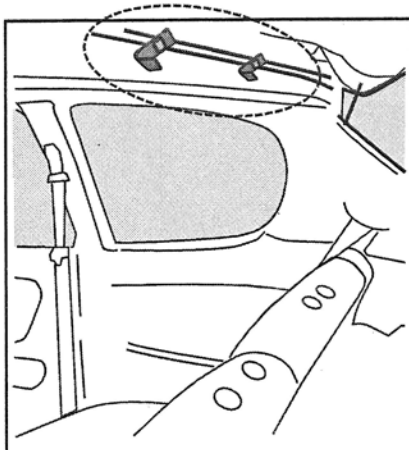

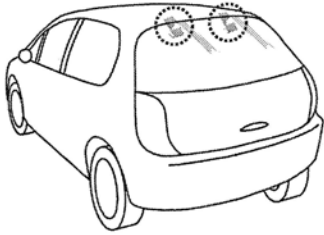

GB-US - Upper hooks specific mounting-Option 2

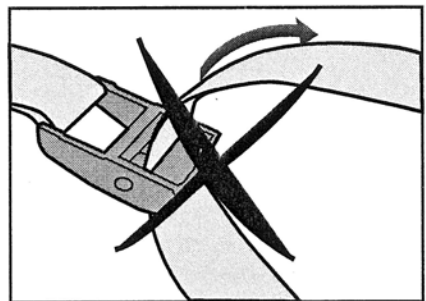
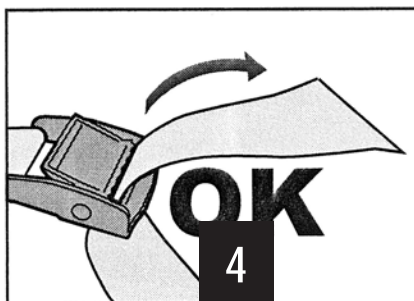
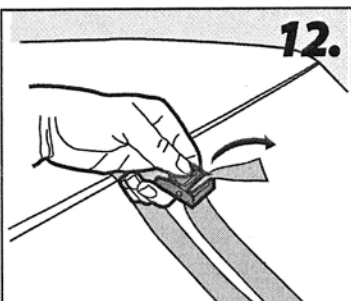
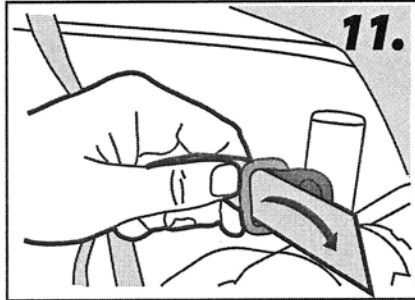
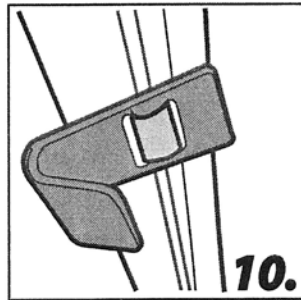
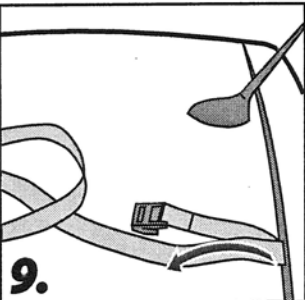
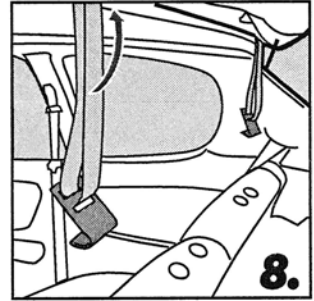
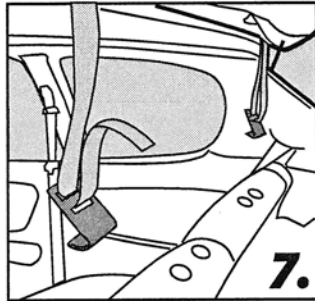
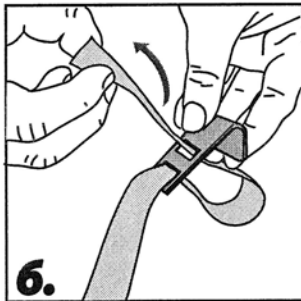
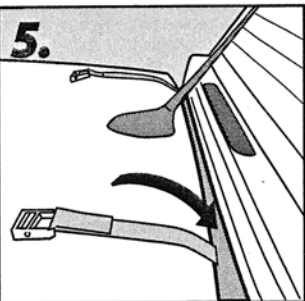
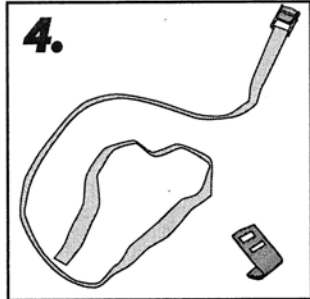
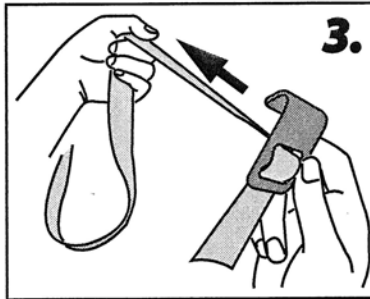
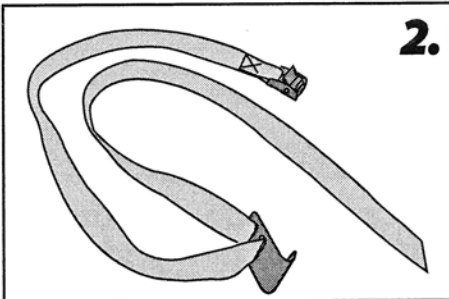
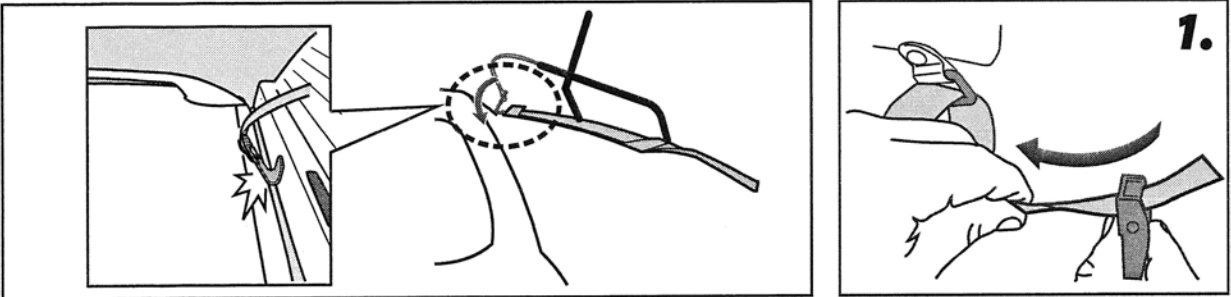

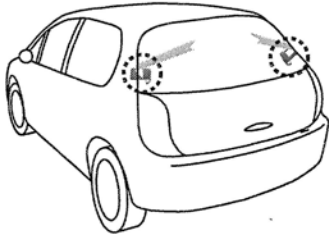

GB-US - Lateral straps specific mounting

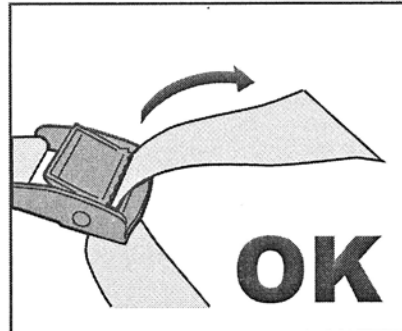
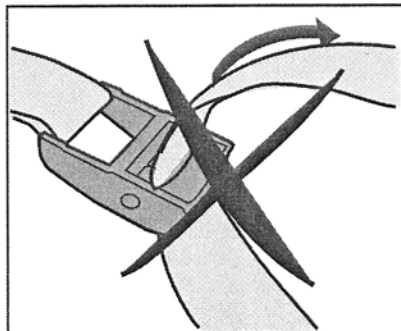
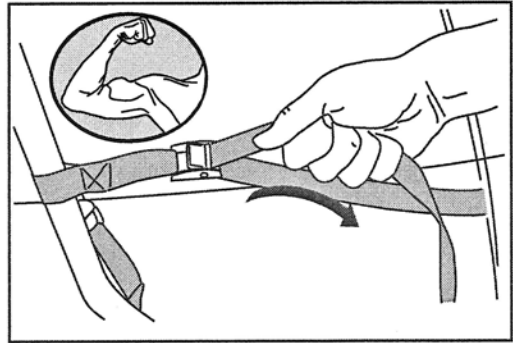
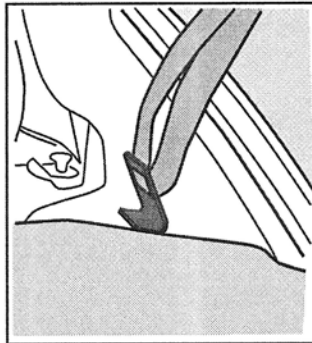
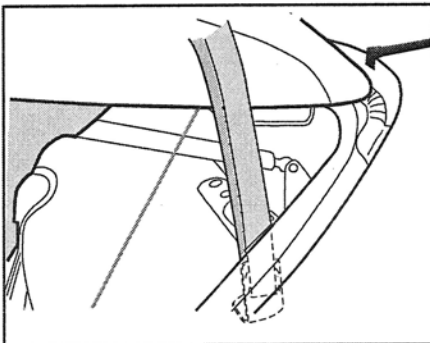
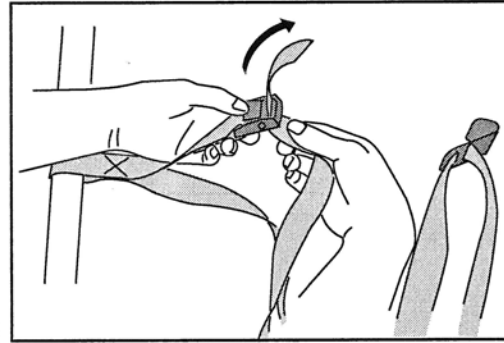
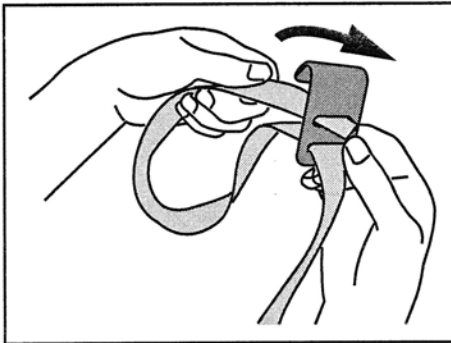
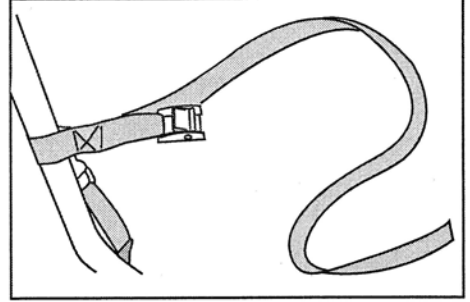
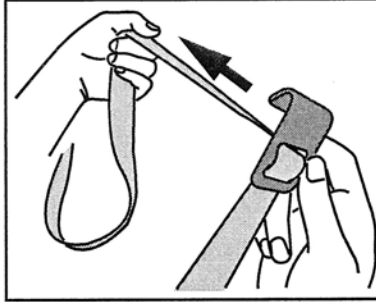
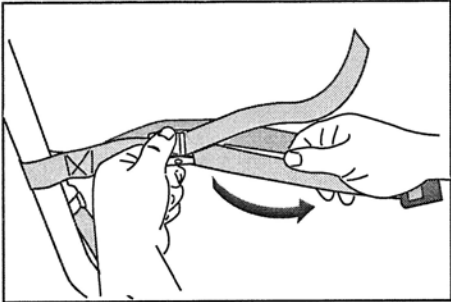

GB-US - Lateral and lower straps specific mounting

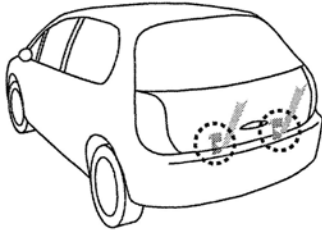

GB-US - Lower straps specific mounting

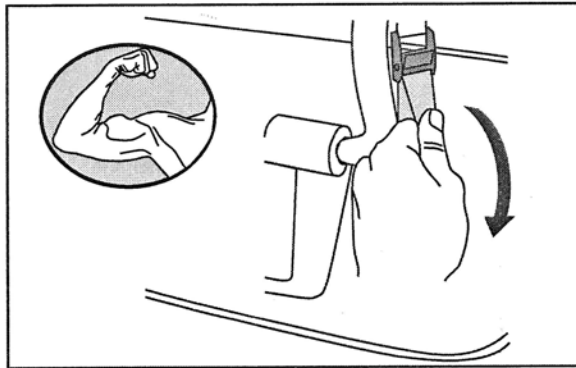
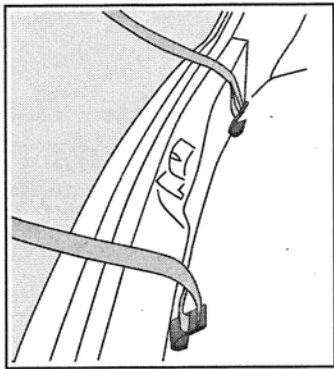

GB-US - Mounting of the bikes

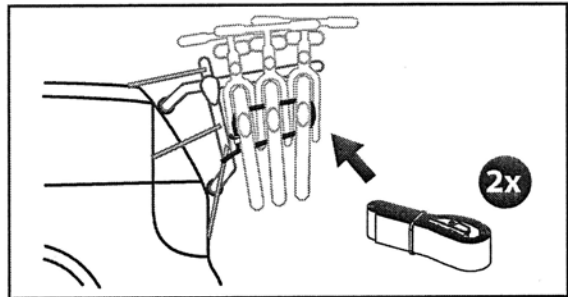
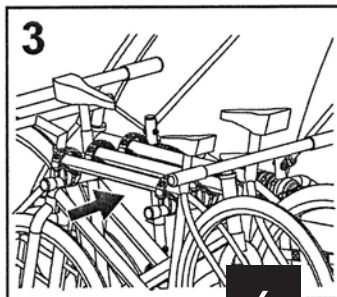
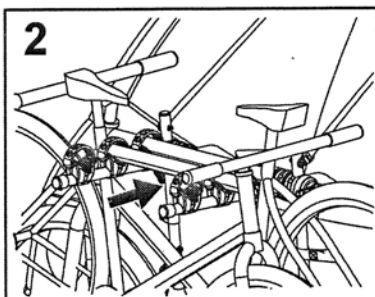
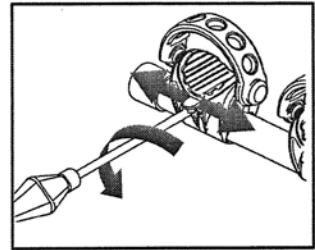
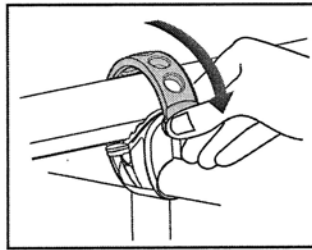
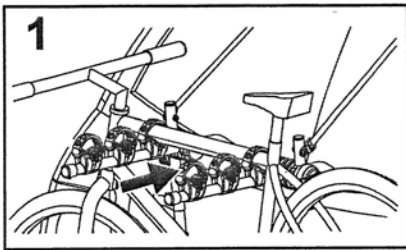

BIKE RACK WARNINGS

GENERAL REMARKS

Please read and observe the instructions carefully before you use the product, and keep them in a safe place for future use. Check the part list after opening the package. Make sure that all the parts are fully assembled according to the instruction before fitting it on your car.

The user is responsible for assembly and installation of this product, and the manufacturer disclaims any liability due to improper fitting or use of the product.

Failure to properly install this bike carrier and/or the bikes may cause damage to the vehicle and/or the bikes, and may result in personal injury. Do not use this product for purposes other than those for which it is designed. Do not modify any components of the product. Remove the carrier if not in use.

Do not use the carrier for more bikes than recommended. The weight of each bike cannot exceed 15kg/ 33lbs.

Do not install the carrier on campers, trailers or RVs.

This bike rack is not intended for transporting tandem, or recumbent bicycles.

Do not transport bicycles with attached baby seats, panniers, wheel covers, full bike covers or motors.

Depending on the shape of your bicycle, Malone cannot guarantee that it will fit properly on this carrier. You might have to use the Malone TopTube Adaptor, and use with bikes without a top tube/bar.

If using the Pilot series: make sure that the spare tire cover or tail lights of your car allows you to use this product. If you have any questions, please consult the store where you made the purchase.

Hitch mount racks are designed to fit in 1 ¼" (3.2cm) and 2" (5.1cm) receivers.

SAFE AND PROPER USE

Clean any surface areas of contact before installing any bike carrier.

Always use the safety strap to attach the bikes to the bike carrier.

Make sure the tailgate of your car allows you to use a trunk rack – some elements like spoilers, wind deflector may not allow you to use a trunk rack.

Metallic stabilizing/holding plates and hooks are to be attached to strong and rigid areas of the vehicle to ensure correct installation and weight distribution.

Check if the distance from the exhaust pipe to bicycles tires is safe for your bicycles or the straps of the carrier. The heat from the exhaust could damage the bike or bicycle racks.

Check if the rear wiper will interfere with the bike carriers before using it. If it does and it's an automatic, please disconnect it.

If your vehicle is equipped with an automatic tailgate opening system, disable this feature and open the door manually when using bike carriers.

When loading bicycles, remove all loose parts and accessories from bicycles (toolbags, baby carriers, pumps, etc.)

Always position the biggest/heaviest bike first and closest to the car, and then position the smaller bike(s) after that.

The user is responsible for periodically verifying that all hardware, straps, knobs, hubs are securely tightened for safety purposes.

You might have to use extra protections to protect the bikes and vehicles from scratches.

Do not open the gate with the bikes installed on the carrier when using trunk mounted carriers.

The locks used on this rack are theft deterrent.

When using a Hitch based rack, check that the hitch tube is properly fastened to the hitch receiver on the vehicle.

Verify that the safety pin is always inserted in the pin hole when the bike carrier is in the vertical position.

ROAD SAFETY

If the bikes and/or the carrier obstruct the vehicles tail lights and license plate, you must use an additional signal board.

The bicycle rack increases the vehicles length, and the bikes may increase its width and height. Be aware of this when passing through narrow or low clearance spaces and when reversing. Any loads exceeding the indicated dimensions must nevertheless respect existing regulations and be properly strapped down.

The load of rack and bicycles will affect driving. Do not exceed the speed limit, and do not drive faster than 120 km/h (75mph).

Drive slowly over speed bumps. Respect the speed limit, and adapt your speed to the condition of the road.

Off-road driving is not recommended and could result in damage to your vehicle, hitch receiver, bike carrier, or your bikes.

If you hit a bump or a hole in the road, stop your vehicle and inspect the bikes and carrier. If you notice anything wrong, remove the bikes and do not use the carrier.

Make sure there is a safe distance between the bikes and ground, especially when entering a driveway.

MAINTENANCE

Periodically inspect the product for signs of wear, corrosion, and fatigue.

Do not use the carrier with defective parts, contact the dealer to replace them before using it again.

Remove the product before entering a carwash.

To keep your product in the best condition, it is recommended to remove the product from the car when not in use. Please be advised this product is not designed to resist extreme weather conditions, especially seacoast air.

Lubricate the bolts in order to avoid corrosion.