



# INSTALLATION INSTRUCTIONS



FORD F-150

PART NO. 19563

## BILL OF MATERIALS:

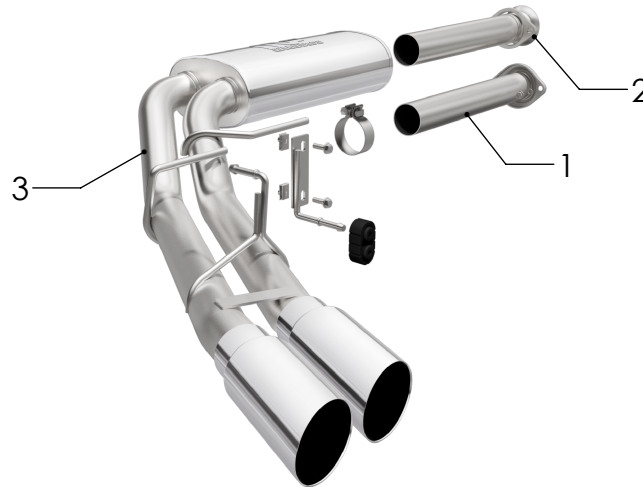

- 1. INLET PIPE ASSY '15-'20
- 2. INLET PIPE ASSY '21+
- 3. TAIL PIPE MUFFLER ASSY



WEAR SAFETY GLASSES



READ INSTRUCTIONS THOROUGHLY BEFORE INSTALLING PRODUCT



SPRAY LUBRICANT

To ease removal of existing exhaust components (especially on older vehicles) spray penetrating lubricant on all fasteners and hangers/insulators that will be loosened or removed and let soak before disassembly.

## HARDWARE KIT:

- 1. [1] HANGER BRACKET
- 2. [2] U-TYPE PANEL NUT
- 3. [2] M8-1.25 X 25mm BOLT
- 4. [2] M10-1.50 NUT
- 5. [2] M10 WASHER
- 6. [1] 3.00" TORCA CLAMP
- 7. [1] HANGER RUBBER
- 8. [1] 2-BOLT FLANGE

## MINIMUM REQUIRED TOOLS:



15 mm  
13mm



Hanger Tool  
(Or Pry Bar)

## MAGNAFLOW RECOMMENDS PROFESSIONAL INSTALLATION ON ALL THEIR PRODUCTS



**WARNING:** When working on, under, or around any vehicle exercise caution. Please allow the vehicle's exhaust system to cool before removal, as exhaust system temperatures may cause severe burns. If working without a lift always consult vehicle manual for correct lifting specifications. Always wear safety glasses and ensure a safe work area. Serious injury or death could occur if safety measures are not followed.

**ATTENTION:** Always install any supplied band or U-bolt clamps to the proper torque specifications of 40-45 ft-lb for band clamps and 30-35 ft-lb for U-bolt clamps. Over tightening will result in the clamps breaking and will NOT be warranted by MagnaFlow.

## INSTALLATION INSTRUCTIONS

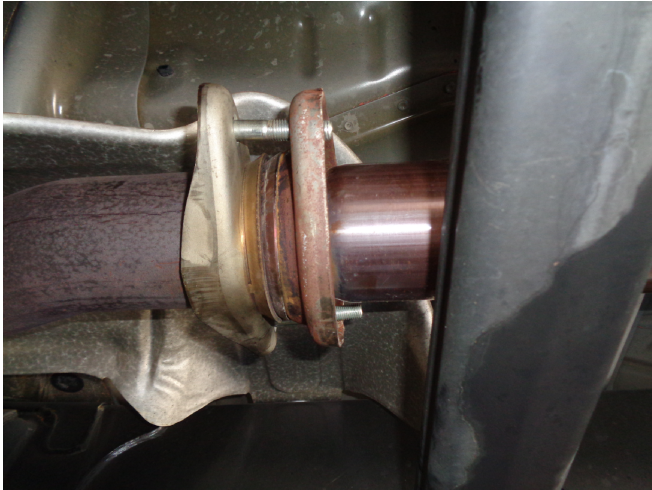

**Step 1.** To remove the OEM exhaust system, you will need to unbolt the muffler assembly from the flange junction as shown.

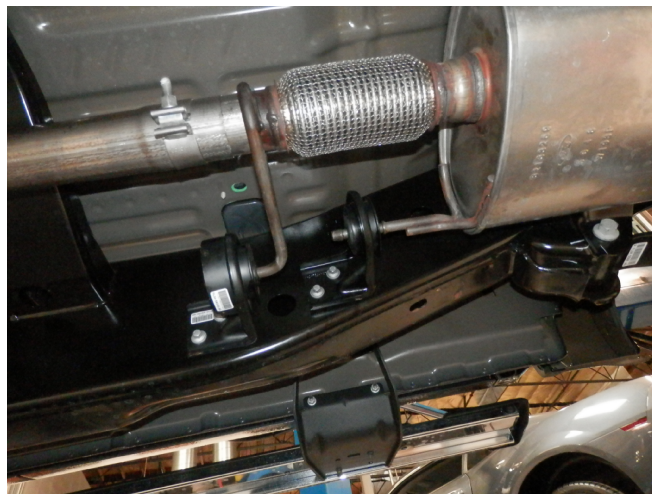

**Step 2.** Unbolt the clamp just behind the muffler. Disengage the welded hangers from the rubber insulators. Remove the OEM exhaust system. Do not damage or discard the OEM fasteners or rubber insulators as they will be reused to mount your new MAGNAFLOW system.

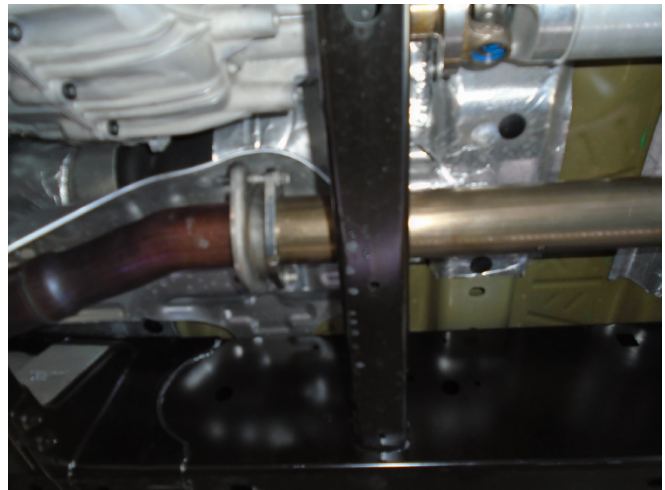

**Step 3.** Your new MAGNAFLOW system comes with two inlet pipe assemblies. The assembly that has the flange welded to it is for year spread 2015 - 2020. The pipe without the flange will use the slip flange in the hardware kit and is for years 2021. Loosely attach the correct pipe assembly for your year of vehicle using either the OE hardware or the supplied hardware.

## INSTALLATION INSTRUCTIONS

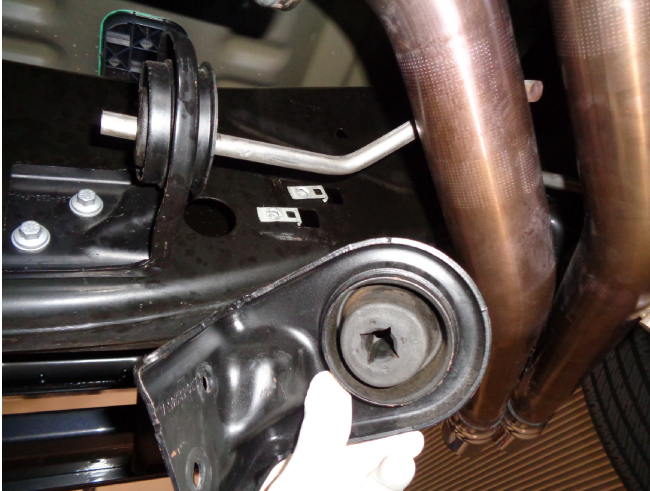

**Step 4.** Before installing the Muffler Assembly there is an OEM rubber insulator assembly bolted to the subframe that may need to be removed before installing the Muffler Assembly. If your vehicles engine is 2.7L or 3.5L you will need to remove the rubber insulator assembly. If you have the 5.0L leave the rubber insulator intact.

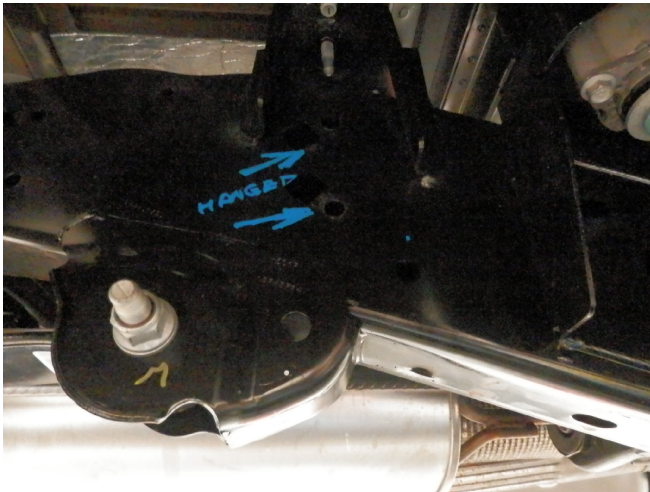

**Step 5.** Locate the two square holes in the passengers side of the vehicles subframe. Attach the two supplied U-Type panel nuts as shown in the diagram. Loosely bolt the supplied Hanger Bracket Assembly to the panel nuts using the supplied bolts.

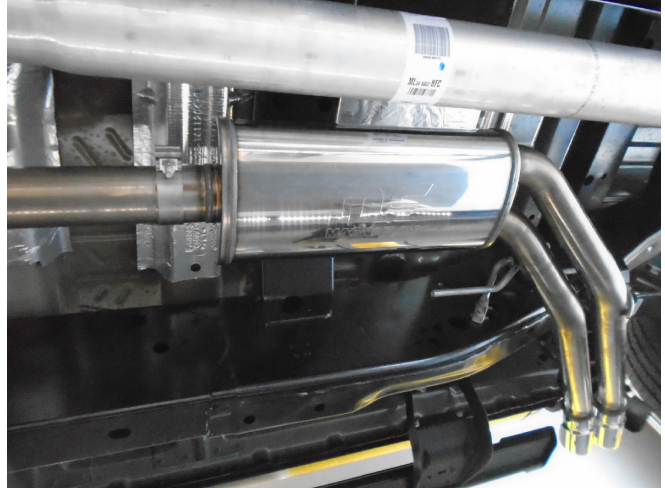

**Step 6.** Install the Muffler Assembly and loosely secure using the supplied 3.00" clamp. Attach the installed Hanger Bracket Assembly to the welded hanger using the supplied rubber insulator.



**Step 7.** Once a final position has been chosen for the new exhaust system, evenly tighten all clamps from front to rear using the torque specifications on page one of these instructions. Inspect all fasteners after 25-50 miles of operation and re-tighten if necessary.