



# INSTALLATION INSTRUCTIONS



MUFFLER xMOD 5x8x18 2.5/2.5 | PART NO. 14006

## BILL OF MATERIALS:

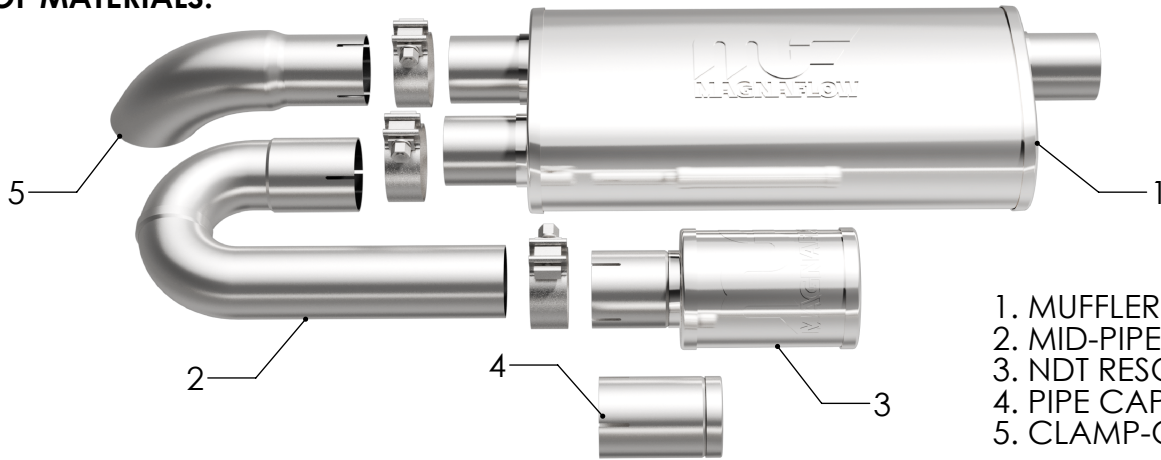

- 1. MUFFLER ASSY
- 2. MID-PIPE ASSY
- 3. NDT RESONATOR
- 4. PIPE CAP ASSY
- 5. CLAMP-ON TIP



WEAR SAFETY GLASSES



READ INSTRUCTIONS THOROUGHLY BEFORE INSTALLING PRODUCT



SPRAY LUBRICANT

To ease removal of existing exhaust components (especially on older vehicles) spray penetrating lubricant on all fasteners and hangers/insulators that will be loosened or removed and let soak before disassembly.

## HARDWARE KIT:

- 1. [3] 2.50" Clamp

## MINIMUM REQUIRED TOOLS:



Saw (Or Other Cutting Tool)



15 mm



Hanger Tool (Or Pry Bar)

## **MAGNAFLOW RECOMMENDS PROFESSIONAL INSTALLATION ON ALL THEIR PRODUCTS**



**WARNING:** When working on, under, or around any vehicle exercise caution. Please allow the vehicle's exhaust system to cool before removal, as exhaust system temperatures may cause severe burns. If working without a lift always consult vehicle manual for correct lifting specifications. Always wear safety glasses and ensure a safe work area. Serious injury or death could occur if safety measures are not followed.

**ATTENTION:** Always install any supplied band or U-bolt clamps to the proper torque specifications of 40-45 ft-lb for band clamps and 30-35 ft-lb for U-bolt clamps. Over tightening will result in the clamps breaking and will NOT be warranted by MagnaFlow.

# INSTALLATION INSTRUCTIONS

It is necessary to remove your stock muffler to replace it with the xMod universal muffler kit. Select cut points bearing in mind the overall length of the replacement Muffler Assembly. Inlet "A" is to be welded to the OE exhaust outlet after cutting. Outlet "B" is to attach to the cut OE tail pipe or the supplied Clamp-On Tip.

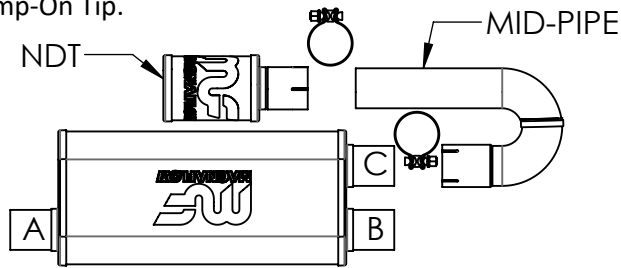

**CONFIGURATION # 1**

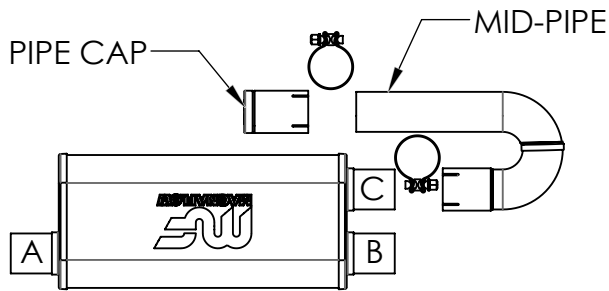

**CONFIGURATION # 2**

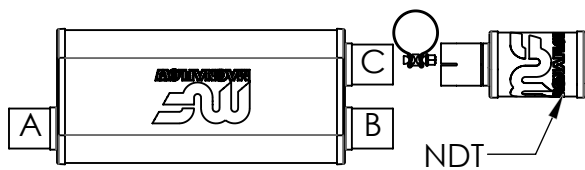

**CONFIGURATION # 3**

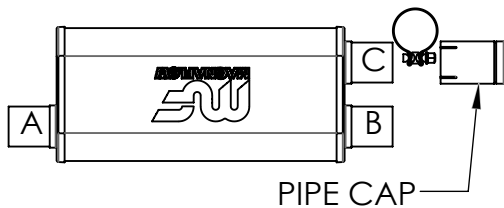

**CONFIGURATION # 4**

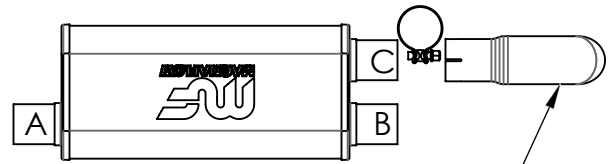

**CLAMP-ON TIP**

**CONFIGURATION # 5**

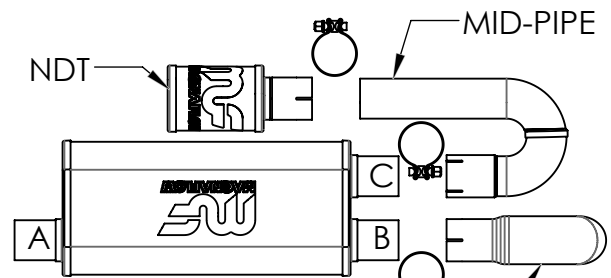

**CLAMP-ON TIP**

**CONFIGURATION # 6**

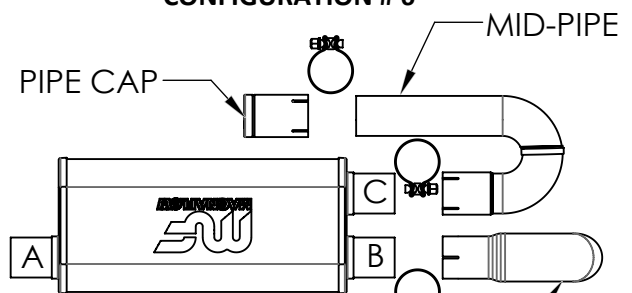

**CLAMP-ON TIP**

**CONFIGURATION # 7**

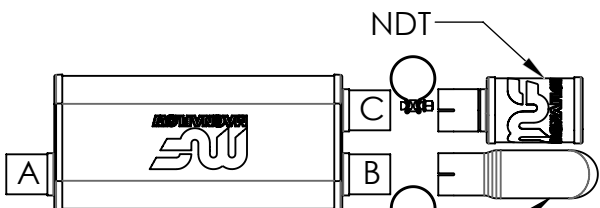

**CLAMP-ON TIP**

**CONFIGURATION # 8**

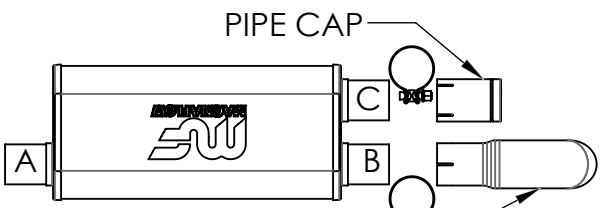

**CLAMP-ON TIP**

**CONFIGURATION # 9**