

SINCE 1994



mac's

ISSUE

NO. 9



TIE-DOWN SYSTEMS ADJUSTABLE

1' VERSATIE™ TRACK KIT

522012

2' VERSATIE™ TRACK KIT

522024

4' VERSATIE™ TRACK KIT

522048

6' VERSATIE™ TRACK KIT

522072

8' VERSATIE™ TRACK KIT

522096

JEEP® TRACKS™

TJ Wrangler®	522938
TJ Wrangler® Unlimited (LJ)	522928
2 Door JK Wrangler®	522941
4 Door JK Wrangler®	522928

EXTRAS:

TRACK 1 BILLET ARROWHEAD

463101



SINGLE STUD RING

310001



JEEP® TRACKS™

Mac's new Jeep Tracks™ utilize the stock holes and hardware (no drilling required) for mounting your hardtop in your TJ and JK Wrangler® - now your cooler will stay secured as you roll down the hill. Works equally as well with soft-top Jeeps®. Works with or without the top in place.

INCLUDES

- (2) Lengths of Track
- (4) Single Stud Rings
- Stainless Attachment Hardware



VERSATIE™ TRACK KITS

Mac's VersaTie™ Track Kits are convenient all-in-one track packages. We provide everything from the track to the single stud tie-down rings as well as stainless steel fastener sets for the precision drilled and countersunk mounting holes. We use stainless steel to prevent electrolysis and rust, keeping your tie-down solution solid for many years to come. In typical Mac's style, we provide a more secure nylon insert nut (as opposed to a simple nut) to assure a lasting installation.

VERSATIE KITS INCLUDE

- (2) Lengths of Mac's VersaTie™ Track-1
- (2) Single Stud Tie Down Rings (The 4' and Longer Kits Come with 4 Rings)

All Required Stainless Steel 1.5" Hardware





TIE-DOWN SYSTEMS ADJUSTABLE

4 VERSATIE™ ANCHOR
PLATE ASSEMBLIES
INCLUDED WITH FLOOR
AND RAIL TRUCK KIT



BACKING PLATE VIEW



TRUCK TRACKS™

Mac's Truck Tracks™ are the perfect adjustable tie-down system for any truck. It's versatile enough for any load – bikes, construction materials, mixed loads – and it's stronger than the bed itself. If your truck can take the weight, Mac's Truck Tracks keep it in place. Unlike competitive systems that slide, VersaTie™ fittings can be removed and replaced with only 1/2" travel. No need to slide the fitting to the end of the bed to remove it. Cleaning is a breeze, too – the surface can be maintained with a scuff pad and the channel blown out with an air hose. Remember – your truck isn't fully loaded 'til it's got Truck Tracks™.

TRUCK TRACKS™ INCLUDE

- (2) Bed Rails
- (4) Removable Single Stud Tie Down Rings
- All Stainless Steel 1" Mounting Hardware

TRUCK TRACKS™ FLOOR AND RAIL INCLUDE

- (2) Bed Rails
- (4) Removable Single Stud Tie Down Rings
- Four point VersaTie™ Pack
- All Stainless Steel 1" Mounting Hardware

TRUCK TRACKS™

Full Size Long Bed Ford/Dodge/GM
521001

Full Size Short Bed Ford
521002

Full Size Short Bed Dodge/GM
521003

Extra Single Stud Rings (each)
310001

TRUCK TRACKS™ FLOOR AND RAIL

Full Size Long Bed Ford/Dodge/GM
521004

Full Size Short Bed Ford
521005

Full Size Short Bed Dodge/GM
521006

Front Track, With Two Single Stud Rings
210001

Quality Nutsert Tool
748699

Disposable Nutsert Tool
748601

1/4" Stainless Steel Nutsert (each)
486014

Extra Single Stud Rings (each)
310001





TIE-DOWN SYSTEMS ADJUSTABLE

VERSATIE™ TRACK

Mac's superior quality VersaTie™ Track allows complete customization of your tie-down systems. The clean, high-strength track allows flexibility of installation, and adjustable tie-down positions in one-inch increments. Aircraft quality aluminum extrusions are fully CNC machined for secure connections. Track can be flush or surface mounted on interior or exterior surfaces by riveting, bolting, screwing, gluing, or welding. Perfect for floor, wall, ceiling, and roof mounting.

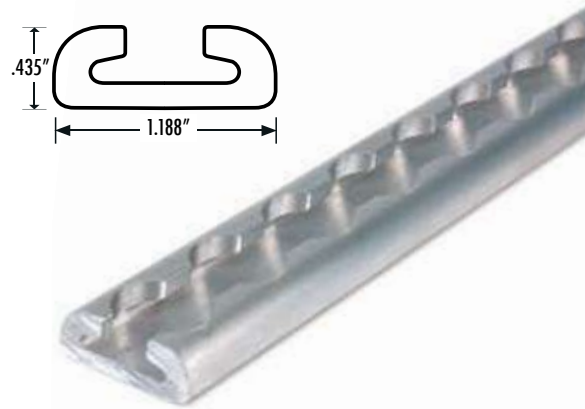

VERSATIE™ TRACK 1

The clean, contoured edges of this track make it perfect for surface mounting and easy installation.

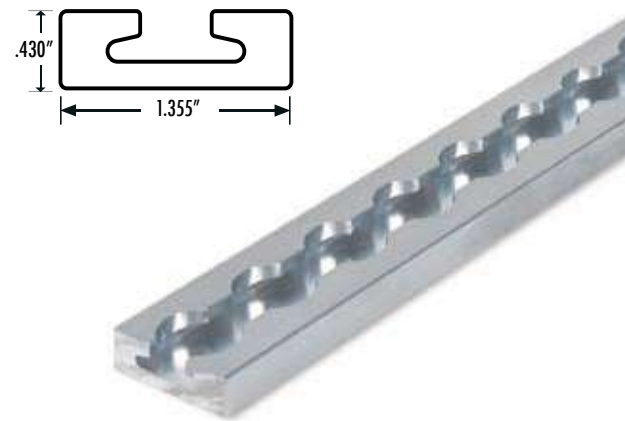

VERSATIE™ TRACK 2

The square-edged extrusion is ideal for recessed mount installation where a smooth, flush finish is required.

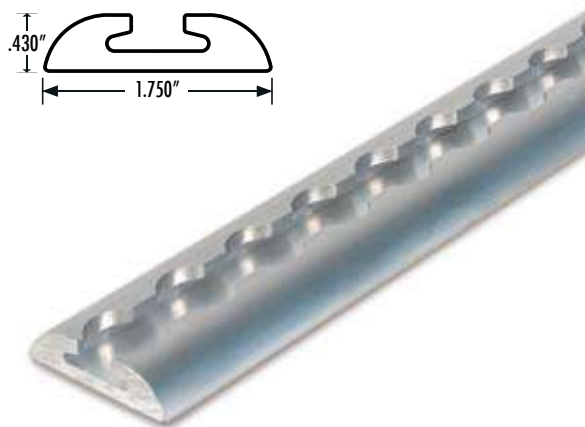

VERSATIE™ TRACK 3

The wider contoured extrusion provides a smoother transition for surface mounted track.

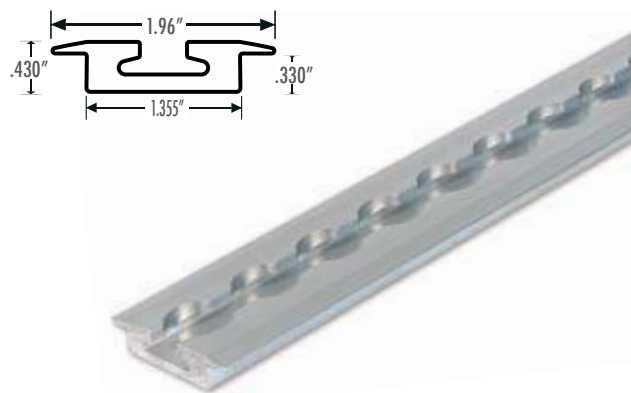

VERSATIE™ TRACK 4

Designed for recessed mounting where the wide, smooth, contoured flange will cover cut edges for a clean finish.



ARROWHEAD FOR VERSATIE™ TRACK

Finish off your track section with our our billet aluminum arrowhead track ends.



VERSATIE™ FILLER TRACK

Mac's Filler Track is made of tough extruded vinyl and designed to fill the empty channel of VersaTie™ track to keep it free of debris. (Note: Filler track is only recommended for track that has been recessed.)

LENGTH	SHIPPING	NUMBER
--------	----------	--------

VERSATIE™ TRACK 1		
96"	Ships FedEx .	210096
192"	Truck Freight Only	210192

VERSATIE™ TRACK 2		
96"	Ships FedEx .	220096
192"	Truck Freight Only	220192

VERSATIE™ TRACK 3		
96"	Ships FedEx .	230096
192"	Truck Freight Only	230192

VERSATIE™ TRACK 4		
96"	Ships FedEx .	240096
192"	Truck Freight Only	240192

VERSATIE™ FILLER TRACK (BLACK ONLY)		
8'	Ships FedEx .	310007

ARROWHEAD FOR VERSATIE™ TRACK			
Track 1	Track 2	Track 3	Track 4
463101	463201	463007	463401

MACS TECH TIP

VersaTie™ Track Load Capacities How to Use the Chart*

It is important not to exceed the load capabilities of the track. Below are listed maximum load capabilities of the track calculated using a double stud ring at varying angles. All tracks were tested using 1/4" flat head screws fastened every two inches. Please review the installation safety notes in this brochure for safe tie-down procedures. Note: x°/y° where x° = angle from centerline of track, y° = vertical angle of pull.

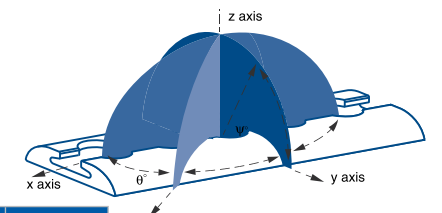

Track	0°/0°	0°/30°	0°/60°	0°/90°	45°/0°	45°/30°	45°/60°	90°/0°	90°/30°	90°/60°
VT-Track-1	4995	4710	7010	6075	5935	4610	5185	3935	3460	4565
VT-Track-2	8150	7275	9000	10800	10150	7238	7825	7425	6475	7200
VT-Track-3	6572	5992	8005	8042	8042	5924	6505	5680	4967	5882
VT-Track-4	8150	7275	9000	10800	10150	7238	7825	7425	6475	7200



TIE-DOWN SYSTEMS ADJUSTABLE

VERSATIE™ CONNECTORS

Mac's VersaTie™ Connectors provide fast, secure tie-down points at one-inch increments in any profile of VersaTie™ Track. Easy to use, the fasteners can be quickly positioned along tracks anywhere they are needed.

CAPACITY NUMBER

SINGLE STUD TIE DOWN RING

3,000 lb* 310001

DOUBLE STUD TIE DOWN RING

5,000 lb* 310002

DOUBLE STUD IDLER FITTING

5,000 lb* 310003

DOUBLE STUD FITTING W/ PEAR-SHAPED RING

5,000 lb* 310004

VERSATIE™ THREADED STUD

5,000 lb* 310008

4 PRONG KNOB*

472003



COOL DEAL:

Mac's can sew this hardware right onto your straps, minimizing the amount of metal that comes near your vehicle. Also great for ultra low clearance applications.

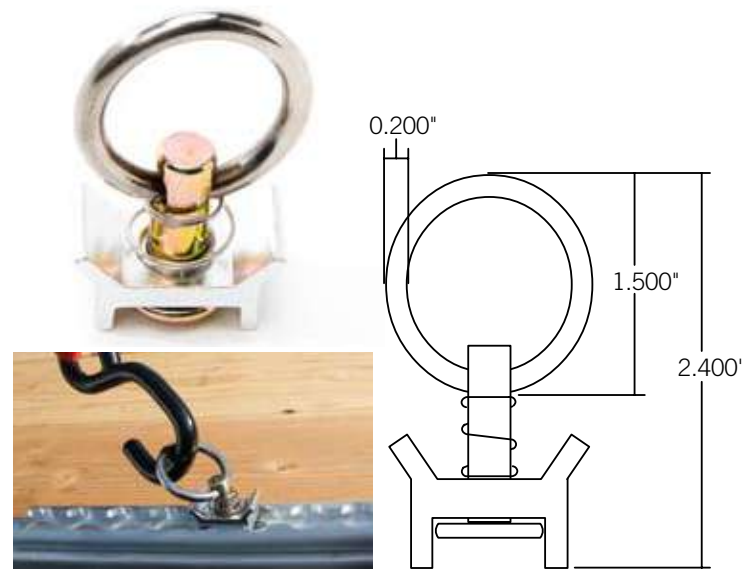

SINGLE STUD TIE DOWN RING

This VersaTie™ connector has a cadmium-plated alloy steel stud, anodized aluminum body and stainless steel ring for quick, secure one-hand installation. Ring tilts and rotates full 360 degrees.

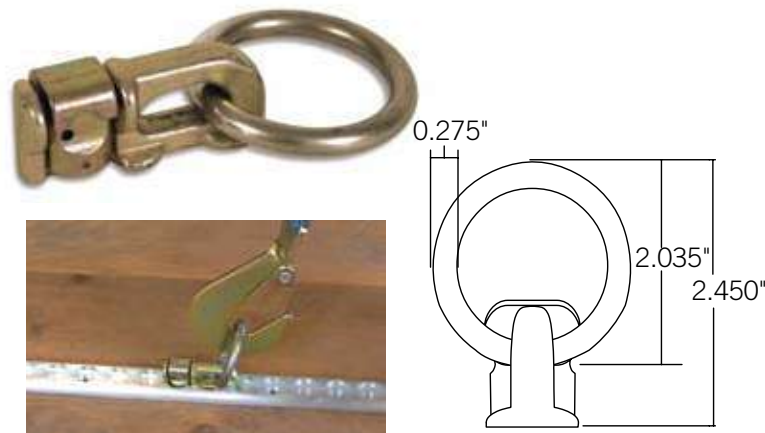

DOUBLE STUD TIE DOWN RING

For maximum strength loads, this fitting utilizes a dual stud connection and high-strength stainless steel ring. Excellent for vehicle tie-down applications.



DOUBLE STUD IDLER FITTING

This triangular ring is set up for a 2" strap to run through the flat edge. Use this tool to get around air dams, close fenders, and diffusers. Triangle design allows for pulling off-angle.

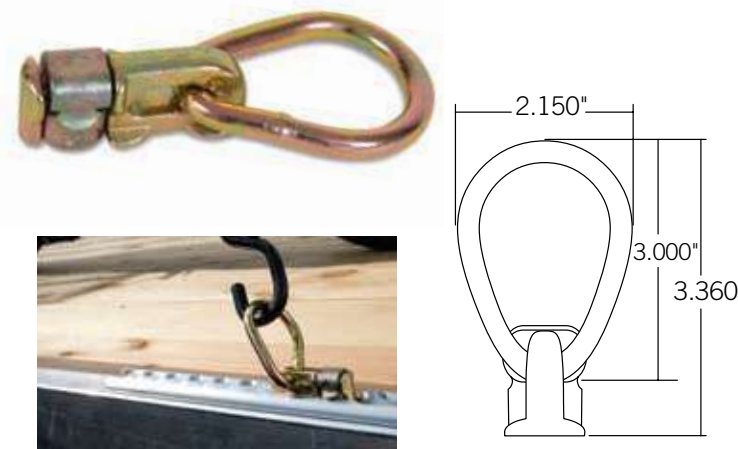

DOUBLE STUD FITTING WITH PEAR SHAPED RING

This fitting utilizes a "pear" ring that allows it to be pulled off angle from the track. Ideal for applications where the track is installed close to obstructions such as cabinets, walls, etc.

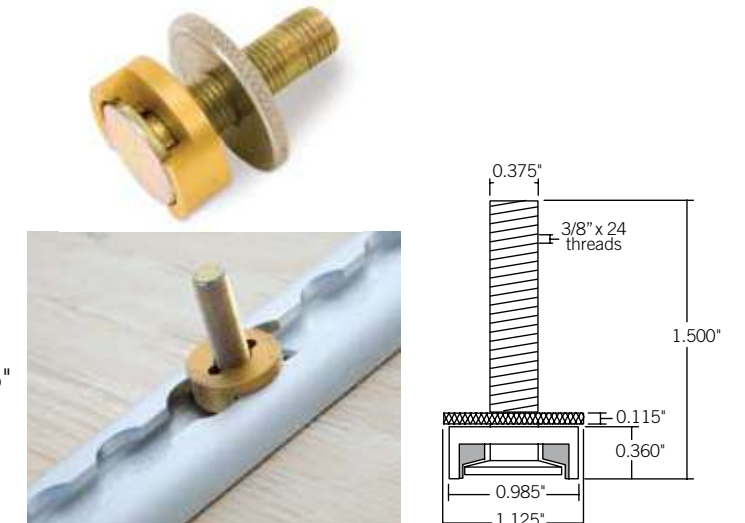

VERSATIE™ THREADED STUD

This fitting provides a hand-tightened, rattle-free track connection where quick release capability is not required. Ideal for adjustable shelving, work benches, tools, and equipment. Threaded Stud is rated for 5,000 lb in tension and 2,000 lb in shear.

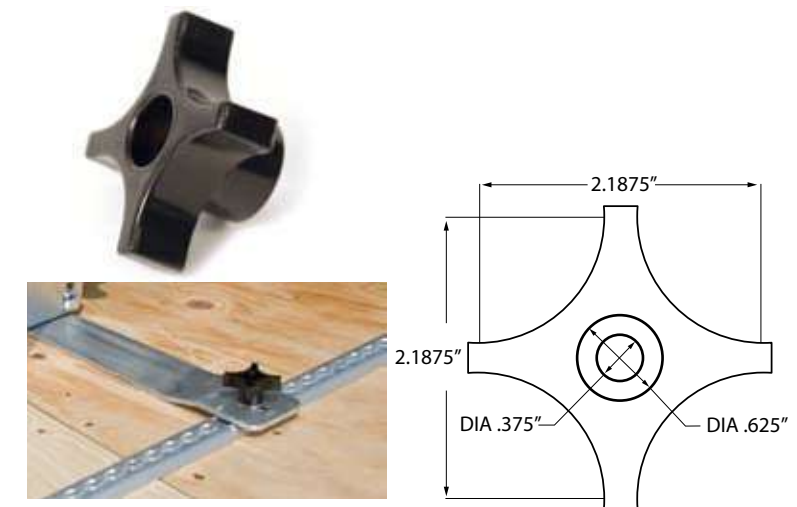

4 PRONG KNOB

This molded phenolic knob features a 3/8" x 24 threaded brass insert with a throughhole. This is just the ticket for quick release of brackets and components from Mac's Threaded Stud Fitting. Ideal for motorcycle wheel chock spreader bars!

* The four-prong knob is not weight rated and is used for convenience only.



TIE-DOWN SYSTEMS ADJUSTABLE

E-TRACK, A-TRACK & FITTINGS

Mac's E-Track and A-Track is used in a variety of applications: vehicle transportation, commercial, and industrial. Available in steel and aluminum with a wide variety of interchangeable hardware. E-Track fittings work in both E-Track and A-Track.



2-POSITION



4-POSITION

E TRACK MOUNTING PLATE

This quality stamped piece provides a 2 or 4 position attachment point for E or A-Track fittings. Zinc plated for corrosion resistance.



ROUND RING OR D-RING FITTING 3,000 LBS*

Series E or A-Track fitting with 2" Round Ring or D-Ring.



MAC'S ALUMINUM A-TRACK

Mac's Aluminum A-Track has a thickened edge for load beam support. Keep this in mind when mounting as the fittings only go one way.



E-TRACK BEAM SOCKET

Designed for use with standard commercial grade lumber. No load rating due to varying strength of lumber.



ROUND RING HEAVY-DUTY FITTING 6,000 LBS*

Series E or A heavy-duty fitting with 2" Round Ring. Easy access thumb release.



HORIZONTAL E-TRACK

Industry Standard Horizontal E-Track. Painted Black Steel.



ROPE TIE-OFF FITTING

Mac's 2" Rope Tie-Offs are designed to be used with light-duty ratchet or cam straps for interior van applications. Available in black only.

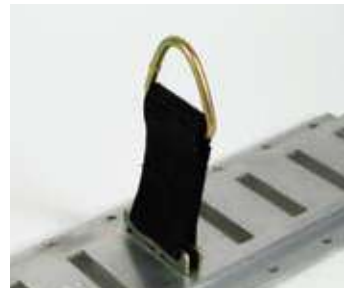

E-TRACK IDLER FITTING

Just the ticket for axle strap or wheel net applications where body clearance is critical. Works with either E or A-Track and features a roller to reduce strap wear.

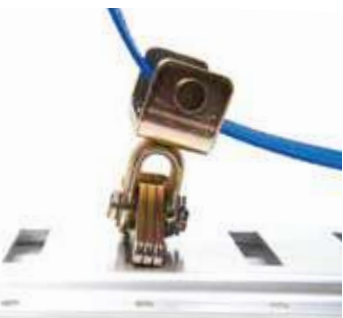

VERTICAL E-TRACK

Vertical E-Track is ideal for floor-mounted E-Track when hauling cars. Keeping the slots in line with the track allows the ring to conform to the angle of pull without bending the track—a common problem with Horizontal E-Track.

E-TRACK MOUNTING PLATE

2 Position	270004
4 Position	270005

E-TRACK BEAM SOCKET

320003

ROPE TIE-OFF FITTING

3,000 lb*	121001
-----------	--------

ROUND RING OR D-RING FITTING

Round Ring	3,000 lb*	320001
------------	-----------	--------

D-Ring	3,000 lb*	320002
--------	-----------	--------

ROUND RING HEAVY DUTY FITTING

6,000 lb*	320004
-----------	--------

E-TRACK IDLER FITTING

5,000 lb*	320005
-----------	--------

LENGTH	SHIPPING	NUMBER
--------	----------	--------

MAC'S ALUMINUM A-TRACK

2'	Ships	280003
5'	Ships	280002
8'	Ships	280004
10'	Truck Freight Only	280001

HORIZONTAL E-TRACK (PAINTED BLACK STEEL)

5'	Ships	280002
8'	Ships	280004

VERTICAL E-TRACK (PAINTED BLACK STEEL)

5'	Ships	270007
8'	Ships	270012



TIE-DOWN SYSTEMS FIXED POINT

VERSATIE™ PACK

SINGLE STUD TIE-DOWN RING



STAINLESS MACHINE SCREW



STAINLESS BACKING PLATE



ANODIZED ANCHOR PLATE



IMAGE IS NOT TO SCALE



Mac's VersaTie™ Anchor Plate Tie Downs are as slick as they are secure. Take the ring out, and you have a low profile, rounded anchor plate that won't get in the way of other loads. Slide the ring in and you are ready for a 1,000 lb.* load! Perfect for hauling motorcycles, carts and just about anything else that fits in the back of a truck! Our exclusive stainless steel backing plate is threaded for easy installation - drill two 1/4" holes and screw it together.



UNDER BED VIEW OF BACKING PLATE



VERSATIE™ THREADED STUD

4 PRONG KNOB

VERSATIE™ ANCHOR PLATE ASSEMBLY FOUR PACK

w/1" STAINLESS HARDWARE
520410

w/1.5" STAINLESS HARDWARE
520415

w/2.5" STAINLESS HARDWARE
520425

SINGLE STUD TIE DOWN RING

310001

ANODIZED ANCHOR PLATE FOR 1/4" FASTENERS

463002

STAINLESS BACKING PLATE FOR 1/4" FASTENERS

463003

MAC'S ANCHOR PLATE ASSEMBLY

w/1" STAINLESS HARDWARE
520010

w/1.5" STAINLESS HARDWARE
520015

w/2.5" STAINLESS HARDWARE
520025

VERSATIE™ THREADED STUD

5,000 lb* 310008

4 PRONG KNOB

472003

Assembly comes with all three components and stainless fasteners.

MACS TECH TIP

Tech Tip #1 - When installing your anchor plate packs, it's a good idea to put a dab of Loc-Tite™ on the threads for more security.

Tech Tip #2 - When installing, alternate between both screws to secure the backing plate evenly.



TIE-DOWN SYSTEMS FIXED POINT

CAPACITY NUMBER

SURFACE-MOUNTED D-RING

12,000 lb* 330001

BACKING PLATE FOR SURFACE-MOUNTED D-RING AND IDLER

472017

SURFACE-MOUNTED IDLER

10,000 lb* 330014

WELD-ON D-RING

12,000 lb* 330010
16,000 lb* 330011

LIGHT-DUTY SURFACE-MOUNT D-RING

900 lb* 330006

RECESSED D-RING

5,000 lb* 330002

BACKING PLATE FOR RECESSED D-RING

472005

RECESSED 360° SWIVEL D-RING

6,000 lb* 330003

Stainless Steel

6,000 lb* 330004

BACKING PLATE FOR SWIVEL D-RING

472006

BILLET 5,000 lb ALUMINUM D-RING

5,000 lb* 463004

BILLET 10,000 lb ALUMINUM D-RING

10,000 lb* 463006

BACKING PLATE FOR BILLET D-RINGS

5,000 lb* 463017

10,000 lb* 463018

DECK HARDWARE

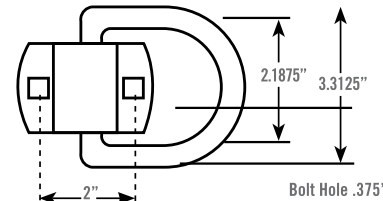

SURFACE-MOUNTED D-RING

This forged D-Ring is surface mounted for ease of installation. Zinc plated for corrosion resistance. Weld-on also available.



Hole Saw: 3.50"
Depth: .875"
Bolt Hole: .375"

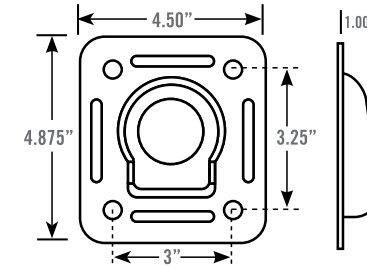

RECESSED D-RING

An industry standard, this 5,000 lb. capacity D-Ring lifts from the recess for easy use. Zinc plated for corrosion resistance.



Stainless Steel pictured

Hole Saw: 4.50"
Depth: 1.125"
Bolt Hole: .3125"

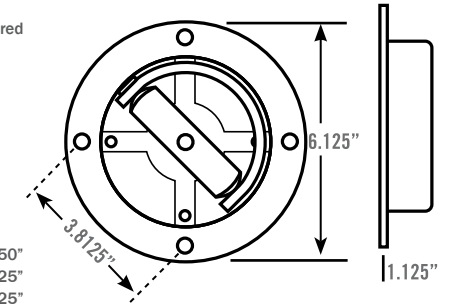

RECESSED 360° SWIVEL D-RING

Heavy duty 6,000 lb. capacity swivel D-Ring offers 360° rotation for maximum tie-down convenience. D-Ring lifts from recess for easy use. Zinc plated and stainless steel available.

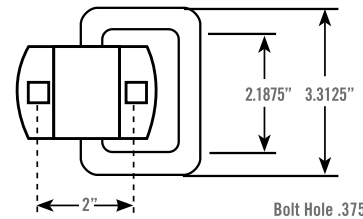

SURFACE-MOUNTED IDLER

This surface-mounted fitting is typically used as an idler fitting for a strap to pass through. Smooth surface helps protect webbing from abrasion. A perfect fit for 2" Straps. Ideal for Wheel Nets!

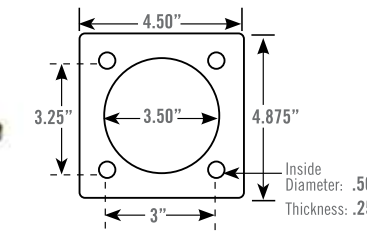

BACKING PLATE FOR RECESSED D-RING

Cut from 1/4" thick steel. This piece is a must to achieve the full capacity of the D-Ring.

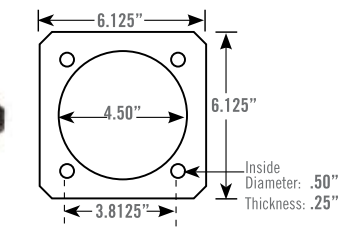

BACKING PLATE FOR SWIVEL D-RING

Cut from 1/4" thick steel. This piece is a must to achieve the full capacity of the D-Ring.

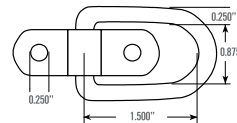

LIGHT-DUTY SURFACE-MOUNT D-RING

These handy surface-mounted D-rings work great for individual tie-down locations. 1" mounting hardware included. Sold in pairs with mounting hardware included.

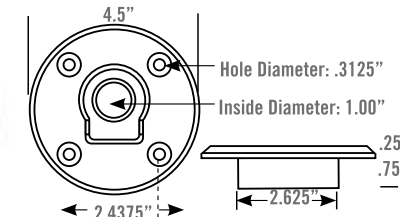

BILLET 5,000 LB ALUMINUM D-RING

Recessed D-Ring that is fully CNC machined from billet aluminum. Aluminum backing plate available.

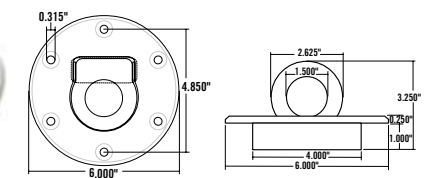

BILLET 10,000 LB ALUMINUM D-RING

Recessed D-Ring that is fully CNC machined from billet aluminum. Aluminum backing plate available.



HEAVY DUTY

BELOW IS A CLOSEUP OF THE WHEEL NET SYSTEM FORD COMMISSIONED US TO MAKE TO HOLD AN OCCUPIED EXPLORER ON AN ARTICULATED DRIVING SIMULATOR. JUST ANOTHER EXAMPLE OF EXACTLY HOW MUCH ABUSE OUR TIE-DOWNS ENDURE.



WE SIMPLY COULD NOT COMPROMISE ANYTHING

"When Ford Motor Company showcased the "First in the World" indoor Dragstrip Dyno Display in their booth at the SEMA Show, Mac's Tie Downs were their only choice for safety and security. We simply could not compromise anything with an indoor display that featured a Mustang blasting down a simulated 1/4 mile dragstrip on a chasis dyno with hundreds of people standing in front of the car. A failure of a critical safety system would be catastrophic – that is why we trust Mac's Tie Downs to make sure that nothing is left to chance. Mac's quality and commitment to safety is unmatched in the industry today!"

BOB ADAMS



Global Auto Shows and Events
Ford Motor Company (retired)



HEAVY DUTY

TIE-DOWNS

PRO PACK INCLUDES

- (4) 10K* Ratchet Straps
- (4) 10K* Axle Straps
- (4) Protective Fleece Sleeves
- (4) Strap Wraps
- (1) Large Padded Duffle Bag



REMOVABLE/
MACHINE-WASHABLE
PROTECTIVE FLEECE

THROUGH-THE-WHEEL

REMOVABLE
WASHABLE PAD

STRAP WRAPS
INCLUDED



PRO PACK

You don't have to be a professional to appreciate all the benefits of our newest tie down package. You just have to want the ultimate protection available to transport your vehicle. The 40" through-the-wheel Pro Pack has four of our best selling ratchet straps and four axle straps that have been made 40" long to accommodate today's larger wheel and tire combinations. To that we add 32" of padded fleece sleeve protectors so the only surface touching your nice wheels is a 3/8" foam pad...covered in soft black fleece. This is the most protective strap package on the market.



STRAP COLORS

PRO PACK

LENGTH	BLACK	BLUE	RED	YELLOW
w/ 24" Axle Straps & Twisted Snap Hook				
6'	511606	512606	513606	514606
8'	511608	512608	513608	514608
w/ 40" Through-the-Wheel Straps & Twisted Snap Hook				
6'	511646	512646	513646	514646
8'	511648	512648	513648	514648



Twisted Snap Hook

w/ 24" Axle Straps & Direct Hook Ratchet				
6'	511616	512616	513616	514616
8'	511618	512618	513618	514618

w/ 40" Through-the-Wheel Straps and Direct Hook Ratchet				
6'	511656	512656	513656	514656
8'	511658	512658	513658	514658



Direct Hook



PHOTO COURTESY OF MILLER INDUSTRIES



HEAVY DUTY

TIE-DOWNS

ULTRA PACK

Mac's best-selling tie-down package is back, and it's better than ever. The Ultra Pack features separate axle straps and ratchet straps. The hardware on a separate axle strap is shaped to allow for tight clearance applications. Our full-length sleeve is designed to stay in place (unlike competitive sliding products) and is made from the thickest material available. All straps in this pack have more than twice the number of stitches than most competitors' straps. Four each ratchet straps and axle straps are included in the signature Mac's black duffel bag for a complete tie-down solution.

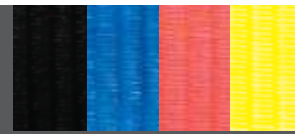

STRAP COLORS

ULTRA PACK

LENGTH	BLACK	BLUE	RED	YELLOW
--------	-------	------	-----	--------

w/ Twisted Snap Hook				
6'	511206	512206	513206	514206
8'	511208	512208	513208	514208



Twisted Snap Hook

w/ Direct Hook Ratchet				
6'	511216	512216	513216	514216
8'	511218	512218	513218	514218



Direct Hook

w/ Chain Extension				
6'	511226	512226	513226	514226
8'	511228	512228	513228	514228



Chain Extension



CONNECTED TO AXLE STRAP



TWISTED SNAP HOOK



DIRECT HOOK RATCHET

ULTRA PACK INCLUDES

- (4) 10K* Ratchet Straps
- (4) 10K* 24" Axle Straps
- (4) Strap Wraps
- (1) Mac's Black Duffel Bag





HEAVY DUTY

TIE-DOWNS



MINI J-HOOK



T-HOOK



R-HOOK



TRANSIT CLUSTER



8" & 15" J-HOOKS



- TOW PACK INCLUDES**
- (4) 8' 10K* Ratchet Straps w/ choice of tow hardware sewn on
 - (4) Strap Wraps
 - (1) Mac's Black Duffle Bag



TOW PACK

If you want to use your factory shipping hook locations instead of a wheel or axle style solution, Mac's has you covered with our Tow Pack. Whether your vehicle was designed for J-hooks, T-hooks or R-hooks, we strike the perfect balance between a factory solution and ease of a strap package.



TOW PACK (length: 8')

HARDWARE	BLACK	BLUE	RED	YELLOW
	w/ Twisted Snap Hook			
Mini J	511501	512501	513501	514501
T-Hook	511502	512502	513502	514502
R-Hook	511503	512503	513503	514503
Transit	511504	512504	513504	514504



Twisted Snap Hook

	w/ Direct Hook Ratchet			
Mini J	511511	512511	513511	514511
T-Hook	511512	512512	513512	514512
R-Hook	511513	512513	513513	514513
Transit	511514	512514	513514	514514

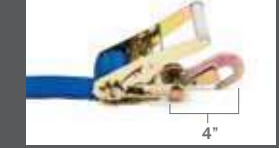

Direct Hook

	w/ Chain Extension			
Mini J	511521	512521	513521	514521
T-Hook	511522	512522	513522	514522
R-Hook	511523	512523	513523	514523
Transit	511524	512524	513524	514524



Chain Extension

TOW HOOKS (Zinc Plated)		
Transit Cluster		340001
Mini J		340002
T-Hook		340003
R-Hook		340004
8" J-Hook		340005
15" J Hook		340006



PHOTO COURTESY OF MILLER INDUSTRIES



HEAVY DUTY

TIE-DOWNS

SUPER PACK INCLUDES

- (4) 10K* Combination Axle Straps
- (4) Strap Wraps
- (1) Mac's Black Duffle Bag



SUPER PACK

Mac's Super Pack is ideal for more open applications where clearance is not an issue. Combining the axle straps and ratchet straps keeps costs down while maintaining the same high quality the industry has come to expect from Mac's. We've twisted the hooks on our straps to keep them aligned for maximum strength and ease of use. The pack comes in one of Mac's popular black bags for neat portability.



STRAP COLORS

SUPER PACK

LENGTH	BLACK	BLUE	RED	YELLOW
w/ Twisted Snap Hook				
6'	511106	512106	513106	514106
8'	511108	512108	513108	514108
w/ Direct Hook Ratchet				
6'	511116	512116	513116	514116
8'	511118	512118	513118	514118
w/ Chain Extension				
6'	511126	512126	513126	514126
8'	511128	512128	513128	514128



Twisted Snap Hook

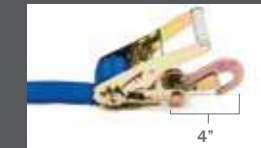

Direct Hook



Chain Extension



HEAVY DUTY

STRAPS

AXLE STRAPS

COMPARE MAC'S AXLE STRAP WITH A LEADING COMPETITOR'S STRAP.

Design, materials, and workmanship are all the highest quality on the Mac's strap. When you put ours next to theirs, we think the differences are obvious. Mac's 10,000 lb.* rated Axle Strap uses 12,000 lb.* webbing, and thick, full-length sleeve protector. Mac's charges only a little more for our superior quality straps. We think it's worth the difference, and so will you.

MAC'S PROTECTIVE SLEEVE IS TWICE AS THICK WITH FULL-LENGTH PROTECTION.



THE COMPETITOR'S PROTECTIVE SLEEVE IS SHORT AND FLIMSY AND CAN SLIDE OUT OF PLACE.



SUPERIOR STITCHING:

Here we have pulled back the protective sleeve so you can take a close look at our sewing compared to theirs.

8" WITH OVER 200 STITCHES

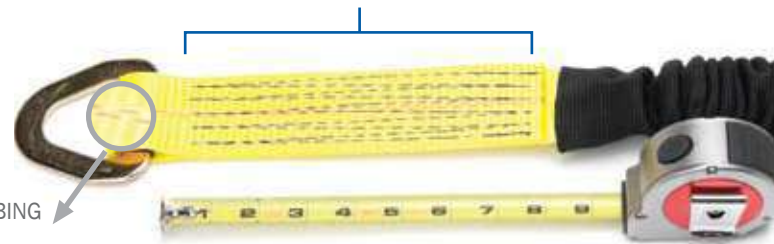

MAC'S
12,000 LB.* RATED WEBBING
(SEE RED LINE)

3" WITH LESS THAN 100 STITCHES



THEIRS
COARSE WEBBING WITH
NO STRENGTH INDICATOR

MEDIUM DUFFLE BAG

A Heavy-Duty 18" x 8" x 8" bag designed to store your straps and hardware. Designed to hold (4) 2" ratchet assemblies, plus a little more.



STRAP COLORS

LENGTH	BLACK	BLUE	RED	YELLOW
--------	-------	------	-----	--------

AXLE STRAPS

24"	121724	122724	123724	124724
36"	121736	122736	123736	124736
40"	121740	122740	123740	124740

BRIDLE

36" legs	121936	122936	123936	124936
----------	--------	--------	--------	--------

COMBO BRIDLE

	Combination Axle Strap style			
48" legs	121937	122937	123937	124937

MEDIUM DUFFLE BAG

610002

LARGE PADDED DUFFLE BAG

610004

LARGE PADDED DUFFLE BAG

We needed a bigger bag for our bigger packs, so here it is! Padded sides keep the rectangular shape. Sized exactly right for carry on luggage! 22" x 9" x 9"



BRIDLE & COMBO BRIDLE

Mac's Bridle is for winching your car into the trailer. NOT to be used as a tie down.



BRIDLE

COMBO BRIDLE





HEAVY DUTY

STRAPS

2" STRAPS



STRAP COLORS

LENGTH	BLACK	BLUE	RED	YELLOW
--------	-------	------	-----	--------

RATCHET STRAPS

w/ Twisted Snap Hooks				
6'	121006	122006	123006	124006
8'	121008	122008	123008	124008
10'	121010	122010	123010	124010

w/ Flat Snap Hooks				
6'	121106	122106	123106	124106
8'	121108	122108	123108	124108
10'	121110	122110	123110	124110

w/ Wire Hooks				
12'	121212	122212	123212	124212
16'	121216	122216	123216	124216
27'	121227	122227	123227	124227
30'	121230	122230	123230	124230

w/ Flat Hooks				
12'	121312	122312	123312	124312
16'	121316	122316	123316	124316
27'	121327	122327	123327	124327
30'	121330	122330	123330	124330

COMBINATION AXLE STRAP

6'	121406	122406	123406	124406
8'	121408	122408	123408	124408
10'	121410	122410	123410	124410

ADJUSTABLE TIE-BACK STRAP

48"	121548	122548	123548	124548
-----	--------	--------	--------	--------

FIXED LENGTH TIE-BACK STRAP

24"	121624	122624	123624	124624
36"	121636	122636	123636	124636
48"	121648	122648	123648	124648

PROTECTIVE FLEECE SLEEVES

20"	416002	416007
32"	416006	

DYNO SLEEVES

5"x36"	999305	421020
--------	--------	--------

STRAP WRAP

DIRECT HOOK KIT



DIRECT HOOK KIT

Converts a 2" wide ratchet handle to a shorter one with this bolt on kit!



DYNO SLEEVE

Mac's Dyno Heat Shield protects up to 600 degrees* - because we all know what hot pipes do to straps!



STRAP WRAP

Mac's strap wrap is more than just hook and loop fastener. It's webbing with a square ring and hook and loop fastener sewn on along with an embossed rubber pull handle. This thing is meant to last. Great for keeping your straps tidy. Also works well for garden hoses, air line, etc.



PROTECTIVE FLEECE

The ultimate protection for fine finishes. This sleeve features an integral piece of foam padding and a hook and loop fastener construction. Attach over 2" webbing. Ideal for use on Axle Straps or Combination Axle Straps.

COMBINATION AXLE STRAP

Our most popular automotive tie down. This 10,000 lb.* unit combines an axle strap and a ratchet strap into one assembly. Features include: wide-handle ratchet, adjustable loop diameter, and full-sleeve protector.



ADJUSTABLE TIE-BACK STRAP

This 10,000 lb.* strap offers approximately 12" of adjustment by simply sliding the delta ring to the desired position. Typically used in pairs on one end of the vehicle with ratchet straps used for tension on the other end.



FIXED LENGTH TIE-BACK STRAPS

Simple, strong, and convenient. Ideal for applications that demand strength without adjustability.



RATCHET STRAPS

WITH TWISTED SNAP HOOKS

This 10,000 lb.* rated all-purpose strap features twisted-snap hooks on both ends with a wide-handle ratchet.



WITH FLAT SNAP HOOKS

This 10,000 lb.* rated all-purpose strap features flat snap hooks on both ends with a wide-handle ratchet.



WITH WIRE HOOKS

This 10,000 lb.* rated all-purpose strap features wire hooks on both ends with a wide-handle ratchet.



WITH FLAT HOOKS

This 10,000 lb.* rated all-purpose strap features flat hooks on both ends with a wide-handle ratchet.



*These are the most popular sizes, but we have thousands of configurations available.



HEAVY DUTY

STRAPS

TREE TRUNK PROTECTOR

Wrap a Tree Trunk Protector around that woody friend before yanking on it with a few thousand pounds. Protect the environment while saving your rig.



No sweatshops here; this photo is only a mile away from Mac's factory where we all enjoy what we call "the good life." That little city in the background is Sandpoint, Idaho, named America's Most Beautiful Small Town 2011 by USA Today and Rand McNally.



SIZE	BREAKING STRENGTH	NUMBER
------	-------------------	--------

RECOVERY STRAPS

2" X 20'	17,000 lb*	128020
2" X 30'	17,000 lb*	128030
3" X 20'	27,000 lb*	134020
3" X 30'	27,000 lb*	134030
4" X 20'	37,000 lb*	140020
4" X 30'	37,000 lb*	140030
6" X 20'	57,000 lb*	160020
6" X 30'	57,000 lb*	160030

TREE TRUNK PROTECTOR

3" X 8'	27,000 lb*	130108
4" X 8'	37,000 lb*	140108

RECOVERY STRAPS

Our Recovery Straps feature premium-quality nylon webbing, super-strong stitching, and lined eyes for maximum durability.





HEAVY DUTY

STRAPS

LOGISTIC RATCHET STRAP

- 12' (YELLOW ONLY) 129012
- 16' (GRAY ONLY) 129016
- 20' (BLUE ONLY) 129020

LOGISTIC CAM STRAP

- 12' (YELLOW ONLY) 129112
- 16' (GRAY ONLY) 129116
- 20' (BLUE ONLY) 129120

Mac's Aluminum A-Track

Horizontal E-Track



LOGISTIC STRAPS

Mac's logistic straps are built here in the USA to exacting standards. We offer the best quality available in industry standard lengths, configurations, and color codes. All straps shown here have a safe working load limit of 1,000 lbs.* Will work with E-Track and A-Track.

LOGISTIC CAM STRAP

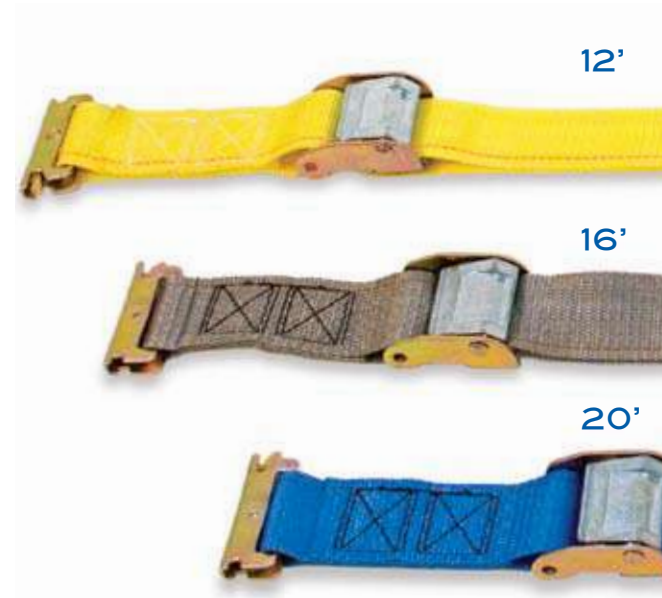

LOGISTIC RATCHET STRAP



2" CUSTOM STRAPS

FIXED END HARDWARE



2" STRAP

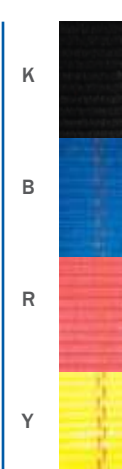

TENSIONER



RUNNING END HARDWARE

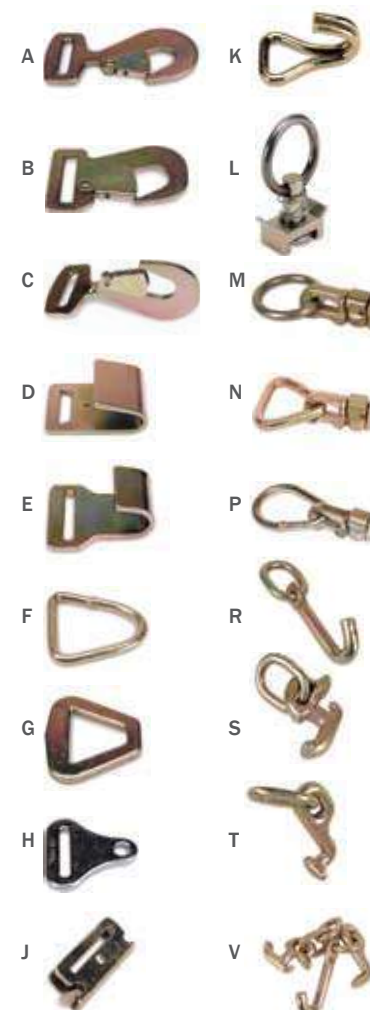

CUSTOM ORDER ID CODE

FIXED / RUNNING END HARDWARE:

- A Flat Snap Hook - 10k*
- B Flat Snap Hook - 5k*
- C Twisted Snap Hook - 10k*
- D Flat Hook - 10k*
- E Narrow Flat Hook - 5k*
- F D-Ring - 5k*
- G Delta Ring - 10k*
- H Bolt Fitting
- J E-Clip
- K Wire Hook - 10k*
- L VersaTie™ Single Stud Ring
- M VersaTie™ Double Stud Ring
- N VersaTie™ Idler
- P VersaTie™ Double Stud Pear Ring
- R J-Hook - 16k*
- S R-Hook - 16k*
- T T-Hook - 16k*
- V Transit Cluster - 16k*

STRAP LENGTH:

- 72", 96", 120", 144"
- Custom

STRAP COLOR:

- K Black
- B Blue
- R Red
- Y Yellow

TENSIONER:

- M Wide Handle - 10k*
- N Short Narrow Handle - 10k*
- P Stainless Wide Handle - 10k*
- Q Mini Ratchet - 5k*
- R Direct Hook Ratchet - 10k*
- S Cam Tensioner - 1.2 k*

HOW TO ORDER CUSTOM 2" TIE-DOWN STRAPS

To order a 2" custom strap, choose the necessary components of your desired strap, identify the corresponding identification code and list them in the following sequence:

FIXED END HARDWARE



A

COLOR & LENGTH



R

TENSIONER TYPE



M

RUNNING END HARDWARE



A

= 2-AR72MA

DETERMINES ASSEMBLY LENGTH

For example: To order a red 2" x 72" ratchet strap with a flat snap hook on the fixed end, and a flat snap hook on the running end (as shown above). The order number would be: 2-AR72MA

Note: Other hardware and webbing is available.

*In all cases, straps are measured.



WHEEL NETS



**TO BE THE BEST, WE
RELY ON THE BEST...**

Our motto at CytoSport is "Driven by Science – Inspired by Performance" and nothing out-performs Mac's Tie Downs . When it comes to getting our Muscle Milk Porsche RS Spyder to the track, whether it's across the country or around the world, Team CytoSport trusts nothing less than Mac's to ensure our vehicle arrives in prime racing condition.

Quality products, exceptional service and peace of mind. Mac's Tie Downs wins in every class.

GREG PICKETT

MUSCLE MILK Founder CytoSport™ Inc. and
American Racing Legend



WHEEL NETS

WHEEL NETS

WHEEL NETS METHODS

Why would you choose one system over another? The fixed point with ratchet works excellently, when tying down cars of identical wheelbases, parked in exactly the same location on the trailer each time.

The fixed point with wrench operated lashing winch is useful for tight quarters where a standard ratchet might be problematic.

E-Track has been in use for over 50 years, and the broad install base means parts are plentiful. Our idlers are the lowest in the industry; clearing air dams and splitters by a larger margin.

VersaTie™ has twice as many locations to connect to and has the lowest adjustable idler available. For ultra-low profile vehicles, there is no substitute.



STRAP COLORS

BLACK BLUE RED YELLOW

FIXED POINT CUSTOM WHEEL NET KIT

w/ Ratchet
511360 512360 513360 514360

w/ Lashing Winch
511361 512361 513361 514361

E-TRACK CUSTOM WHEEL NET KIT

w/ Ratchet
511362 512362 513362 514362

VERSATIE™ CUSTOM WHEEL NET KIT

w/ Ratchet
511363 512363 513363 514363

Purchase (2) kits and we'll throw in the Strap Wraps and Large Black Duffie to keep everything perfect!



FIXED POINT CUSTOM WHEEL NET KIT WITH RATCHET INCLUDES

- (2) Wheel Nets with Direct Hook Ratchet
- (4) D-Rings with Backing Plates
- (2) Idlers with Backing Plates



FIXED POINT CUSTOM WHEEL NET KIT WITH LASHING WINCH INCLUDES

- (2) Wheel Nets with Lashing Winches
- (4) D-Rings with Backing Plates
- (2) Idlers with Backing Plates



E-TRACK CUSTOM WHEEL NET KIT WITH RATCHET INCLUDES

- (2) Wheel Nets with E-Clips
- (2) E-Track Idlers
- (2) 8' Lengths of E-Track



VERSATIE™ CUSTOM WHEEL NET KIT WITH RATCHET INCLUDES

- (2) Wheel Nets with VersaTie™ Double-Stud Rings
- (2) VersaTie™ Idlers
- (2) 8' Lengths of VersaTie™ Track



WHEEL NETS

WHEEL NETS



STRAP COLORS

SIZE	BLACK	BLUE	RED	YELLOW
------	-------	------	-----	--------

NET ONLY (no ratchet)

Small	121801	122801	123801	124801
Medium	121803	122803	123803	124803
Large	121805	122805	123805	124805

WHEEL NET ASSEMBLY (includes ratchet)

This solution requires tie down rings just in front and behind each wheel. Direct hook ratchet assembly included.

Small	511301	512301	513301	514301
Medium	511303	512303	513303	514303
Large	511305	512305	513305	514305

TIRE BLOCK STRAP

	w/ Twisted Snap Hook Both Ends			
10'	121810	122810	123810	124810
	w/ E-clip Both Ends			
10'	121910	122910	123910	124910

INDIVIDUAL TIRE BLOCK

421018

Please Note:
VersaTie™ Track and E-Track hardware can be sewn directly to the net for an additional charge!

STANDARD WHEEL NETS



MACS TECH TIP

Note proper angle of ends. Wheels should be tied down near the centerline of the tire, slightly ahead of the front and slightly behind the rear most point.

CORRECT



TOO CLOSE



TOO FAR



TIRE BLOCK STRAP



TWISTED SNAP HOOK



E-CLIP



TIRE BLOCK

For those who need a 'one size fits all' tire tie down, Mac's offers the Tire Block. A set of three Tire Blocks threaded onto a standard 2" strap keep the strap from migrating off the tire with the rubber 'teeth' that bite into the tire's grooves. When used with an idler and track system, the tire block makes for a very flexible tie-down system. Ideal for commercial carriers.



WHEEL NETS

WHEEL NETS



ULTRA LOW CLEARANCE



EXTRA HEIGHT



SPREADER BAR STYLE



SHOW CARS



CUSTOM WHEEL NETS

Mac's custom wheel nets are for those tires that are bigger, taller, wider, or just more unusual than a normal street tire.

Step #2



Step #3



Step #4





WHEEL NETS

WHEEL NETS

DRAG PACK INCLUDES

- (2) Rear Dragster Nets
- (2) Front Dragster Nets
- (4) Anchor Plate Assemblies
- (4) Recessed D-Rings
- (4) Backing Plates for Recessed
- (1) Large Padded Duffle Bag



WHEEL CRADLE

Mac's rubber wheel cradles keep everything in the same place, every time. They do an excellent job preventing wheel movement and augmenting tie-down straps.

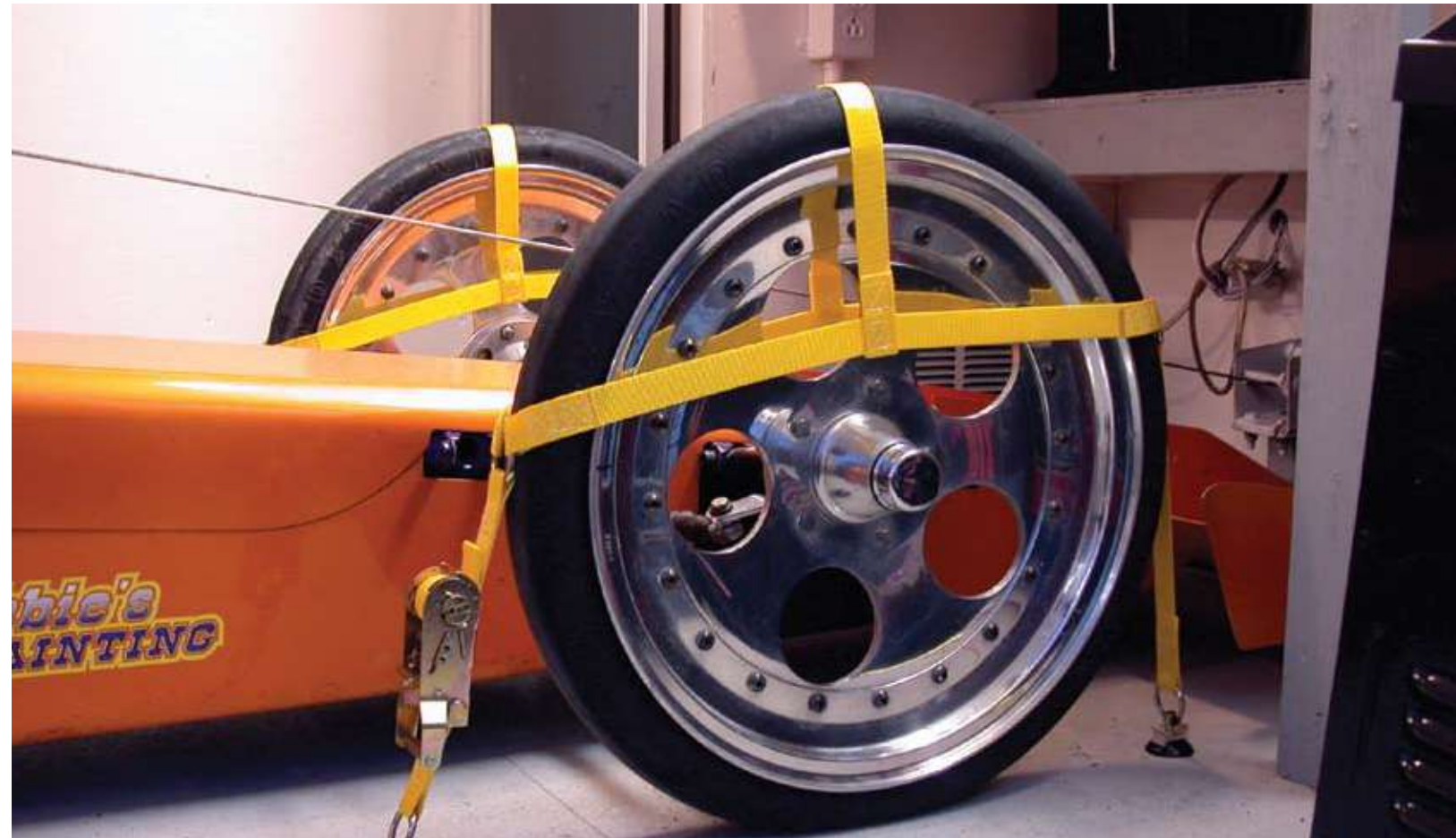

MACS TECH TIP

IMPORTANT! Before tying your dragster down, inflate the rear tires to a level that will allow the wheel nets to do their work! Lack of pressure in the rear tires can negate the effect of the net.

DRAG PACK

Mac's Drag Pack is the ideal solution for getting your dragster from your garage to the track and back again safely. The rear nets use a CNC-machined billet aluminum bar to spread the stress over the whole tire. Using a single strap on an oversized, soft tire can damage the tire in transit. All necessary D-Rings and connectors are included.



STRAP COLORS

BLACK	BLUE	RED	YELLOW
-------	------	-----	--------

DRAG PACK

Everything you need to tie down one dragster, rear net fits 13+” wide to 34” tall

511390	512390	513390	514390
--------	--------	--------	--------

In nostalgia size, fits 10+” wide to 34” tall

511392	512392	513392	514392
--------	--------	--------	--------

REAR NET DRAG PACK

w/D-Rings and Backing Plates, fits 13+” wide to 34” tall

121850	122850	123850	124850
--------	--------	--------	--------

In nostalgia size, fits 10+” wide to 34” tall

121852	122852	123852	124852
--------	--------	--------	--------

REAR NET ASSEMBLY

Pair, no D-rings, fits 13+” wide to 34” tall

121834	122834	123834	123834
--------	--------	--------	--------

In Nostalgia Size

121837	122837	123837	123837
--------	--------	--------	--------

FRONT NET DRAG PACK

Pair w/ VersaTie™ ends sewn on, VersaTie™ anchor plate assembly included.

111502	112502	113502	114502
--------	--------	--------	--------

FRONT NETS

Pair w/ Flat Snap Hooks, no mounting hardware

111501	112501	113501	114501
--------	--------	--------	--------

WHEEL CRADLE

Dragster Front
700005

L-Shaped Chock
700004

Anchor Plate Assembly



Recessed D-Ring



Backing Plate





POWER SPORTS



LEADING CLIENTS ON HIGH-THRILL ADVENTURES, NOTHING CAN BE LEFT TO CHANCE...

Whether it is motocross or the Baja 1000, leading motorcycle adventure tours in Baja or instructing U.S. Military personnel on how to drive, the adventure doesn't begin until I have both wheels on the ground. That is why I rely on Mac's Tie Downs to ensure that my bike arrives safely and in perfect driving condition. Nothing compares to the thrill of tearing through hundreds of miles of desert terrain, and nothing compares to Mac's Tie Downs for reliability, quality and peace of mind.

CHRIS HAINES



Hall-of-Famer, 13 time Baja 1000 winner,
and owner of Chris Haines Motorcycle
Adventure Company



POWER SPORTS SUPER CLAMP

SUPERCLAMP FRONT CLAMP

740301

SUPERCLAMP BACK CLAMP

740302

EXTRA DECK HOOKS

Threaded Style

740303

EXTRA DECK HOOKS

T-Slot

740312

SPYDER TIE-DOWN COMPLETE SYSTEM

740304

ATV/UTV COMPLETE SYSTEM

740305

ATV/UTV FRONT CHOCKS ONLY

740306

SUPERGLIDES

w/Screws. Includes (8) 30" x 8.25" pieces for 20' total.

740307

SUPERGLIDES TRIM KIT

40'

740311

MAC'S SUPERCLAMP

Mac's SuperClamp line is quite simply the best composite construction specialty tie-down available. There is no better way to tie down a snowmobile, Spyder, ATV or UTV.

FRONT CLAMP



REAR CLAMP



ATV/UTV FRONT CHOCKS



SPYDER STRAPS



ATV/UTV REAR CLAMPS



SUPERGLIDES



SUPERGLIDES TRIM KIT



SUPERGLIDES

SuperGlides give you great traction in the trailer while making a sturdy surface for your sled's skis to glide across. The durable composite construction will last much longer than a rubber or wood floor. Available with or without the aluminum trim.





POWER SPORTS MOTORCYCLE



ARROWHEAD END CAPS



FLEECE SLEEVE & SOFT LOOP



HEAVY DUTY VERSATIE™ FITTINGS



ULTIMATE BIKE PACK

This is how we do it at Mac's. Our patented VersaTie™ track, Mac's quality straps with everything you need for a full installation. This is the strongest, most flexible and straight-up coolest complete bike tie-down system in existence. Want to bring a friend? Buy the Twin Kit and get a matching set utilizing the same center track. Everything you need for a two-place trailer.

ULTIMATE PACKS INCLUDE

BIKE PACK	TWIN PACK	
(4)	(8)	1" x 6' Ratchet Straps
(4)	(8)	18" Soft Loop Extensions
(4)	(8)	Protective Fleece Sleeves
(4)	(8)	Mac's Strap Bands
(4)	(6)	6' Lengths of VersaTie™ Track (Profile 3)
(4)	(6)	VersaTie™ Billet Aluminum Arrowheads
(1)	(2)	Lock Chock
(2)	(4)	VersaTie™ Threaded Stud Fittings
(2)	(4)	VersaTie™ Phenolic Four Prong Knobs
(1)	(2)	VersaTie™ 40" Wheel Chock Spreader Bar
(4)	(8)	VersaTie™ Double Stud Pear Shaped Rings
(1)	(1)	Medium Black Duffle Bag

Kits include all necessary all stainless 1 1/2" hardware!



STRAP COLORS

ULTIMATE BIKE PACK (Everything you need for a One-Bike Trailer)

BLACK	BLUE	RED	YELLOW	GREEN	PURPLE	SILVER
510081	510082	510083	510084	510085	510086	510087

ULTIMATE TWIN PACK (Everything you need for a Two-Bike Trailer)

510091	510092	510093	510094	510095	510096	510097
--------	--------	--------	--------	--------	--------	--------



POWER SPORTS MOTORCYCLE



STRAP COLORS

16" PROTECTIVE FLEECE

416005

STRAP BANDS

416008

SMALL BLACK DUFFLE BAG

610001

VERSATIE™ PACK

520410

MOTORCYCLE PACK

BLACK	BLUE	RED	YELLOW	GREEN	PURPLE	SILVER
510001	510002	510003	510004	510005	510006	510007

STRAP RINGS

330009

HANDLEBAR HARNESS WITH CUP

737016

HANDLEBAR HARNESS

737015

MOTORCYCLE PACK

Mac's founder, Colin McLemore, has been into bikes since way back. Harleys, Hondas, BMWs – they all have a special place in his heart (and his garage!) That's just one of the reasons we're so adamant about the quality of our motorcycle packages and products. Because there's a right way to tie down your bike, and at the end of the day, all that counts is that it's in the same pristine condition as when it left your garage. Hey, everyone here at Mac's uses them, and we wouldn't steer you wrong.



16" PROTECTIVE FLEECE

The ultimate protection for fine finishes. Full-length, thick-padded fleece sleeve.

MOTORCYCLE PACK INCLUDES

- (4) 1" x 6' Ratchet Straps
- (4) 1" x 18" Soft Loops
- (4) Strap Bands
- (1) Small Black Duffle Bag



STRAP BANDS

A great method for keeping your straps tidy.



SMALL BLACK DUFFLE BAG

A heavy-duty bag designed to store your straps and hardware. Plenty of room for storage of tie downs for one bike.



VERSATIE™ PACK

These anchor plates and rings offer a low profile, quick-release, four-point tie-down system with a safe Working Load of 1,000 lbs.* Set of four.



STRAP RINGS

Transform virtually any 8mm fastener into a tie-down point on your bike or ATV! Stainless Steel, Made in the USA!



HANDLEBAR HARNESS WITH CUP

This Canyon Dancer™ design adds a hard rubber 'cup' to prevent the harness from migrating inward and damaging grips and controls.



HANDLEBAR HARNESS

Time-proven Canyon Dancer™ design that grabs the handgrips to provide a forward tie-down point in limited clearance applications.





LOCK CHOCK

Made of 3/16" carbon steel plate and 5/8" solid thick-walled tubing, the Lock Chock is made to last. A generous chrome plate finish makes it shine – just like your ride. An optional Narrow Tire Kit is available for tires 3.5" wide and narrower.

THE SAFEST EASIEST WAY FOR ONE PERSON TO LOAD A BIKE!

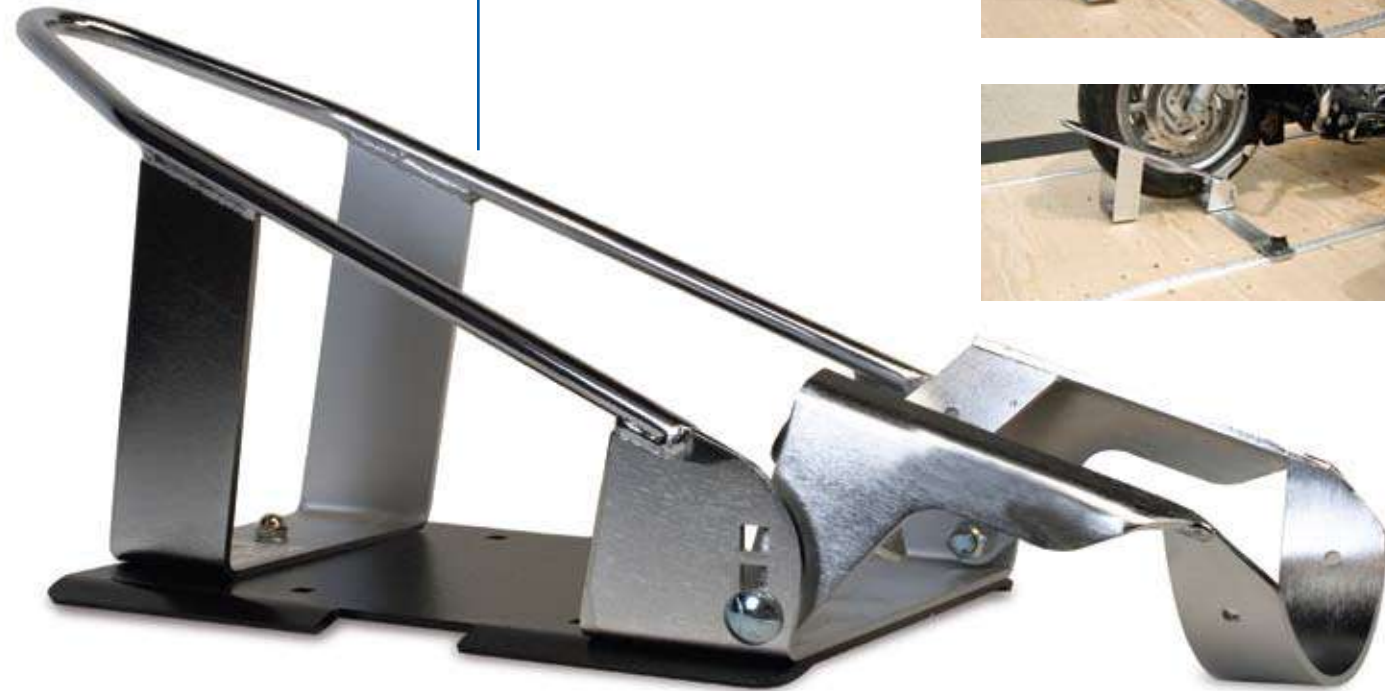

NARROW TIRE KIT



MAC'S TECH TIP

Using the Lock Chock is a one minute, one person job. Simply roll the front wheel of your bike in and let the self-locking chock do the work. The rear cradle uses simple, gentle leverage to firmly lock the bike - it does not flip or snap into position. To release, simply pull backward with about the same force as pulling off a center stand.

MAC'S WEDGE™

This chock is truly universal. Constructed from mandrel bent steel tubing, this chock will handle virtually all motorcycle tires. Due to its unique "wedge shaped" design, the narrower the tire, the further into the chock it sits. The bike sits on top of a base plate when secured for ultimate stability. In addition, the Mac's Wedge™ can be integrated with our VersaTie™ track by the use of a spreader bar allowing the chock to be adjusted front to rear in the trailer in 1" increments. Our innovative mounting system prevents Mac's Wedge™ from popping out of place, eliminating the biggest problem with other wheel chocks.

WEDGE-SHAPED DESIGN ESTABLISHES A UNIVERSAL FIT



THE LAST MOTORCYCLE WHEEL CHOCK YOU'LL EVER BUY

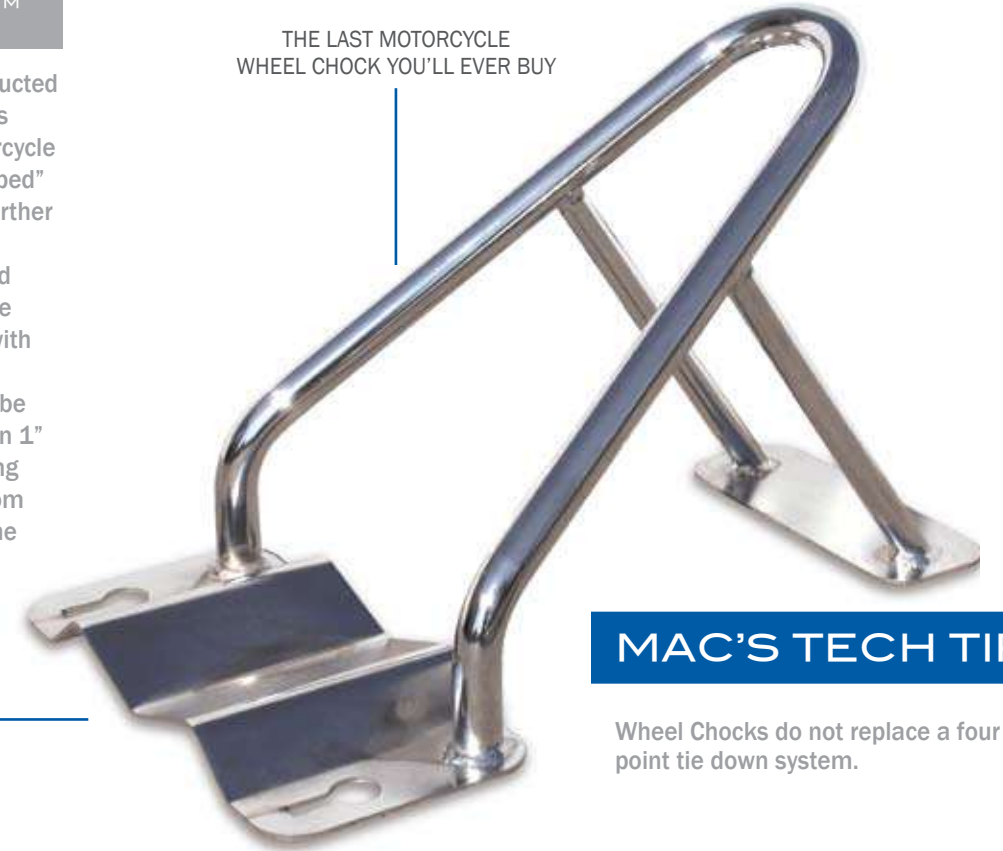

MAC'S TECH TIP

Wheel Chocks do not replace a four point tie down system.



40" SPREADER BAR

LOCK CHOCK

472012

LOCK CHOCK NARROW TIRE KIT

485001

MAC'S WEDGE™

472013

40" SPREADER BAR

635000



POWER SPORTS



ATV PACK



ANCHOR PLATE ASSEMBLY



STAINLESS, THREADED BACKING PLATE FOR ANCHOR PLATE ASSEMBLY



ATV PACK INCLUDES

- (2) Rear Nets
- (2) Front Nets
- (4) Strap Bands
- (1) Medium Duffle Bag

Anchor plate version comes with all mounting hardware.

Mac's ATV Wheel Net Pack is the ideal way to transport any ATV. We've talked with so many customers who are compressing their suspensions with conventional ratchet straps, and they seem to have one of two problems:

EITHER

1) Connecting to the chassis and compressing the suspension so it can't compress further is hard on suspension components.

OR

2) They don't compress the suspension, and as the trailer bounces up and down the straps are snapped from loose to taut over and over again until they break.

SOLUTION: To solve these issues, Mac's has designed a wheel net that grabs the ATV where the stress should be - at the tires. This method allows the ATV to move the way it was designed without undue strain on the straps. Four nets (two large, two medium) come with all the mounting hardware you need and a slick Mac's storage bag to boot.



MAC'S TECH TIP

Tech Tip #1 - When installing the anchor plates, select a point slightly ahead and behind each tire. This will ensure an even weight distribution and keep everything where you left it.

Tech Tip #2 - Make sure your tires are properly inflated when using these nets - they need to hold their shape for secure travel.



STRAP COLORS

ATV WHEEL NET PACK

BLACK	BLUE	RED	YELLOW	GREEN	PURPLE	SILVER
-------	------	-----	--------	-------	--------	--------

w/Anchor Plate Assembly

510041	510042	510043	510044	510045	510046	510047
--------	--------	--------	--------	--------	--------	--------



w/Flat Snap Hook

510101	510102	510103	510104	510105	510106	510107
--------	--------	--------	--------	--------	--------	--------



ATV Wheel Nets fit 25 x 8.5" and 25 x 10.5".



POWER SPORTS

UTV

UTV PACK

Mac's Side by side UTV Tie-Down Pack When the UTV market started exploding, we needed something a little heftier than our standard Moto pack, and still not as costly as our car tie-down kits. This 5,000# kit is what we came up with. Four 7' (6' working length) combo straps, identical in function to our Super pack, but changed a bit for better UTV geometry come in this set, along with four Strap Wraps. We put it all together with our classic duffle bag for a complete kit; everything you need to strap down one UTV up to 1650#! Only available in Black.



PHOTO COURTESY OF ATV ILLUSTRATED

UTV PACK INCLUDES

- (4) 7' 5K* Combination Axle Straps
- (4) Strap Bands
- (1) Mac's Black Duffle Bag



BLACK ONLY

SIDE BY SIDE UTV PACK

999105





LIGHT CARGO GENERAL UTILITY



STRAP BANDS

A great method for keeping your straps tidy.



SMALL BLACK DUFFLE BAG

A heavy-duty bag designed to store your straps and hardware. Plenty of room for storage of 4-6, 1" tie downs.

UTILITY RATCHET PACK INCLUDES

- (4) 1" x 6' or 1" x 10' Ratchet Straps
- (4) 1" x 18" Soft Loops
- (4) Strap Bands
- (1) Small Black Duffle Bag

UTILITY CAM PACK INCLUDES

- (4) 1" x 6' or 1" x 10' Cam Straps
- (4) 1" x 18" Soft Loops
- (4) Strap Bands
- (1) Small Black Duffle Bag



STRAP COLORS

	BLACK	BLUE	RED	YELLOW	GREEN	PURPLE	SILVER
--	-------	------	-----	--------	-------	--------	--------

UTILITY RATCHET PACK

6'	510001	510002	510003	510004	510005	510006	510007
10'	510111	510112	510113	510114	510115	510116	510117

UTILITY CAM PACK

6'	510121	510122	510123	510124	510125	510126	510127
10'	510131	510132	510133	510134	510135	510136	510137

STRAP BANDS

416008

SMALL BLACK DUFFLE BAG

610001





LIGHT CARGO

STRAPS



SOFT LOOPS (PAIR)

LENGTH	BLACK	BLUE	RED	YELLOW	GREEN	PURPLE	SILVER
18"	111218	112218	113218	114218	115218	116218	117218
24"	111224	112224	113224	114224	115224	116224	117224

1" RATCHET STRAPS

6'	111106	112106	113106	114106	115106	116106	117106
8'	111108	112108	113108	114108	115108	116108	117108
10'	111110	112110	113110	114110	115110	116110	117110
12'	111112	112112	113112	114112	115112	116112	117112

1" CAM STRAPS

6'	111006	112006	113006	114006	115006	116006	117006
8'	111008	112008	113008	114008	115008	116008	117008
10'	111010	112010	113010	114010	115010	116010	117010
12'	111012	112012	113012	114012	115012	116012	117012

INTEGRAL SOFT LOOP

Ratchet w/ S-Hooks							
6'	111306	112306	113306	114306	115306	116306	117306
Ratchet w/ Flat Snap Hooks							
6'	111406	112406	113406	114406	115406	116406	117406
Cam Buckle w/ S-Hooks							
6'	111506	112506	113506	114506	115506	116506	117506

INTEGRAL SOFT LOOP RATCHET WITH VINYL COATED S-HOOKS

Constructed with a flat snap hook on the running end for maximum safety, these straps integrate a soft loop with flat snap hook and D-Ring combo. Time-tested for safe, convenient load transportation. Rated at 2,800 lbs.* max.



INTEGRAL SOFT LOOP RATCHET WITH FLAT SNAP HOOKS

A Mac's exclusive! This assembly integrates a ratchet strap with a soft loop. No more looking for lost soft loops. Vinyl coated S-hook on running end. Rated at 2,800 lbs.* max.



INTEGRAL SOFT LOOP CAM WITH VINYL COATED S-HOOKS

Just like the above strap, but made with a cam buckle and S-hooks for lighter loads. Safe working load of 400 lbs.*.



SOFT LOOPS

The perfect addition to a ratchet or cam buckle strap. Eliminates metal hardware contacting the load. Ideal for looping around handle bars, triple trees, etc. Made from 4,000 lb.* double-stitched webbing. (Sold in pairs)



1" RATCHET STRAP

Made with high-quality, easy-to-operate, wide-handle ratchet and large vinyl-coated S-hooks. Constructed of 4,000 lb.* polyester webbing and rated at 2,800 lbs* max.



1" CAM STRAPS

This strap uses a heavy-duty cam buckle that prevents slipping. Made with large 4,000 lb.* polyester webbing and rated at 1,200 lbs* max.

1" CUSTOM STRAPS

FIXED END HARDWARE



1" STRAP



TENSIONER



RUNNING END HARDWARE

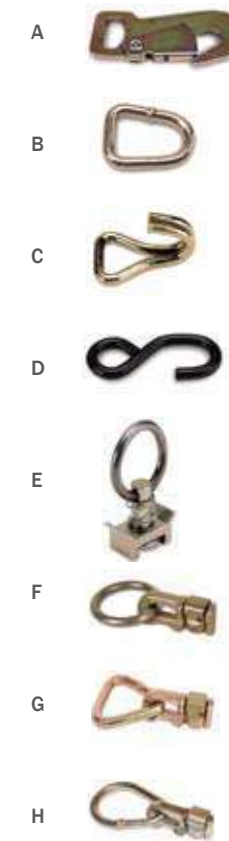

CUSTOM ORDER ID CODE

FIXED / RUNNING END HARDWARE:

- A Flat Snap Hook
- B D-Ring
- C Wire Hook
- D Vinyl Coated S-Hook
- E VersaTie™ Single Stud Ring
- F VersaTie™ Double Stud Ring
- G VersaTie™ Idler
- H VersaTie™ Double Stud Pear Ring

STRAP LENGTH:

- 72", 96", 120", 144"
- Custom

STRAP COLOR:

- K Black
- B Blue
- R Red
- Y Yellow
- G Green
- P Purple
- S Silver

TENSIONER:

- M Ratchet
- N Ratchet Stainless Steel
- P Cam Tensioner

HOW TO ORDER CUSTOM 1" TIE-DOWN STRAPS

To order a 1" custom strap, choose the necessary components of your desired strap, identify the corresponding identification code and list them in the following sequence:

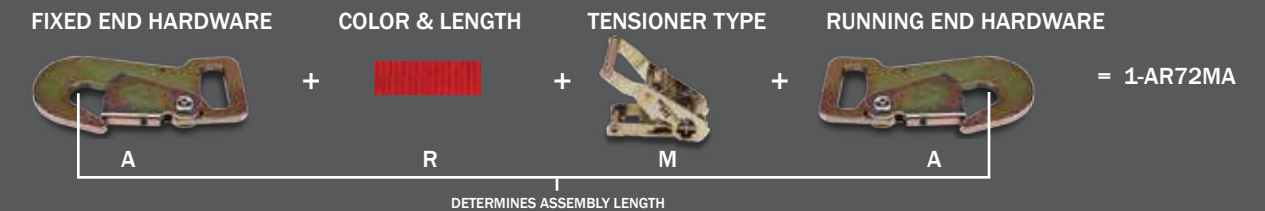

For example: To order a red 1" x 72" ratchet strap with a flat snap hook on the fixed end, and a flat snap hook on the running end (as shown above). The order number would be: 1-AR72MA

Note: Other hardware and webbing is available.



SPECIALTY GEAR

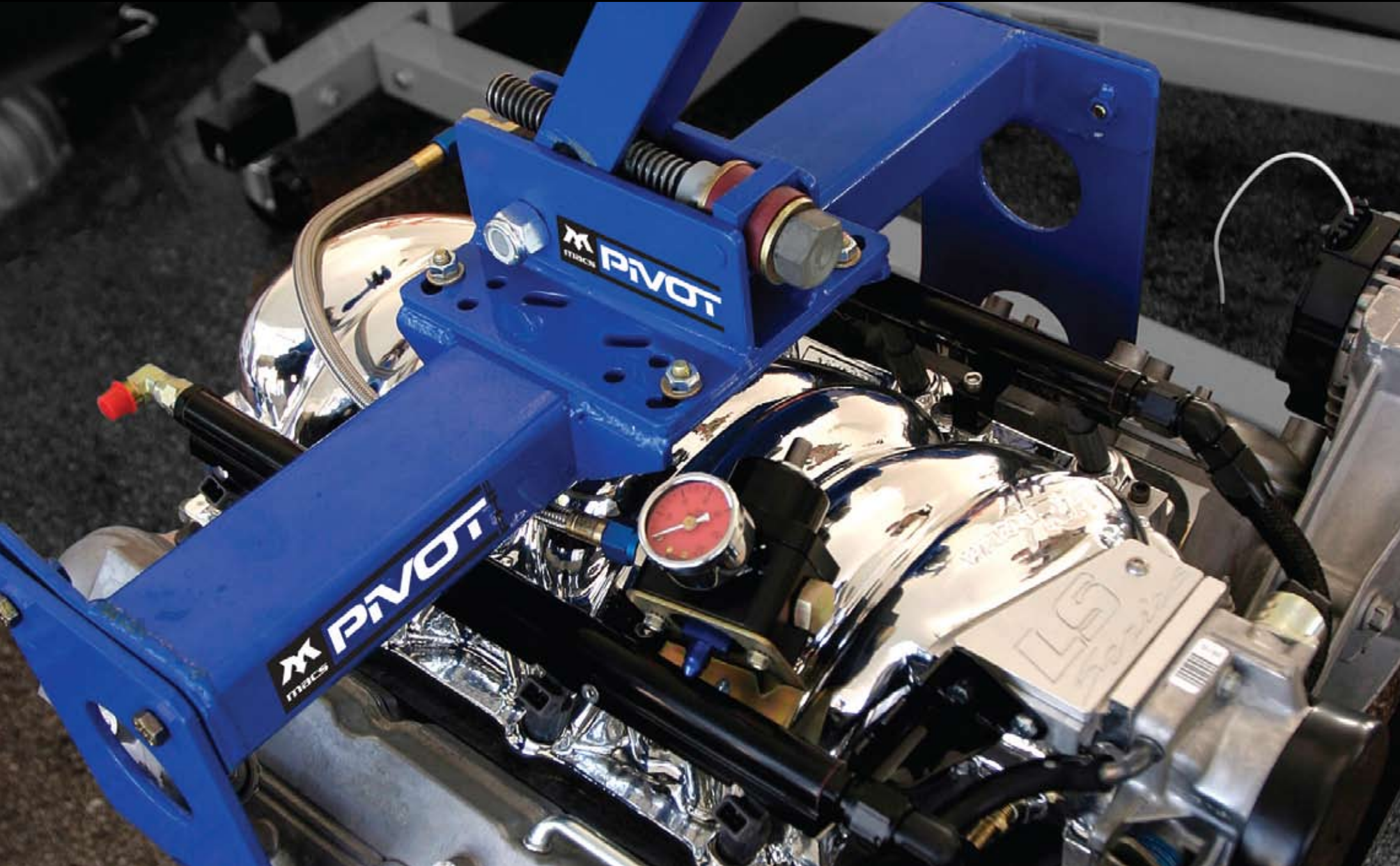

IT WAS QUICK AND STEADY THAT WON THE RACE

The new pivot from Mac's Tie-Downs allows the angle of the engine and trans to be easily adjusted while on the hoist to ease engine installation and removal of even the most unwieldy engine combinations. Thanks to their clever preparation, and the Mac's Pivot Plate, the Hot Rod Barn team completed the swap in just 35 minutes, from removal to running and driving. The beauty of the pivot is that you can control the engine and transmission with the turn of a ratchet, allowing the engine to glide right in.

JUSTIN DERMODY

of Hot Rod Barn Team
2010 Holley LS Fest Engine
Swap Champions



SPECIALTY GEAR

MAC'S PIVOT

1,200 lb* Capacity 701001

PIVOT ADAPTERS

Ford 5.0L 302 EFI 701302

Ford 4.6L & 5.4L OHC V8 701046

Ford 1932-1953
Flathead V8 701239

GM Throttle Body Injector 701987

GM 502 Ramjet
and Vortech 454 701002

GM LS-1 - LS-9 701350

GM V8 Fuel Injection 701305

Mac's always has more adapters in development.



MAC'S PIVOT

Removing and replacing engines can be a time-consuming process that risks damaging your perfect paint job. Save time, energy, and keep your paint and firewall flawless with Mac's Pivot, a rock solid articulating engine lift plate that tilts the engine and transmission up to 35 degrees with a few quick turns of a ratchet.





SPECIALTY GEAR

CHASSIS STABILIZER

Mac's Chassis Stabilizer is the perfect companion to most any tie-down system. Simply slide the deflated stabilizer under the chassis and inflate it. Inflated, the stabilizer will cushion the harsh effects of trailering.

CHASSIS STABILIZER INCLUDES

- 18" Chassis Stabilizer
- Hose Kit
- Gate Valve



WALL BRACKET



CHASSIS STABILIZER

Deflated height 1.75". Inflated height 10".
18" Diameter 700007

Deflated height 1.125". Inflated height 4".
Rectangular 700008

WHEEL CRADLE

Dragster Front 700005

L-Shaped Chock 700004

PIT RAMP

700010

FLOOR JACK CRADLE

700001

WALL BRACKET

700002

RECTANGULAR WALL BRACKET

700011

RECTANGULAR STABILIZER

Mac's Rectangular Stabilizer is designed for low clearance cars and for use with beaver tail trailers. It's sleek 1 1/8 inch height design allows it to slide under the lowest race cars. It is recommended for applications where the chassis is 1 1/8 inches to 3 inches from the trailer floor.

RECTANGULAR STABILIZER INCLUDES

- Rectangular Stabilizer
- Hose Kit
- Gate Valve



RECTANGULAR WALL BRACKET



L-SHAPED CHOCKS



PIT RAMP



FLOOR JACK CRADLE



WHEEL CRADLE

Mac's rubber wheel cradles keep everything in the same place, every time. They do an excellent job preventing wheel movement and augmenting tie-down straps.





SPECIALTY GEAR

TRAIL D-VISE INCLUDES

- Hitch Pin
- Clip
- Handle



FIRE EXTINGUISHER BRACKETS

Why bother having a fire extinguisher if you can't get to it in time to make a difference?

Now Mac's Custom Tie-Downs has a solution: the new Quick-Release Fire Extinguisher Bracket combines Mac's trademark rugged construction with the convenience of a quick-release pin and the ability to accommodate most standard hand-held extinguishers.

Like all Mac's products, the Quick Release Extinguisher Bracket is made in the USA, featuring CNC machined billet aluminum construction and stainless steel hardware. The bracket is available with tubular or flat panel mounts for use on roll bars, cages, floor pans or most anywhere within easy reach.

TRAIL D-VISE 797979

FIRE EXTINGUISHER BRACKETS

Flat Panel Mount	712830
Tubular Mount	
1.25" dia.	712821
1.5" dia.	712822
1.75" dia.	712824
2.00" dia.	712826



FLAT PANEL BRACKETS



TUBULAR MOUNT

TRAIL D-VISE

Now even better. Mac's has improved this great product by adding pipe jaws, an integrated handle and a convenient bottle opener. In addition rock-crusher tough "Slip-Not"™ material is used for jaw faces. The new cross drilling allows the Vise to rotate on 90° increments.

- Fits any standard 2" x 2" receiver tube/trailer hitch
- Opens to more than 8" - Wide enough to press most U-joints
- "Slip-Not"™ material for main jaws, plus triple pipe jaws for the ultimate grip

Mac's Trail D-Vise make those remote repairs easier and more effective. Simply slide the D-Vise into your receiver, pin it and you have a stout vise in the middle of nowhere!

The Trail D-Vise gives you workbench vise capabilities right off the back of your vehicle. Use for fabrication, repair, welding, cutting, pressing, straightening and more!





SPECIALTY GEAR

JEEP® BOX INCLUDES

- Integral Locking Floor Cover
- Moveable Dividers
- Versatite Tie-Down Track
- Removable Tie-Down Fittings
- Sliding Drawer Cover



FULL HEIGHT MOVEABLE DIVIDERS



ALUMINUM HINGE POINT



MITERED CORNERS ON VT TRACK

JEEP® BOX

Rugged all-aluminum construction, OEM quality fit and finish. Lightweight and customizable, stow cargo out of the elements and away from thieves. Drawer lid makes perfect work table for food prep while camping.

The Mac's Jeep Box is easily installed behind the rear seats in any 2007+ Jeep Wrangler 4-door. The factory floor storage wells are still accessible due to the Jeep Box's innovative tilting design. Lightweight powdercoated aluminum construction allows the Jeep Box to include a fully locking drawer and a separate lock to keep the unit itself safely secured in the back of the Jeep. The factory floor cover is replaced with an aluminum integral floor that is part of the box for maximum security and durability.

To offer double protection against the elements, the interior drawer features a gasket on all sides, so rain and mud will all stay on the outside, where it belongs. The Mac's Jeep Box utilizes the factory rear seat bolt holes for mounting, but does not require the removal of the rear seats. Every Jeep Box comes standard with an integral locking floor cover, moveable dividers for modular interior space, Mac's famous VersaTie tie-down track, removable fittings for even more gear space and a sliding drawer cover to offer more flat work surface.

The Jeep Box also features an exclusive pivot mount that allows you to swing the entire unit up and forward, out of the way in case you need access to the factory storage wells. The entire storage system, from mounting plate to powdercoated drawer unit can be installed in 15 minutes without any drilling, allowing for easy removal if desired.

JEEP BOX 2007+ 4-DOOR

702010



SPECIALTY GEAR

CANOPY PARTS

AUTOMATIC LATCHING RAFTER END

Mac's aluminum rafter ends eliminate the hardest part of canopy frame manufacturing. The automatic latching mechanism allows the rafter to positively connect to the padeye without requiring the end user to climb the trailer. This can be a terrific selling point when your padeyes are mounted 14' up. With our parts, you can erect and dismantle the canopy frame while standing on the ground.

RAFTER END 2" X 2"

Rafter end designed to fit 2" x 2" x .125" tubing with internal cable routing.



RAFTER END

2" x 2" 632201

2" x 3" 632301

GUSSETED PADEYE

2" x 4" 471002

RAFTER END 2" X 3"

Rafter end designed to fit 2" x 3" x .125" tubing with internal cable routing.



GUSSETED PADEYE 2" X 4"

Mac's padeyes feature fully stainless steel construction. Each unit is expertly T.I.G. welded, then electropolished and passivated sealed for maximum corrosion resistance.

