

Installation Instructions

® I - Sheet Number LUND10740 Rev.C

LUND OE Style No Drill Bracket

For proper installation and best possible fit, please read all instructions BEFORE you begin.

Important Safety Information



- To be used with Lund® branded products only.
- Do not stand on Lund running board or bracket while vehicle is in motion.
- Do not exceed 350 lbs. weight on the Lund bracket system.
- Do not use the brackets as a jacking point for the vehicle.
- Do not use the bracket system or running boards to fasten cargo.
- Periodically check all components for tightness.
- Be sure to wear safety glasses while installing brackets.
- When using power tools, read and understand all operating instructions.

Contents

NOTE: Actual product may vary from illustration.

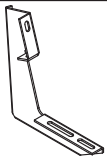

Front Bracket
(M-2705) (2)

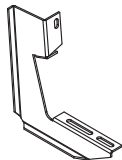

Center Bracket
(M-2750) (2)

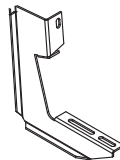

Rear Bracket
(M-2704) (2)



U-Nut (5/16\"-18)
(6)



5/16\"x3/4\"
Square Bolts (12)



5/16\" Nylock Nuts
(12)



Washers
(12)



Flange Nut
(5/16\"-18) (6)



Black Flange Bolt
(5/16\"-18 x 3/4\") (12)

Tools Required



Safety Glasses



Socket Wrench

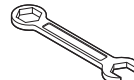

Wrench
Llave



Socket Set

Preparation Before Painting / Installation

- Park your vehicle in a clean, level location. Check to make sure the vehicle is in park, or for manual drive models, place the transmission in first gear. Engage the parking brake.
- Unpack the bracket kit and identify the parts according to the content descriptions.
- A trial fit is recommended to ensure proper positioning and fit.
- Check fit of parts before painting as we will not accept the return of modified or painted parts.

Installation Steps

NOTE: Actual application may vary slightly from illustrations.

Identify the mounting locations for each bracket by looking under the vehicle and finding the holes in the pinch weld.

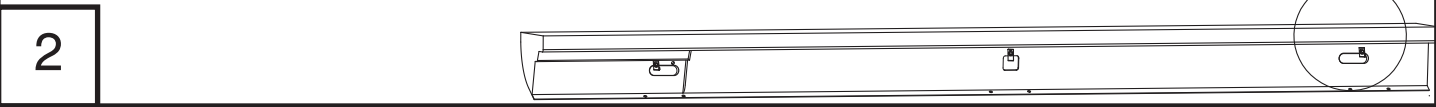
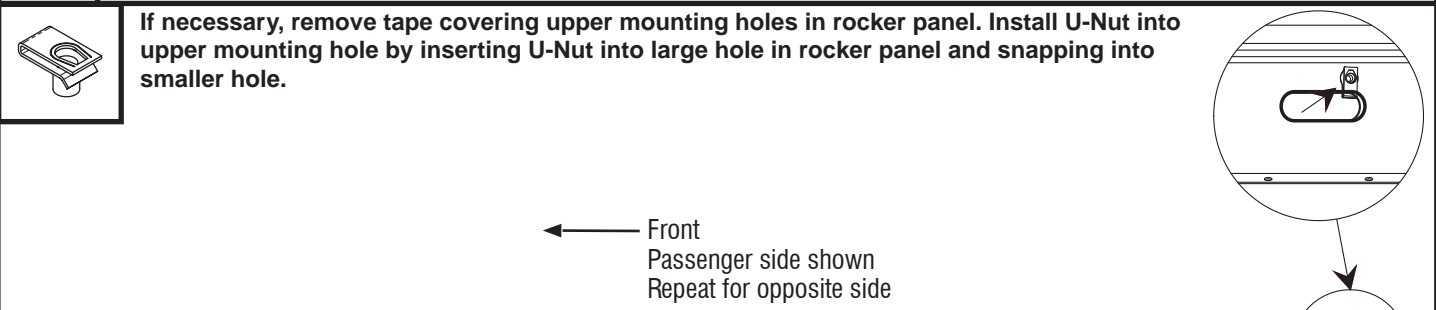
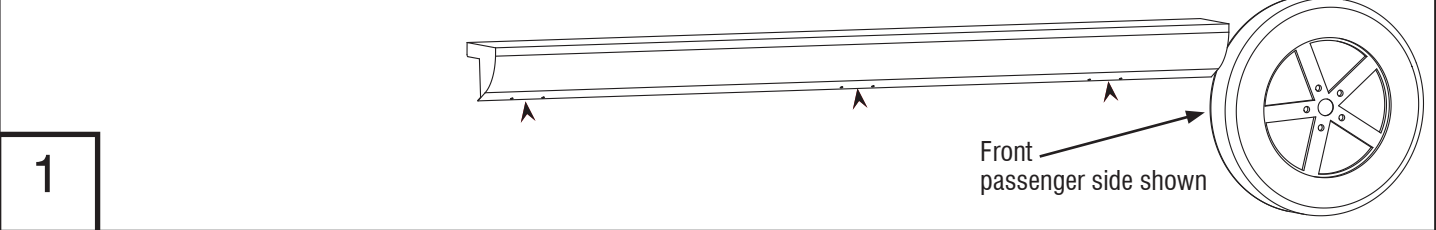

Begin bracket installation by locating bracket on inner rocker panel so that the hole in the bracket lines up with the U-Nut. (M-2705-Front goes in front location, M-2750 Center in the center & M-2704 Rear in rear locations). Insert a flange bolt through hole and thread into U-Nut. Finger tighten bolts. Complete bracket installation by adjusting bracket so that lower holes in bracket line with the holes in the pinch weld. Insert bolt through pinch weld and bracket, and secure with flange nut. Finger tighten hardware.

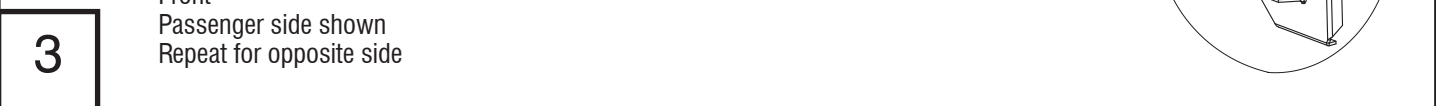
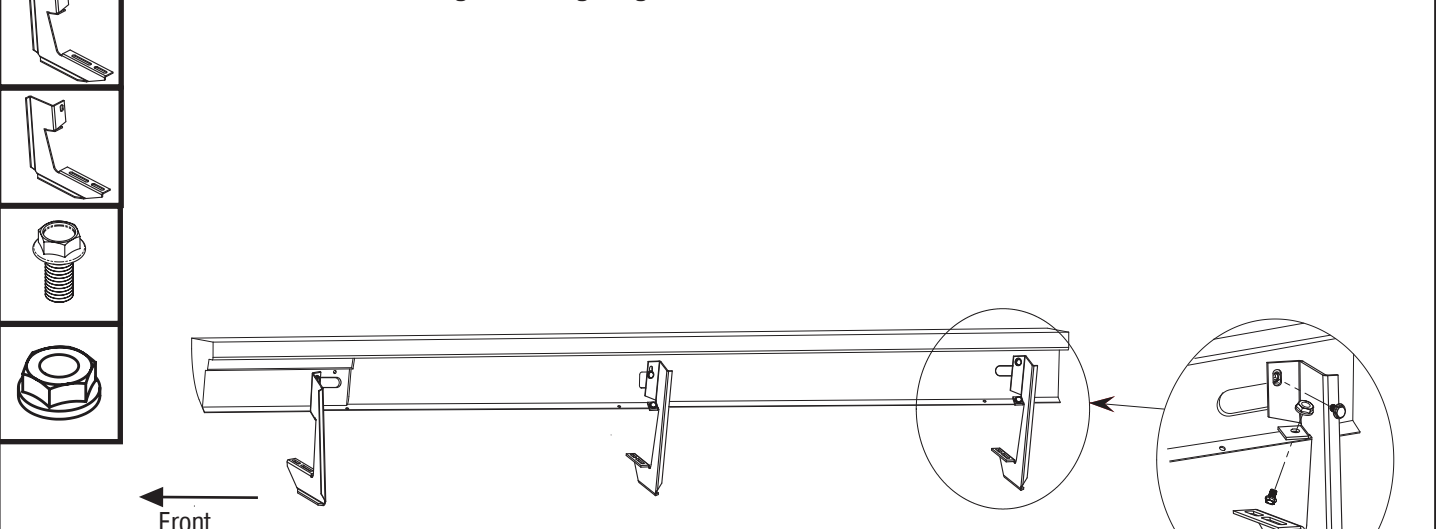

Install square bolts into the shaded outer channels. One (1) bolt in each channel per bracket to attach boards.

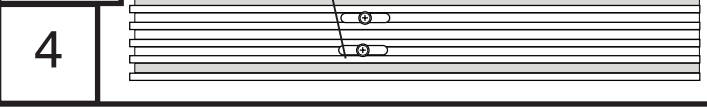
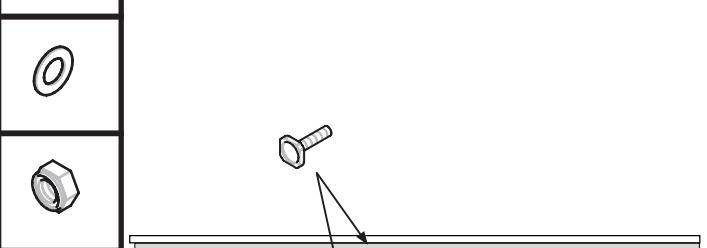

Attach boards to brackets. Tighten all Fasteners.

