

LUND® EZ BRACKET

300027
300028

PICKUP, F150 SUPERCREW & F250
LIGHT DTY SUPERCREW • 2001-03

PICKUP, F150 EXT CAB • 1997-03
P.N 300027

PICKUP, F150 STD CAB • 1997-03
P.N. 300028

Thank you for purchasing one of the many quality items manufactured by Lund Industries, Inc. We take the utmost pride in our products and want you to enjoy years of satisfaction from your investment.

This product has been designed and engineered to correctly fit and complement only the vehicle(s) listed in the heading.

For easiest installation and the best final appearance, read the complete instruction BEFORE you begin.

Please follow all instructions for the proper installation of this part to the vehicle. Lund Industries, Inc.



Brackets



Support Brackets



Self Tapping Screws



1/4" bolts



5/16" Bolts



1/4" Washers



1/4" Nuts

TOOLS NEEDED FOR INSTALLATION



Socket Set



Standard Wrench Set



Drill



Hammer



Floor Jack



5/16" Drill Bit



1/8" Drill Bit



Silicone



Center Punch

INSTALLATION INSTRUCTIONS

EZ BRACKETS

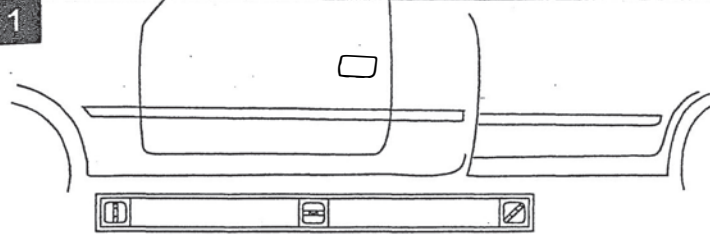

NOTE: Place truck on level surface.

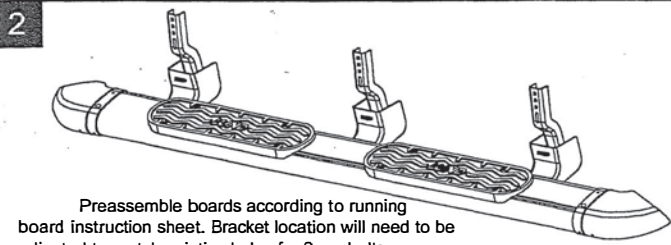

Preassemble boards according to running board instruction sheet. Bracket location will need to be adjusted to match existing holes for 8mm bolts.

P.N. 300026 = 4 Brackets / side
P.N. 300027 = 3 Brackets / side
P.N. 300028 = 2 Brackets / side

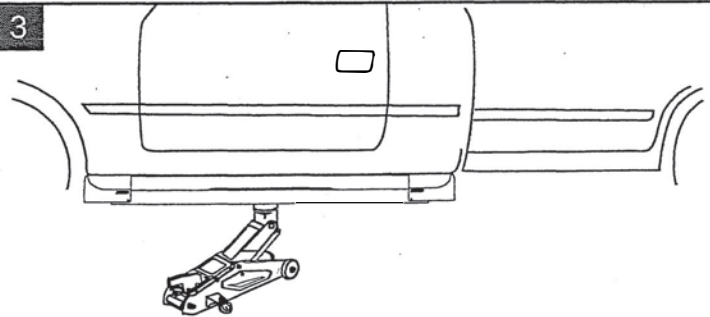

NOTE: Raise board into place with floor jack. Center board on rocker panel.

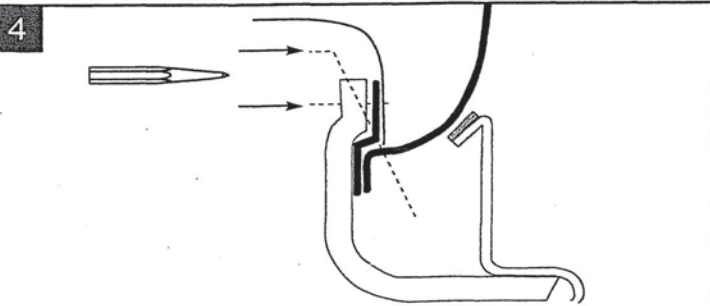

NOTE: Using bracket as a guide, mark the top and bottom hole locations in rocker panel.

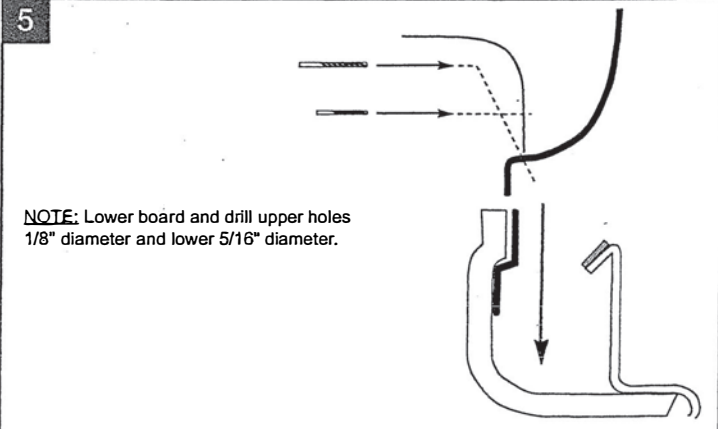

NOTE: Lower board and drill upper holes 1/8" diameter and lower 5/16" diameter.

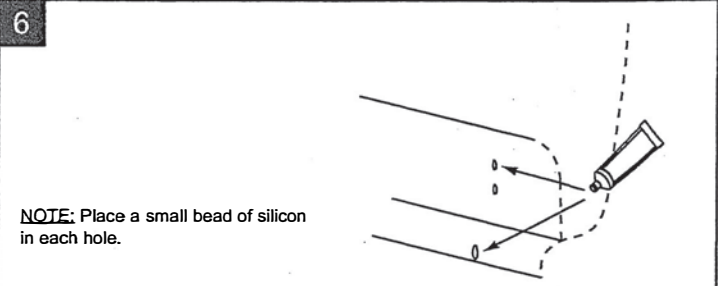

NOTE: Place a small bead of silicon in each hole.

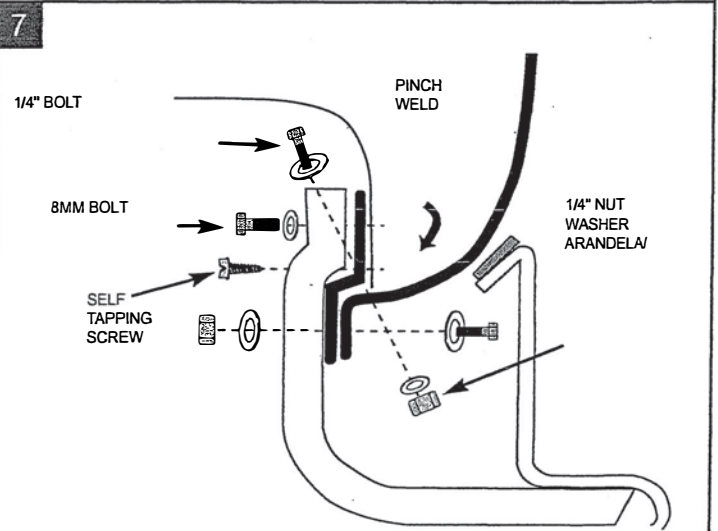

NOTE: Raise board and tighten center hole iwht #14x1 screw. Tighten pinch weld hole using a 1/4" bolt, washers, and nut. Tighten factory location with 8mm bolt and washer.