



# EZ BRACKET™

300013  
300014

PICKUP RAM 1500 QUAD CAB • 1994-01  
RAM 2500 & 3500 QUAD CAB • 1994-02  
P.N. 300013

PICKUP RAM 1500 STD CAB • 1994-01  
RAM STD CAB 2500 & 3500 • 1994-02  
P.N. 300014

*Thank you for purchasing one of the many quality items manufactured by Lund Industries, Inc. We take the utmost pride in our products and want you to enjoy years of satisfaction from your investment.*

**This product has been designed and engineered to correctly fit and complement only the vehicle(s) listed in the heading. For easiest installation and the best final appearance, read the complete instruction BEFORE you begin.**

**Please follow all instructions for the proper installation of this part to the vehicle. Lund Industries, Inc.**

## INSTALLATION KIT INCLUDES

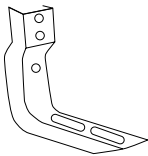

Brackets



Self Tapping Screws



1/4" bolts



1/4" Washers



1/4" Nuts

## TOOLS NEEDED FOR INSTALLATION



Socket Set

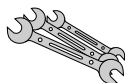

Standard Wrench Set

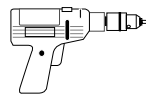

Drill



Hammer

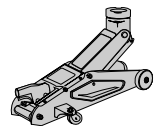

Floor Jack



5/16" Drill Bit



1/8" Drill Bit



Silicone



Center Punch

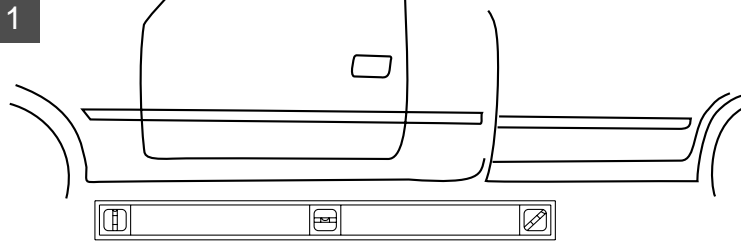

**NOTE:** Place truck on level surface.

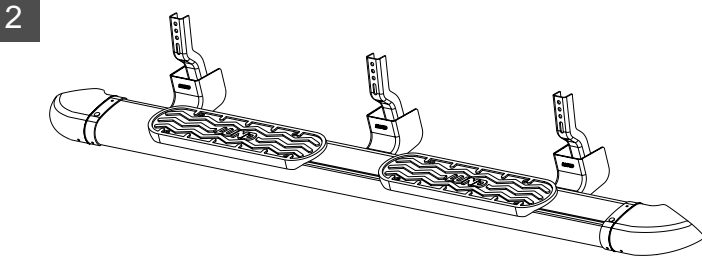

**NOTE:** Preassemble boards according to running board instruction sheet.

P.N. 300013 = 3 Brackets / side  
 P.N. 300014 = 2 Brackets / side

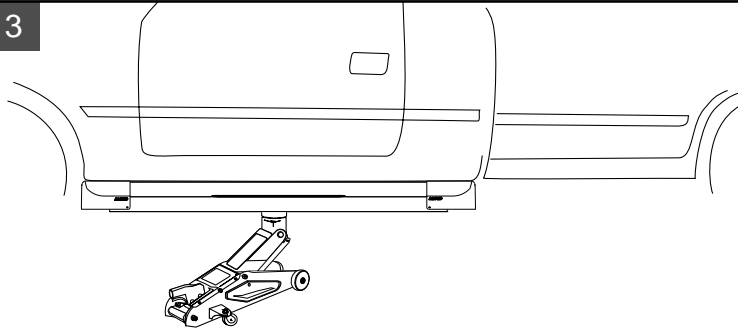

**NOTE:** Raise board into place with floor jack. Center board on rocker panel.

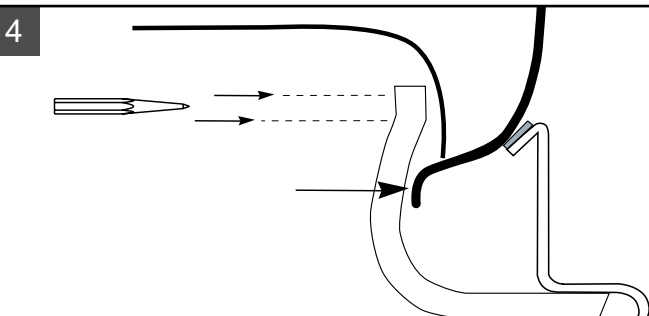

**NOTE:** Using bracket as a guide, mark the top and bottom hole locations in rocker panel.

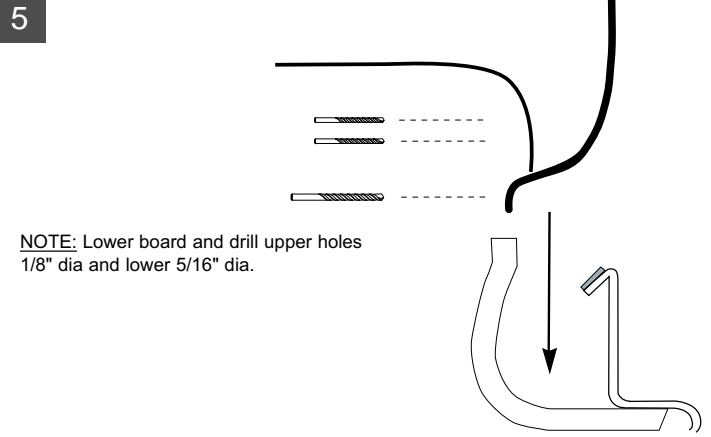

**NOTE:** Lower board and drill upper holes 1/8" dia and lower 5/16" dia.

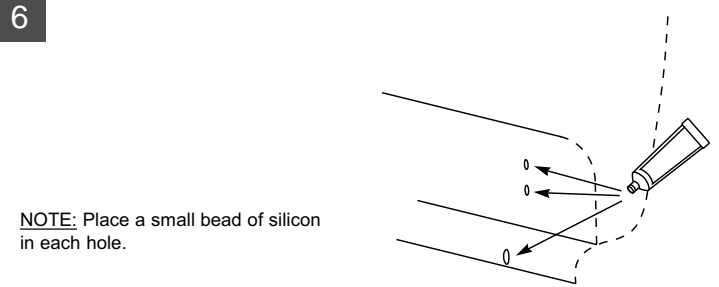

**NOTE:** Place a small bead of silicon in each hole.

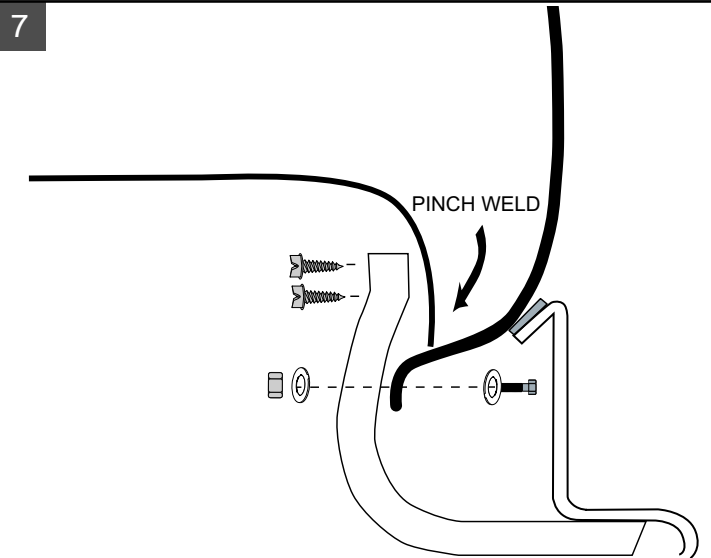

**NOTE:** Raise board and tighten upper holes with self tapping screws. Tighten pinch weld using a 1/4" bolt, washers and nut.