

Installation Instructions

I - Sheet Number I-PW00468701 Rev. A



Premium Style. Lasting Performance.

For proper installation and best possible fit, please read all instructions BEFORE you begin.

Care and Cleaning

- Wash only with mild soap & dry with a clean cloth.
- Every 3 months or 5000 miles check the cover tension and all components for tightness.

Congratulations!

You have purchased one of the many quality Lund® branded products offered by Lund International, Inc. We take the utmost pride in our products and want you to enjoy years of satisfaction from your investment. We have made every effort to ensure that your product is top quality in terms of fit, durability, finish and ease of installation.

INSTALLATION INSTRUCTIONS

PART# 23986004/ 24086004

IMPORTANT ALERT: GM uses a very strong thread-locking compound on all body bolts. Use of an air assisted impact ratchet can cause damage to the threads on factory body mount bolts and the internal nut assembly because of this thread locking compound.

We only recommend the use of hand tools to slowly remove and reinstall body mount bolts on all GM vehicles.

PROCEDURE:

CRITICAL INFORMATION: If during the removal process, it becomes increasingly difficult to unscrew the body mount bolt with hand tools, tighten the bolt several rotations to clear the thread locking compound from the threads, then reverse direction and continue to unscrew until the body mount bolt is out. Repeat this process as necessary on all GM body mount bolts. Use of an appropriate anti-seize compound is highly recommended for re-installation. Tighten body mount bolt to factory torque specifications for your particular model year.

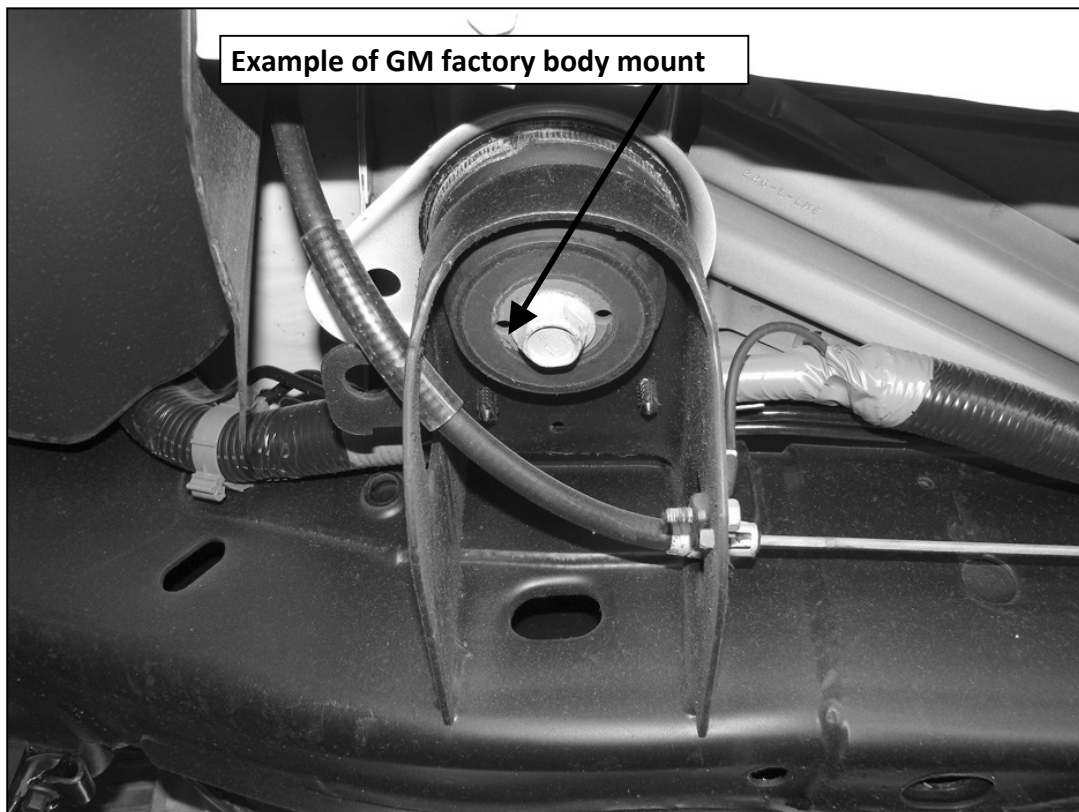

PARTS LIST:

1	Driver/Left Side Bar	4	12mm x 32mm x 3mm Flat Washers
1	Passenger/Right Side Bar	2	12mm Lock Washers
1	Driver/Left Front Mounting Bracket	2	12mm Hex Nuts
1	Passenger/Right Front Mounting Bracket	2	10mm Nut Plates
1	Driver/Left Side Center Mounting Bracket	6	10-1.50mm x 30mm Hex Bolts
1	Passenger/Right Side Center Mounting Bracket	10	10mm x 20mm OD x 2mm Flat Washers
1	Driver/Left Rear Mounting Bracket	6	10mm Lock Washers
1	Passenger/Right Rear Mounting Bracket	4	10mm Hex Nuts
1	Driver/Left Front Support Bracket	12	8-1.25mm x 25mm Hex Bolts
1	Passenger/Right Front Support Bracket	12	8mm ID x 24mm OD x 2mm Flat Washers
2	Center Support Brackets	12	8mm Lock Washers
2	12-1.75mm x 30mm Hex Bolts		

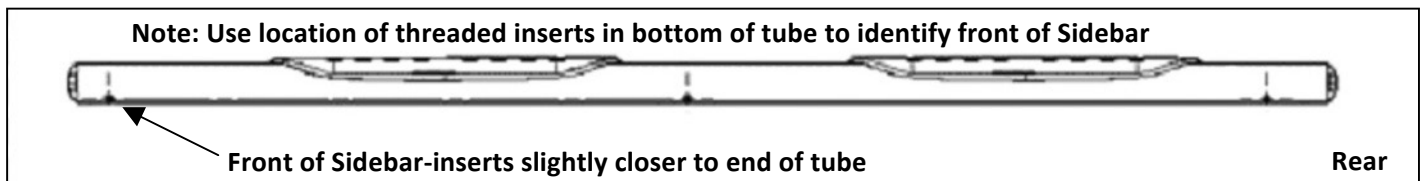
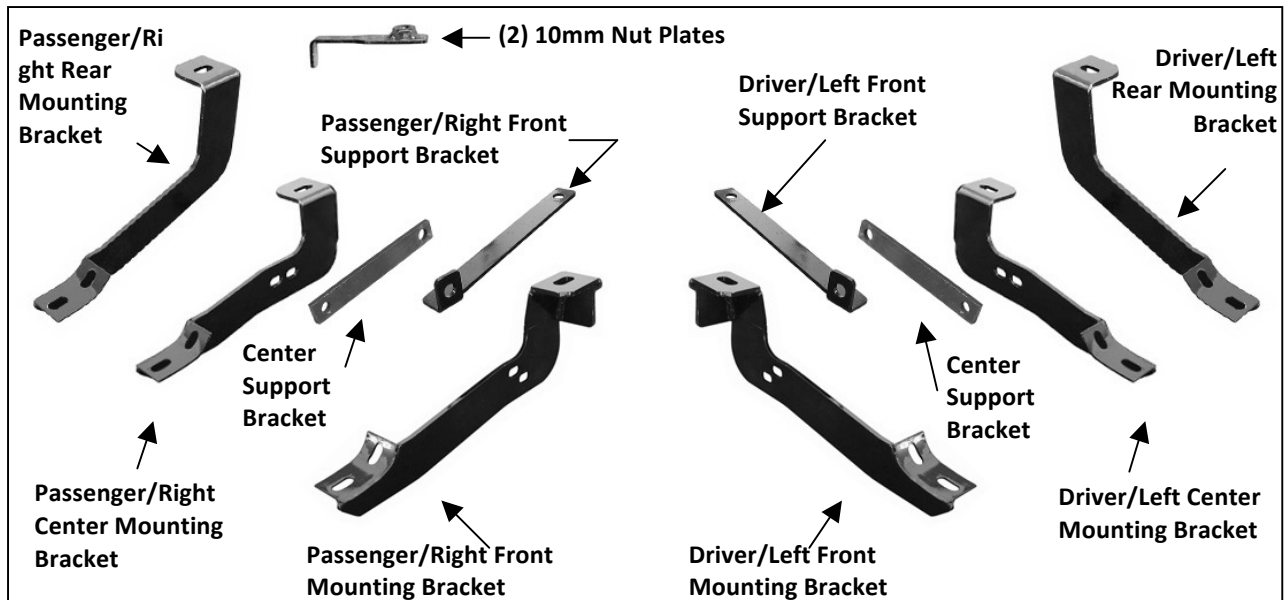

PROCEDURE:

REMOVE CONTENTS FROM BOX. VERIFY ALL PARTS ARE PRESENT. READ FACTORY BODY BOLT REMOVAL INSTRUCTIONS AND INSTALLATION INSTRUCTIONS CAREFULLY BEFORE STARTING INSTALLATION.

1. Start the installation under the driver side of the vehicle and remove the front, center and rear body mount bolts. Do not remove bushings.

2. Hang the driver side front, center and rear Mounting Brackets from the body mounts in the order pictured above using the factory hex bolts, **(Figure 1)**. Do not tighten hardware at this time.
3. Locate the two factory holes in the bottom of the frame towards the front of the vehicle. Insert (1) 10mm Nut Plate, **(Figure 2A)**, into the oval hole and line up the threaded nut with the forward round hole, **(Figure 2B)**. **NOTE:** Nut Plate and Support Bracket are not required on 2011-12 25-3500 models.
4. Attach the driver side front Support Bracket to the Nut Plate with (1) 10mm x 30mm Hex Bolt, (1) 10mm Lock Washer and (1) 10mm Flat Washer, **(Figures 3 & 4)**. Do not tighten hardware at this time.

1500 Models:

Attach the bent end of the Front Support Bracket to the outside hole in the Front Mounting Bracket with (1) 10mm x 30mm Hex Bolt, (2) 10mm Flat Washers, (1) 10mm Lock Washer and (1) 10mm Hex Nut, **(Figure 3)**. Do not tighten at this time.

Up to 2010 25-3500 Models-Front Support Bracket not required on 2011-12 25-3500 Models:

Note that the Front Support Bracket will not reach up to the Mounting Bracket, **(Figures 3 & 4)**. Tighten the Support Bracket to the Nut Plate in the frame. Carefully push up on the Support Bracket until it reaches the inside hole in the Mounting Bracket, **(Figure 4)**. Bolt the Support Bracket to the hole in the Mounting Bracket with (1) 10mm x 30mm Hex Bolt, (2) 10mm Flat Washers, (1) 10mm Lock Washer and (1) 10mm Hex Nut, **(Figure 3)**. Do not tighten hardware at this time.

All 1500 and up to 2010 25-3500 Models-Center Support Bracket not required on 2011-12 25-3500 Models:

5. Move to the Center Mounting Bracket. Select (1) Center Support Bracket-note the two different sizes of mounting holes in the Bracket. Slide the end of the Center Support Bracket with the larger mounting hole between the factory body mount and the Center Mounting Bracket. Attach the Support Bracket to the body mount using the included (1) 12mm x 30mm Hex Bolt, (2) 12mm Flat Washers, (1) 12mm Lock Washer and (1) 12mm Hex Nut, **(Figures 5 & 6)**. Do not tighten at this time. **NOTE:** Larger hole on the Center Support Bracket mounts to body mount.
6. Attach the opposite end of the Support Bracket to the Center Mounting Bracket with (1) 10mm x 30mm Hex Bolt, (2) 10mm Flat Washers, (1) 10mm Lock Washer and (1) 10mm Hex Nut, **(Figures 5 & 6)**. Do not tighten at this time.
7. Carefully position the Driver Sidebar onto the Mounting Brackets. Attach the Sidebar to the Mounting Brackets with (6) 8mm x 25mm Hex Bolts, (6) 8mm Lock Washers and (6) 8mm Flat Washers, **(Figure 7)**. Do not tighten hardware at this time.
8. Level and adjust the Sidebar and tighten all hardware.
9. Repeat steps 2-8 for passenger Sidebar installation.
10. Do periodic inspections to the installation to make sure that all hardware is secure and tight.

To protect your investment, wax this product after installing. Regular waxing is recommended to add a protective layer over the finish. Do not use any type of polish or wax that may contain abrasives that could damage the finish.

For stainless steel: Aluminum polish may be used to polish small scratches and scuffs on the finish. Mild soap may be used also to clean the Sidebar.

For gloss black finishes: Mild soap may be used to clean the Sidebar.

5" OVAL STRAIGHT SIDE BAR
 2002-2013 SILVERADO/SIERRA 1500HD CREW CAB
 2004-2005 SILVERADO/SIERRA 1500LD CREW CAB
 2001-2013 SILVERADO/SIERRA 2500HD-3500 CREW CAB

Driver Side Installation Pictured

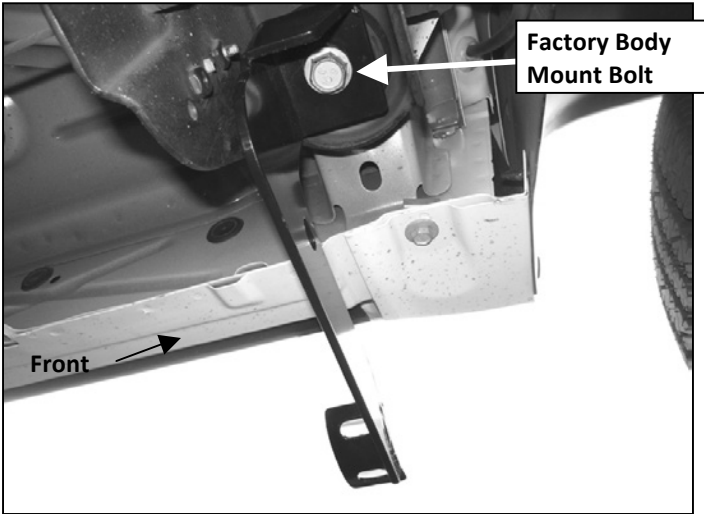

(Fig 1) Driver side front mounting bracket pictured



Fig 2A

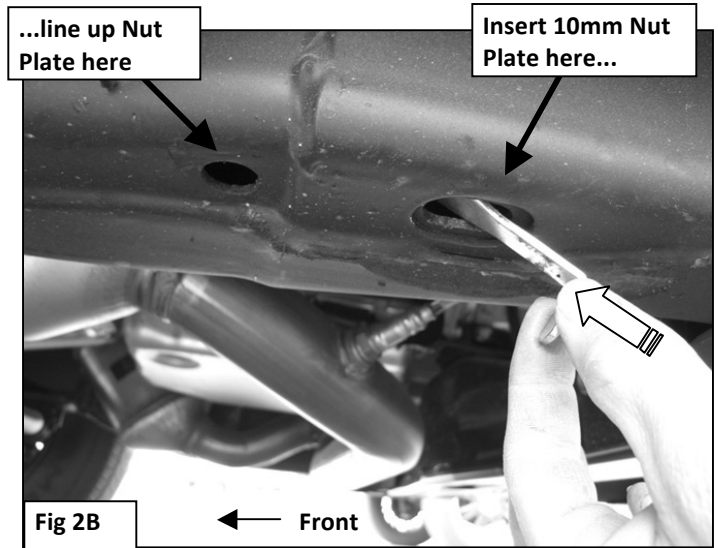
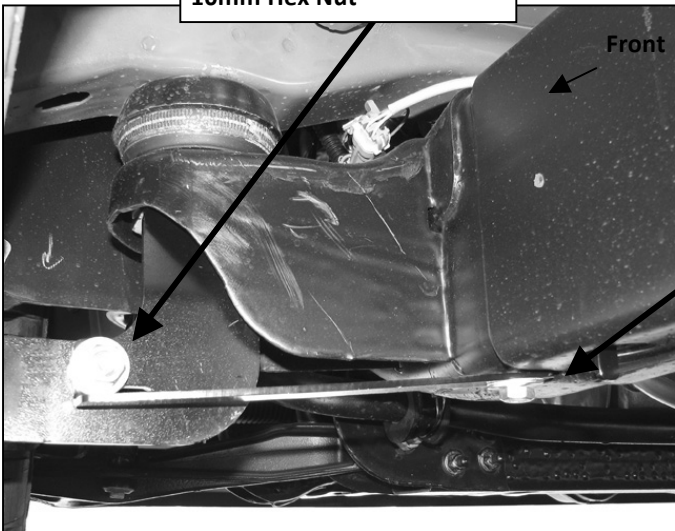

Fig 2B

10mm x 30mm Hex Bolt
 (2) 10mm Flat Washers
 10mm Lock Washer
 10mm Hex Nut



(Fig 3) 1500 Model Front Support Bracket Installation Pictured

10mm Nut Plate
 10mm x 30mm Hex Bolt
 10mm Lock Washer
 10mm Flat Washer

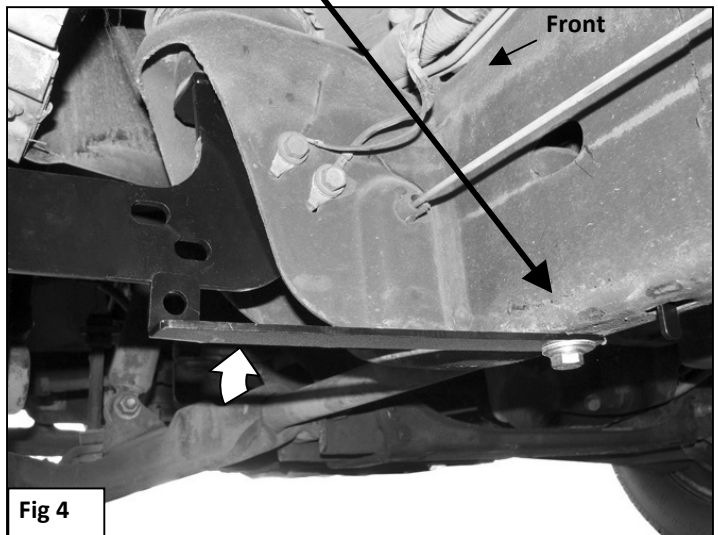

Fig 4

IMPORTANT NOTE: 25-3500 Model Front Support Bracket Installation Pictured
 Bend Support Bracket up by hand to meet the Front Mounting Bracket.

NOTE: Support Brackets not required on 2011-12 25-3500 Models

5" OVAL STRAIGHT SIDE BAR
2002-2013 SILVERADO/SIERRA 1500HD CREW CAB
2004-2005 SILVERADO/SIERRA 1500LD CREW CAB
2001-2013 SILVERADO/SIERRA 2500HD-3500 CREW CAB

Driver Side Installation Pictured

12mm x 30mm Hex Bolt
(2) 12mm Flat Washers
12mm Lock Washer
12mm Hex Nut

NOTE: Support Brackets not required on 2011-12 25-3500 Models

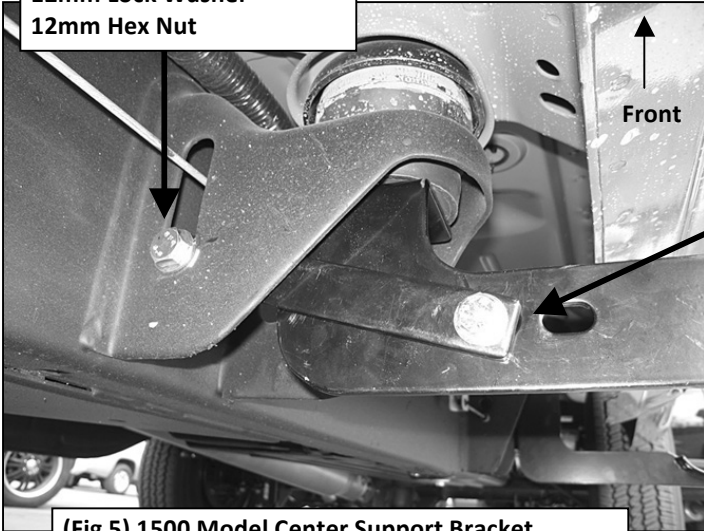

(Fig 5) 1500 Model Center Support Bracket Installation Pictured

10mm x 30mm Hex Bolt
(2) 10mm Flat Washers
10mm Lock Washer
10mm Hex Nut

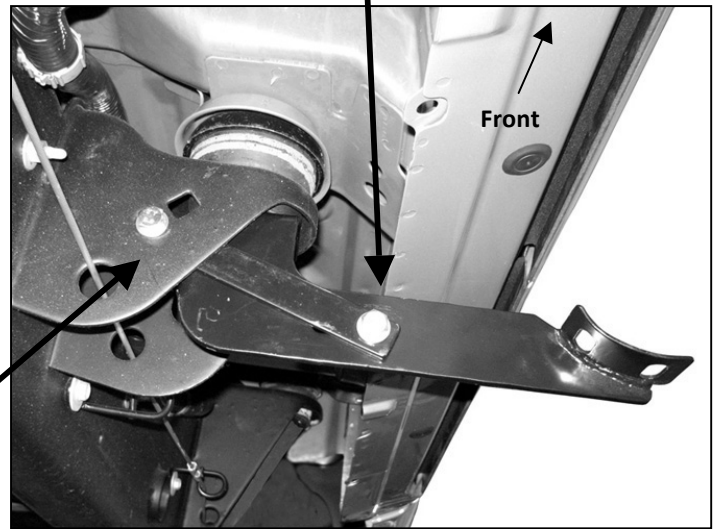

(Fig 6) 25-3500 Model Center Support Bracket Installation Pictured.

12mm x 30mm Hex Bolt
(2) 12mm Flat Washers
12mm Lock Washer
12mm Hex Nut

NOTE: Support Bracket not required on 2011-12 25-3500 Models

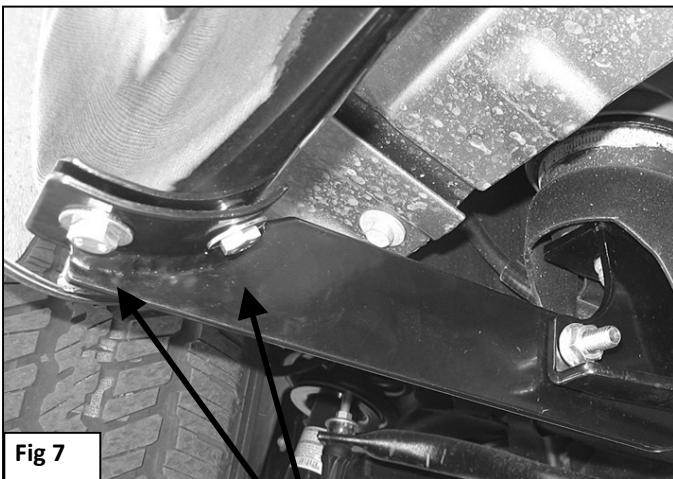

(2) 8mm x 25mm Hex Bolts
(2) 8mm Lock Washers
(2) 8mm Flat Washers



Complete Installation