

Installation Instructions

LUND Ventvisor® Deflector

Important Safety Information



- CAUTION - Before driving, ensure that the vent visor is properly secured to vehicle.
- Do not use automatic "brush-style" car washes.
- Do not use cleaning solvents of any kind.
- Periodically check all components for tightness.

Contents - 2 Piece Set **NOTE:** Actual product may vary from illustration.



Front Driver
Side Visor



Front Passenger
Side Visor



Alcohol Pad x2

Contents - 4 Piece Set



Front Driver
Side Visor

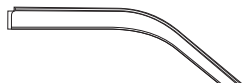

Front Passenger
Side Visor



Rear Driver
Side Visor



Rear Passenger
Side Visor



Alcohol Pad x4

Tools Required



Car Wash Supplies



Clean Towel

Preparation Before Painting / Installation

- A trial fit is recommended to ensure proper positioning and fit.
- Check fit of parts before painting as we will not accept the return of modified or painted parts.
- Wash and dry your vehicle to remove any debris and/or dirt from the installation area.

Installation Steps **NOTE:** Actual application may vary slightly from illustrations.

Alcohol
Pad

Clean the window channel
with an alcohol pad.

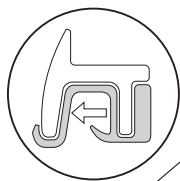

1

Remove tape liner from front flange. Peel back
2" of tape liner from each end of top flange.

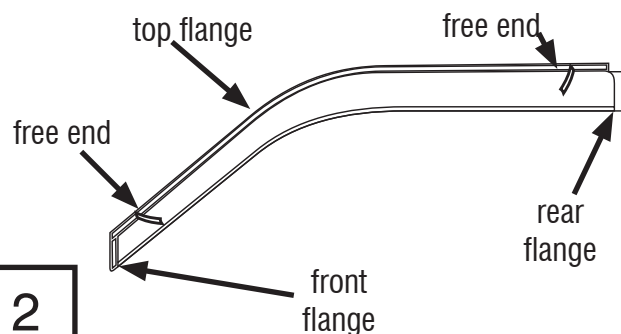

2

Installation Steps

NOTE: Actual application may vary slightly from illustrations.

Insert visor into window channel, rear flange first. Rear flange inserts between the trim and the exterior surface. The front & top flange slides into the window channel.

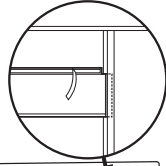

3

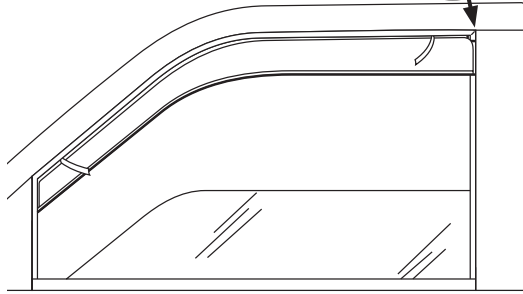

Remove tape liner by pulling on free ends. Raise window slowly and leave up for 24 hours to secure visor to window channel.

4

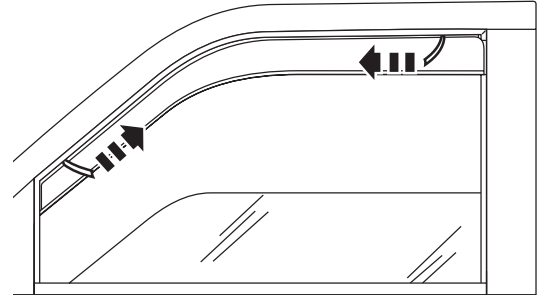

Apply pressure to all flange edges to ensure proper adhesion.

5

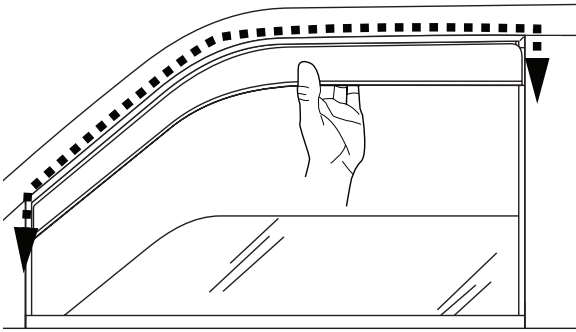

NOTE: It is necessary to both hold the visor up into the window channel **AND** pull the bottom of the visor slightly outward while raising the glass to seat visor properly.

6

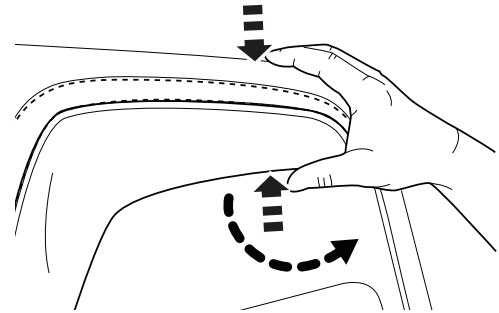

4 Piece Set

Install the rear visor using the same preparation and installation methods as front visor. Note that the top & rear flanges slide into the window channel, and the front flange fits between the rubber & window frame.

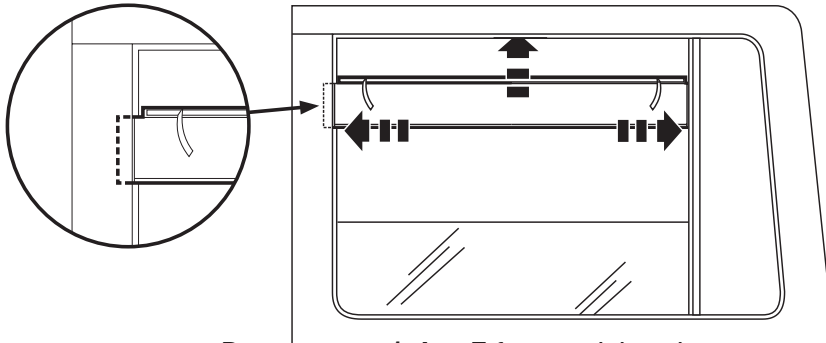

7

Repeat steps 1 thru 7 for remaining visors

Care and Cleaning

- Wash only with mild soap & dry with a clean cloth.

Congratulations!

You have purchased one of the many quality Lund[®] branded products offered by Lund International, Inc. We take the utmost pride in our products and want you to enjoy years of satisfaction from your investment. We have made every effort to ensure that your product is top quality in terms of fit, durability, finish and ease of installation.

LUND[®]



Check out the collection of rain guards and wind deflectors we offer.