

Installation Instructions

I - Sheet Number LUNDSR209

LUND[®]

Premium Style. Lasting Performance.

For proper installation and best possible fit, please read all instructions BEFORE you begin.

Care and Cleaning

- Wash only with mild soap and dry with a clean cloth.
- Every 3 months or 5000 miles check for loose hardware and tighten as necessary.

Congratulations!

You have purchased one of the many quality Lund[®] branded products offered by Lund International, Inc. We take the utmost pride in our products and want you to enjoy years of satisfaction from your investment. We have made every effort to ensure that your product is top quality in terms of fit, durability, finish and ease of installation.

SR2 RUNNING BOARD
09-17 DODGE RAM 1500 & 10-17 RAM 25-3500 CREW CAB

PARTS LIST:

2	SR2 Running Boards	24	8mm x 24mm x 2mm Flat Washers
1	Driver/left side Front Mounting Bracket	12	8mm Lock Washers
1	Passenger/right side Front Mounting Bracket	6	8-1.25mm Hex Nuts
2	Driver/left side Center/Rear Brackets	12	8-1.25mm Nylon Lock Nuts
2	Passenger/right side Center/Rear Brackets	12	6-1.0mm x 25mm Button Head Bolts
6	8mm Bolt/Nut Plates	24	6mm x 18mm x 1.6mm Flat Washers
6	8mm Double Bolt Plates	12	6-1.0mm Flange Nuts
6	8mm Plastic Retainers	1	Allen Wrench
12	8-1.25mm x 30 Hex Bolts		

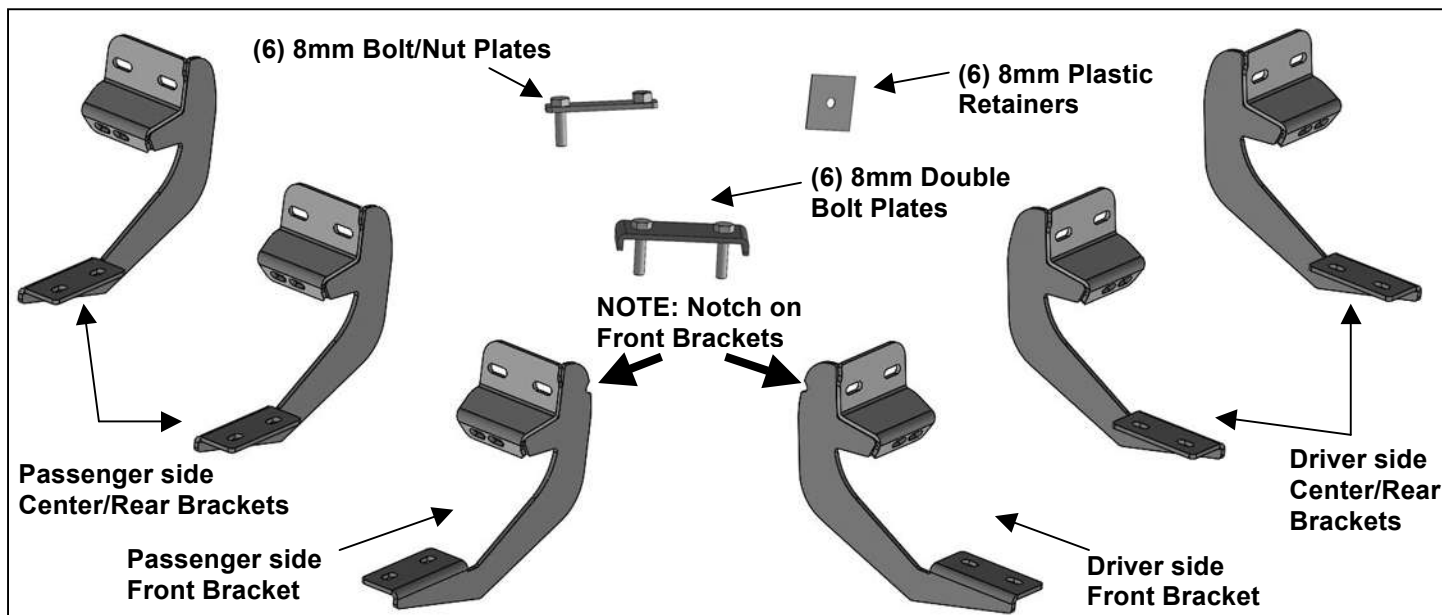

PROCEDURE:

1. REMOVE CONTENTS FROM BOX. VERIFY ALL PARTS ARE PRESENT. READ INSTRUCTIONS CAREFULLY BEFORE STARTING INSTALLATION. DRILLING MAY BE REQUIRED.
2. Starting at the passenger front side of the vehicle, remove the sealing tape covering the factory holes in the side of the inner panel, **(Figure 1)**.
3. Determine the correct procedure to attach the passenger side Front Bracket for your model/year:

Models without factory threaded inserts in body panel, (see Figure 1):

 - a. Select (1) 8mm Bolt-Nut Plate, **(Figure 2)**. Partially thread an 8mm Hex Bolt into the threaded nut on the Bolt-Nut Plate, **(Figure 3)**. Thread the Hex Bolt in until it is flush with the welded nut. Use the Hex Bolt as a handle and insert the Bolt-Nut Plate into the oval hole, **(Figure 4)**. Feed the threaded bolt on the Bolt-Nut Plate through one of the hex shaped factory holes.
 - b. Thread (1) 8mm Plastic Retainer onto the threaded end and down tight against the body panel, **(Figure 5)**. **NOTE:** The Plastic Retainer is designed to keep the Bolt-Nut Plate from falling into the body panel and to aid in Bracket installation.
 - c. Select the passenger side Front Bracket, **(Figure 6)**. Attach the Bracket to the threaded end of the Bolt Plate with (1) 8mm Flat Washer, (1) 8mm Lock Washer and (1) 8mm Hex Nut, **(Figure 7)**.
 - d. Remove the 8mm Hex Bolt from the nut on the Bolt Plate from **Step 3a**. Rotate the Bolt on the Bolt-Nut Plate until the threaded nut lines up with the remaining hole in the Bracket and hex hole in the body panel, **(Figure 7)**. Attach the Bracket to the threaded nut with (1) 8mm x 30mm Hex Bolt, (1) 8mm Lock Washer and (1) 8mm Flat Washer, **(Figure 7)**. Do not tighten hardware.

Models with factory threaded inserts, (see Figure 8):

 - a. Attach the passenger side Front Bracket to the threaded inserts with (2) 8mm x 30mm Hex Bolts, (2) 8mm Lock Washers and (2) 8mm Flat Washers, **(Figures 8 & 9)**. Leave hardware loose.

SR2 RUNNING BOARD

09-17 DODGE RAM 1500 & 10-17 RAM 25-3500 CREW CAB

4. Next, attach the Bracket to the back of the pinch weld with (2) 6mm Button Head Bolts, (4) 6mm Flat Washers and (2) 6mm Flange Nuts, (**Figures 10 & 11**). Do not fully tighten hardware at this time.
IMPORTANT: Most 2009-12 models are not equipped with factory holes and will require drilling through the pinch weld to attach the Bracket. Do not drill through pinch weld at this time, (**see Step 11**).
5. Move along the side of the body panel to the center mounting location, (**Figure 12**). Repeat the appropriate **Steps 2—4** to install the Passenger side Center Bracket, (**Figure 13**).
6. Move to the rear location, (**Figure 14**). Repeat the appropriate **Steps 2—4** to install the Passenger side Rear Bracket, (**Figure 15**).
7. Select (1) Running Board and (3) 8mm Double Bolt Plates, (**Figure 16**). Insert (3) 8mm Double Bolt Plates into the channels on the bottom of the Running Board, (**Figure 17**).
8. With assistance, carefully position the Running Board onto the (3) Mounting Brackets. Lift the Running Board up and slide the Double Bolt Plates along the channels to line up with the Brackets.
IMPORTANT: Do not slide the Running Board on the Brackets, (front to back or rotate), or the finish on the Running Board may be damaged.
9. Line up the front of the Running Board approximately 2" back, (or locate as desired), from the front wheel opening. Attach the Running Board to the Brackets with (6) 8mm Flat Washers and (6) 8mm Nylon Lock Nuts, (**Figures 18—21**). Do not tighten hardware at this time.
10. Properly level and adjust the Running Board and fully tighten all hardware.
2009-12 models requiring drilling to attach Brackets to pinch weld:
 - a. Level the Running Board to the vehicle. Make sure all (3) Brackets are tight against the bottom of the body panel and tighten all mounting hardware.
 - b. Mark the location of the slots onto the pinch weld.
 - c. Temporarily remove the Running Board and the (3) Mounting Brackets. Drill (2) 1/4" holes through the pinch weld for each Bracket. **IMPORTANT:** Do not drill too close to the bottom edge of the pinch weld. Drill the holes in the center of the marked slots.
 - d. Repeat **Step 4** to attach the Brackets to the drilled holes in the pinch weld. Check for level then fully tighten all hardware.
11. Repeat **Steps 2—10** for Running Board installation on the driver side.
12. Do periodic inspections to the installation to make sure that all hardware is secure and tight.

To protect your investment, wax this product after installing. Regular waxing is recommended to add a protective layer over the finish. Do not use any type of polish or wax that may contain abrasives that could damage the finish. Mild soap may be used to clean the Running Board.

Passenger Side Installation Pictured



SR2 RUNNING BOARD
09-17 DODGE RAM 1500 & 10-17 RAM 25-3500 CREW CAB
Passenger Side Installation Pictured

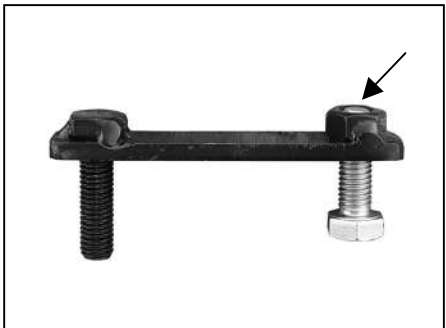

(Fig 3) Thread (1) 8mm Hex Bolt into the nut on the plate. Stop when bolt reaches end of nut as pictured

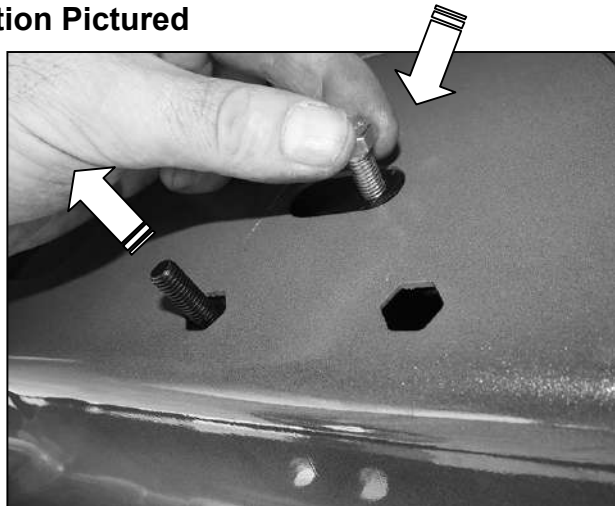

(Fig 4) Use the loose Hex Bolt as a handle. Insert the Bolt Plate into the oval hole and feed the threaded end out either factory hex shaped hole. IMPORTANT: Do not let go of the hex bolt until after Plastic Retainer has been threaded onto bolt (Fig 5)

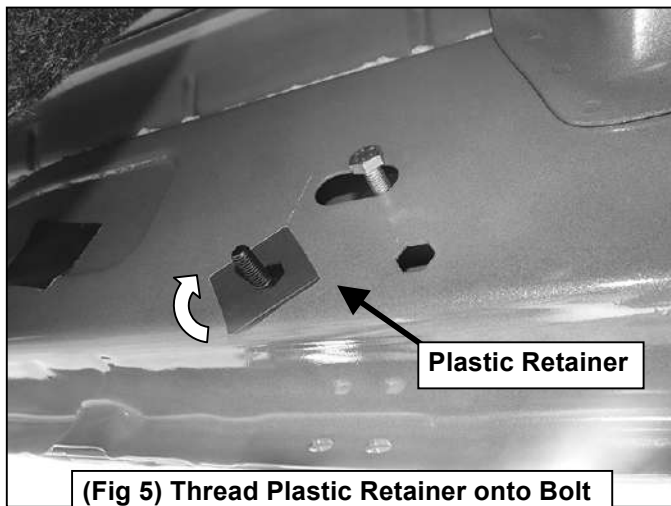

(Fig 5) Thread Plastic Retainer onto Bolt Plate to hold Bolt Plate in position.

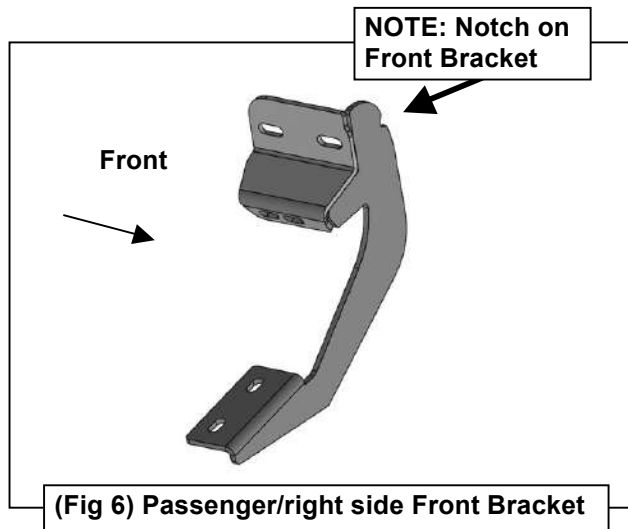

(Fig 6) Passenger/right side Front Bracket

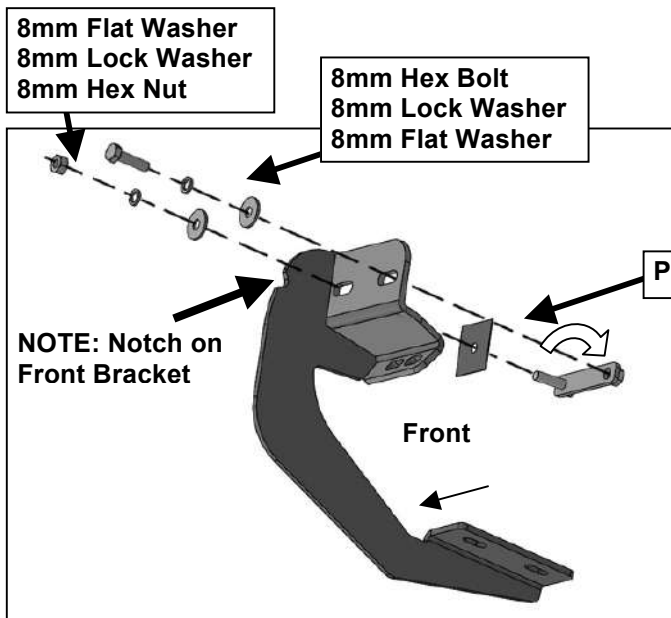

(Fig 7) Attach Bracket to threaded end of Bolt Plate first. Remove 8mm Hex Bolt (see Fig 3). Rotate Bolt Plate to line up with remaining factory hex shaped hole.

SR2 RUNNING BOARD
09-17 DODGE RAM 1500 & 10-17 RAM 25-3500 CREW CAB
Passenger Side Installation Pictured

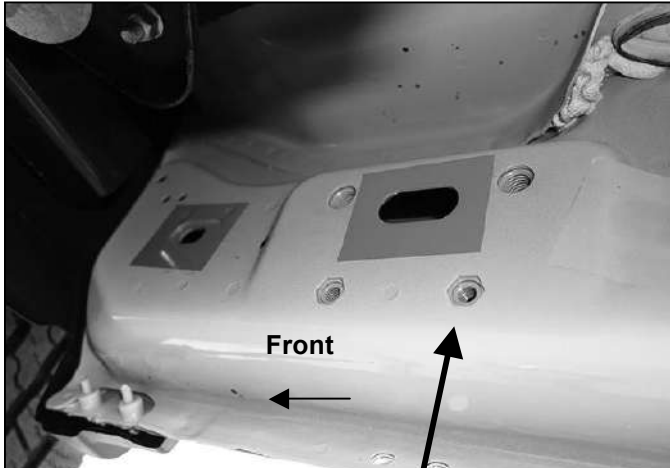

(Fig 8) Passenger side front mid 2015-on (example of models with factory installed threaded inserts)

IMPORTANT: 2009-2012 models without holes in pinch weld will require drilling 1/4" holes through pinch weld to attach the bracket. Do complete installation of Running Boards first, level Running Board before drilling holes for bracket.

- (2) 8mm Hex Bolts
- (2) 8mm Lock Washers
- (2) 8mm Flat Washers

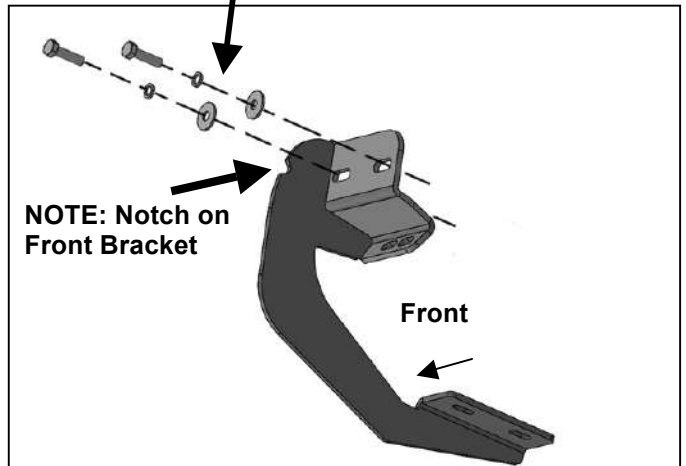

(Fig 9) Passenger side front models with factory installed threaded inserts. Bolt Plate not required

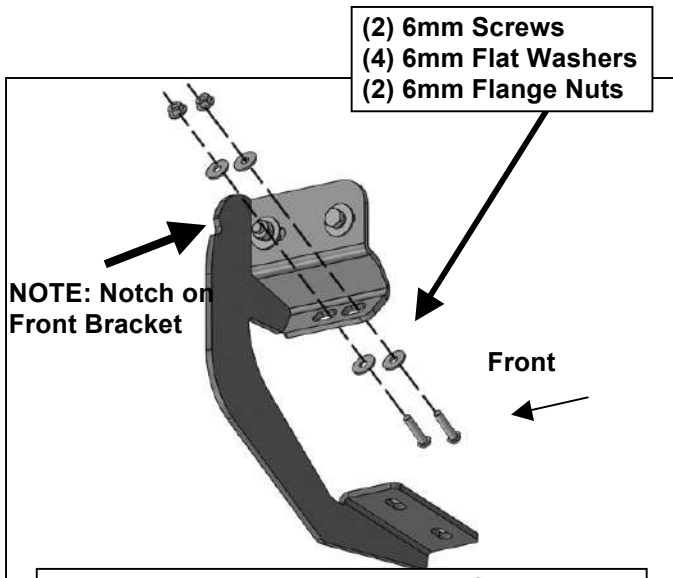

(Fig 10) Attach Bracket to back of pinch weld (models with factory holes in pinch weld only)

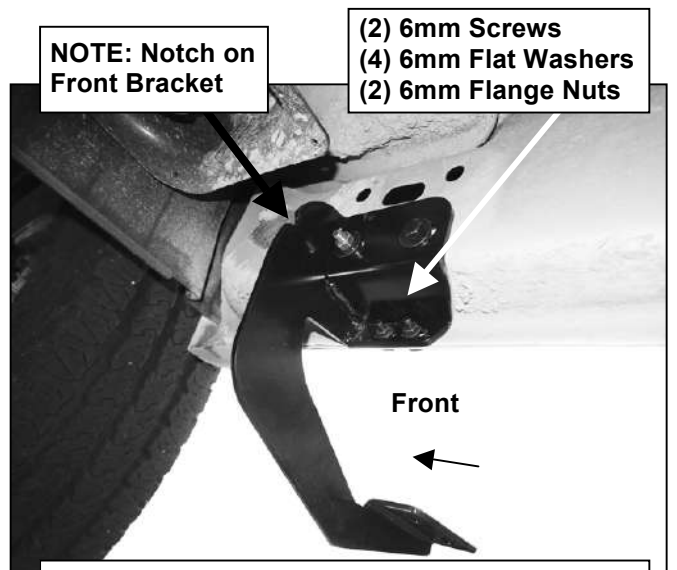

(Fig 11) Attach Bracket to back of pinch weld (models with factory holes in pinch weld only)

SR2 RUNNING BOARD
09-17 DODGE RAM 1500 & 10-17 RAM 25-3500 CREW CAB
Passenger Side Installation Pictured

IMPORTANT: 2009-2012 models without holes in pinch weld will require drilling 1/4" holes through pinch weld to attach the bracket. Do complete installation of Running Boards first, level Running Board before drilling holes for bracket.

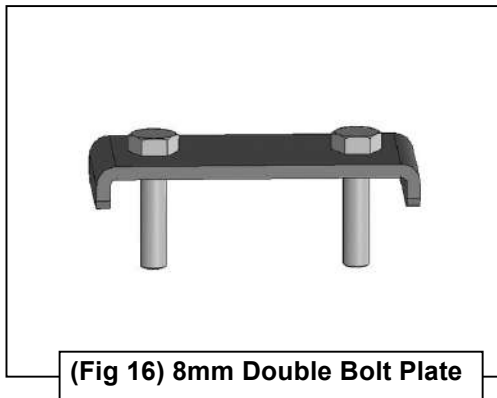
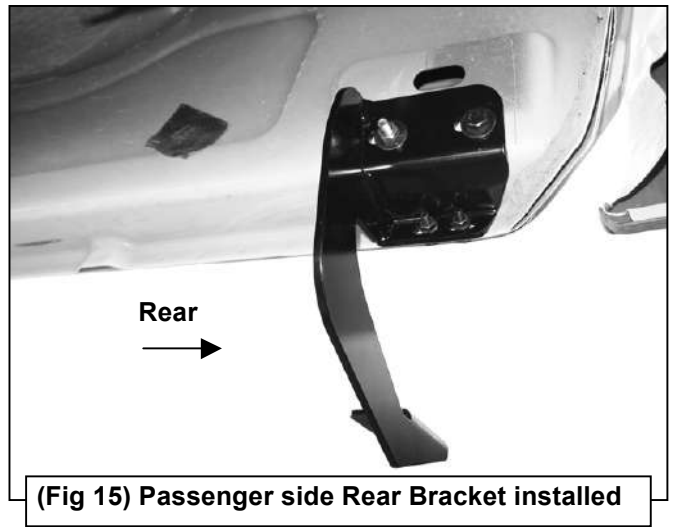
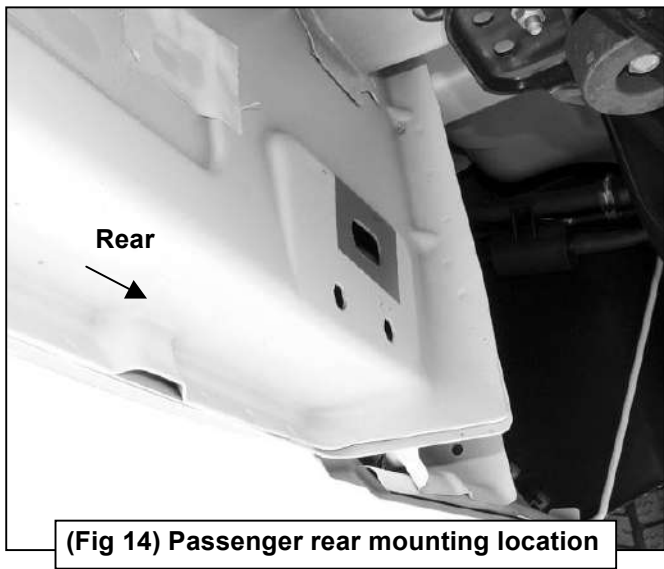
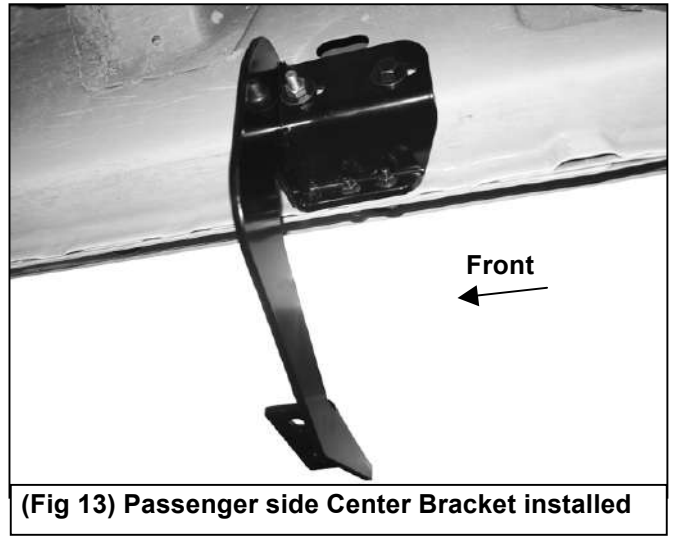
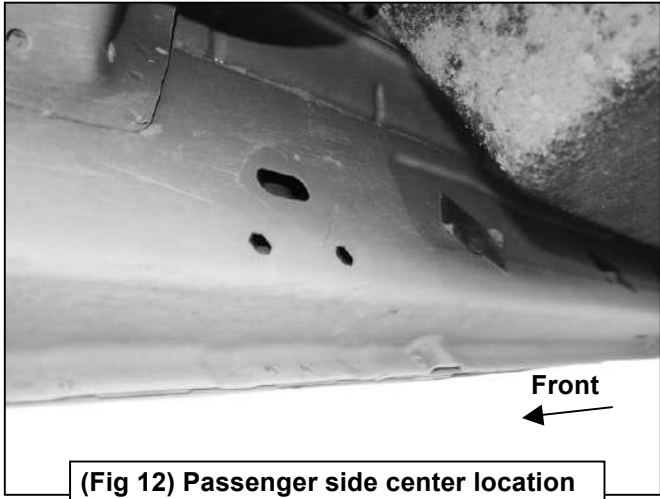

SR2 RUNNING BOARD
09-17 DODGE RAM 1500 & 10-17 RAM 25-3500 CREW CAB
Passenger Side Installation Pictured

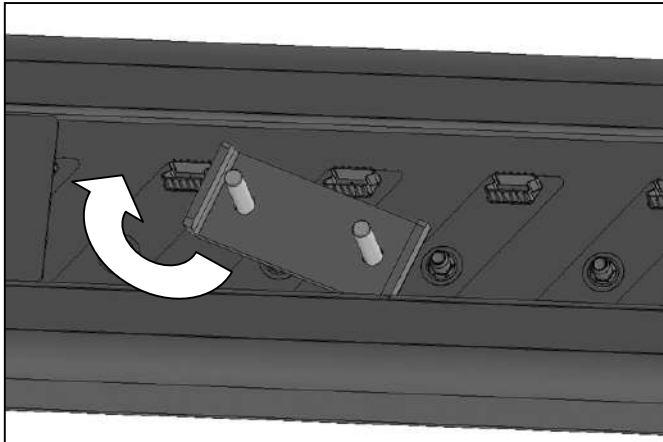

(Fig 17) Slide 8mm Double Bolt Plate into channel

NOTE: Notch on Front Bracket

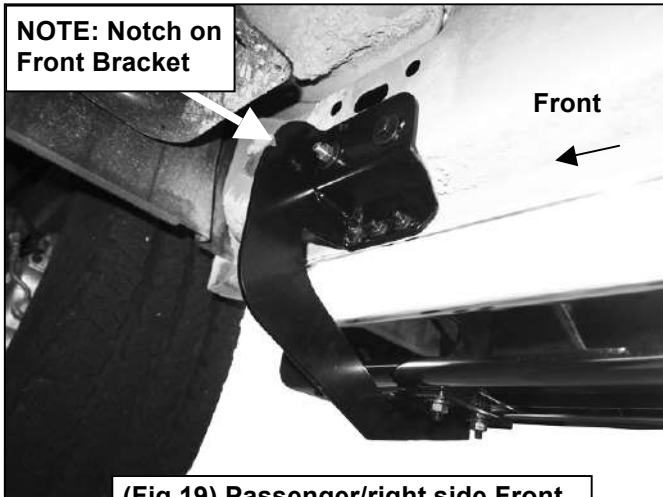

(Fig 19) Passenger/right side Front Bracket attached to Running Board

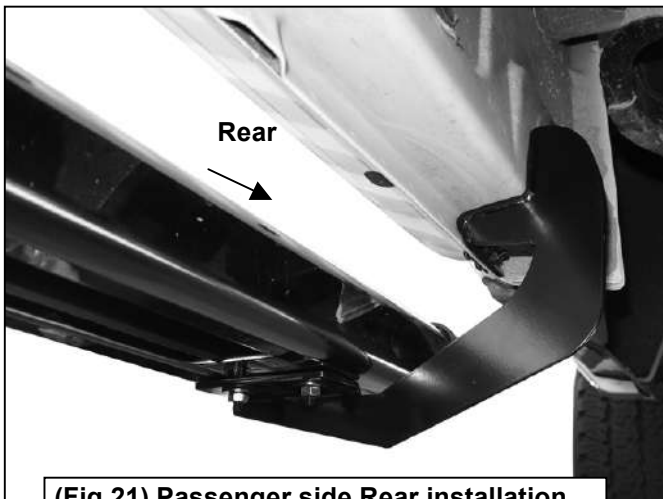

(Fig 21) Passenger side Rear installation

IMPORTANT: 2009-2012 models without holes in pinch weld will require drilling 1/4" holes through pinch weld to attach the bracket. Do complete installation of Running Boards first, level Running Board before drilling holes for bracket.

(2) 8mm Flat Washers
(2) 8mm Nylon Lock Nuts

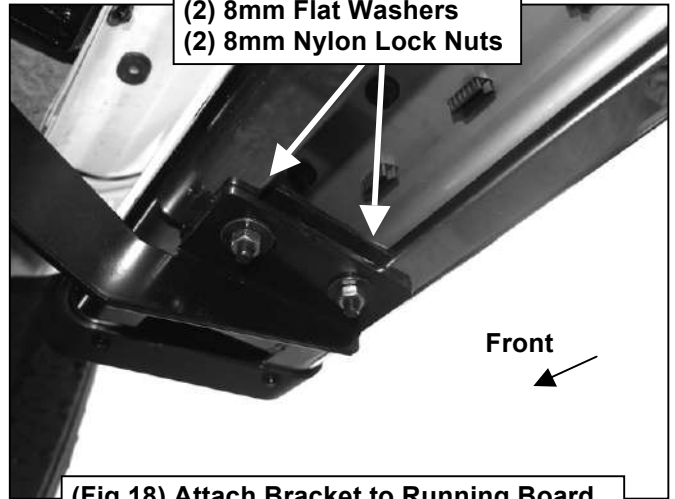

(Fig 18) Attach Bracket to Running Board

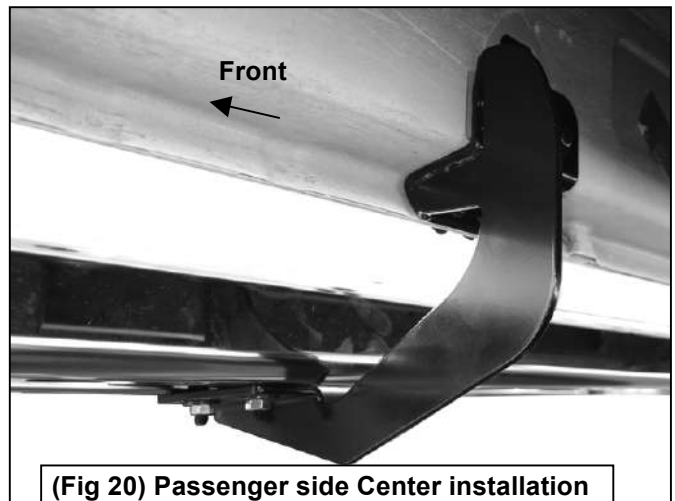

(Fig 20) Passenger side Center installation



Complete Installation