



Elite Series Fender Flares

For proper installation and best possible fit, please read all instructions BEFORE you begin.

Important Safety Information



- CAUTION - Before driving, ensure that the fender flare is properly secured to vehicle.
- Do not use automatic "brush-style" car washes.
- Do not use cleaning solvents of any kind.
- Periodically check all components for tightness.

Contents

NOTE: (Content shown below is for (4) piece installations. (2) Piece installations will contain smaller quantities.)



Driver side front

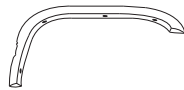

Passenger side front



Rubber Seal

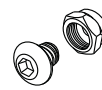

(RX Style only)
Rivet + Nylon Nut
x38



Push U-
Clip x12



Driver side rear



Passenger side rear

Tools Required

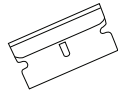

Razor Blade

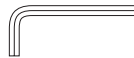

Hex Key 4.0 and 4.5

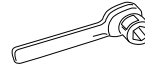

Socket Wrench

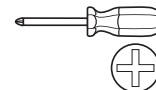

Phillips screwdriver

Preparation Before Painting / Installation

Custom Paint Job (Optional)

Please test fit all the flares first to ensure you have the correct flares for your vehicle. We are not responsible for any costs you may incur if you did not confirm the flares before having it painted. We recommend hiring professionals to custom paint the products. It is also ideal to have the painting done prior to the installation to eliminate any over-spraying issues.

Remove existing fender flares. (Skip this step if you don't have existing fender flares.)

Remove all the screws and fasteners currently holding the existing flare to the vehicle. Write down and save all the screws you have removed for re-use with the Lund fender flares. If certain areas of the existing flares are held on with double sided tape, you will have to pry your existing flare off. Please do so carefully to avoid damage to your vehicle body.

Test fitting.

Hold each and every flare up to the fender. Make sure you align the flare to the contour of the body, and the mounting holes lineup to the existing mounting holes on the inner fender lip (if applicable). Don't worry if not all the holes line up, as some holes are meant to be used with different installation hardware that is provided. The flares may not be sitting flush at this time, our flares are designed to flex into the bodyline when you actually install them using the provided and existing hardware. At any time, do not drill or modify the fender flare in anyway, as you will void your warranty.

Remove other existing parts.

Some vehicles may require the removal of existing parts that will interfere with the installation. Common item would be mud flaps; however by using fender flares, they act as another form of mud deflector. If you are not confident in doing so, this will be a good time to take your vehicle to a professional for the installation. Save existing screws and fasteners from the vehicle.

Cleaning the vehicle.

Make sure to wash your vehicle, especially the area the fender flares will be mounted to including the inner fender lip. Any dirt or debris that has not been cleaned or removed can potentially cause the improper fitment of the fender flare. If you are covering existing rust, we recommend sanding down the rust and primer over to prevent further deterioration of the metal in the fender. Make sure the vehicle is dry before the installation. The fender flares come ready to be installed, however if you need to clean them, please use a mild detergent to wash and then dry completely.

Preparation Before Painting / Installation

For RX Style Only (SKIP if you have SX or EX style)

Install the rivet screws and nuts to each of the rivet holes on the flare. Our rivets are designed to screw on to the fender flares only, and they shouldn't be touching the vehicle body at all. Using hand tools, tighten nuts until fastener is snug. **DO NOT OVERTIGHTEN** as this may damage the fender flare.

Installation of the Rubber Seal

Before you start cutting any rubber seal, please study the diagram. Do not use the rubber seal in any other areas other than indicated; otherwise you will end up with a shortage of rubber seal on your last flare. Start the installation of the rubber seal as indicated in the diagram. Then cut the rubber seal with a razor. Follow the same instruction for the remaining flares.

*Each roll of the rubber seal provided is long enough to complete the 4 fender flares and with extra to spare, however we are not responsible for the improper use of the rubber seal. Contact Lund International to purchase additional rolls of rubber seal.

Installation Steps **NOTE:** Actual application may vary slightly from illustrations.

1. Start with any fender flare you like. If parts have protective film applied, please remove it now. First, holding the flare against the fender. Make sure that all the body line is lined up, and insert the first mounting hardware towards the middle of the flare. That way it will hold up the flare.
2. Next, you will continue the installation of all the remaining hardware from the middle outwards. Before tightening any hardware, make sure the flare is lined up correctly.

TIP: it may be a good idea to line up all the necessary hardware in order on the floor next to the wheel so you will have easy access to them, which will help avoid any confusion and mistakes.

3. Finally, you will tighten the hardware fasteners if needed. If it's a clip type, make sure the clips are clipped into place. (refer to the diagram for correct way to mount the hardware)
4. Now you can try to use your hand and lightly pry on the flare at the mounting location to see if any hardware is loose.
5. Repeat the same steps for rest of the flares.

Front Flare

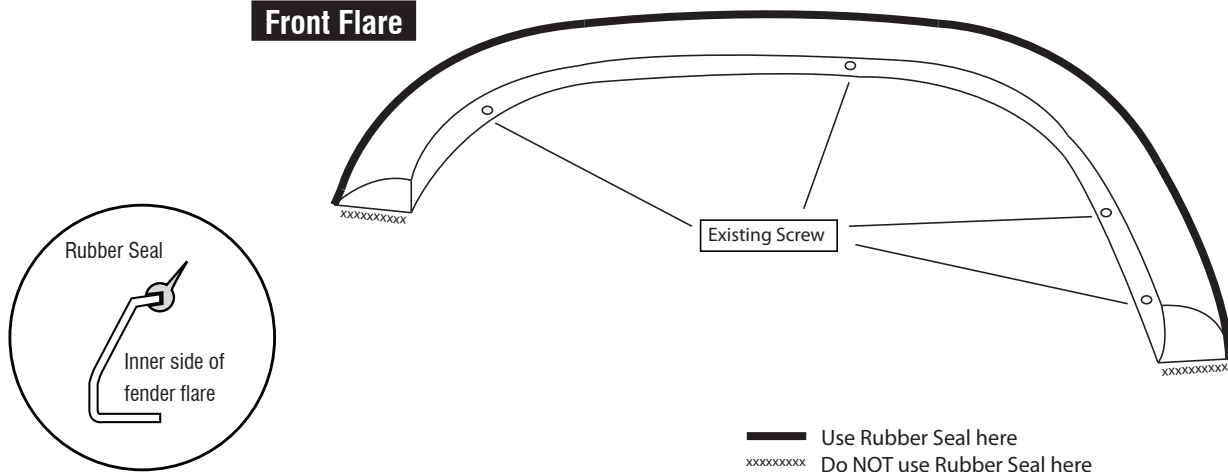

Rear Flare

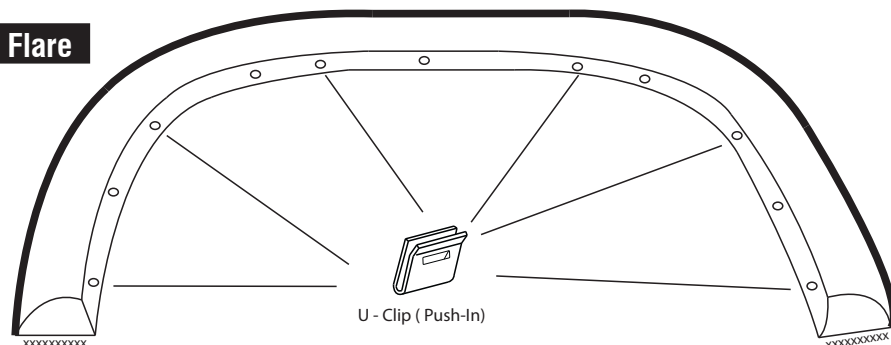

Installation Steps **NOTE:** Actual application may vary slightly from illustrations.

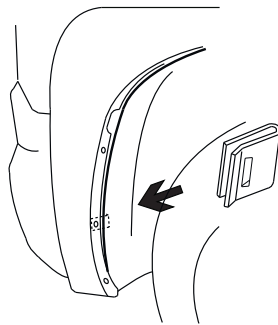

Push U-Clip

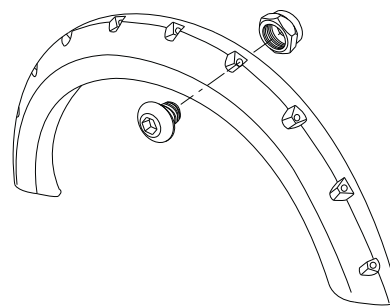
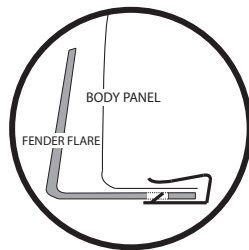

For Rivet Style

Care and Cleaning

- Lund fender flares are built to last; any detergent you use to wash your vehicle is sufficient to clean the flares. Do not use any harsh abrasive detergents.

PLEASE READ: Dirt and debris can become lodged between the fender flares and the vehicle's fenders, causing scratching and paint wear from vibration. Lund International is not responsible for any damage, and the installation of our fender flares is done with the buyer's understanding that this scratching and paint wear may occur.

Congratulations!

You have purchased one of the many quality Lund[®] branded products offered by Lund International, Inc. We take the utmost pride in our products and want you to enjoy years of satisfaction from your investment. We have made every effort to ensure that your product is top quality in terms of fit, durability, finish and ease of installation.



LUND[®]

LUND[®]
INTERNATIONAL