

LOWRANCE

HOOK Series

Operation manual

ENGLISH



HOOK-4



HOOK-5



HOOK-7

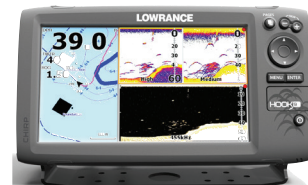

HOOK-9

Lowrance® and Navico® are registered trademarks of Navico.

Fishing Hot Spots® is a registered trademark of Fishing Hot Spots Inc.

Navionics® is a registered trademark of Navionics, Inc.

Navico may find it necessary to change or end our policies, regulations and special offers at any time. We reserve the right to do so without notice. All features and specifications subject to change without notice.

Compliance Statements

Lowrance HOOK-4, HOOK-5, HOOK-7 and HOOK-9

- meets the technical standards in accordance with Part 15.103 of the FCC rules
- complies with CE under RTTE directive 1999/5/EC
- complies with the requirements of level 2 devices of the Radiocommunications (Electromagnetic Compatibility) standard 2008

Warning

The user is cautioned that any changes or modifications not expressly approved by the party responsible for compliance could void the user's authority to operate the equipment. This equipment has been tested and found to comply with the limits for a Class B digital device, pursuant to Part 15 of the FCC rules. These limits are designed to provide reasonable protection against harmful interference in a residential installation. This equipment generates, uses and can radiate radio frequency energy and, if not installed and used in accordance with the instructions, may cause harmful interference to radio communications. However, there is no guarantee that the interference will not occur in a particular installation. If this equipment does cause harmful interference to radio or television reception, which can be determined by turning the equipment off and on, the user is encouraged to try to correct the interference by one or more of the following measures:

- Reorient or relocate the receiving antenna
- Increase the separation between the equipment and receiver
- Connect the equipment into an outlet on a circuit different from that of the receiver
- Consult the dealer or an experienced technician for help



WARNING: When a GPS unit is used in a vehicle, the vehicle operator is solely responsible for operating the vehicle in a safe manner. Vehicle operators must maintain full surveillance of all pertinent driving or boating conditions at all times. An accident or collision resulting in damage to property, personal injury or death could occur if the operator of a GPS-equipped vehicle fails to pay full attention to travel conditions and vehicle operation while the vehicle is in motion.



NOTE: This manual covers HOOK-4, HOOK-5, HOOK-7 and HOOK-9 units. As a result, screenshots of menus and dialogs may not match the look of your unit.







Table of contents

| | |
|-------------------------------|----------|
| Introduction..... | 6 |
| Unit controls..... | 6 |
| Inserting microSD cards | 7 |
| Basic operation..... | 8 |
| Setup wizard..... | 8 |
| Pages | 8 |
| Selecting pages..... | 8 |
| Page menus | 8 |
| Working with menus | 10 |
| Dialogs..... | 10 |
| Entering text | 11 |
| Fishing modes | 11 |
| Cursor..... | 12 |
| Goto cursor..... | 12 |
| Advanced mode | 13 |
| Standby mode | 13 |
| Restore defaults | 13 |

| | |
|------------------------------|-----------|
| Pages | 14 |
| Steer page | 14 |
| Sonar page..... | 14 |
| Downscan page | 15 |
| Chart page..... | 15 |
| Combo pages | 16 |
| Overlay data | 17 |
| Sonar operation | 18 |
| CHIRP | 18 |
| Trackback | 19 |
| Sonar menu | 19 |
| Sonar options | 23 |
| Downscan options | 24 |
| Sonar settings..... | 25 |
| Installation | 27 |

| | | | |
|--------------------------------------|-----------|-----------------------------|-----------|
| DownScan operation..... | 28 | Settings | 48 |
| Trackback | 28 | Settings menu..... | 48 |
| DownScan menu | 28 | System..... | 48 |
| Ping speed..... | 30 | Alarms | 50 |
| Downscan options | 30 | Saving screenshots | 50 |
| Chart operation..... | 33 | Specifications | 52 |
| Chart menu..... | 33 | Index | 56 |
| Waypoints, Routes, Trails | 34 | | |
| Routes screen | 35 | | |
| Trails screen | 39 | | |
| Orientation | 41 | | |
| Chart settings | 42 | | |
| Navigation settings | 43 | | |
| AIS..... | 45 | | |
| AIS setup..... | 45 | | |
| Target symbols | 46 | | |
| Viewing AIS target information | 47 | | |

Introduction

| Unit controls | |
|--|--|
|  | LIGHT/POWER: controls backlight level and turns unit on/off |
|  | KEYPAD: controls cursor & selects items on menus |
|  | PAGES: allows you to select a page to view |
|  | MENU: opens settings, context and page menus |
|  | ENTER: finalizes menu selections; save waypoint at cursor position |
|  | MOB: press and hold both Zoom keys to create a Man Overboard waypoint |
|  | ZOOM Keys: used to zoom in/zoom out |
| microSD slot: insert a blank microSD card to save screen captures; or insert a microSD mapping card to use mapping data | |

| Getting started | |
|--------------------------------|---|
| Turn unit on/off | To turn on/off the unit, press and hold the LIGHT/POWER key for three seconds. |
| Man Overboard waypoint | Press the ZOOM IN and ZOOM OUT keys at the same time to set a Man Overboard waypoint. Your system will automatically create an active route back to the MOB waypoint. You must cancel navigation to terminate the function. |
| Adjusting the backlight | This unit has 10 backlight levels. Press the LIGHT/POWER key to switch backlight levels. |
| Muting Audio | Select Audio from the System menu and press ENTER . Enable/disable <i>Mute</i> . |

Inserting microSD cards

Carefully slide the microSD card into the slot until it clicks into place. To remove, carefully push in the card until it clicks out of place.

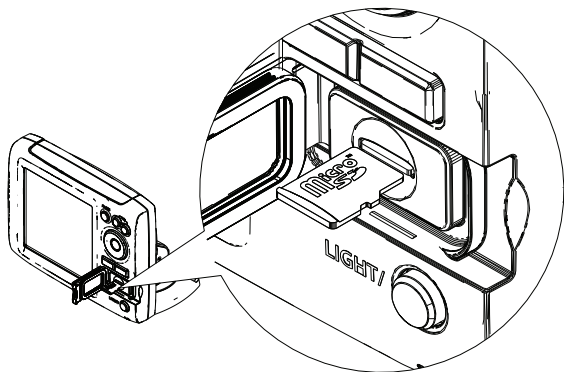

HOOK-5, HOOK-7 and HOOK-9

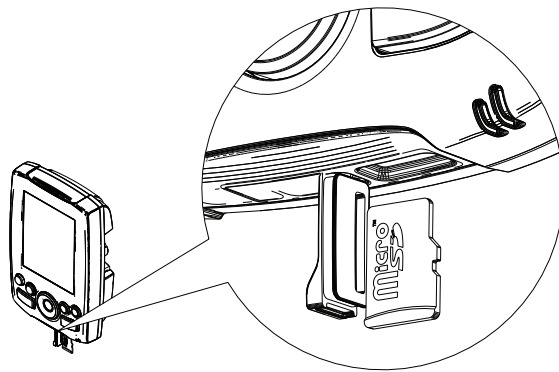

HOOK-4

Basic operation

Setup wizard

The Setup wizard will appear when the unit is turned on for the first time. To choose your own settings, do not run the setup wizard. To restart the Setup wizard, restore defaults.

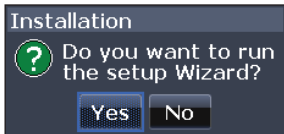

Pages

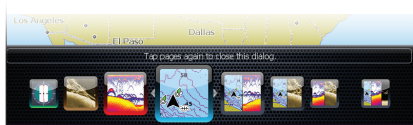

Pages dialog



NOTE: Available pages vary depending on the unit and the connected transducer.

Selecting pages

To select a page, press the keypad in the direction of the desired page and press **ENTER**.

Page menus

The Steer, Downscan, Sonar and Chart pages have menus that can only be accessed when those pages are displayed.

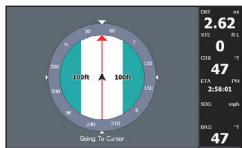

Steer page

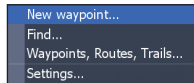

Steer menu

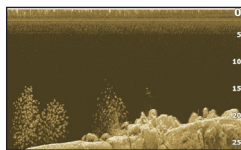

Downscan page

MENU

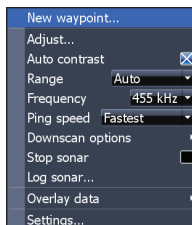

Downscan menu

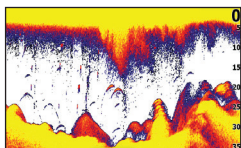

Sonar page

MENU

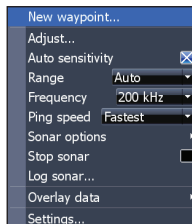

Sonar menu

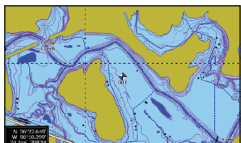

Chart page

MENU

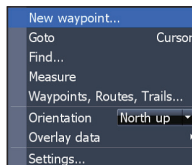
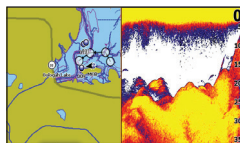
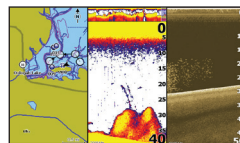

Chart menu

Combo pages



Two-panel page



Three-panel page

Press the **PAGES** key twice to switch active panels. The page menu for active page will be displayed when the **MENU** key is pressed. The active panel is denoted by an orange border.

Accessing the Settings menu

MENU

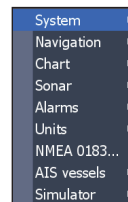

Accessing menu items

The keypad and **ENTER** key are used to select menu items and open submenus. Use the keypad to highlight the desired item and press **ENTER**.

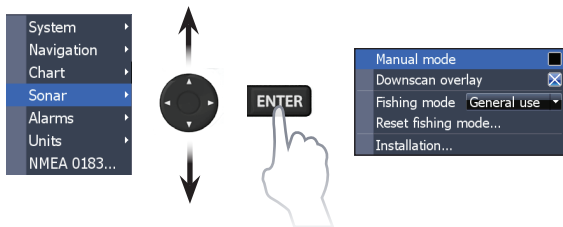

Working with menus

There are several menu types used to make adjustments to options and settings, including scrollbars, on/off features and dropdown menus.

Scrollbars

Select the scrollbar and press the keypad left (decrease) or right (increase).

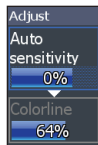

On/Off features

Select an on/off menu item and press **ENTER** to turn it on/off.

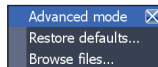

Dropdown menus

Access the dropdown menu and press the keypad up/down to select the desired item and press **ENTER**.

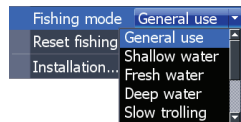

NOTE: Press the **MENU** key to Exit menus.

Dialogs

Dialogs are used for user input or for presenting information to the user. Depending on the type of entry, different methods are used to confirm, cancel or close the dialog.

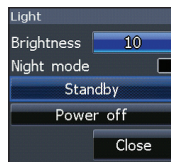

Entering text

Some functions, like naming a waypoint, route or trail, will require you to input text.

To input text:

1. Use the keypad to select the desired character and press **ENTER**.
2. Repeat Step 1 for each character.
3. When entry is completed, highlight **OK** and press **ENTER**.

Switches letters to uppercase/
lowercase

Switches keyboard between Alpha and
QWERTY layout

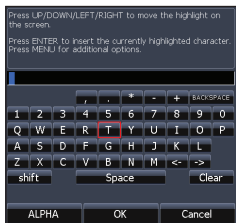

Fishing modes

(Conventional sonar only)

Fishing modes enhance the performance of your unit by providing preset packages of sonar settings geared to specific fishing conditions.

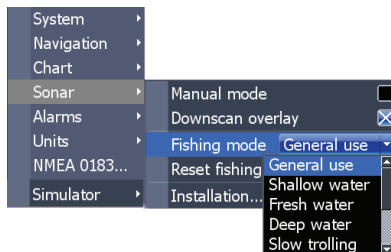

| Fishing mode options | | |
|----------------------|-----------------|-----------------------|
| General Use | 1000 ft or less | Coastal |
| Shallow Water | 60 ft or less | Shallow weedy bottoms |
| Fresh Water | 400 ft or less | Inland/Near coastal |
| Deep Water | 1000 ft or more | Offshore |
| Slow Trolling | 400 ft or less | Inland/Coastal |
| Fast Trolling | 400 ft or less | Inland/Coastal |
| Clear Water | 400 ft or less | Inland/Coastal |
| Brackish Water | 400 ft or less | Fresh-Saltwater mix |
| Ice | 400 ft or less | Ice fishing |



NOTE: Use Fresh Water mode when fishing in less than 100 feet of water; otherwise your unit may not track bottom properly.

Cursor

The keypad moves the cursor around the display, allowing you to scroll the map, select map items and review sonar history.

Press **MENU** and select *Return to vessel* or *Exit cursor mode* to clear the cursor.

Goto cursor

Used to navigate to the cursor.

1. Move the cursor to a desired location and press **MENU**.
2. Select *Goto cursor* and press **ENTER**.

Advanced mode

Enables advanced features and settings.

The following features are enabled when Advanced mode is turned on:

- Navigation (Enables arrival radius, off-course distance and Bearings setting)
- Alarms (Enables arrival, off course and anchor alarm options)
- NMEA 0183 Output (Requires optional Power/NMEA cable 000-0127-49)
- Units (Enables distance, speed, depth, temperature, and bearings options)

Standby mode

Lowens power consumption by turning off sonar and the display.



Press the **PWR/LIGHT** key to access the Backlight dialog.



NOTE: *Leaving your unit in Standby mode when your boat is not in use will run down your battery.*

Restore defaults

Resets unit options and settings to defaults.

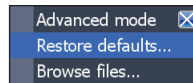

Pages

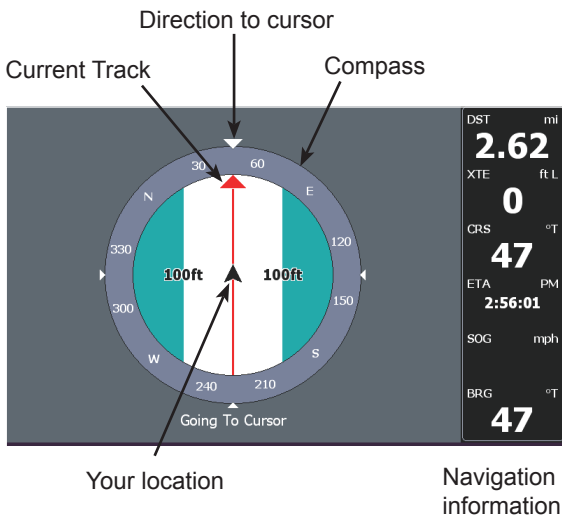

Steer page

The Steer page has a compass that shows your current track, the direction to your destination, and a digital data navigation panel.

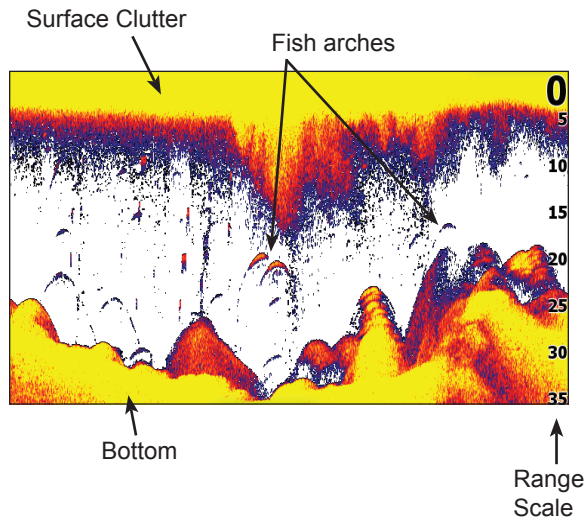

Sonar page

Displays the water column moving from right to left on your unit's screen.

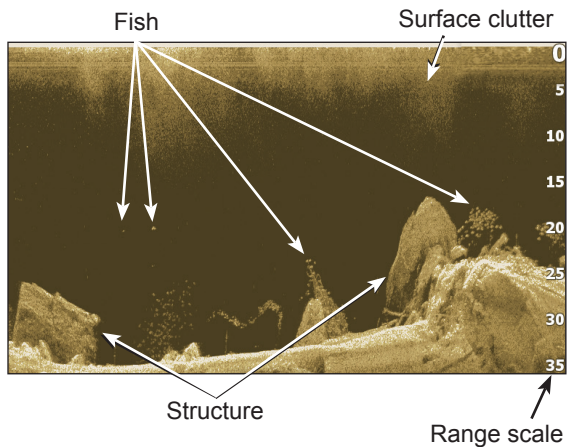

Downscan page

The Downscan page shows the water column moving from right to left. You can overlay downscan sonar on the conventional sonar page by selecting **Downscan Overlay** on the Sonar settings menu.

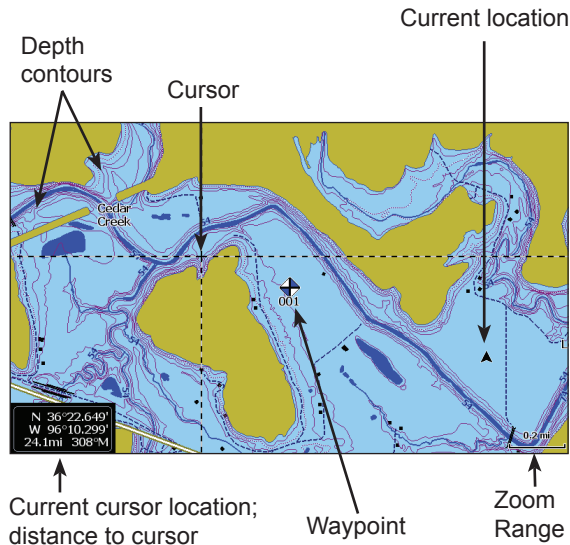
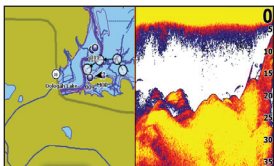

Chart page

Consists of map that moves in real-time as you move. By default, the map is shown from a bird's-eye view with North at the top of the screen.

Combo pages

This unit has four pre-configured combo pages.



Chart/Sonar

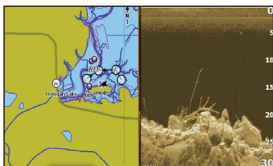

Chart/Downscan

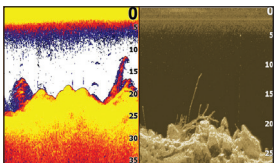

Sonar/Downscan

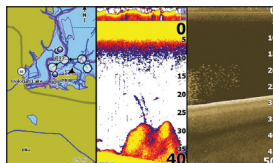

Chart/Sonar/Downscan



NOTE: Press the **PAGES** key twice to switch active panels.

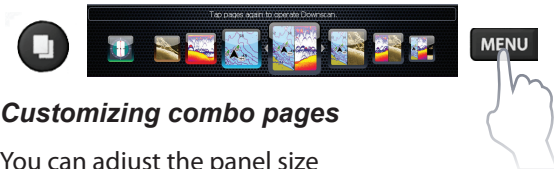

Customizing combo pages

You can adjust the panel size of combo pages and control how the pages will be arranged on the screen: vertically (side) or horizontally (over).

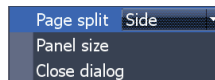

To make adjustments to combo page panels, select a combo page from the Pages carousel and press **MENU**.



NOTE: To adjust panel size, access the customize menu after selecting a combo page for display and select Panel size.

Overlay data

Used to select data shown on the Sonar, Structure and Chart pages.

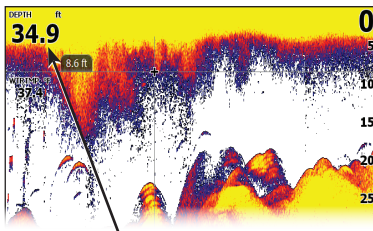

Overlay data

Show

Enables/disables the display of overlay data, allowing you to remove overlay data from the screen without deleting the current overlay data configuration.

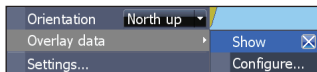

Configure

Allows you to select/customize overlay data.

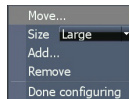

To add overlay data:

1. From the Sonar, Chart or DownScan page, press **MENU**.
2. Select *Overlay data* and press **ENTER**.
3. Select *Configure* and press **ENTER**.
4. Press **MENU** and select *Add*. Press **ENTER**.
5. Select a data category and press **ENTER**.
6. Select the desired data and press **ENTER**.
7. Press **MENU** and select *Return to Overlays*. Press **ENTER**.
8. Press **MENU**, select *Done Configuring* and press **ENTER**.

Sonar operation

This unit supports two types of sonar:
Conventional and Downscan.

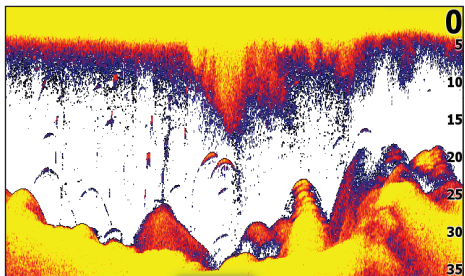

The features described in this section are for conventional sonar. Refer to the Downscan section for information on Downscan features.

CHIRP

A CHIRP (Compressed High Intensity Radar Pulse) transducer transmits a modulated pulse of multiple frequencies within the bandwidth

of the selected transducer type. This results in better image quality, better target separation and greater depth penetration.

This unit supports High CHIRP, Medium CHIRP and Low CHIRP, depending on the transducer.

CHIRP can be used with Lowrance conventional sonar transducers.

- 50/200 kHz (Low/High CHIRP)
- 83/200 kHz (Medium/High CHIRP)

To use CHIRP, select the desired CHIRP frequency from the Frequency menu.

Trackback

You can review your recent sonar history by moving the cursor to the left until the screen starts to move in reverse.

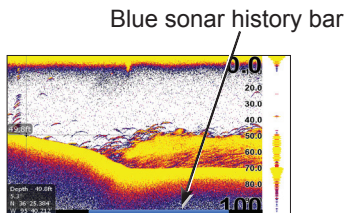

Move the sonar history bar all the way to the right to resume normal sonar scrolling, or press **MENU** and select *Exit cursor mode*.

Sonar menu

Press **MENU** from any sonar page to access the Sonar menu.

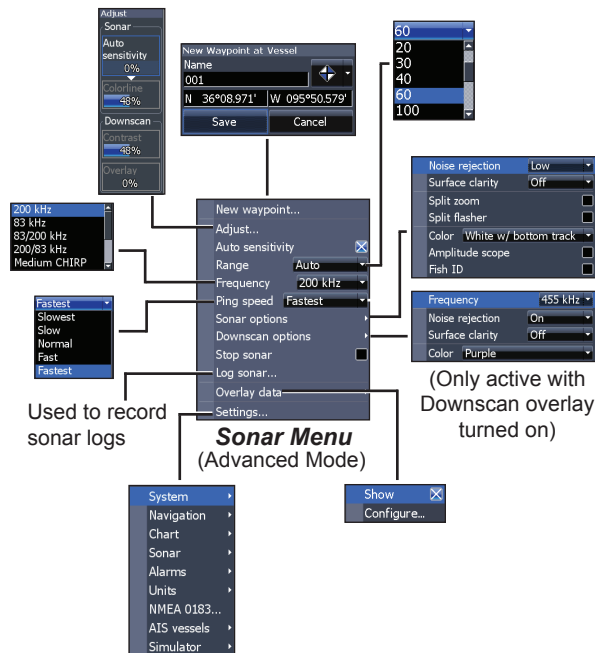
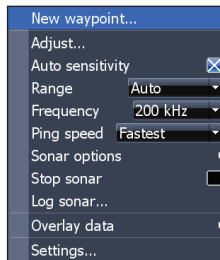

New waypoint

Places a waypoint at your current position or at the cursor position. From the new waypoint dialog, you can input a waypoint name, select an icon and input a desired latitude/longitude.

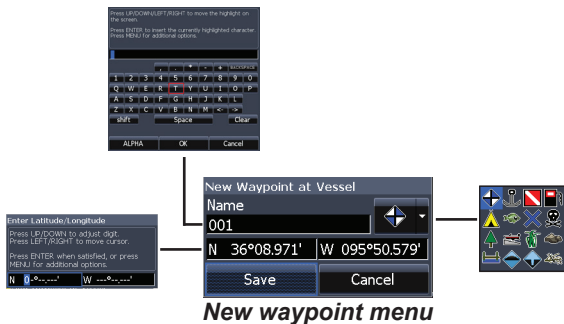

Adjust

Used to make adjustments to Sensitivity and Colorline.

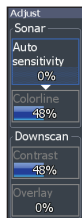

Sensitivity

Controls the level of detail shown on the display. Too much detail will clutter the screen. If Sensitivity is set too low, desired echoes may not be displayed.

Colorline

Helps distinguish fish or structure from the bottom by showing hard returns as light colors and soft returns as darker colors. A lower colorline setting will display only the hardest returns, shown in light colors.

Auto sensitivity

Keeps sensitivity at a level that works well under most conditions, reducing the needs for adjustments. Auto Sensitivity is turned on by default.



NOTE: You can make minor (+/-40%) changes to sensitivity with Auto Sensitivity turned on. You will have to turn it off to make significant adjustments.

Range

Selects the deepest range shown on the display. Range settings display the section of the water column from the water surface to the selected depth range.

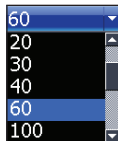

If you select too shallow a depth range, the unit will not be able to lock onto the bottom.

Custom range — Upper and Lower limits

Used to select the upper limit and lower limit of a section of the water column. That allows you to view a section of the water column that does not include the water surface or the bottom. Upper and lower limits must be at least 6.5 ft (2 m) apart.

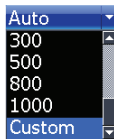

ENTER



Custom range menu



NOTE: When using a custom range, you may not receive any digital depth readings, or you may receive incorrect depth information.

Frequency

Controls the transducer frequency used by the unit. This unit supports conventional, CHIRP and DownScan sonar frequencies.

Only frequencies supported by your transducer will appear on the Frequency menu.



| Sonar frequencies | |
|-------------------|---|
| 50 kHz | Best depth penetration with lower resolution |
| 83 kHz | Wider cone angle provides more bottom coverage and easy lure tracking |
| 200 kHz | Highest sensitivity and best target separation in shallow water |
| Low CHIRP | Provides the best depth penetration with lower resolution images |
| Medium CHIRP | Better depth penetration than High CHIRP with minimal loss of target separation |
| High CHIRP | Better resolution in shallow water than Medium CHIRP |

| | |
|---------------|---|
| Custom high | Selects a custom single frequency from within High or Low frequency ranges to help reduce/eliminate interference from other CHIRP transducers |
| Custom medium | |

Ping speed

Controls the rate the transducer uses to send sonar waves into the water.

Ping speed adjustments can help reduce interference from other transducers. When using fishing modes, ping speed settings are optimized for the selected fishing conditions, so in most cases, adjustments are not necessary.

Sonar options

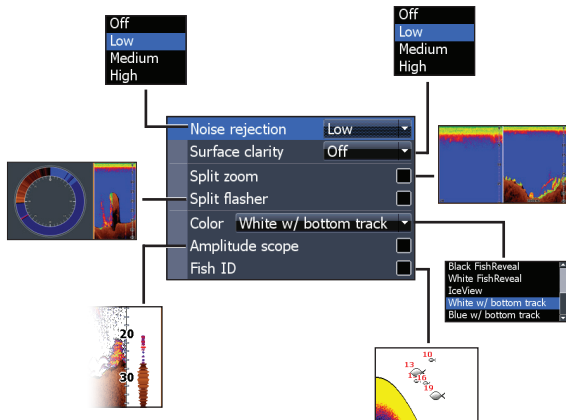

Noise rejection

Uses advanced signal processing to monitor the effects noise (boat pumps, water conditions, engine ignition systems, etc.) has on your display, and then filters out undesired signals.

Surface clarity

Surface Clarity reduces surface clutter by decreasing the sensitivity of the receiver near the surface.

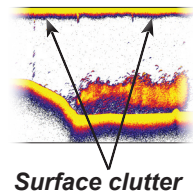

Split zoom and Split flasher

Switches the sonar display from full screen sonar to a split screen view.

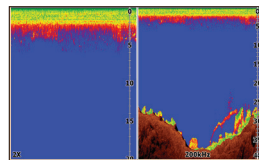

Split zoom

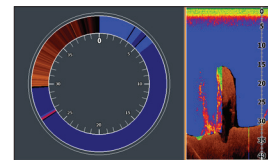

Split flasher

Color

Allows you to change the look of the display using palettes with varying degrees of color/brightness.

Amplitude scope

Displays the amplitude of the most recent echo.

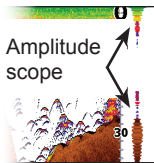

Fish ID

Displays fish echoes as fish symbols instead of fish arches.

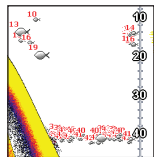

NOTE: *Fish ID is not the most accurate method of fish detection since structure and suspended debris may be shown as a fish symbol on the display.*

Downscan options

You can make adjustments to Downscan overlay settings from the sonar page. Downscan options are covered in more detail in the DSI section.

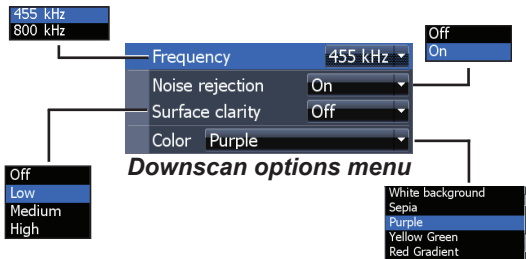

NOTE: *The Downscan options menu will only be available when Downscan overlay is enabled.*

Stop sonar

Prevents the transducer from transmitting to reduce/eliminate interference between two sonar units running on the boat at the same time.



NOTE: *Sonar history will not be recorded when sonar is stopped.*

Logging sonar

You can record sonar data and save the file on a microSD card inserted into the unit's card reader.

Controls the quality of sonar logs. Higher quality logs will use more memory.

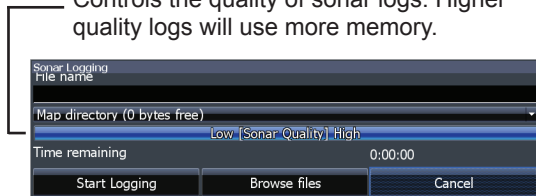

View previously saved sonar logs

Overlay data

Allows you to select data to be displayed on top of the Sonar page. Overlay data setup is covered in the Pages section.

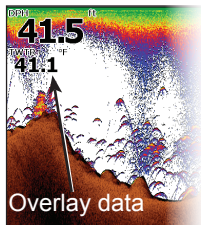

Sonar settings

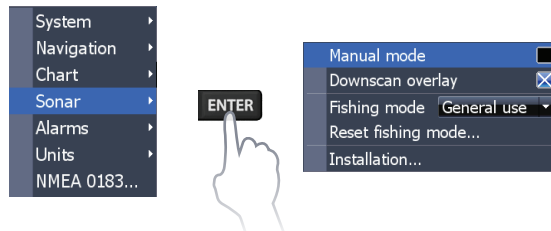

Conventional settings/Downscan settings

You can adjust settings for both Conventional sonar and Downscan sonar modes from the Sonar Settings menu.

Only adjustments made to conventional sonar settings will be visible on the sonar page.

Restricts unit's digital depth search capability

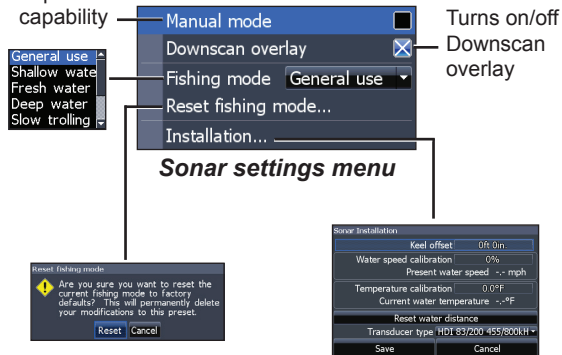

Turns on/off Downscan overlay

When the unit is in manual mode, you may not receive any depth readings, or you may receive incorrect depth information.

Fishing mode

Enhances the performance of your unit by providing preset packages of sonar settings geared to specific fishing conditions. For more information about fishing modes, refer to the Basic Operation section.

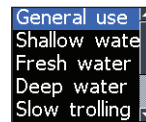

Manual mode

Restricts digital depth capability, so the unit will only send sonar signals to the selected depth range. That allows the display to continue smooth scrolling if the bottom depth is out of transducer range.



WARNING: Manual mode should only be used by advanced sonar users.

Reset fishing mode

Resets selected fishing mode to default settings. That is useful when you want to clear settings adjustments made while using a fishing mode.

Installation

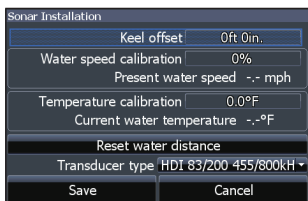

Installation menu

Keel offset

All transducers measure water depth from the transducer to the bottom. As a result, water depth readings do not account for the distance from the transducer to the keel/bottom of motor or from the transducer to the water surface.

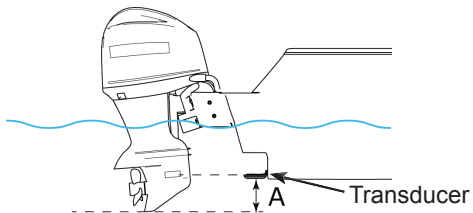

A: Keel offset (e.g. -1 foot)

Before setting keel offset, measure the distance from the transducer to the bottom of the motor - see illustration. If, for example, the distance is 1 foot, it will be input as (minus) -1 foot.

Water speed calibration

Calibrates a paddlewheel speed sensor with speed data from a GPS source.

Temperature calibration

Calibrates data from the transducer temperature sensor with data from a known temperature source to ensure the accuracy of temperature information.

Reset water distance

Reset Water Distance to zero.

Transducer type

Selects the type of transducer model attached to your unit.

DownScan operation

Features described in this section are for DownScan sonar. Refer to the Sonar operation section for information on conventional and CHIRP sonar.

Trackback

You can review your sonar history by pressing the keypad to the left until the screen starts to move in reverse and the sonar history bar appears at the bottom of the screen.

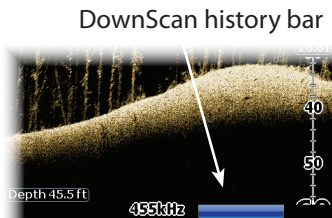

Move the sonar history bar all the way to the right to resume normal sonar scrolling, or press **MENU** and select *Exit cursor mode*.

DownScan menu

Press **MENU** from the DownScan page to view the DownScan menu.

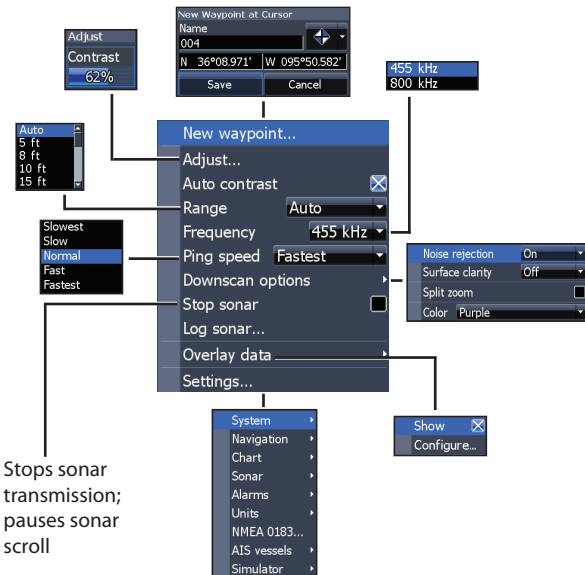

Stops sonar transmission; pauses sonar scroll

New waypoint

Places a waypoint at your current position or at the cursor position. From the new waypoint menu, you can input a waypoint name, select an icon and input a desired latitude/longitude.

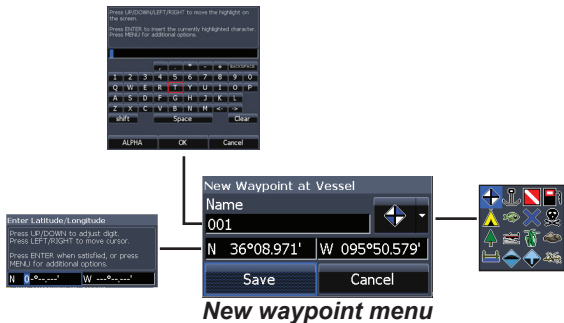

Adjust

Accesses the Contrast adjustment scrollbar, allowing you to adjust contrast settings.



Contrast

Adjusts the brightness ratio between light and dark areas on the screen, making it easier to distinguish suspended objects from the background.

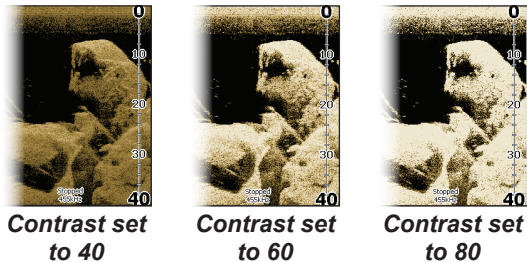

Range

Range settings display the section of the water column from the water surface to the selected depth range.

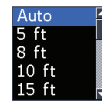

NOTE: Auto range is the preferred setting for most fishing conditions.

Custom range — Upper and Lower limits

Used to select the upper limit and lower limit of a section of the water column. That allows you to view a section of the water column that does not include the water surface.



Upper and lower limits must be at least 6.5 ft (2 m) apart.



NOTE: *When using a custom range, you may not receive any digital depth readings, or you may receive incorrect depth information.*

Frequency

Controls the transducer frequency used by the unit. 800 kHz offers the best resolution, while 455 kHz has greater depth penetration.

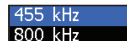

Ping speed

Controls the rate the transducer uses to send sonar waves into the water. Ping speed adjustments can help reduce interference from other transducers.

Downscan options

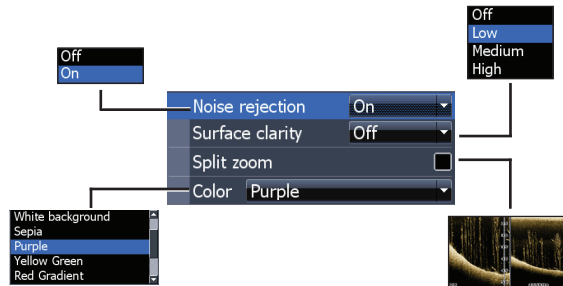

Noise rejection

Uses advanced signal processing to monitor the effects noise (boat pumps, water conditions, engine ignition systems, etc.) has on your display, and then filters out undesired signals.

Surface clarity

Surface Clarity reduces surface clutter by decreasing the sensitivity of the receiver near the surface.

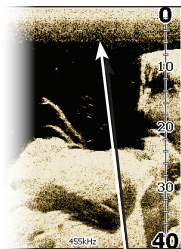

**Surface clarity
set to Low.**

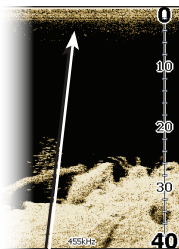

**Surface clarity
set to High.**

Split zoom

Changes the display to a split zoom view.

Color

Allows you to select a color palette best suited to your fishing conditions.

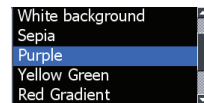

The white background palette works well for suspended targets. Purple is useful for viewing structure detail and determining bottom hardness. Sepia is best for looking at bottom detail.

Stop sonar

Prevents the transducer from transmitting to reduce/eliminate interference between two sonar units running on the boat at the same time.



NOTE: *Sonar history (Trackback) will not be recorded when sonar is stopped.*

Logging sonar

You can record sonar data and save the file on a microSD card inserted into the unit's card reader.

Controls the quality of sonar logs. Higher quality logs will use more memory.

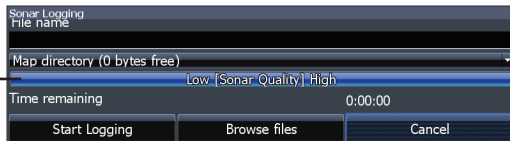

View previously saved sonar logs

Overlay data

Allows you to select data to be displayed on top of the DownScan page.

Overlay data setup is covered in the Pages section.

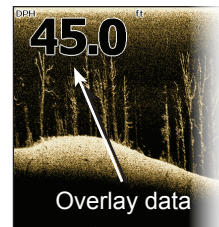

Settings

Accesses the Settings menu. Refer to “Sonar settings” on page 25..

Chart operation

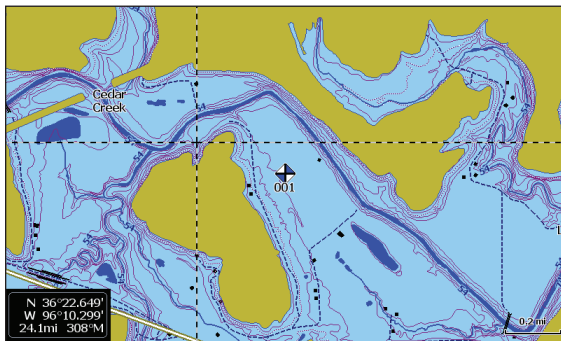

Chart menu

Press **MENU** from any Chart pages to open the Chart menu.

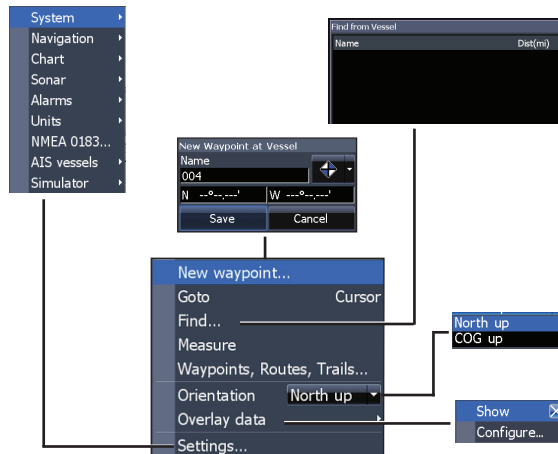

Chart menu

New waypoint

Creates a waypoint at your current location or at the cursor position. When the cursor is on the screen, waypoints will be saved at the cursor position; conversely, if the cursor is not displayed onscreen, waypoints will be saved at your current position.

Waypoints, Routes, Trails

Used to create, edit, navigate and delete waypoints, routes and trails.

Press the keypad left/right to toggle between waypoint, routes and trails tabs.

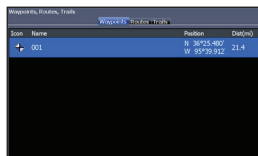

Waypoints Screen

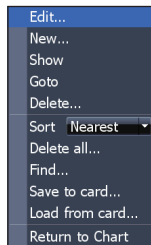

Waypoints menu

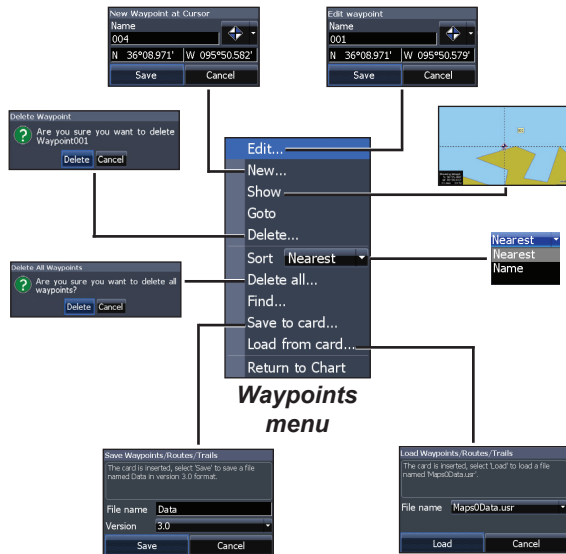

Edit

Allows you to edit the name, icon and latitude/longitude of a selected waypoint.

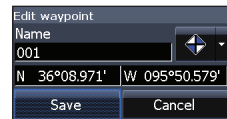

New

Creates a new waypoint at the cursor or vessel position. You can also select waypoint name, icon and latitude/longitude from the new waypoint menu.



Show

Displays the selected waypoint on the map.

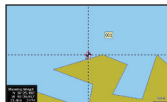

Goto

Allows you to navigate to a waypoint.

Delete and Delete All

Delete is used to delete a selected waypoint. Delete All deletes all waypoints.

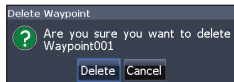

Sort

Controls how the waypoints list will be sorted — by name or by nearest.

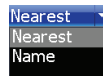

Routes screen

Used to create, edit, navigate and delete routes. Use the keypad to highlight the Routes tab to access the Routes screen.

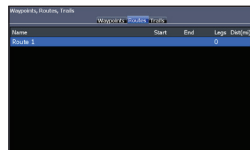

Routes screen

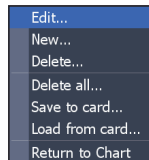

Routes menu

Creating a route

Routes can be created by inserting waypoints from the waypoints list or by using the cursor to position new points on the chart. You also can add waypoints to a route by selecting them from the chart screen.

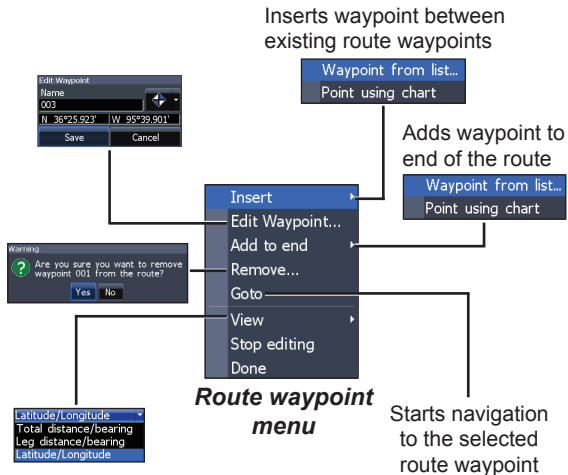

Leg Name field

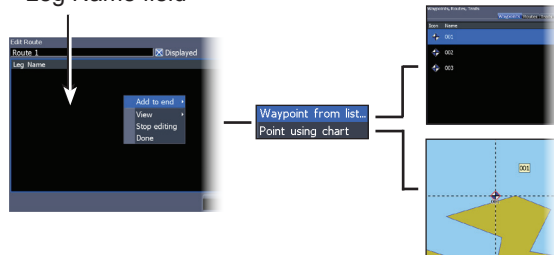

5. Highlight *Waypoint from list* and press **ENTER**.
6. Select the desired waypoint and press **ENTER** twice.
7. Repeat point 6 to add more waypoints.
8. When the route is complete, press **MENU**, select *Stop Adding* and press **ENTER**.
9. Press **MENU**, select *Stop Editing* and press **ENTER**.
10. Select *Save* and press **ENTER**.

To create a route from waypoint list:

1. Press **MENU** from the Routes screen.
2. Select *New...* and press **ENTER**.
3. Press the keypad down to select the Leg Name field and press **ENTER**.
4. Press **MENU**, select *Add to End* and press **ENTER**.

Creating a route using points from chart:

1. Repeat Steps 1-4 from the instructions for Creating a route from waypoint list.
2. Select **Point using chart** and press **ENTER**. The chart page will appear.
3. Move the cursor to the desired location. Press **ENTER** to set a waypoint.
4. Repeat Step 3 to add more route waypoints.
5. Press **MENU** and select **Stop Adding**. Press **ENTER**.
6. Press **MENU**, select **Stop Editing** and press **ENTER**.
7. Highlight the **Save** button and press **ENTER**.

Navigating a route

Routes can be navigated in forward or reverse.

1. Select the desired route on the Route screen and press **MENU**.
2. Select **Start** and press **ENTER**.
3. Select **Forward** or **Reverse** and press **ENTER**.

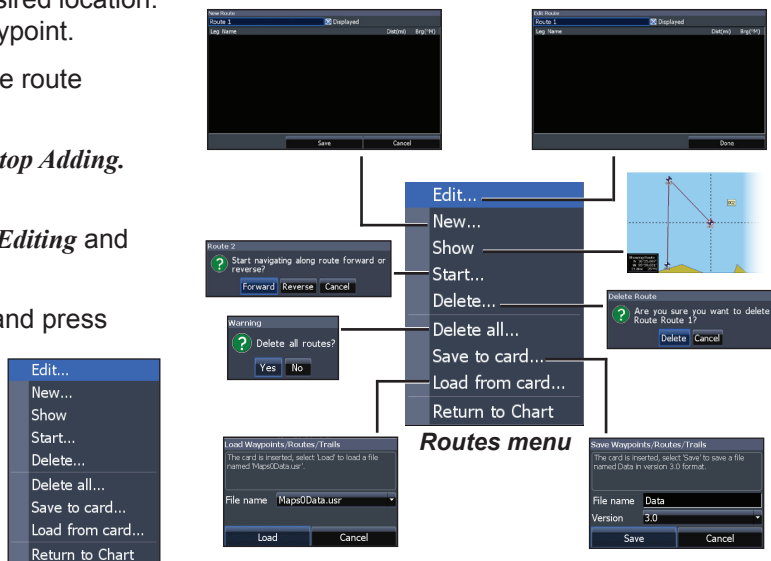

To cancel navigation:

1. Press **MENU** from the chart screen.
2. Select *Navigation* and press **ENTER**.
3. Highlight *Cancel* and press **ENTER**.
4. Select *Yes* and press **ENTER**.

Edit and New Route menus

Used to edit/create routes, route names and to turn on/off the route display.

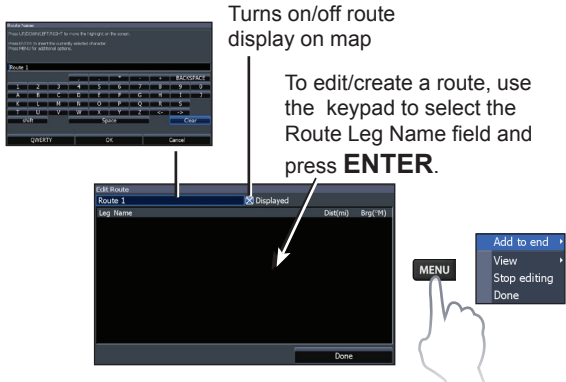

To access the Edit or New Route menu, select *Edit* or *New* on the Routes menu and press **ENTER**.

To finalize changes on the Edit or New Route menus, press **MENU**, highlight *Stop editing* and press **ENTER**. Select *Done* and press **ENTER**.

Displayed

Used to show/hide a route on the display, which prevents the screen from being cluttered by too many routes

Delete and Delete All

Delete is used to delete individual routes. Delete All, removes all routes.

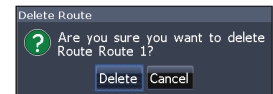

Trails screen

Used to create, edit, navigate and delete trails. Use the keypad to highlight the Trails tab to access the Trails screen.

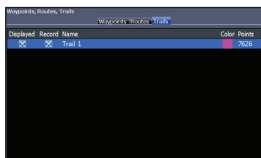

Trails screen

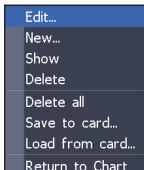

Trails menu

Creating trails

When creating a trail you can customize the trail name and color from the New Trail.

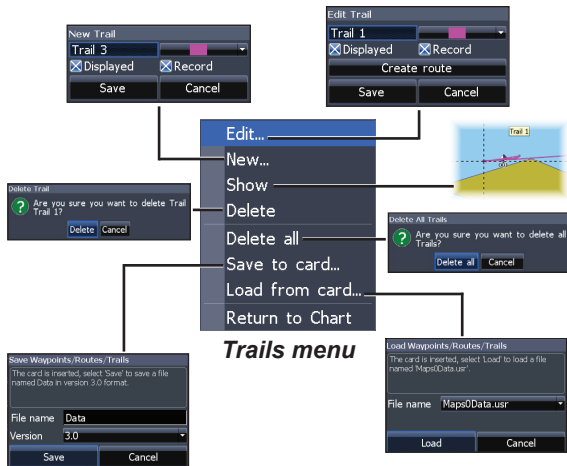

Trails menu

To create a trail:

1. Select *New* and press **ENTER**. The New Trail dialog will appear.
2. Select *Save* and press **ENTER**.

Edit and New Trail menus

Allows you to edit/create trails, select trails names, trail color, trail display and the trail being recorded. You can also convert a trail into a route from the Edit Trail menu.



Turns on/
off trail
display
on map

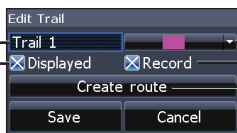

Edit Trails menu

Turns on/
off trail
recording

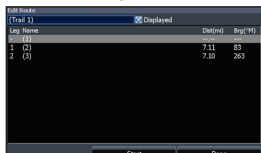

Navigating a trail

A trail must be saved as a route before it can be navigated.

To save a trail as a route:

1. Highlight the desired trail on the Trails screen and press **ENTER**. The Edit Trail menu will appear.
2. Highlight *Create Route* and press **ENTER**. The Edit Route menu will appear.
3. Highlight *Done* and press **ENTER**.
4. For navigation instructions refer to the Navigating a route segment.

Displayed and Record

Displayed allows you to show/hide trails on the map display, preventing the screen from being cluttered with trails.

The Record command allows you to record, stop recording or resume recording a desired trail.

Delete and Delete All

Delete is used to remove individual trails. Delete All removes all trails.

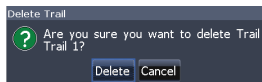

Orientation

Allows you to select North Up or Course Over Ground (COG) as the map orientation.

Overlay data

Allows you to select data (course over ground, etc) to be displayed on top of the Chart page.

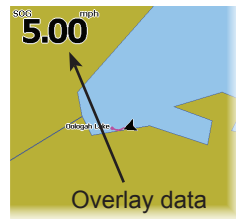

Overlay data setup is covered in the Pages section.

Settings

Accesses the Chart settings menu.

Chart settings

Controls map data used on the chart screen as well as display settings like grid lines, waypoints, routes and trails.

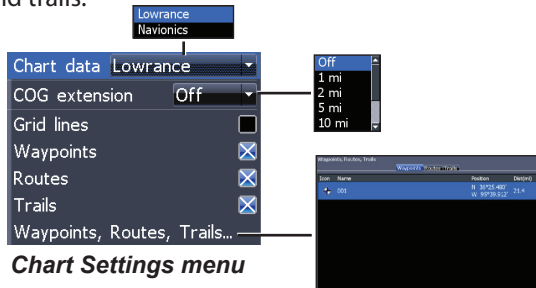

Chart Settings menu

Chart data

Selects map data that will be used on the Chart display (Lowrance or Navionics regional map).

COG extension

A line extending from the front of the current position icon that estimates the time and distance to areas in front of you.



Grid lines

Displays base values for latitude and longitude, making it easier to get a general idea of your location on the latitude/longitude scale.

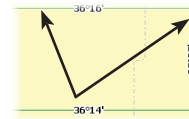

Waypoints, Routes and Trail displays

From the Chart Settings menu, you can turn on/off waypoint, route and trail display properties. Turning off display properties allows you to get a better view of the map, if the screen becomes cluttered with waypoints, routes and/or trails.

Waypoints, Routes, Trails

Accesses the Waypoints, Routes & Trails screen. Waypoints, Routes and Trails are covered in the Chart section.

Navigation settings

(Advanced mode only)

Controls Arrival Radius and Off Course distance settings and is used to turn on/off WAAS/MSAS/EGNOS.

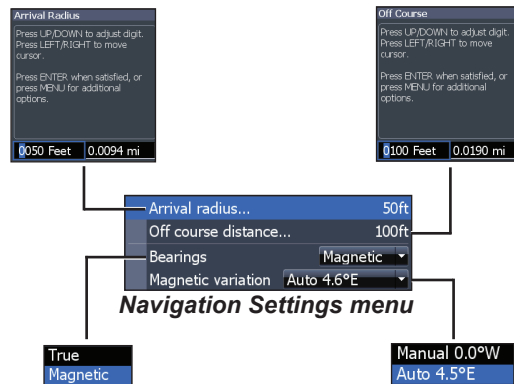

Arrival radius

Sets the arrival radius threshold for the Arrival alarm. The arrival alarm will sound when your vessel comes within a selected distance (arrival radius) of the destination waypoint.

Off Course Distance

Sets Off Course Distance threshold for the Off Course alarm. When the selected off course distance is exceeded, the Off Course alarm will sound when the alarm is enabled.

Bearings

Controls whether bearing will be calculated using True North or Magnetic North. Magnetic North should be used when navigating with a compass course or heading; otherwise use the default setting, True North.

Magnetic variation

Controls whether magnetic variation will be calculated using Automatic or Manual settings. Magnetic variation is the angle between magnetic north and true north. The automatic setting reconciles the variation for you.



WARNING: *You should only use the Manual magnetic variation setting if you have variation information from a verified source.*

AIS

The marine Automatic Identification System (AIS) is a location and vessel information reporting system. It allows vessels equipped with AIS to automatically receive position, speed, course and vessel identity information from other AIS-equipped vessels.

If an AIS device is connected, all targets detected by the device can be displayed.

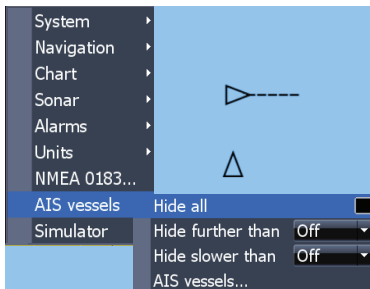

AIS setup

Before using AIS, your unit must be set to the same Baud rate as your AIS device.



NOTE: Your unit must be set to *Advanced mode* to access NMEA 0183 settings (Requires optional Power/NMEA cable 000-0127-49)

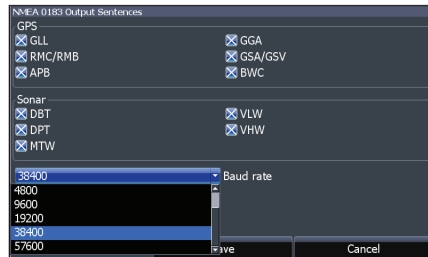

To select a Baud rate:

1. Access the settings menu.
2. Select **NMEA 0183** and press **ENTER**.
3. Access the Baud rate dropdown menu on the NMEA 0183 settings dialog.
4. Select the same Baud rate used by your AIS device.
5. Select **Save** and press **ENTER**.



Target symbols

The unit uses the AIS target symbols shown below:

| Symbol | Description |
|---|---|
|  | Stationary AIS target |
|  | Moving AIS target with (COG) course extension line The extension line always represents the target's course over ground and is set to 10 minutes by default. |
|  | Lost AIS target When no signals have been received within a time limit, a target will be defined as lost. The target symbol represents the last valid position of the target before the reception of data was lost. |



NOTE: *If you receive heading data from an AIS vessel, the orientation of the vessel icon represents its heading. If heading data is not received, the orientation of the vessel icon represents its course over ground (COG).*

Filtering the targets

All targets, by default, are shown on the display if an AIS device is connected to your unit.

You can hide all targets, or filter the target icons based on distance and vessel speed.

Viewing AIS target information

When you place the cursor on an AIS icon, the MMSI number or vessel name (if available) will be displayed.

You can view detailed information about a target by selecting the target and pressing **ENTER**. The AIS Vessel detail dialog will appear.

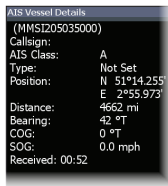

Settings

Settings menu

Accesses installation and configuration settings for your unit.

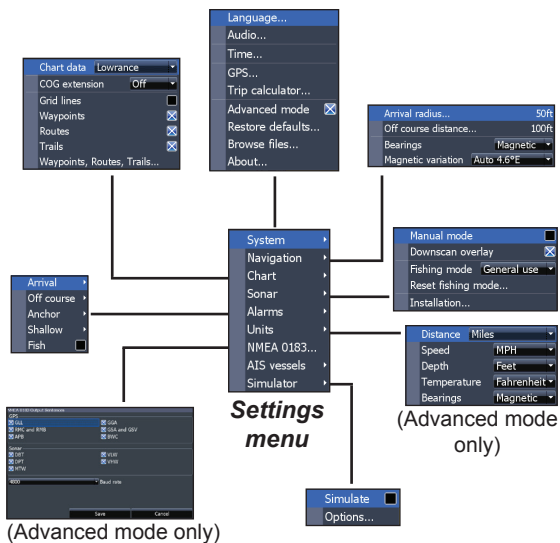

System

Adjusts unit settings like language, mute audio and advanced mode.

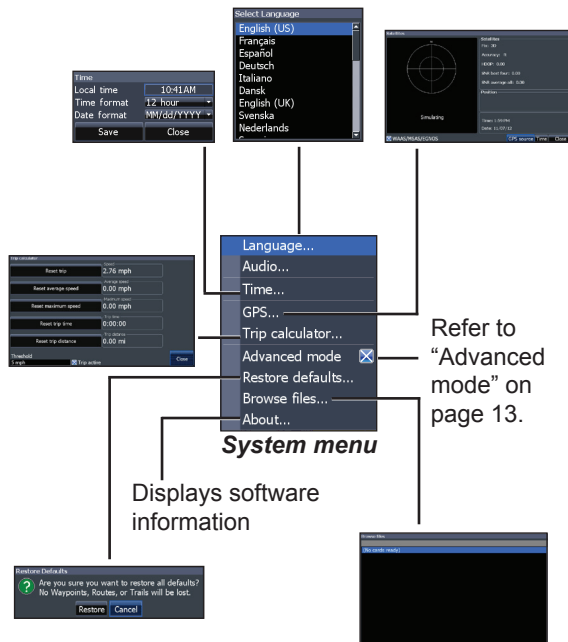

Set language

Selects the language used on menus and dialogs.



Audio

Adjusts volume and turns on/off unit audio, like key beeps, alarm sounds, etc.

Time

Used to set local time, and time and date formats for your unit.

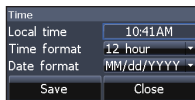

GPS

Monitors the location of satellites in view and the quality of the unit's satellite lock-on.



Trip calculator

Tracks trip time, speed and distance when you are moving faster than the selected threshold.

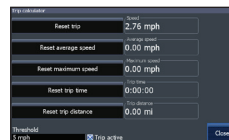

Advanced mode

Enables features and settings only available with unit in Advanced Mode.

Restore defaults

Switches the unit back to default settings.

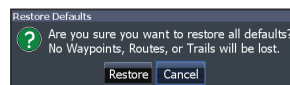

Browse files

Allows you to view a list of the files saved to the microSD card.

Saving screenshots

You can save screenshots to a microSD card by inserting a microSD card into the card slot and pressing Power and then Zoom (+).

You must view files on a computer or other microSD compatible device.



NOTE: *You cannot save screenshots to internal memory, Navionics cards, or other mapping cards.*

About

Displays software information about this unit. Before attempting a software update, you can check the version of software your unit is using by accessing the About screen.

Lowrance periodically updates unit software to add features and improve functionality.

Alarms

Enables alarms and selects alarm thresholds. Arrival, Off Course and Anchor alarms are only available in Advanced mode.

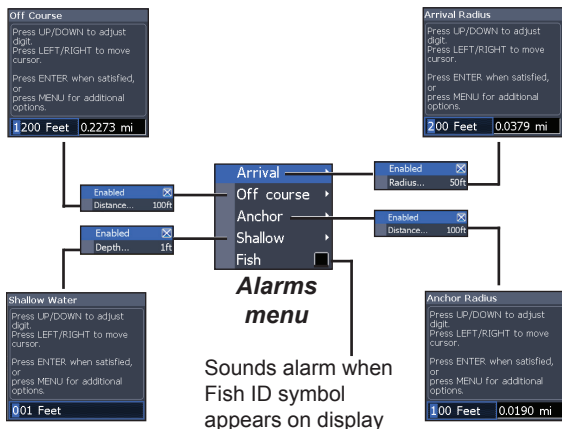

Sounds alarm when Fish ID symbol appears on display

| Alarms | |
|-------------------|--|
| Arrival | sounds alarm when you are within a selected distance of your destination (Advanced Mode only) |
| Off Course | sounds alarm when course exceeds a selected off-course threshold (Advanced Mode only) |
| Anchor | sounds alarm when vessel moves a selected distance (Advanced Mode only) |
| Shallow | sounds alarm when vessel enters water shallower than the selected shallow threshold |
| Fish | sounds alarm when a fish symbol (Fish ID) appears on the sonar screen |

Units

Allows you to select the unit of measure used by the unit. Unit options vary depending on whether the unit is in basic or advanced mode.

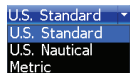

Basic Mode



Advanced Mode

NMEA 0183 Output

(Requires optional Power/NMEA cable 000-0127-49)

You can select the NMEA 0183 sentences the unit will use when connected to a VHF radio or other NMEA 0183 device.

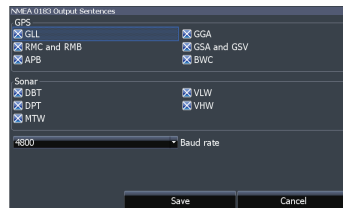

You can also adjust the Baud rate, but the default setting works best under most conditions.

Simulator

Simulates GPS and/or sonar activity. Simulations can be customized on the Simulator options menu.

| HOOK -4 | |
|----------------------------|---|
| General | |
| Case size | 6.6" H (168 mm) x 3.8" W (96 mm); 7.5" H (189 mm) with bracket |
| Display | (4.3" diagonal) 16-bit color TFT LCD |
| Waterproof standard | IPX7 |
| Backlight | LED (11 levels) |
| Communications | NMEA 0183 Input/Output (optional Power/NMEA cable 000-0127-49) |
| Regulatory mark | CE 0980 |
| Power | |
| Transmit power | 500 W RMS |
| Power requirement | 12 V |
| Voltage input | 10 to 17 V |
| Current drain | Typical: 1.1 A |
| Fuse type | 3-amp Automotive |

| Sonar | |
|---|---|
| Max depth | 300 ft (91 m) 455/800 kHz 1000 ft (305 m) 83/200 kHz 2500 ft (762 m) 50/200 kHz |
| Max speed | 70 mph |
| Available transducer frequencies | HDI 50/200 kHz (Low/High CHIRP) HDI 83/200 kHz (Medium/High CHIRP) 83/200 kHz (Medium/High CHIRP) |
| Transducer cable | 20 ft (6 m) |
| GPS | |
| Mapping card slot | microSD and microSDHC |
| GPS Antenna | 16 parallel channel (internal) |
| Mapping compatibility | Lake Insight® and Nautic Insight® PRO, Navionics® +, C-MAP MAX-N, Fishing Hot Spots® PRO, & Insight Genesis. |
| Waypoints, Routes & Trails | Up to 3000 waypoints, 100 routes/100 waypoints per route, 100 retraceable plot trails/up to 10,000 points per trail |

| HOOK -5 | |
|----------------------------|--|
| General | |
| Case size | 5.4" H (136 mm) x 6.9" W (174 mm); 5.9" H (151 mm) with bracket |
| Display | (5" diagonal) 16-bit color Full color VGA Solar MAX™ Plus TFT |
| Waterproof standard | IPX7 |
| Backlight | LED (11 levels) |
| Communications | NMEA 0183 Input/Output (optional Power/NMEA cable 000-0127-49) |
| Regulatory mark | CE 0980 |
| Power | |
| Transmit power | 500 W RMS |
| Power requirement | 12 V |
| Voltage input | 10 to 17 V |
| Current drain | Typical: 1.1 A |
| Fuse type | 3-amp Automotive |

| Sonar | |
|---|--|
| Max depth | 300 ft (91 m) 455/800 kHz 1000 ft (305 m) 83/200 kHz 2500 ft (762 m) 50/200 kHz |
| Max speed | 70 mph |
| Available transducer frequencies | HDI 50/200 kHz (Low/High CHIRP) HDI 83/200 kHz (Medium/High CHIRP) 83/200 kHz (Medium/High CHIRP) |
| Transducer cable | 20 ft (6 m) |
| GPS | |
| Mapping card slot | microSD and microSDHC |
| GPS Antenna | 16 parallel channel (internal) |
| Mapping compatibility | Lake Insight® and Nautic Insight® PRO, Navionics® +, C-MAP MAX-N, Fishing Hot Spots® PRO, & Insight Genesis. |
| Waypoints, Routes & Trails | Up to 3000 waypoints, 100 routes/100 waypoints per route, 100 retracable plot trails/up to 10,000 points per trail |

| HOOK-7 | |
|----------------------------|--|
| General | |
| Case size | 5.3" H (234mm) x 9.2" W (136mm); 5.9" H (151mm) with bracket |
| Display | (7" diagonal) 16-bit color Full VGA Solar MAX™ 800x480 color TFT |
| Waterproof standard | IPX7 |
| Backlight | LED (11 levels) |
| Communications | NMEA 0183 Input/Output (optional Power/NMEA cable 000-0127-49) |
| Regulatory mark | CE 0191 |
| Power | |
| Transmit power | 500 W RMS |
| Power requirement | 12 V |
| Voltage input | 10 to 17 V |
| Current drain | Typical: 1.1 A |
| Fuse type | 3-amp Automotive |

| Sonar | |
|---|---|
| Max depth | 300 ft (91 m) 455/800 kHz 1000 ft (305 m) 83/200 kHz 2500 ft (762 m) 50/200 kHz |
| Max speed | 70 mph |
| Available transducer frequencies | HDI 50/200 kHz (Low/High CHIRP) HDI 83/200 kHz (Medium/High CHIRP) 83/200 kHz (Medium/High CHIRP) |
| Transducer cable | 20 ft (6 m) |
| GPS | |
| Mapping card slot | microSD and microSDHC |
| GPS Antenna | 16 parallel channel (internal) |
| Mapping compatibility | Lake Insight® and Nautic Insight® PRO, Navionics® +, C-MAP MAX-N, Fishing Hot Spots® PRO, & Insight Genesis. |
| Waypoints, Routes & Trails | Up to 3000 waypoints, 100 routes/100 waypoints per route, 100 retraceable plot trails/up to 10,000 points per trail |

| HOOK-9 | |
|----------------------------|---|
| General | |
| Case size | 6.16" H (157 mm) x 11.06" W (281 mm); 6.2" H (156.5 mm) with bracket |
| Display | (9" diagonal) 16-bit color Full color VGA Solar MAX™ Plus TFT |
| Waterproof standard | IPX7 |
| Backlight | LED (11 levels) |
| Communications | NMEA 0183 Input/Output (optional Power/NMEA cable 000-0127-49) |
| Regulatory mark | CE 0980 |
| Power | |
| Transmit power | 500 W RMS |
| Power requirement | 12 V |
| Voltage input | 10 to 17 V |
| Current drain | Typical: 1.1 A |
| Fuse type | 3-amp Automotive |

| Sonar | |
|---|---|
| Max depth | 300 ft (91 m) 455/800 kHz 1000 ft (305 m) 83/200 kHz 3000 ft (914 m) 50/200 kHz |
| Max speed | 70mph |
| Available transducer frequencies | HDI 50/200 kHz (Low/High CHIRP) HDI 83/200 kHz (Medium/High CHIRP) 83/200 kHz (Medium/High CHIRP) |
| Transducer cable | 20 ft (6 m) |
| GPS | |
| Mapping card slot | microSD and microSDHC |
| GPS Antenna | 16 parallel channel (internal) |
| Mapping compatibility | Lake Insight® and Nautic Insight® PRO, Navionics® +, C-MAP MAX-N, Fishing Hot Spots® PRO, & Insight Genesis. |
| Waypoints, Routes & Trails | Up to 3000 waypoints, 100 routes/100 waypoints per route, 100 retraceable plot trails/up to 10,000 points per trail |

Index

- A**
 - About 50
 - Adjust menu 20
 - Advanced Mode 13
 - AIS 45
 - Filtering targets 46
 - Target symbols 46
 - Vessel detail dialog 47
 - Alarms 50
 - Amplitude Scope 24
 - Anchor alarm 51
 - Arrival alarm 51
 - Arrival Radius 44
 - Auto Sensitivity 20
- B**
 - Bearings 44
 - Browse Files 49
- C**
 - Cancel navigation 38
 - Chart 42
 - Chart Data 42
 - Chart menu 42
 - Chart Page 15
 - CHIRP 18
 - COG Extension 42
 - Color 23, 31
 - Colorline 20
 - Contrast 29
 - Creating a route 35
 - Creating trails 39
 - Cursor 12
 - Custom Range 21, 30
- D**
 - Data Port 49
 - Depth Range 29
 - Dialogs 10
 - Dropdown menus 10
 - DSI menu 28
- E**
 - Editing waypoints 34
- F**
 - Fish alarm 51
 - Fish ID 24
 - Fishing Mode 11
 - Fishing Modes
 - Reset 26
 - Frequency 21, 30
- G**
 - Goto cursor 12
 - Goto waypoint 35
 - GPS Source 49
 - GPS Status 49
 - Grid Lines 42
- H**
 - High CHIRP 22
- I**
 - Ice Mode 24
 - Installation menu 27
- K**
 - Keel Offset 27
- L**
 - Language 49
 - Low CHIRP 22

M

Magnetic Variation 44
Man
Overboard
waypoint 6
Man Overboard way-
point 6
Manual Mode 26
Medium CHIRP 22
microSD cards 7
Mute Audio 49

N

Navigating a route 37
Navigating a trail 40
Navigation 43
Navigation menu 43
New Waypoint 33
NMEA 0183 51
Noise Rejection 23, 31

O

Off Course alarm 51
Off Course Distance 44
On/Off features 10
Orientation 41
Overlay Data 17, 32,
41
Configure 17
Show 17

P

Page menus 8
Page selection 8
Ping Speed 22

R

Range 29
Reset Fishing Mode 26
Reset water distance
27
Route display 43
Routes Screen 35

S

Saving Screenshots 50
Scrollbars 10
Sensitivity 20
Setup wizard 8
Shallow alarm 51
Software Updates 50
Sonar Installation 27
Sonar Menu 18
Sonar Options menu
23
Sonar Page 14
Sonar settings 25
Sort waypoints 35
Split Flasher 23
Split Zoom 23
Standby mode 13
Steer Page 14
Stop Sonar 24, 32
Surface Clarity , 23
System settings 48

T

Temperature calibra-
tion 27
Text entry 11
Time 49
Trackback 28
Trail display 43
Trails Screen 39
Turn unit on/off 6

U

Unit Controls 6
Units 51
Upper and Lower Limits
21, 30

W

Waypoint display 43
Waypoints, Routes,
Trails 34
Working with menus
10