

# INSTRUCTIONS FOR CAMSHAFT BEARING TOOL

## Removal Instructions:

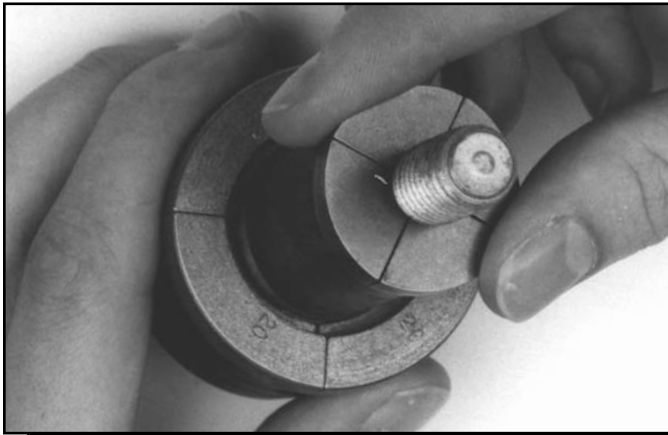

**Step 1** - Select the proper expanding driver from driver range table (see page 2).

Place expanding driver onto expander assembly.

Note: To install or remove expanding driver, always push on or pull from the ends. Pressure on the outside diameter may cause a bind against the rubber expander sleeve.

**Be sure the smooth side of the rubber sleeve is out and that the sleeve is coated with rubber lubricant to facilitate installing the driver on the expander.**

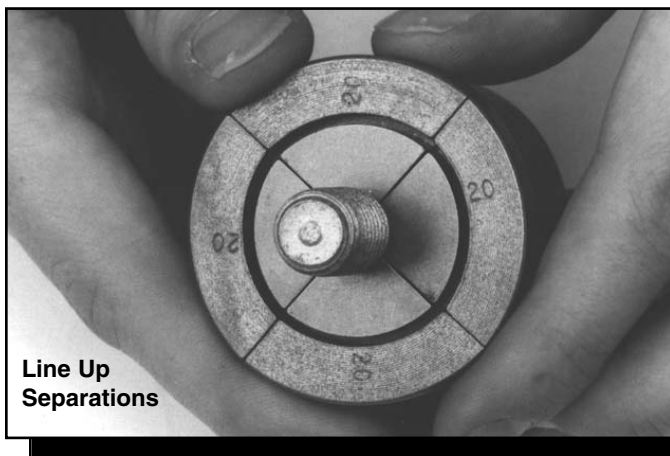

**Step 2** - Check to insure that separation lines between segments of expanding driver line up with separation lines on the expander assembly as above.



**⚠ WARNING:**  
Wear eye protection.

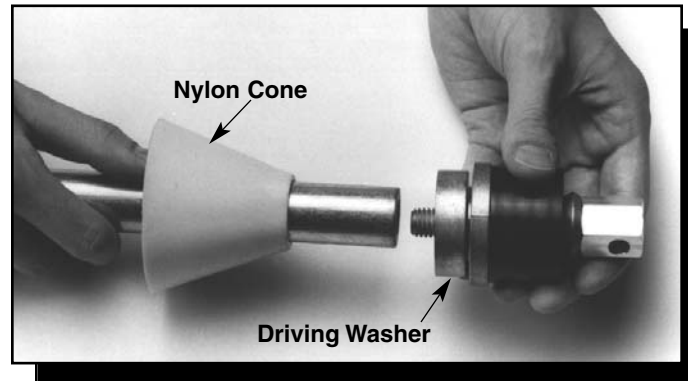

**Step 3** - Place nylon cone over the driving bar. Then select the proper driving washer from the driver range table (see page 2). It is important to use the proper driver washer to prevent damage to the expander assembly. Place the driving washer over the threaded portion of the expander assembly. Screw expander assembly with driving washer into driving bar. (The driver bar extension may be needed for removal of the rear bearings.)

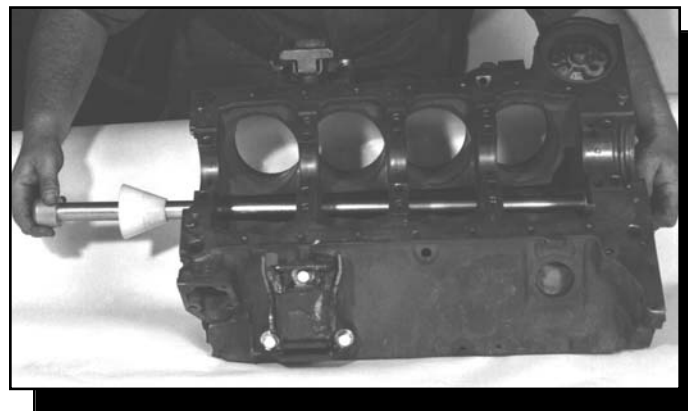

**Step 4** - Operate tool from front of block. Insert into rear bearing and tighten until snug in bearing. (over)

Note: On some blocks the camshaft is inaccessible except from either end. (There are no openings as you see in this illustration). In this case you must use a socket and extension to enlarge and reduce the expander assembly as you remove (or install) each bearing.

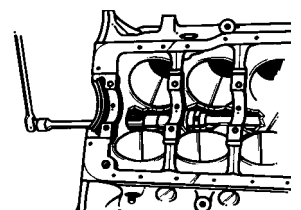

## Removal Instructions continued



**Step 5** - Place nylon cone in first bearing housing and drive bearing out. Loosen driver assembly to relieve pressure and pull tool back through the next bearing to be driven. Repeat above steps until all bearings are removed.

## PARTS LIST:

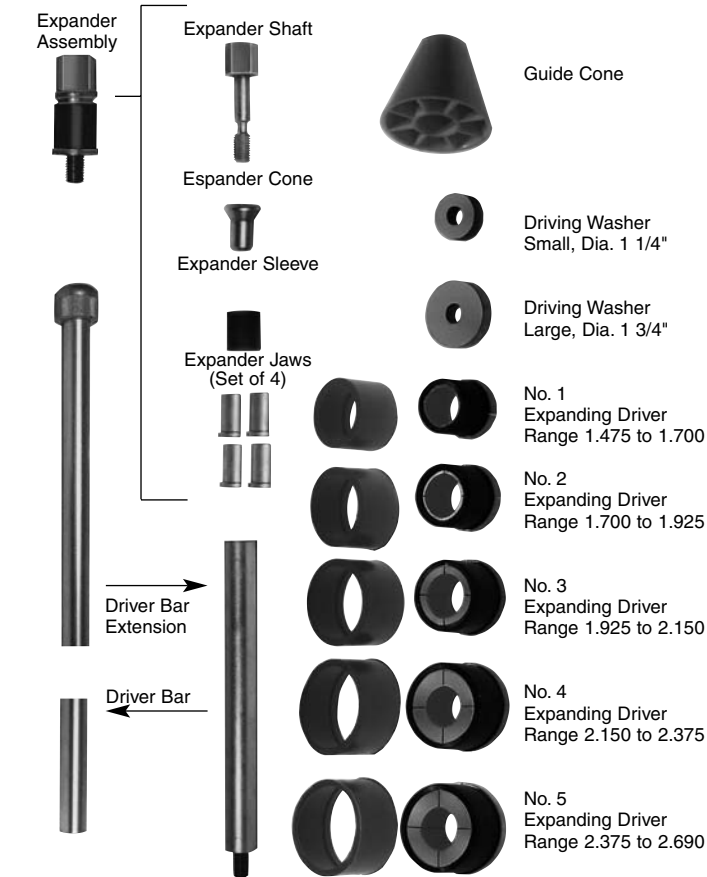

**⚠ WARNING:**  
Wear eye protection.

BEARING SIZE I.D.
1.125 to 1.475
1.475 to 1.700
1.700 to 1.925
1.925 to 2.150
2.150 to 2.375
2.375 to 2.690

DRIVER RANGE TABLE	EXPANDING DRIVER
	Expander Assembly
	No. 1
	No. 2
	No. 3
	No. 4
	No. 5

USE WASHER
Small
Small
Large
Large
Large

**NOTE:** This tool has two sets of rubber sleeves supplied with it for the expanding drivers. The brown sleeves are used when driving thin wall bearings (.065). The black sleeves should be used when driving thick wall bearing (.090). See instructions below for changing the sleeves.

**NOTE:** The old style expanding drivers used four "O" rings to hold the drivers together. The new style drivers are held together by a rubber sleeve. The replacement rubber sleeves carry the same part number as the corresponding size of "O" ring sets. The replacement rubber sleeves *will work* on old style drivers that originally came with "O" rings. The change was made to improve the function of the tool.

## INSTALLATION INSTRUCTIONS:

**Note:** The alignment of cam bearing bores can change as an engine block ages and in some cases the bores can get out of round. When new bearings are installed in such a block, the camshaft may be difficult or impossible to install properly. Small amounts of warp may be corrected by scraping the bearing but large amounts need to be corrected by align boring or honing. Either of the above conditions may make cam bearings difficult to install and may result in damaged bearings.

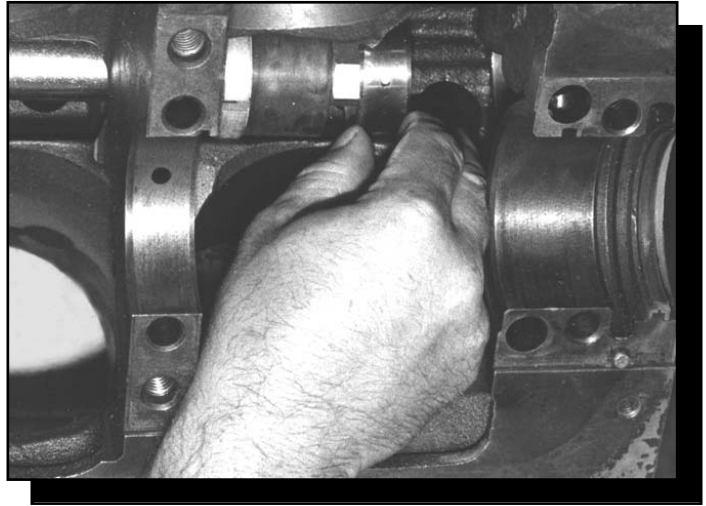

**Step 1** - Reduce the expander assembly to its smallest size before installing bearings. Check the separation lines for proper alignment as in figure 2, page 1. Insert tool from the front of the block through the cam bearing housings until immediately in front of the rear bearing housing. Place bearing on expanding driver and tighten until bearing is held firmly.

**CHECK THE MANUFACTURER'S SPECIFICATION TO MAKE SURE THE OIL HOLES IN THE BEARING ARE POSITIONED IN THE PROPER LOCATION.**

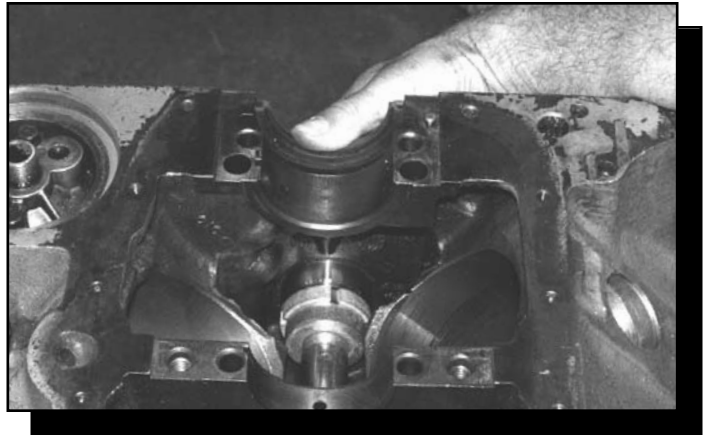

**Step 2** - Hold guide cone in place in number one housing and drive bearing. Repeat above steps until all bearings are driven except the number on bearing. To drive the number one bearing, operate from the rear of the engine using the guide cone in the rear housing.



To REMOVE expanding driver segments, simply squeeze unit one of the four segments pops free.

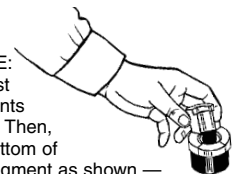

To REPLACE: Place the first three segments into position. Then, insert the bottom of the fourth segment as shown — pushing it down into the sleeve.