

2019 FIREARM PRODUCT CATALOG



LIMBSAVER

INDUSTRY LEADERS

Always pursuing advancement, we are constantly researching, testing, and evaluating technologies, materials, and designs to ensure that we produce the most effective sound and vibration-dampening products possible.

Well-known companies from around the world come to us to have their products tested, evaluated, and improved by our engineers.

OUR ROOTS

We believe that the best products are born from hard work and determination. From the very beginning, here at LimbSaver®, we have been committed to engineering the most advanced products utilizing the most state-of-the-art technology.

Throughout the years, we have been trail-blazers in the industry, producing the most effective noise and vibration-dampening technology.

AMERICAN MADE

The vast majority of our products are made right here in Shelton, WA. For two decades we have been making the highest quality and best performing archery and firearms products in the world.

We have always employed teams of industry experts and engineers that design, test, and perfect every single product, ensuring that what is produced is the best in the world.

We are avid sportsmen, competition shooters, and hunters and we make products that we are excited to use.

NAVIGATION

PRODUCTS	PAGE
Holsters.....	04-11
Recoil Pads.....	12-23
Slings.....	24-27
Handgun Grips.....	28-29
Shooting Accessories.....	30-31

GUIDES	PAGE
Special Order Products.....	32-33
Recoil Pad Fitting Guide.....	34-47

LIMBSAVER

LEADING THE INDUSTRY IN
PERFORMANCE • INNOVATION
CUSTOMER SERVICE



HOLSTERS

CROSSTECH™

UNIVERSAL HOLSTER SYSTEM



NEW FOR 2019

COMPACT - CLIP ON SMALLER FOOTPRINT, EASIER CARRY

OWB/IWB compatible belt clips
SIZING: Customize at home to fit most micro compact to full-size pistols



LEATHER CLASSIC COMFORT

HIGH QUALITY LEATHER
OWB/IWB compatible belt clips
SIZING: Customize at home to fit nearly any handgun



Which CrossTech Holster is right for you?

THE ORIGINAL - CLIP ON UNIVERSAL FIT, EXTREME COMFORT

CUSTOMIZABLE COMFORT
OWB/IWB compatible belt clips
SIZING: Customize at home to fit nearly any handgun



CLIP ON W/ SECURE STRAP EXTRA RETENTION

OWB/IWB compatible belt clips
SIZING: Customize at home to fit nearly any handgun



BELTED W/ SECURE STRAP Highest Accessibility

WEAR OVER OUTER LAYER OF CLOTHING
Belt buckles over jacket or camo - best for hunting and outdoor use
SIZING: Customize at home to fit nearly any handgun



Customer Reviews

★★★★★
Utility Knife of Holsters

Bought two as they're versatile, modular, comfortable, both IWB and OWB. Retention is great, and it completely covers the trigger. Wear was something I was concerned about when I purchased the first one. After form fitting it I used it plenty of times and long enough that I felt comfortable getting a second and doing the same.

★★★★★
One of the Best Holsters I Own

The CrossTech is very comfortable and very concealable; I can barely feel it and it doesn't weigh me down. My FN509 has finally found a home... This is one very nicely crafted, tough holster. It's amazing how easy it is to maneuver from OWB to IWB, and it saves money and shopping time searching for extra holsters.

CROSSTECH™

A CUSTOM FIT HOLSTER *for nearly every pistol*

Fits Glock, Smith & Wesson, Ruger, HK, Sig Sauer, FN Herstal, Colt, Kel-Tec, Kahr Arms, Kimber, Taurus, Steyr Arms, Walther, Springfield, Beretta, CZ, all 1911 handguns, and many others.

EDC COMFORT *at its finest*

The CrossTech Holster is flexible and comfortable enough for every day carry (EDC).



The CrossTech is a revolutionary **HEAT ACTIVATED** *custom holster* *system*

Conforms to your handgun in minutes using a heat gun or oven.

CUSTOMIZE IT *your way*

Adapt this holster to meet your needs: Choose from IWB or OWB, right-hand or left-hand, gun angle, shallow or deep concealment, and customize it to fit almost any handgun.



OWB



IWB

CUSTOMIZATION

From full frame to subcompact and semi auto to revolver, the CrossTech Holster can be easily customized at home to fit nearly any handgun.

For a custom, comfortable fit, just reconfigure the Adjustment Bolts and then use a heat gun or oven to conform the holster to your handgun. It only takes a few minutes!



TOP COMFORT

The CrossTech Holster is comfortable enough to wear all day, and reliable enough to be the holster you choose to use for daily carry.

It is made out of a soft, flexible material that eliminates pinching, pressure points, and uncomfortable digging-in associated with hard-shell holsters, yet stiff enough to ensure proper trigger guard.



The new smaller, more compact size makes comfortable concealment even easier for micro-compact, subcompact, compact, and some full-size pistols

FEATURES

- Smaller size is perfect for micro-compact to compact handguns as well as some full frame sizes
- Designed for maximum comfort
- Adjustment Bolt System makes it easy to customize the fit of the holster
- Heat-activated material forms to the general shape of your pistol when a heat gun or oven is used
- Ultra-strong belt clips convert from IWB to OWB in minutes
- Ambidextrous, adjustable cant, shallow to deep concealment, multiple carry positions



COMPACT VS. ORIGINAL size comparison

CROSSTECH HOLSTER COMPACT 12507

Customize at home for optimum comfort and to fit virtually any handgun

FEATURES

- Ambidextrous, adjustable cant, shallow to deep concealment, multiple carry positions
- Ultra-strong belt clips convert from IWB to OWB in minutes
- Designed for maximum comfort
- Adjustment Bolt System makes it easy to customize the holster to fit nearly any handgun
- Heat-activated material forms to the general shape of your pistol when a heat gun or oven is used
- **SECURE STRAP** (on 12504/12506) wraps around the top of the handgun and snaps into place - providing retention and security



CROSSTECH HOLSTER 12501
CROSSTECH HOLSTER W/ SECURE STRAP 12504

Optional Secure Strap



Designed to be worn on top of your outer layer and is great for hunters and outdoor enthusiasts

FEATURES

- Durable, adjustable belt has an easy-to-use buckle - maximum belt length: 65"
- Adjustment Bolt System makes it easy to customize the holster to fit nearly any handgun
- Heat-activated material forms to the general shape of your pistol when a heat gun or oven is used
- Ambidextrous, adjustable cant
- Secure Strap wraps around the top of the handgun and snaps into place - providing retention and security



CROSSTECH HOLSTER - BELTED W/ SECURE STRAP 12506



*This holster must be used with attached belt

CROSSTECH™ HOLSTER



LEATHER - COMFORT AND CLASS



The Leather CrossTech Holster marries comfort and class. We designed the leather CrossTech to have the same universal fit and customization of the original CrossTech, but now with a traditional look and feel.

This premium holster is made from high-quality, genuine leather for maximum durability and comfort. It only gets better with age.

EASY ADJUSTMENT



Watch installation

From full frame to subcompact and semi-auto to revolver, the CrossTech Leather Holster can be easily customized at home to fit any handgun.

The Adjustment Bolt System allows you to change the fit of the holster. Water-activated forming method causes leather to shape around your pistol in minutes.

CROSSTECH HOLSTER - LEATHER

NEW FOR 2019

Classic leather style and comfort meets versatility and customization for a refined yet rugged every day carry holster



CROSSTECH HOLSTER LEATHER - LARGE
12521 Light Brown
12522 Dark Brown

CROSSTECH HOLSTER LEATHER LARGE W/ SECURE STRAP
12523 Light Brown
12524 Dark Brown

CROSSTECH HOLSTER LEATHER - COMPACT
12526 Light Brown
12527 Dark Brown



FEATURES

- Made out of genuine, premium leather which gives you long-wear durability
- Designed for maximum comfort
- Adjustment Bolt System makes it easy to customize the fit of the holster
- Water-activated forming method causes leather to shape around your pistol for a perfect fit
- Ultra-strong belt clips convert from IWB to OWB in minutes
- Ambidextrous, adjustable cant, shallow to deep concealment, multiple carry positions
- Two sizes available: Large (CrossTech Original) and Compact
- **Secure Strap** (optional) wraps around the top of the handgun and snaps into place, providing retention and security

Optional Secure Strap



Large
Light Brown



Compact
Dark Brown

CROSSTECH HOLSTER - WITH LEATHER INLAYS

NEW FOR 2019

Handcrafted custom leather inlays add a sophisticated touch



FEATURES

- Exotic inlay options available, including genuine snake and stingray leather (shown above)
- Hand-sewn, saddle stitch leather detailing
- Two sizes available: Large (CrossTech Original) and Compact
- Same great features as our regular CrossTech Leather holsters (see above for details)



CROSSTECH HOLSTER LEATHER WITH INLAYS
Special Order - Contact LimbSaver for Details



RECOIL PADS



Customer Reviews



Great Recoil Pad

Installed on a Tikka T3 in 7mm Rem Mag. Recoil pad makes a big difference and allows for all day shooting with a lightweight magnum. Felt recoil is reduced to feel just slightly heavier than my .270.



Problem Solved

I Highly recommend the [AirTech® Slip-On] recoil pad for the Mosin-Nagant M44. My only problem (with my rifle) is the horse-like kick and the bruised shoulder the next day. Problem solved.



Angels Were Singing...

Holy smokes! I recently bought a Turkish Girsan MC312 HDT (Heavy Duty Tactical) semi-auto shotgun... Shooting magnum turkey loads or magnum buckshot was utter punishment. It was even harsh with the 2 3/4" shells.

I went to the range yesterday after installing the AirTech® pad, and it was a totally different experience. I ended up wanting to spend the afternoon shooting the shotgun! I have to say, I'd go online and sing a song about this AirTech pad, because it **turned my shotgun from harsh to comfy!**

Find the perfect recoil pad to protect your shoulder

Up to 70% felt-recoil reduction
on wood, synthetic, laminate, and composite stocks!

AIRTECH® PRECISION-FIT HIGH-TECH SHOULDER PROTECTION

Designed for a precise fit on specific stocks.
Many sizes available.
Up to 70% reduction of felt recoil.



AIRTECH® SLIP-ON COMPATIBLE WITH MOST STOCKS

4 sizes fit nearly every stock size.
Simple installation!
Up to 70% reduction of felt recoil.



CLASSIC PRECISION-FIT GREAT PROTECTION; CLASSIC LOOK

Designed for a precise fit on specific stocks.
Many sizes available.
Up to 70% reduction of felt recoil.



CLASSIC SLIP-ON EASY-TO-FIT SIZING

4 sizes fit nearly every stock size.
Easy, slip-on installation!
Up to 70% reduction of felt recoil.



CLASSIC GRIND-TO-FIT MOST CUSTOMIZABLE; GREAT PROTECTION

Grind away for a perfect fit for
nearly any stock.
Up to 70% reduction of felt recoil.



SPEED MOUNT GRIND-TO-FIT SPECIAL SLOPED DESIGN

Grind away for a perfect fit.
Up to 70% reduction of felt recoil.

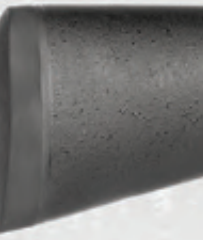

LOW PROFILE GRIND-TO-FIT MINIMAL INCREASE TO LENGTH OF PULL

Only 5/8" thick!
Grind away for a perfect fit.
Up to 60% reduction of felt recoil.



TAC-10 STABLE SHOOTING PLATFORM W/ 10 MICRO-ADJUSTMENT POSITIONS

Provides a stable and comfortable shooting
platform on commercial and mil-spec sized
receiver tubes.
Up to 60% reduction of felt recoil.



AR-15 SNAP-ON HIGHLY COMPATIBLE

Fits most 6-position mil-spec
tactical stocks.
Up to 60% reduction of felt recoil.



NEW FOR 2019: FITS MAGPUL MOE SL

MAGPUL V2 PRECISION-FIT GREAT RECOIL PROTECTION FOR MAGPUL MOE SL STOCKS

Up to 60% reduction of felt recoil.



MAGPUL PRECISION-FIT LOW PROFILE PROTECTION FOR MANY POPULAR MAGPUL STOCKS

Fits STR, SCS, ACS-L, MOE, and
Com/Mil-Spec CTR.
Up to 60% reduction of felt recoil.



AIRTECH

ADVANCED RECOIL REDUCTION SYSTEM



ADVANCED RECOIL REDUCTION

Give your shoulder a break! AirTech® recoil pads offer premium protection for your shoulder so you can enjoy a day of shooting without the usual discomfort and bruising.

They feature **advanced atmospheric chambers** and utilize **NAVCOM®** (Noise and Vibration Control Material) technology to **reduce felt recoil by up to 70%**.



**UNMATCHED
RECOIL
PROTECTION**

**REDUCE
UP TO 70%
OF FELT RECOIL**



■ FACTORY RECOIL PAD - 7MM MAG
■ LIMBSAVER® AIRTECH® RECOILPAD
 RIFLE TESTED TIKKA T3 7MM MAG
 (LOWER IS BETTER)

SHOOT MORE ACCURATELY



AirTech® pads help to increase your accuracy by giving you a stable shooting platform that grips to your shoulder and stays in place even in the rain. They incorporate **anti-muzzle-jump technology** for quick and accurate follow-up shots.

Additionally, by reducing felt recoil and pain, you will be **less likely to flinch**, which will make you a more consistent shooter overall.

AIRTECH® PRECISION-FIT RECOIL PAD

STOCK-SPECIFIC SIZING

Optimum protection for your shoulder with this stock-specific recoil pad. Models are available for most popular guns and stocks.



Go to page 34-47
for sizing and templates



FEATURES

- Reduces up to 70% of felt recoil
- Anti-muzzle jump technology
- Flinch less and shoot more accurately
- Pads are designed to fit specific gun stocks
- Easy Installation: AirTech® Precision-Fit Pads can be installed using factory screws and screw holes
- 1-inch thick (LOP)

NOTE: Designed for use on flat stocks only



AIRTECH® SLIP-ON RECOIL PAD

4 SIZES AVAILABLE

Recoil protection, available in four sizes to fit virtually all stocks

FEATURES

- Reduces up to 70% of felt recoil
- Anti-muzzle jump technology
- Flinch less and shoot more accurately
- 4 sizes to fit nearly every gun stock
- Easy installation! Just slip it over the butt of your bare firearm stock to get legendary shoulder protection
- 1/2-inch and 1-inch thick (LOP) options available



AIRTECH® SLIP-ON SIZING CHART

10549	SM / MED	1/2" THICK	4 1/8" X 1 1/8"	up to	5 1/8" X 1 3/4"
10550	SMALL	1" THICK	4 1/2" X 1 1/2"	up to	4 3/4" X 1 1/4"
10551	MEDIUM	1" THICK	4 3/8" X 1 1/8"	up to	5" X 1 1/4"
10552	LARGE	1" THICK	5" X 1 1/4"	up to	5" X 1 1/8"

Classic Recoil Pads



RECOIL REDUCTION

LimbSaver® Classic Recoil Pads protect your shoulder from the pain of recoil. They enable you to shoot longer without discomfort and bruising, while also helping to increase accuracy of follow-up shots and provide improved control for maximum stability.

Pads are made from LimbSaver's proprietary NAVCOM® technology (Noise and Vibration Control Material), which effectively absorbs a wide range of frequencies to dissipate energy and vibration.

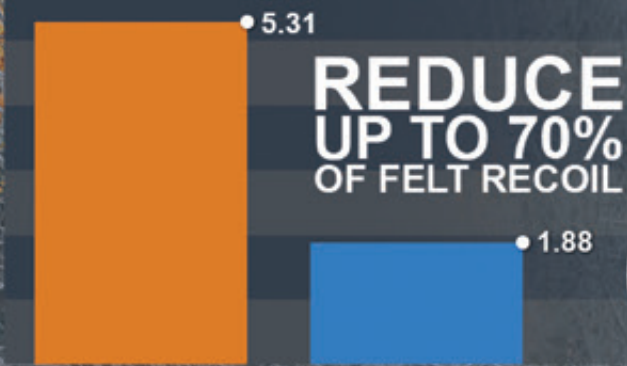

FACTORY RECOIL PAD - 12GA
LIMBSAVER CLASSIC RECOIL PAD

RIFLE TESTED REMINGTON 870 - 12GA
(LOWER IS BETTER)

SHOOT MORE ACCURATELY



LimbSaver® Classic Recoil pads help to increase your accuracy by giving you a stable shooting platform that grips to your shoulder and stays in place even in the rain. They incorporate anti-muzzle-jump technology for quick and accurate follow-up shots.

Additionally, by reducing felt recoil and pain, you will be less likely to flinch, which will make you a more consistent shooter overall.

CLASSIC PRECISION-FIT RECOIL PAD

STOCK-SPECIFIC SIZING

Designed to reduce recoil on specific gun stocks. Models are available for most popular guns and stocks.



Go to page 34-47 for sizing and templates

PART #: 10101
Template Dimensions:
5.00" x 1.825"
(Approx.) 5" x 1.50"

FEATURES

- Reduces up to 70% of felt recoil
- Anti-muzzle jump technology
- Flinch less and shoot more accurately
- Pads are designed to fit specific gun stocks
- Easy Installation: Precision-Fit Pads can be installed using factory screws and screw holes
- 1-inch thick (LOP)

NOTE: Designed for use on flat stocks only



CLASSIC SLIP-ON RECOIL PAD

5 SIZES AVAILABLE

Classic shoulder protection, available in four sizes to fit virtually every stock

FEATURES

- Reduces up to 70% of felt recoil
- Anti-muzzle jump technology
- Flinch less and shoot more accurately
- 4 sizes to fit nearly every gun stock
- Easy installation! Just slip it over the butt of your bare firearm stock to get legendary shoulder protection
- 1/2-inch and 1-inch thick (LOP) options available



CLASSIC SLIP-ON SIZING CHART

10545	SM / MED	1/2" THICK	4 5/8" X 1 1/8"	up to	5 1/8" X 1 3/4"
10546	SMALL	1" THICK	4 1/2" X 1 1/2"	up to	4 3/4" X 1 1/2"
10547	MEDIUM	1" THICK	4 3/8" X 1 5/8"	up to	5 1/8" X 1 3/4"
10548	LARGE	1" THICK	5 1/8" X 1 1/4"	up to	5 1/8" X 1 1/8"



GRIND TO FIT

Recoil Pads



PERFECT FIT

Our Grind-to-Fit® Recoil Pads are the ideal solution for people who want that perfect, custom fit, and also for those who have a stock for which we do not have a Precision-Fit match.

Grind-to-Fit® recoil pads offer the greatest customization of any LimbSaver® recoil pad. They are designed to be perfectly tailored to fit your stock using a belt grinder. We recommend that professional shops modify and install these pads.



UNIQUE STYLES

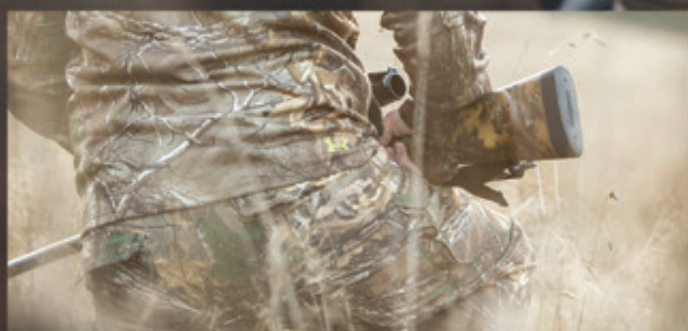

In addition to the traditional 1"-thick pad, we provide our customers with some unique recoil pad styles that are offered exclusively in our Grind-to-Fit® line. Many shooters prefer the specialized designs, such as the Low Profile, Speed Mount, Trap, or Nitro Pads due to their different needs.

Please see page 32 for special order Grind-to-Fit® styles.

GRIND-TO-FIT® SIZING CHART

SMALL	4 ¹³ / ₁₆ "	x	1 ²⁷ / ₃₂ "	(Grindable to 3 ⁷ / ₈ "	x	1 ¹¹ / ₃₂ "
MEDIUM	5 ³ / ₃₂ "	x	1 ¹³ / ₁₆ "	(Grindable to 4 ¹ / ₄ "	x	1 ⁵ / ₁₆ "
MED. PLUS	5 ¹ / ₂ "	x	1 ¹¹ / ₃₂ "	(Grindable to 3 ²⁸ / ₃₂ "	x	1 ¹¹ / ₃₂ "
LARGE	5 ⁹ / ₁₆ "	x	2 ³ / ₁₆ "	(Grindable to 4 ⁷ / ₁₆ "	x	1 ⁹ / ₃₂ "



GO TO PG. 34-47
FOR SIZING AND TEMPLATES

CLASSIC GRIND-TO-FIT® RECOIL PAD

1" THICK

Grind down for a custom fit that looks like it's part of your stock



CLASSIC GRIND-TO-FIT®

10541 Small
10542 Medium
10543 Large



FEATURES

- Reduces up to 70% of felt recoil
- Size is altered with belt sander to perfectly fit your stock - we recommend having a gunsmith install the pad
- Anti-muzzle jump technology
- Flinch less and shoot more accurately
- Pads can be installed using factory screws and screw holes
- 1-inch thick (LOP)

LOW PROFILE GRIND-TO-FIT® RECOIL PAD

5/8" THICK

Great for shooters who want a minimal increase to the length of pull, but still need great recoil reduction

FEATURES

- Thinner 5/8-inch pad is ideal for shooters who don't want to increase length of pull (LOP)
- Curved design makes shouldering quicker and easier
- Size is altered with belt sander to perfectly fit your stock - we recommend having a gunsmith install the pad
- Reduces up to 60% of felt recoil
- Anti-muzzle jump technology
- Flinch less and shoot more accurately



LOW PROFILE GRIND-TO-FIT®
10544 Medium Plus

SPEED MOUNT® GRIND-TO-FIT® RECOIL PAD

1" THICK, SLOPED

Sloped design makes rapid shouldering easier and is perfect for sport shooters



SPEED MOUNT GRIND-TO-FIT®
10540 Medium Plus

FEATURES

- Special sloped design makes shouldering quicker and easier - great for sport shooters
- Size is altered with belt sander to perfectly fit your stock - we recommend having a gunsmith install the pad
- Reduces up to 70% of felt recoil
- Anti-muzzle jump technology
- Flinch less and shoot more accurately
- 1-inch thick (LOP)

TACTICAL Recoil Pads



NEW FOR 2019

Here to fulfill popular demand is our brand new Magpul® V2 Precision-Fit Recoil Pad for MOE SL stocks.

BETTER PRECISION

LimbSaver® recoil pads for Magpul® stocks give you a stable shooting platform. Each of our tactical buttstock accessories incorporate anti-muzzle jump technology that allows for faster target re-acquisition and helps increase accuracy of follow-up shots. You will enjoy heightened control and maximum stability.

It's no secret that flinching results in poor accuracy. A comfortable shooting experience is key to your precision. If you are feeling discomfort or pain while putting a lot of rounds down range, this may cause undesirable groupings.

LimbSaver® tactical pads protect your shoulder from recoil. Made from our proprietary NAVCOM® technology (Noise and Vibration Control Material), the recoil pads reduce up to 60% of felt recoil for comfortable shooting. Flinch less, shoot better.

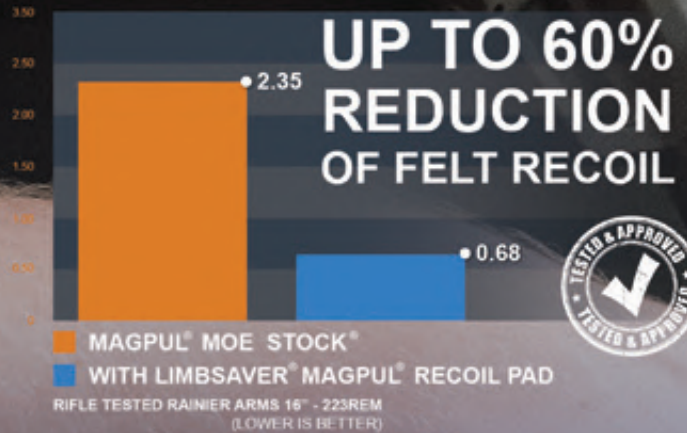

Customer Reviews

★★★★★
Most Comfortable

I ordered this recoil pad to replace the stock butt pad on a Magpul CTR milspec carbine stock. Installation was fast and straight forward. This replacement recoil pad is well made and is the most comfortable butt stock pad I have used. Definitely a worth while investment.

★★★★★
Great Value for the Money!

In my view these are the best recoil pads available for the AR-15 platform! When used in conjunction with a good muzzle break, muzzle jump is eliminated allowing unbelievably fast follow-up shots.

MAGPUL® V2 PRECISION-FIT RECOIL PAD

NEW FOR 2019
5/8" THICK PAD

Upgraded performance for Magpul® MOE SL Carbine Stocks



MAGPUL® V2 PRECISION FIT
10829 Black



FEATURES

- Easy-to-install recoil pad helps reduce up to 60% of felt recoil and increase stability for improved control
- Incorporates anti-muzzle jump technology for faster target re-acquisition
- Non-slip surface ideal for use in all harsh weather conditions and helps keep stock securely positioned on your shoulder
- Fits Magpul® MOE SL stocks

MAGPUL® PRECISION-FIT RECOIL PAD

5/8" THICK PAD

Adds comfort and performance to Magpul® stocks



MAGPUL® PRECISION FIT
10025 Black



FEATURES

- Easy-to-install recoil pad helps reduce up to 60% of felt recoil and increase stability for improved control
- Incorporates anti-muzzle jump technology for faster target re-acquisition
- Non-slip surface ideal for use in all harsh weather conditions and helps keep stock securely positioned on your shoulder
- Fits Magpul® Stocks including STR®, ACS™, ACS-L™, and UBR®, MOE® (MAG400) and Com/Mil-Spec CTR® (MAG310).

TACTICAL Recoil Pads



TACTICAL COMFORT

All of our tactical recoil pads make shooting your tactical rifles more comfortable and more accurate.

The LimbSaver AR-15/M4 Snap-On Recoil Pad securely snaps onto most six-position adjustable stocks to reduce felt recoil by up to 60% while reducing muzzle jump. The recoil pad helps increase the accuracy of follow-up shots and you'll enjoy increased control for maximum stability.

ADAPTABLE

The Tac-10 is designed as a drop-in replacement for AR-15 / M4 adjustable rifle stocks utilizing carbine-length buffer tubes. It is engineered with an unheard of ten length-of-pull adjustment positions in increments of one-half inch. The Tac-10 buttstock features two unique dual integral receiver mounting points for standard quick-detach hardware, perfect for right or left hand use. A standard sling attachment point is also included.

A LimbSaver recoil pad is mounted to the Tac-10. It will reduce up to 60% of felt recoil and substantially reduce muzzle jump for heightened accuracy. Its snag-free design won't hinder quick rifle positioning. It truly is an impeccable design. Quick detach hardware not included.

AR-15 RECOIL PAD - TACTICAL SNAP-ON

3/4" THICK PAD

A popular upgrade that fits most mil-spec tactical stocks



AR-15 RECOIL PAD

10019 Black
10020 Tan

FEATURES

- Reduces up to 60% of felt recoil, increase stability for improved control
- Non-slip material helps keep rifle securely positioned against your shoulder; can be used in all harsh weather conditions
- Reduces muzzle jump allowing for faster target re-acquisition
- The easy-to-install pad is made of semi-flexible material which is designed to slip over the stock of the gun without any tools or modifications required



AR-15 ACCESSORY KIT

3-PIECE KIT

This kit includes three products to give you excellent control and heightened accuracy from your tactical rifles

FEATURES

- **A) AR-15 Recoil Pad:** reduces recoil and muzzle jump, and helps keep your rifle securely positioned against your shoulder
*See above for more details
- **B) Tactical Pro Grip:** gives you maximum comfort and grip for a smoother, more controlled shot
*See pages 28-29 for more details
- **C) Sharpshooter X-Ring:** improves your accuracy while dampening barrel whip
*See pages 30-31 for more details



AR-15 ACCESSORY KIT

12007 Black



TAC-10 ADJUSTABLE STOCK

BUTTSTOCK + RECOIL PAD

All the benefits of a LimbSaver recoil pad plus 10 micro-adjustment positions for mil-spec and commercial sized buffer tubes

FEATURES

- Ten adjustable LOP (length of pull) positions in increments of 1/2 inch.
- Forward and rear quick detach points
- Works on both consumer and mil-spec tubes
*Does not fit A1/A2 sized tubes
- LimbSaver® recoil pad reduces felt recoil by up to 60% and also reduces muzzle jump
- Makes no rattle noise while on buffer tube
- Sloping cheek weld for user comfort



TAC-10
12301 Black



SLINGS



Customer Reviews

★★★★★
American Made

This [Kodiak-Lite Sling] is the best sling I've ever purchased. Nice quiet swivels, easily adjustable, stays on your shoulder without the fatigue of other slings and made in USA.

★★★★★

Great!
[The Kodiak-Air is a] good fit for me on my .270. Very comfortable, breathable, and actually fit me. (6'3" 310 lbs). The hand hold is a very nice touch.

★★★★★
A bear of a rifle sling

I field tested the Kodiak-Air sling on my Elk hunt in Idaho. We averaged 6 miles a day hiking. It worked great... We had rain, snow, sleet, and sunshine every day we hunted. The sling stayed on my shoulder even when wet. It dried quickly, stayed pliable with the icy weather. I will be replacing the leather and nylon straps I have on my other rifles with the Kodiak Air.

When you need to carry your rifle, carry it comfortably and securely.

COMPARE OUR SLINGS



KODIAK-AIR Firearm Sling

COMFORT & CUSTOMIZATION
Non-slip, flexible comfort with Adjustable Hand Grip and Universal Quick Detach System



W/ HD Camo Pattern

Standard

KODIAK-LITE Firearm Sling

NON-SLIP COMFORT
Flexible, non-slip design keeps you comfortable with ergonomic hand grip and Standard Detach bracket



W/ HD Camo Pattern

Standard



SW TACTICAL Firearm Sling

MILITARY GRADE MEETS COMFORT
Flexible design with single and dual-point connectors and quick-release clips



FIREARM SLINGS

FLEX AND COMFORT



NON-SLIP, ALL-WEATHER MATERIAL



SECURE ATTACHMENT

KODIAK-AIR: UNIVERSAL QUICK DETACH



KODIAK-LITE: STANDARD ATTACHMENT

SW TACTICAL: SINGLE / DUAL-POINT CONNECTION



SW TACTICAL: QUICK-RELEASE CLIP

COMFORTABLE HAND GRIP

KODIAK-AIR: ADJUSTABLE HAND GRIP



HANDLE SLIDES AND LOCKS IN PLACE

KODIAK-LITE: COMFORTABLE HAND GRIP



UPDATED!

SOFTER, MORE COMFORTABLE GRIP

No longer continuously connected FOR A MORE FLEXIBLE SLING!

KODIAK-AIR

FIREARM SLING

Comfortable, ultra-flexible, lightweight design with premium, locking hand grip and **Universal Quick Detach**



REPOSITIONABLE HAND GRIP!

FEATURES

- Breathable Air-Web pattern with extra-flexible design molds and bends to your body's contours; distributes weight evenly across your shoulder
- Ergonomic, adjustable hand grip provides custom position, comfort, and control and locks securely into place
- Made from LimbSaver's proprietary NAVCOM® technology; non-slip material keeps your firearm in place, even in the rain
- High-strength Universal Quick Detach System locks securely and quickly releases when pin is pressed

COLORS

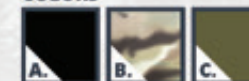

HD PATTERNS

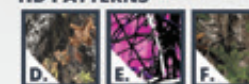

KODIAK-AIR FIREARM SLING

- 12190 Black (A.)
- 12191 Camo (B.)
- 12192 OD Green (C.)
- 12195 Black w/ Mossy Oak Break-Up Infinity® Strap (D.)
- 12196 Black w/ Moon Shine™ Muddy Girl® Strap (E.)
- 12197 Black w/ Realtree Xtra® Green Strap (F.)



KODIAK-LITE

UPDATED FOR 2019 FIREARM SLING

Comfortable, ergonomic sling makes carrying your firearm easy



IMPROVED! SOFTER GRIP and more flexible sling design

FEATURES

- Design helps you carry your firearm comfortably for longer periods by evenly distributing the weight over a larger area
- Made from LimbSaver's proprietary NAVCOM® technology; non-slip material ensures your firearm stays put, even in the rain
- Improved, more comfortable hand grip for added control
- Standard Detach bracket screws on securely to your firearm

COLORS

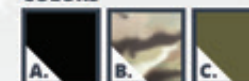

HD PATTERNS

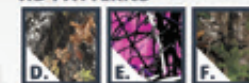

KODIAK-LITE FIREARM SLING

- 12137 Black (A.)
- 12138 Camo (B.)
- 12147 OD Green (C.)
- 12155 Black w/ Mossy Oak Break-Up Infinity® Strap (D.)
- 12156 Black w/ Moon Shine™ Muddy Girl® Strap (E.)
- 12157 Black w/ Realtree Xtra® Green Strap (F.)



SW TACTICAL

FIREARM SLING

Comfortable tactical sling with single/dual-point connection



FEATURES

- Design helps you carry your tactical rifle comfortably for longer periods by evenly distributing the weight of your rifle over a larger area
- Two military-grade quick-connect clasps for single and dual point connection
- Quick release clip allows you to take sling on and off easily without unhooking from rifle
- Made from LimbSaver's proprietary NAVCOM® technology; non-slip material ensures your firearm stays put in all weather conditions
- Adjustable length, ambidextrous design



SW TACTICAL SLING

- 12139 Black
- 12140 Tan
- 12159 Moon Shine™ Camo - Muddy Girl®

COLORS





HANDGUN GRIPS

COMFORT

The Pro Handgun and AR-15 Rifle Grips are designed to provide maximum reduction of muzzle jump and felt recoil for a smoother, more accurate shot.

Multiple impact nodes are located on the inside of the grip, isolating the shooter's hand from the firearm and reducing the pain and discomfort associated with handgun recoil.

It features a protection lip that shields your thumb from the hammer guard contact point during recoil.



FIT

The Pro Grip has a universal-fitting stretch design that conforms to finger grooves and ensures it stays in place during use.

Pro Grips are not recommended for handguns with grip safeties.



★★★★★
Reduced Recoil

I bought this [LimbSaver Pro Grip] after reading reviews of people using it on a Walther PPS 10 MM handgun. It worked much better than my expectations. It made my gun much more stable in the hand while shooting with minimal movement and a much reduced recoil.

PRO HANDGUN GRIP

4 SIZES

Protects your hands and helps you grip your pistol better

FEATURES

- Provides maximum reduction of muzzle jump and felt recoil for smoother, more accurate shot
- Reduces the pain and discomfort associated with firearm recoil
- Made from LimbSaver's proprietary vibration-dampening NAVCOM® material
- Universal-fitting stretch contour design
- Made in USA



PRO GRIP - FULL SIZE

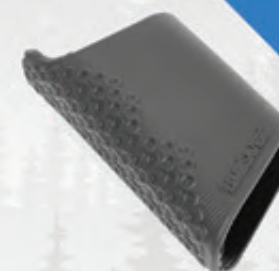

CZ75 Full Size
FN P45/5.7
Desert Eagle & Baby Eagle
Glock G17 / G20 / G21 / G22 / G31 / G34 / G35 / G37 / G40 / G41
Ruger SR9 / SR45 / P85 / P89 / P97 / P512
S&W M&P Full Size / 1006
Sig P220 / P226 / P320
Taurus PT24/7
*May fit additional handguns

FULL SIZE
12020 Black
See page 32 for special order colors!

PRO GRIP - COMPACT



Beretta 92 / 96 / 98 / Px4
CZ75 compact / duty
Glock G19 / G23 / G25 / G32 / G38
HK USP 45 Compact
S&W SD9 / SD40 / Sigma Series
Sig M11A1 / 229 / 228 / 239 / 250 / 2009 / 2022 / 2340
Taurus PT92 / PT99 / PT100 / PT101
*May fit additional handguns

COMPACT
12030 Black
See page 32 for special order colors!

PRO GRIP - SUB COMPACT

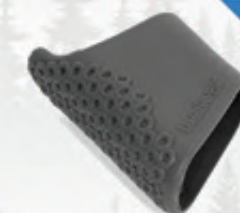

Beretta Nano Bersa Thunder 380
CZ 2075 Rami P
Glock G26 / G27 / G28 / G29 / G30 / G33 / G36 / G39 / G42 / G43
HK P2000SK
Kahr Arms PM9
Ruger SR9C / LC380 / LC9 / LC9s
S&W M&P Shield / Compact / 990L
Taurus PT111 / Millennium
Walther ppk/ppks
*May fit additional handguns

SUB COMPACT
12040 Black
See page 32 for special order colors!

PRO GRIP - TACTICAL



AR-15, M4, M16, AK-47, SCAR, Ruger Mini, P512 22/45, LCP (trim bottom)
*May fit additional tactical rifles and handguns

TACTICAL
12070 Black



SHOOTING ACCESSORIES

TIGHTER GROUPS

The LimbSaver® Sharpshooter X-Ring barrel dampener allows you to tune and minimize the barrel harmonics of your rifle, thereby improving accuracy.

Simply adjusting the position of the X-Ring on the barrel to its "sweet spot" allows the user to achieve sub-MOA (minute of angle) groups with factory ammunition. With the X-Ring, you can dramatically affect the accuracy of your rifle without the need to hand load your own ammunition!



WITHOUT



WITH

SHARP SHOOTER X-RING TIGHTENS GROUPS

★★★★★
Worked great for me!

I have a 22 cal. Cz 452 American that shot best with wolf match extra ammo. Average groups from different lots of wolf was about .5 inch 5 shot groups at 50 yds. Found the sweet spot [for the Sharpshooter X-Ring] and now averages .3 inch groups. Last night it was calm so I tried the gun at 100 yds. Only had time to shoot 2 groups before getting dark. The groups were .62 and .7 inch. I'm sure the groups would have been well over an inch without the de-resonator. I also found the sweet spot on a marlin 17 hmr VS. I was averaging 1.1 inch 100 yd. groups before putting on the X-Ring. With the same box of ammo I averaged .4 inch groups after a little experimentation. This is a great product and for the price you may want to try one on you gun.



Customer Reviews

★★★★★
It works

This [Sharpshooter X-Ring] is a great product. You have to take some time to find the sweet spot. Every rifle will be different. I had a very unruly .22wmr that would not deliver better than a 3" group at 100 yards. After installing and adjusting this product I can now put bullets through the same hole. If you take the time to tune this in it will improve your rifles accuracy.

SHARPSHOOTER X-RING

BARREL
DERESONATOR

Improves accuracy and tightens groups



SHARP SHOOTER X-RING
12051 Standard - Black
12052 Bull Barrel - Black



FEATURES

- Improves accuracy while also dampening barrel whip
- Consistently control muzzle movement during lock-up time for greater accuracy
- Made from LimbSaver's proprietary NAVCOM® material to dampen vibration
- Tunes the vibration waves that affect shot grouping

SIZING:

Available for standard & bull barrels. Bull barrel size also works on scoped slug shotguns.

Standard Size Fits ½" to ¾" Barrel Diameter
Bull Barrel Size Fits ¾" - 1¼" Barrel Diameter

PROTECTIVE SHOOTING PAD

SHOOTING VEST

Easy-to-wear vest protects your shoulder from felt recoil

FEATURES

- Reduces up to 60% of felt recoil to help prevent pain while shooting
- Ideal for those who are especially sensitive to firearm kickback; can be used in addition to LimbSaver recoil pads for maximum protection
- Shoulder pad made from LimbSaver's proprietary NAVCOM® material to reduce felt recoil
- Useful for extended shooting sessions
- Fully adjustable sizing; reversible for right or left-handed shooters
- Built for use in all weather conditions, rain or shine



PROTECTIVE SHOOTING PAD
90102 Black
90100 Additional Protective Shooting Pad Insert (for extra padding)

RIFLE LUBRICANT PEN W/ NEEDLE

GUN OIL

Protects your gear from rust and corrosion, even in the harshest climates



RIFLE LUBRICANT PEN W/ NEEDLE
8005 .25 oz







FEATURES

- It keeps your firearm shooting smoothly and helps prevent rust
- The needle applicator allows you to get the oil in the tightest spots with no mess, saving you cleanup and money
- Cleans all gun parts (and more) while lubricating
- Rifle Lubricant is environmentally safe, non-toxic, non-flammable, odorless, and silicon-free

SPECIAL ORDER

Items marked with an "SO" suffix are available items but may require additional processing time. Please allow for the possibility of an additional 2 weeks for processing and shipping.

PART NUMBER	DESCRIPTION	
10534 SO	Trap Grind-To-Fit - Small (1" Thick/LOP)	
10535 SO	Trap Grind-To-Fit - Medium (1" Thick/LOP)	
10536 SO	Trap Grind-To-Fit - Large (1" Thick/LOP)	
10537 SO	Nitro Grind-To-Fit - Small (1 1/2" Thick/LOP)	
10538 SO	Nitro Grind-To-Fit - Medium (1 1/2" Thick/LOP)	
10539 SO	Nitro Grind-To-Fit - Large (1 1/2" Thick/LOP)	

PART NUMBER	DESCRIPTION	
12022 SO	Full Frame - Blue	
12023 SO	Full Frame - Green	
12024 SO	Full Frame - Purple	
12025 SO	Full Frame - Pink	
12026 SO	Full Frame - Red	
12029 SO	Full Frame - Tan	
12032 SO	Compact - Blue	
12033 SO	Compact - Green	
12034 SO	Compact - Purple	
12035 SO	Compact - Pink	
12036 SO	Compact - Red	
12039 SO	Compact - Tan	
12042 SO	Sub-Compact - Blue	
12043 SO	Sub-Compact - Green	
12044 SO	Sub-Compact - Purple	
12045 SO	Sub-Compact - Pink	
12046 SO	Sub-Compact - Red	
12049 SO	Sub-Compact - Tan	

PART NUMBER	DESCRIPTION	
3282 SO	Kodiak-Air Treestand Sling - Black	
3283 SO	Kodiak-Air Treestand Sling - Camo	
3289 SO	Kodiak-Air Treestand Sling - OD Green	

HD PATTERNS AND COLORS

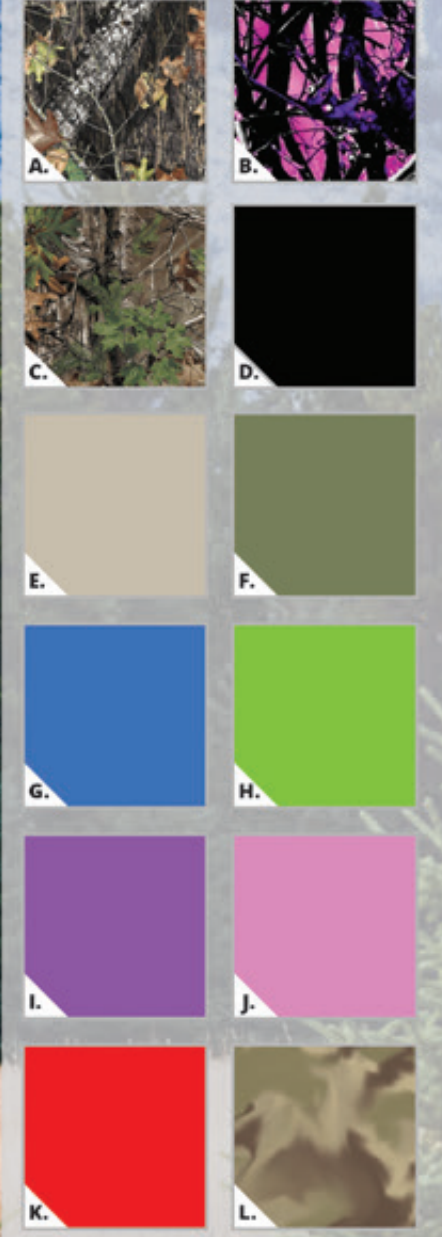

Mossy Oak Break-Up Infinity® (A.)
Moon Shine™ Camo - Muddy Girl® (B.)
Realtree Xtra® Green (C.)
Black (D.)
Tan (E.)
OD Green (F.)
Blue (G.)
Green (H.)
Purple (I.)
Pink (J.)
Red (K.)
Standard Camo (L.)



RECOIL PAD FITTING GUIDE

MEASUREMENTS FOR GRIND-TO-FIT RECOIL PADS

Please also use our templates to ensure proper fit.

*All Grind-to-Fit® pads are designed for flat butt stocks

SIZE	MEASUREMENTS	MODEL
CLASSIC GRIND-TO-FIT®: (Flat butt stocks only. 1" thick)		
S	4 13/16" X 1 27/32" Grindable To: 3 7/8" X 1 13/32"	10541
M	5 3/32" X 1 13/16" Grindable To: 4 3/4" X 1 5/16"	10542
L	5 9/16" X 2 1/16" Grindable To: 4 7/16" X 1 19/32"	10543
LOW PROFILE GRIND-TO-FIT®: (Flat butt stocks only. 5/8" thick)		
Med+	5 1/2" X 1 33/32" Grindable To: 3 28/32" X 1 13/32" (5/8" Thick)	10544
NITRO GRIND-TO-FIT®: (Flat butt stocks only. 1 1/2" thick)		
S	4 13/16" X 1 27/32" Grindable To: 3 7/8" X 1 13/32"	10537
M	5 3/32" X 1 13/16" Grindable To: 4 3/4" X 1 5/16"	10538
L	5 9/16" X 2 1/16" Grindable To: 4 7/16" X 1 19/32"	10539
TRAP / SKEET GRIND-TO-FIT®: (Flat butt stocks only. 1" thick) Curved/Contoured Design		
S	4 13/16" X 1 27/32" Grindable To: 3 7/8" X 1 13/32"	10534
M	5 3/32" X 1 13/16" Grindable To: 4 3/4" X 1 5/16"	10535
L	5 9/16" X 2 1/16" Grindable To: 4 7/16" X 1 19/32"	10536
SPEED MOUNT GRIND-TO-FIT®: (Flat butt stocks only. 1" thick) Sloped design.		
Med+	5 1/2" X 1 33/32" Grindable To: 3 28/32" X 1 13/32"	10540

MEASUREMENTS FOR SLIP-ON RECOIL PADS

SIZE	MEASUREMENTS	MODEL
CLASSIC SLIP-ON RECOIL PAD: (Universal. Approx. 1" thick unless otherwise noted.)		
S	4 1/2" X 1 1/2" Up to 4 13/16" X 1 5/8"	10546
S/M	4 5/8" X 1 1/16" Up to 5 1/8" X 1 3/4" (1/2" thick)	10545
M	4 13/16" X 1 5/8" Up to 5 3/8" X 1 3/4"	10547
L	5 1/8" X 1 3/4" Up to 5 5/8" X 1 7/8"	10548
AIR-TECH® SLIP-ON RECOIL PAD: (Universal. Approx. 1" thick unless otherwise noted.)		
S	4 1/2" X 1 1/2" Up to 4 13/16" X 1 5/8"	10550
S/M	4 5/8" X 1 1/16" Up to 5 1/8" X 1 3/4" (1/2" thick)	10549
M	4 13/16" X 1 5/8" Up to 5 3/8" X 1 3/4"	10551
L	5 1/8" X 1 3/4" Up to 5 5/8" X 1 7/8"	10552

PRECISION-FIT RECOIL PAD CROSS REFERENCE GUIDE

Find your make and model below to find the corresponding LimbSaver® Recoil Pad product number.

*Due to manufacturers' stock deviations, LimbSaver Precision-Fit Recoil Pads are not a guaranteed fit.

Please also use our templates to ensure proper fit.

*All Precision-Fit and Grind-to-Fit® pads are designed for flat butt stocks (unless specified)

*All pads, unless specified, are approximately 1" in thickness.

*Precision-Fit pads are not intended to be ground.

SYNTHETIC STOCKS

MAKE	MODEL	STOCK	AIRTECH®	CLASSIC
Benelli	Sport 1	Synthetic	10810	10401
Benelli	Sport II	Synthetic	10810	10401
Benelli	Nova	Synthetic	10810	10401
Benelli	SBE I	Synthetic	10810	10401
Benelli	SBE II	Synthetic	10810	10401
Benelli	Super Sport	Synthetic	10810	10401
Benelli	MII	Synthetic	10810	10401
Benelli	Cordoba 12/20ga	Synthetic	10810	10401
Benelli-Tactical	Pistol Grip Stock SBE MII (12ga) Pop-in pad	Synthetic		10404
Benelli-Tactical	Pistol Grip Stock Nova	Synthetic		10404
Benelli-Tactical	Pistol Grip Stock Super Sport Pop-in pad	Synthetic		10404
Benelli-Tactical	Pistol Grip Stock MII 12ga Pop-in pad	Synthetic		10404
Benelli-Tactical	Pistol Grip Stock Super Sport Bolt-On	Synthetic		10403
Benelli-Tactical	Pistol Grip Stock M1 Bolt-On	Synthetic		10403
Benelli-Tactical	Pistol Grip Stock SBE Bolt-On	Synthetic		10403
Benelli	M2 21VR W/ Comfort-Tech Stock	Synthetic	10810	10401
Benelli	Super Vinci W/ Comfort-Tech Stock	Synthetic	10810	10401
Benelli	M1/M4 with NOVESKEADAPTER	Synthetic	10807	10111
Beretta	A300 Outlander	Synthetic	10817	10702
Beretta	A400 Extreme	Synthetic	10817	10702
Beretta	Extrema2 with Kick Off stock-12ga- TX4 Storm	Synthetic	10817	10702
Beretta	Sporting/Competition e.g. DT11-692	Synthetic	10811	10701
Blackhawk	SpecOps Gen II	Synthetic	10811	10701
Blackhawk	Axiom Ultra Light	Synthetic	10811	10701
Blackhawk	Axiom Thumb Hole	Synthetic	10811	10701
Blaser	R8 (5/8" thick pad)	Synthetic		10818
Blaser	R93 Professional Camo Bolt on only (5/8" thick pad)	Synthetic		10012
Blaser	R93 Dark Green Bolt on only (5/8" thick pad)	Synthetic		10012
Blaser	R93 Professional Black Bolt on only (5/8" thick pad)	Synthetic		10012
Browning	Gold 12 * 20ga only.	Synthetic		10008
Browning	Silver Hunter 12ga	Synthetic		10008
Browning	Silver 12/20 GA	Synthetic		10008
Browning	A-Bolt Stainless Stalker	Synthetic	10801	10002
Browning	BPS 10ga.	Synthetic		10301
Browning	X-Bolt Rifles	Synthetic	10814	
Browning	AB3 (A-Bolt 3) Rifles	Synthetic	10814	
Choate	ALL stocks that use the mark5 Spacer System	Synthetic	10812	
Christensen Arms	Carbon Summit Rifle	Synthetic	10805	10101
Christensen Arms	Carbon Classic Rifle	Synthetic	10805	10101
Colt	LE6920 Series	Synthetic		10019
Colt	LE6920 Law Enforcement 30+1 223REM/5.56NATO	Synthetic		10019
Colt	LE6940 Series	Synthetic		10019
DPMS	GII AP4	Synthetic		10019
Franchi	Verimax 912 12ga	Synthetic	10810	10401
Harrington/Richards	Handi-Rifle, Adult synthetic - Straight/ Monte Carlo	Synthetic		10018
Knight	50cal. Disc Inline ML	Synthetic	10801	10002
Magpul	MOE-SL Carbine (5/8"-thick pad)	Synthetic		10829
Magpul	ACS Mag 370/371 (5/8"-thick pad)	Synthetic		10025
Magpul	CTR Mag 310/311 (5/8"-thick pad)	Synthetic		10025
Magpul	ACS-L Mag 378/379 (5/8"-thick pad)	Synthetic		10025
Magpul	CTR Mag 310/311 (5/8"-thick pad)	Synthetic		10025
Magpul	MOE Mag 400/401 (5/8"-thick pad)	Synthetic		10025
Magpul	STR Mag 470/471 (5/8"-thick pad)	Synthetic		10025
Magpul	UBR Collapsible Stock Mag 330- Mil-Spec	Synthetic		10025
Magpul	SGA Stocks with the SGA with Adapter	Synthetic	10805	10101
Marlin	Model XS7	Synthetic	10805	10101
Mossberg	500A	Synthetic	10809	10201
Mossberg	535	Synthetic	10809	10201
Mossberg	695	Synthetic	10809	10201
Mossberg	835	Synthetic	10809	10201

PRECISION-FIT RECOIL PAD CROSS REFERENCE GUIDE

PRECISION-FIT RECOIL PAD CROSS REFERENCE GUIDE

Find your make and model below to find the corresponding LimbSaver® Recoil Pad product number.
 *Due to manufacturers' stock deviations, LimbSaver Precision-Fit Recoil Pads are not a guaranteed fit.
 Please also use our templates to ensure proper fit.
 *All Precision-Fit and Grind-to-Fit® pads are designed for flat butt stocks (unless specified)
 *All pads, unless specified, are approximately 1" in thickness.
 *Precision-Fit pads are not intended to be ground.

Find your make and model below to find the corresponding LimbSaver® Recoil Pad product number.
 *Due to manufacturers' stock deviations, LimbSaver Precision-Fit Recoil Pads are not a guaranteed fit.
 Please also use our templates to ensure proper fit.
 *All Precision-Fit and Grind-to-Fit® pads are designed for flat butt stocks (unless specified)
 *All pads, unless specified, are approximately 1" in thickness.
 *Precision-Fit pads are not intended to be ground.

SYNTHETIC STOCKS

MAKE	MODEL	STOCK	AIRTECH®	CLASSIC
Mossberg	590 A1	Synthetic	10809	10201
Mossberg	590SP 12ga	Synthetic	10809	10201
Mossberg	930 (NON SPX)	Synthetic	10809	10201
Mossberg	935 NON-Pistol Grip	Synthetic	10809	10201
Mossberg	Maverick 88 12ga	Synthetic	10809	10201
Mossberg	Maverick 88 20ga	Synthetic	10807	10111
Mossberg	ATI pistol grip non-tactical	Synthetic	10802	10003
Mossberg	MOE 590A1 with SGA Adapter	Synthetic	10805	10101
Mossberg	International™ 715T™	Synthetic		10019
Mossberg	500 - ATI Tactical	Synthetic		10019
Mossberg	All 4 3/4" buttstocks	Synthetic		10121
Remington	700 SPS	Synthetic	10805	10101
Remington	700 ADL	Synthetic	10805	10101
Remington	700 BDL	Synthetic	10805	10101
Remington	700 LVSF	Synthetic	10816	10601
Remington	700 ML	Synthetic	10805	10101
Remington	710	Synthetic	10805	10101
Remington	770	Synthetic	10805	10101
Remington	870	Synthetic	10805	10101
Remington	870 Express	Synthetic	10805	10101
Remington	870 Express Tactical	Synthetic	10805	10101
Remington	1100 Competition	Synthetic	10805	10101
Remington	1100 Tactical 12/22 OD-Green	Synthetic	10805	10101
Remington	11-87	Synthetic	10805	10101
Remington	7600	Synthetic	10805	10101
Remington	SP-10	Synthetic	10805	10101
Remington	VTR Centerfire	Synthetic	10805	10101
Remington	870 Magnum Special Purpose	Synthetic	10806	10102
Remington	Titanium	Synthetic	10816	10601
Ruger	American	Synthetic	10825	
Ruger	American Magnum	Synthetic	10825	
Ruger	American Predator	Synthetic	10825	
Ruger	American LH	Synthetic	10825	
Ruger	American All Weather	Synthetic	10825	
Ruger	American Crossfire	Synthetic	10825	
Ruger	American Ranch	Synthetic	10825	
Ruger	American Compact	Synthetic	10824	
Ruger	American All Weather Compact	Synthetic	10824	
Ruger	M77	Synthetic	10800	10001
Ruger	Hawkeye	Synthetic	10800	10001
Ruger	77, Mark II, Factory Skeleton Stock-(Request Adapter from us)	Synthetic	10803	10011
Sako	75	Synthetic	10803	10011
Sako	Finnlight	Synthetic	10803	10011
Savage	93 R-AC-TR	Synthetic		10301
Savage	A17	Synthetic	10808	10112
Smith & Wesson	M&P®15T Tactical with M-LOK®	Synthetic		10019
Smith & Wesson	M&P®15 1 in 7" Twist	Synthetic		10019
Smith & Wesson	M&P 15 Sport II 5.56 NATO 16" 30+1	Synthetic		10019
Stag Arms	AR-15 Model 1	Synthetic		10019
Stag Arms	AR-15 Model 1L	Synthetic		10019
Stag Arms	AR-15 Model 2	Synthetic		10019
Stag Arms	AR-15 Model 2L	Synthetic		10019
Stag Arms	AR-15 Model 2T	Synthetic		10019
Stag Arms	AR-15 Model 2TL	Synthetic		10019
Stag Arms	AR-15 Model 3	Synthetic		10019
Stoeger	M3000	Synthetic	10823	
Stoeger	3500	Synthetic	10823	
Stoeger	M2000 (No Pistol Grip)	Synthetic		10008
Stoeger	P-350 Pump	Synthetic		10008

SYNTHETIC STOCKS

MAKE	MODEL	STOCK	AIRTECH®	CLASSIC
Tapco	AK T6™ Stock	Synthetic		10019
Tapco	Mil-Spec Profile AR T6™	Synthetic		10019
Tapco	INTRAFUSE T6 AK-47 Collapsible Stock for Stamped Receiver	Synthetic		10019
Thomp Ctr Arms	Triumph	Synthetic	10804	10031
Thomp Ctr Arms	Triumph Bone Collector	Synthetic	10804	10031
Thomp Ctr Arms	Pro Hunter	Synthetic	10804	10031
Thomp Ctr Arms	Pro Hunter Predator	Synthetic	10804	10031
Thomp Ctr Arms	Pro Hunter FX	Synthetic	10804	10031
Thomp Ctr Arms	Pro Hunter Turkey	Synthetic	10804	10031
Thomp Ctr Arms	Pro Hunter Shotgun Slug	Synthetic	10804	10031
Thomp Ctr Arms	Venture	Synthetic	10804	10031
Thomp Ctr Arms	Encore Pro Hunter	Synthetic	10804	10031
Thomp Ctr Arms	Omega ML	Synthetic	10804	10031
Thomp Ctr Arms	Black Diamond	Synthetic	10804	10031
Tikka	T3X	Synthetic	10826	
Tikka	T3 Lite Adjustable	Synthetic	10803	10011
Tikka	T3 Battue Lite Rifle 30.06, 9.3x62	Synthetic	10803	10011
Weatherby	PA-08 12ga	Synthetic	10807	10111
Winchester	Model 1300	Synthetic		10301
Winchester	Model 70 Super Shadow - 4 3/4"	Synthetic	10816	10601

WOOD STOCKS

MAKE	MODEL	STOCK	AIRTECH®	CLASSIC
Benelli	Super Black Eagle 12ga	Wood	10810	10401
Benelli	20ga Ultralight Satin Walnut with WeatherCoat™	Wood	10810	10401
Beretta	A300 Outlander	Wood	10817	10702
Beretta	A400 Excel	Wood	10817	10702
Beretta	690 Sporting W/ Kick Off	Wood	10817	10702
Beretta	692 Sporting W/ Kick Off	Wood	10817	10702
Beretta	Sporting/Competition e.g. DT11-692	Wood	10811	10701
Browning	BPS Upland 20ga	Wood	10815	10030
Browning	BPS Upland 12ga	Wood	10801	10002
Browning	X-Bolt Rifles	Wood	10814	
Browning	AB3 (A-Bolt 3) Rifles	Wood	10814	
Franchi	Alcoine 12 ga	Wood	10800	10001
Harrington/Richards	SB2-988 Slug Hunter	Wood/Lam	10802	10003
Harrington/Richards	Ultra Slug Hunter (pad screw hole modification)	Wood	10816	10601
Mossberg	Mossberg 500 12ga with Wood Stock (Model: 54264)	Wood	10816	10601
Mossberg	100ATR Rifle White Tail Lightening	Wood	10809	10201
Remington	750	Wood	10806	10102
Remington	870 Wing Master (non-Express)	Wood	10806	10102
Remington	870 Police-12/18/20ga	Wood	10806	10102
Remington	1100 G3	Wood	10806	10102
Remington	Model 1187 SP 1992 yr - 35 Whelen	Wood	10806	10102
Remington	1187 4/7	Wood	10808	10112
Remington	1100 2/5	Wood	10808	10112
Remington	7 CDL	Wood	10808	10112
Remington	673 guide gun	Wood	10808	10112
Remington	700 DM	Wood	10808	10112
Sako	75	Wood	10803	10011
Thomp Ctr Arms	Encore Pro Hunter	Wood	10815	10030
Thomp Ctr Arms	Thunderhawk 50cal	Wood	10806	10102
Thomp Ctr Arms	Omega ML	Wood	10815	10030
Thomp Ctr Arms	Black Diamond	Wood	10815	10030
Tikka	T3X	Wood	10826	
Tikka	T3 Lite - all models except T3 Sporter	Wood	10803	10011
Winchester	Model 12 Heavy Duck 12ga.	Wood	10808	10112

RECOIL PAD TEMPLATES

WHY WE RECOMMEND USING TEMPLATES:

Many manufacturers modify their stock dimensions yearly, making it difficult for us to keep one specific model available for one specific manufacturer. You may also have a less common gun that we do not list in our Recoil Pad Reference Guide, but you may find a pad that works great. For those reasons we have provided these templates to help you match your buttstock.

OTHER OPTIONS:

If you have a stock that one of our [Precision-Fit Recoil Pads](#) will not fit, you can utilize our [SLIP-ON Recoil Pads](#) which deliver the same felt recoil reduction as the Precision-Fit Pad. Removal of existing pad is recommended, but not required. You may also utilize our [GRIND-TO-FIT® Recoil Pads](#), but these may require a visit to your local gunsmith.

TEMPLATE INSTRUCTIONS:

Simply remove the existing recoil pad or plate from your butt stock by unscrewing. If your recoil pad is glued on, it may require gunsmithing.

Place the gun stock on top of each template until you have found a match. Cut template out and place on stock to check for perfect fit and to determine screw hole location. If the screw holes do not line up, you can slot or elongate the screw holes on the bottom of our plate an additional 3/16" or more towards the heel or the toe and 1/16" towards the center of the pad (use a Dremel® tool with sanding attachment) to match the holes in your stock. This is regardless of wood or synthetic stocks. Please note: This only refers to the template recoil pads that are not already elongated or slotted.

Once a match is found, the product number will be on that specific template so you will know which one to order.

PRECISION-FIT RECOIL PAD TEMPLATES

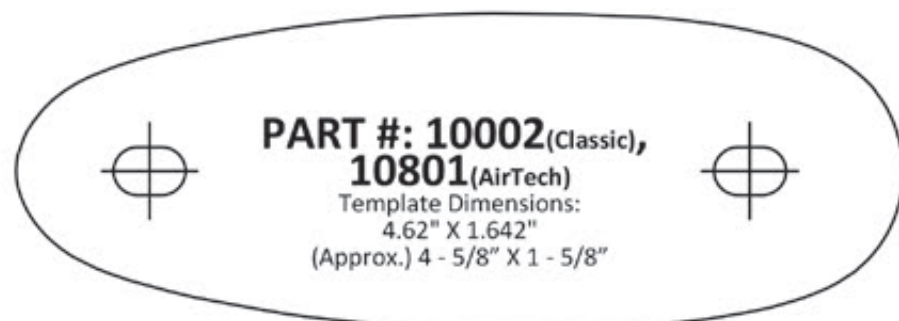
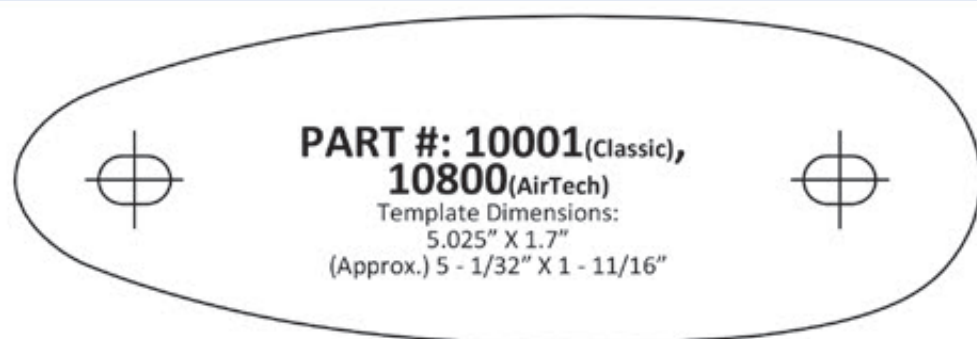

PRECISION-FIT RECOIL PAD TEMPLATES

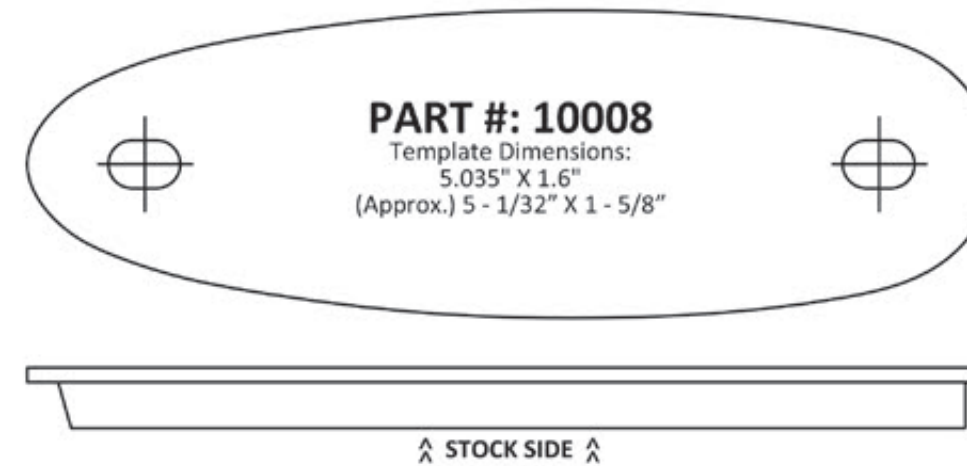
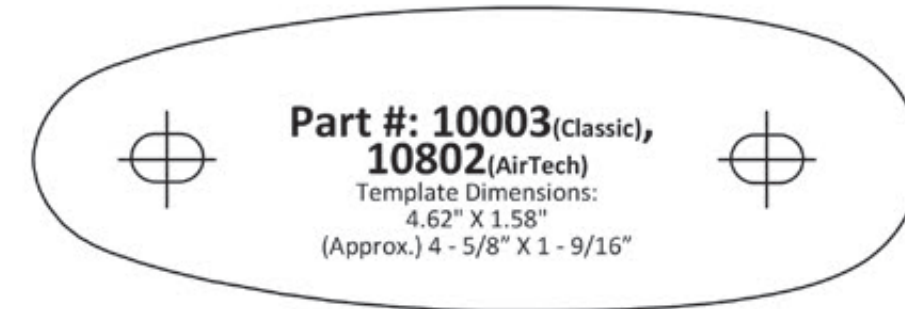

+ This pad fits a specific make of synthetic stock. To accomplish as accurate a fit as possible, many of the synthetic recoil pad plates have profiles that snap inside the cavities of the stock. While most plates can be altered by grinding off protruding plastic on the plate, this plate CANNOT be altered.

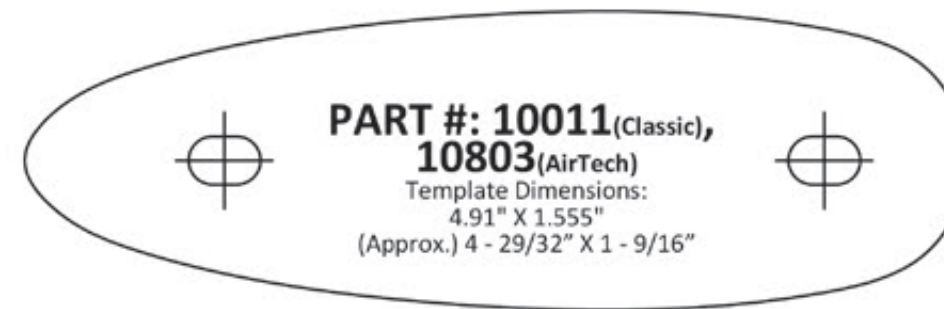

+ Contact LimbSaver® for free adaptor plate to fit Ruger Skeleton.

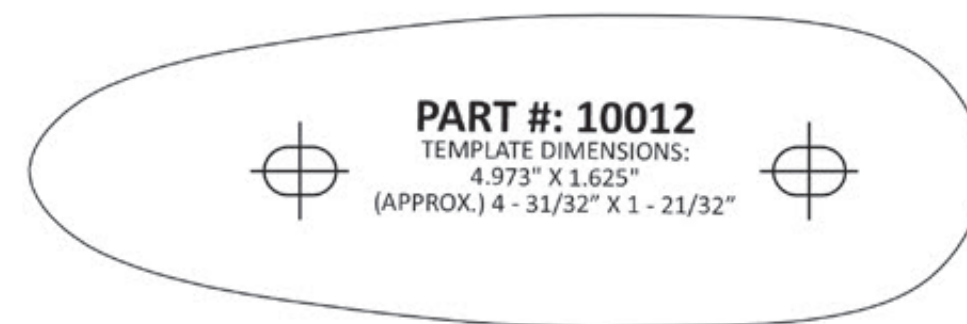

PRECISION-FIT RECOIL PAD TEMPLATES

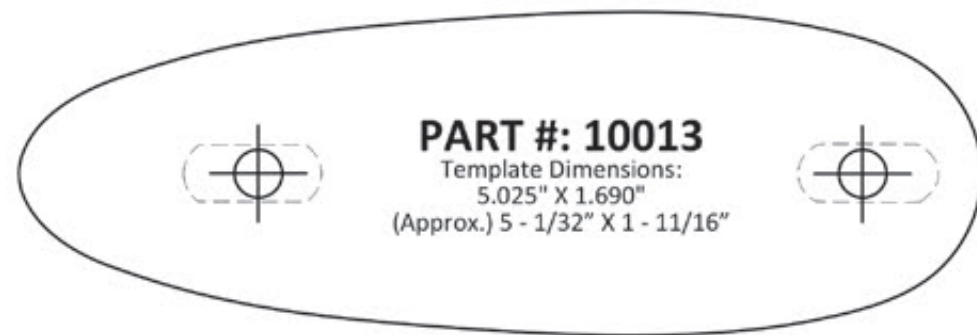

TACTICAL STOCK RECOIL PADS

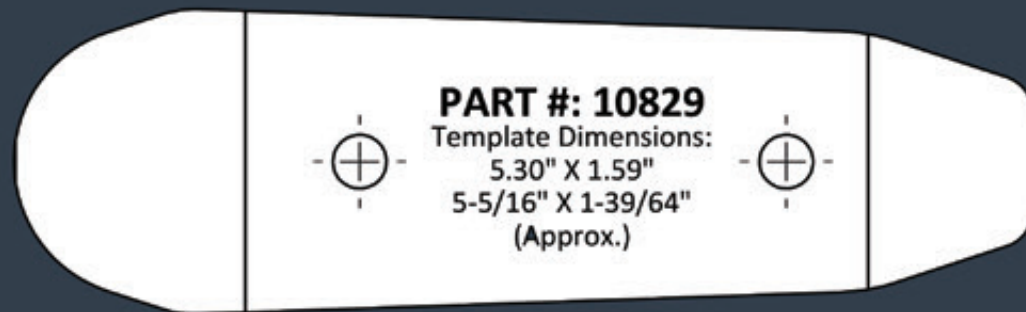

+ For Magpul stocks only

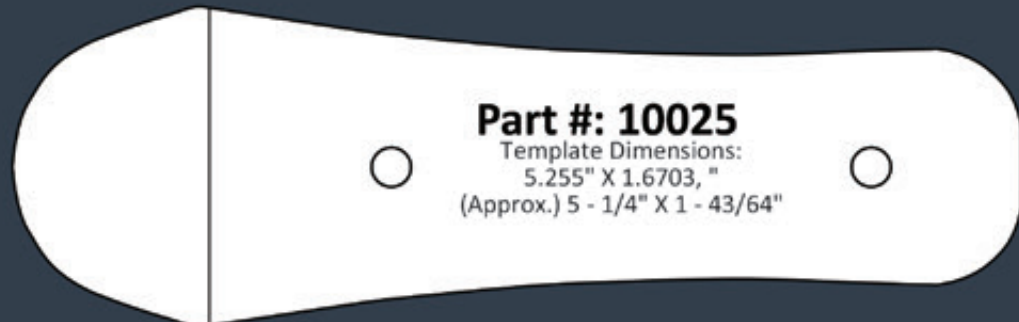

+ For Magpul stocks only

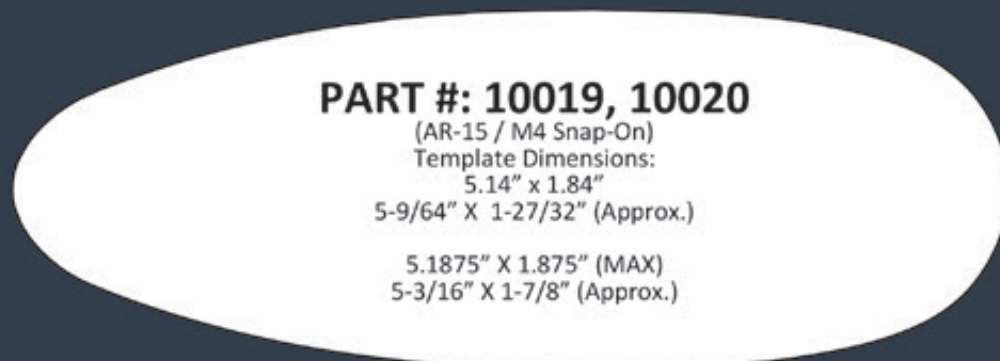

+ AR-15 pad is for most 6 Position tactical stocks. NO SCREW HOLES.

PRECISION-FIT RECOIL PAD TEMPLATES

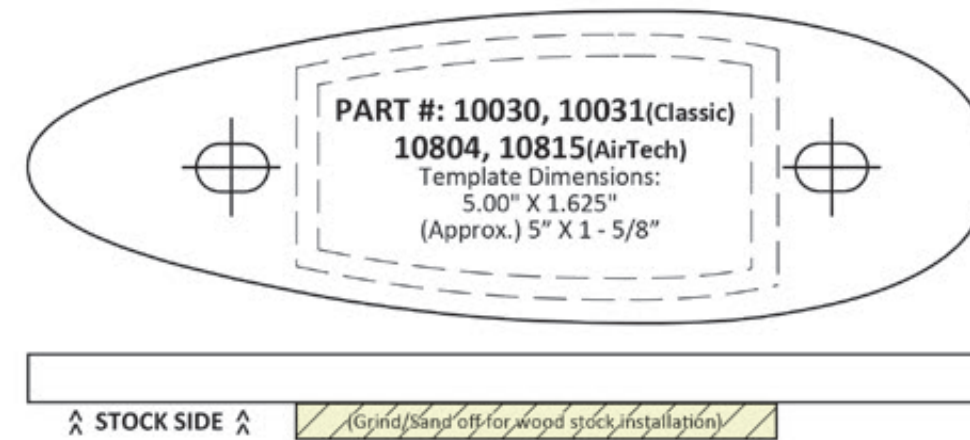
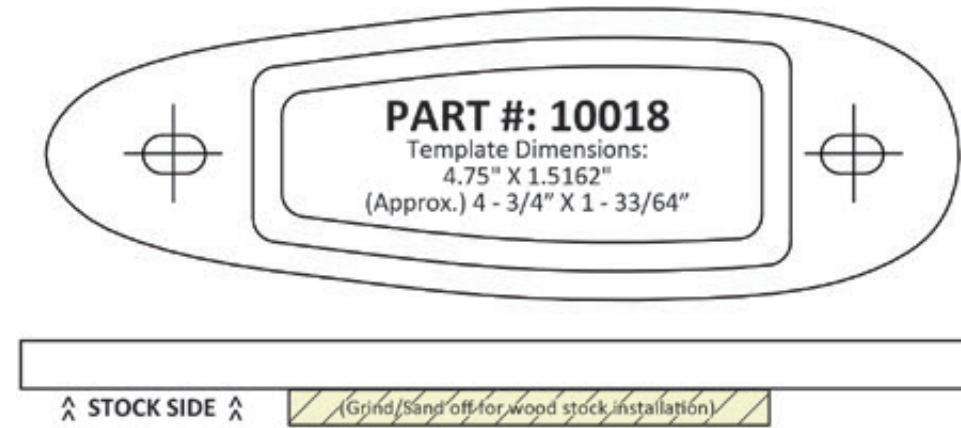

+ 10030/10815: for wood stocks only

+ 10031/10804: for synthetic stocks only

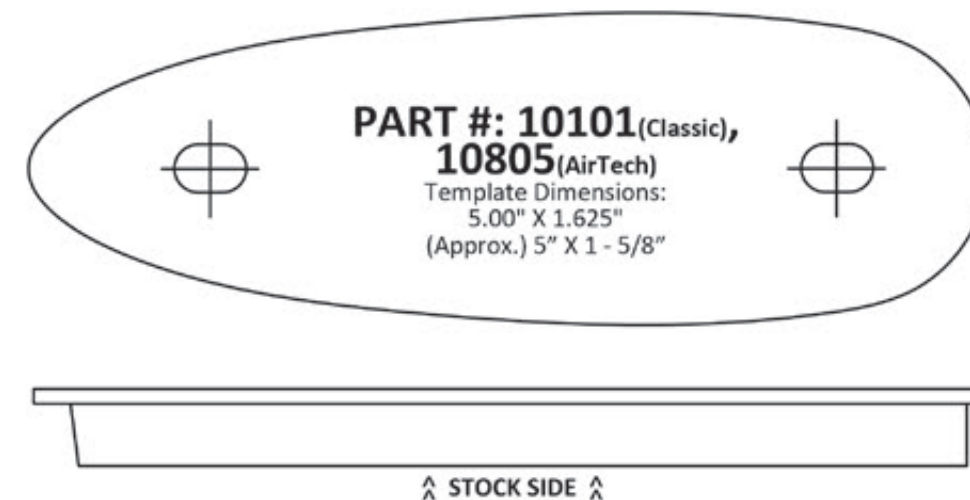

+ This pad fits a specific make of synthetic stock. To accomplish as accurate a fit as possible, many of the synthetic recoil pad plates have profiles that snap inside the cavities of the stock. While most plates can be altered by grinding off protruding plastic on the plate, this plate CANNOT be altered.

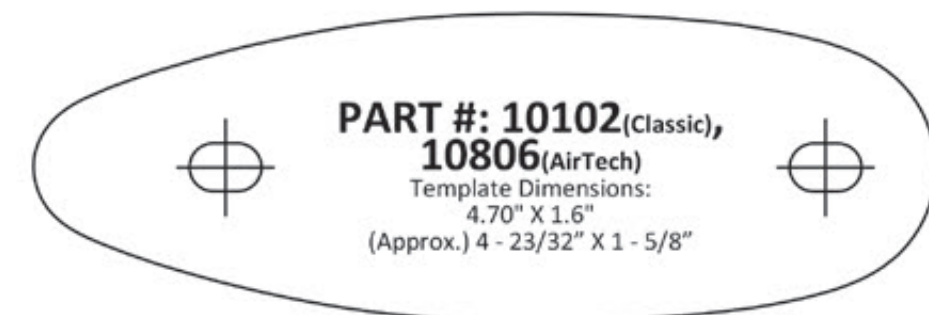

PRECISION-FIT RECOIL PAD TEMPLATES

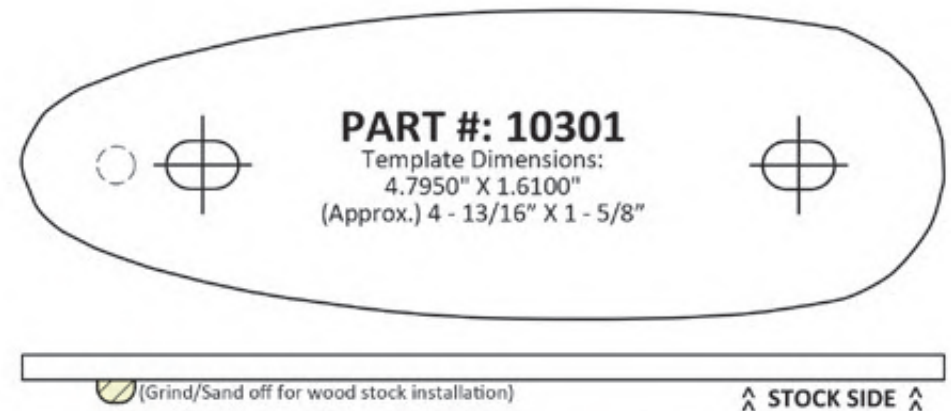
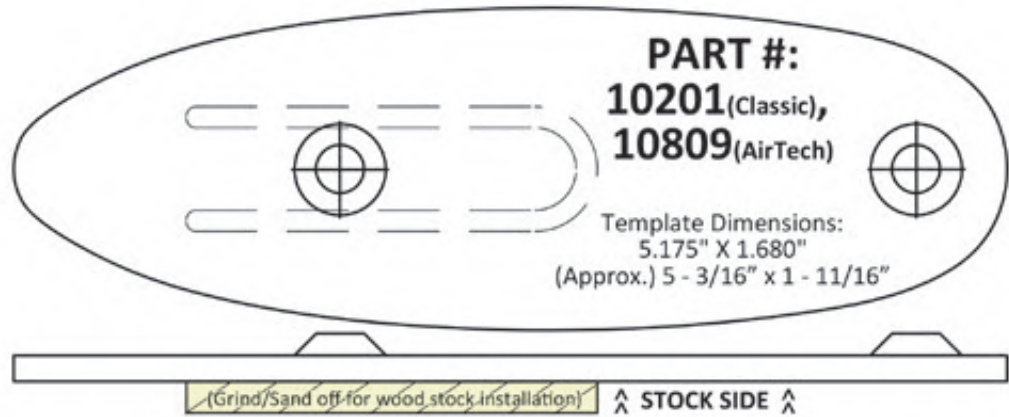
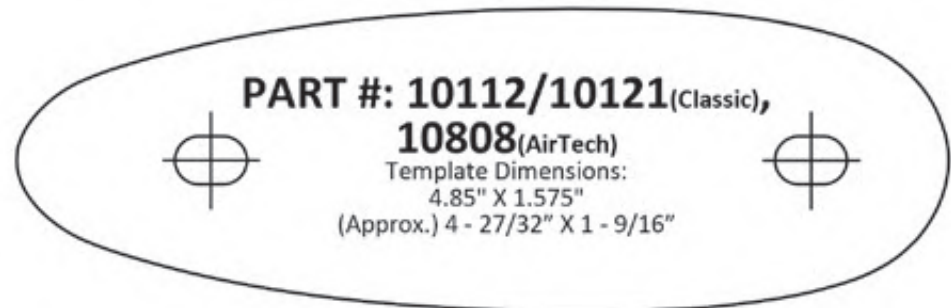
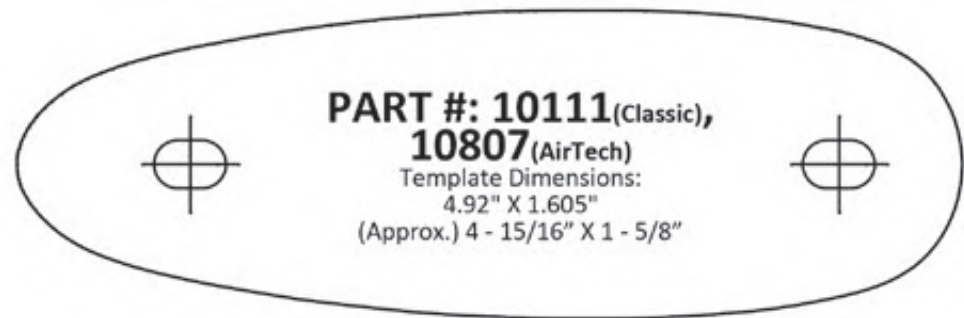

PRECISION-FIT RECOIL PAD TEMPLATES

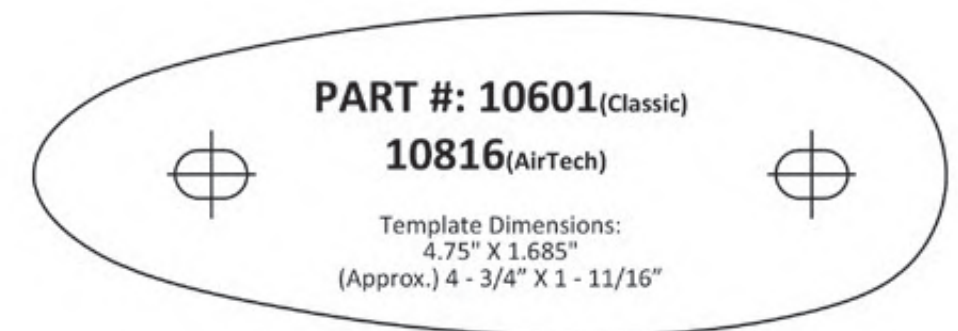
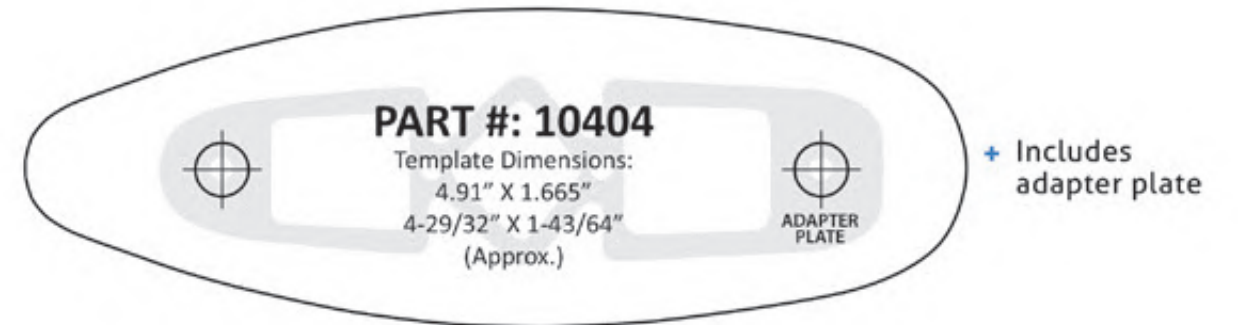
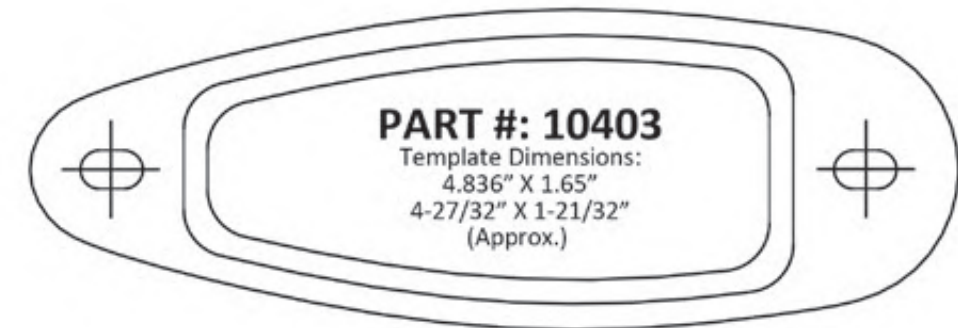
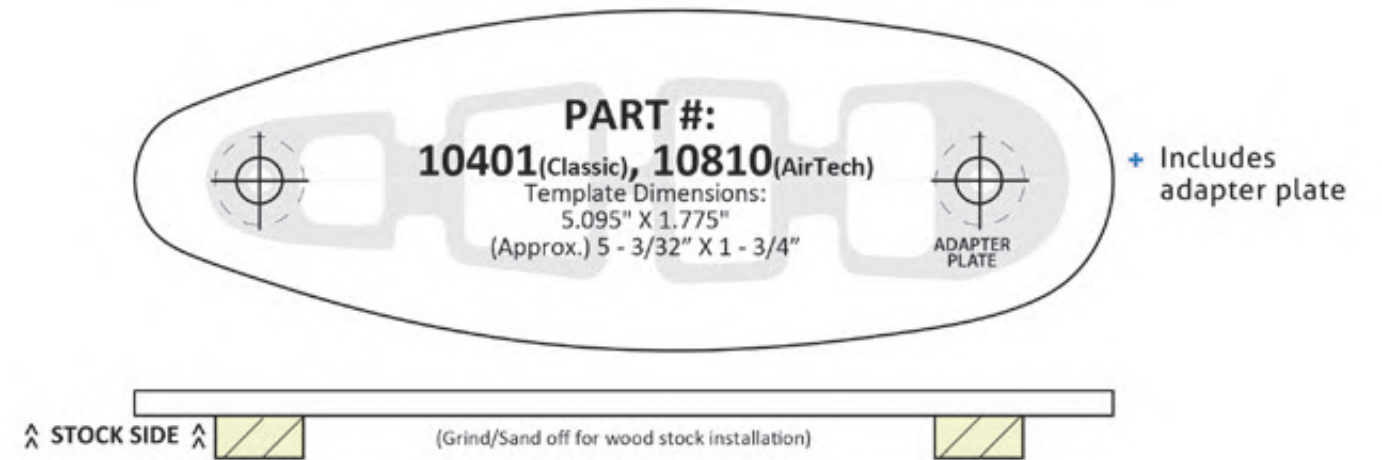

PRECISION-FIT RECOIL PAD TEMPLATES

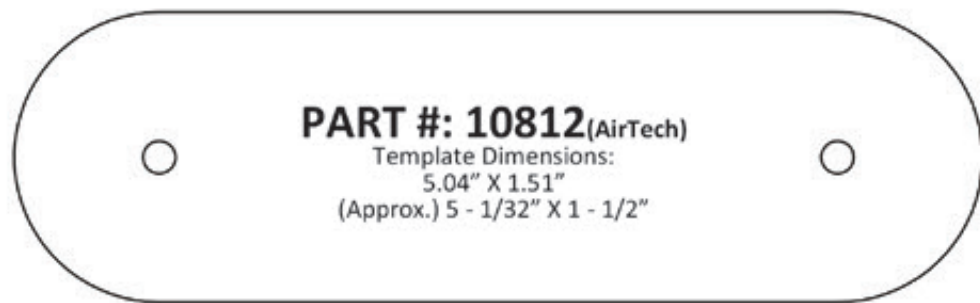
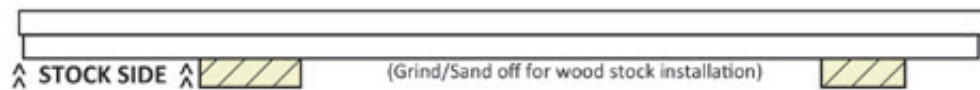
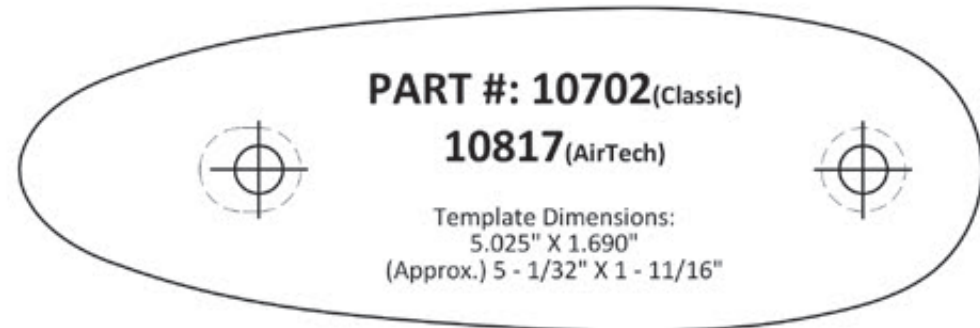
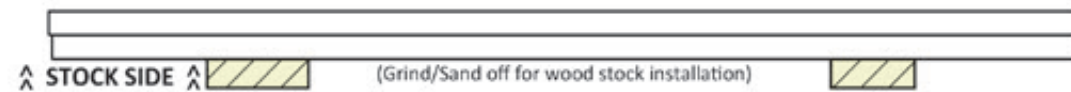
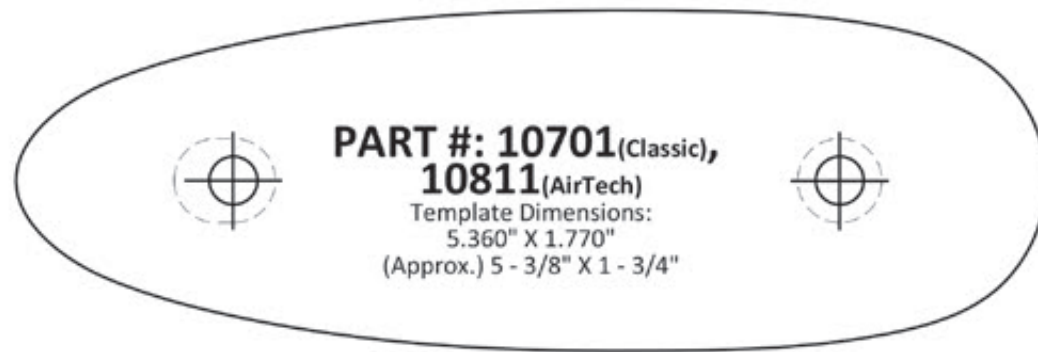

PRECISION-FIT RECOIL PAD TEMPLATES

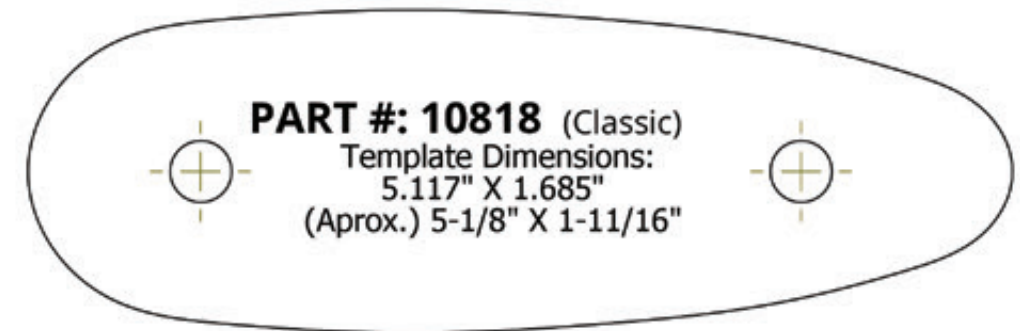

+ This pad is only 5/8" thick

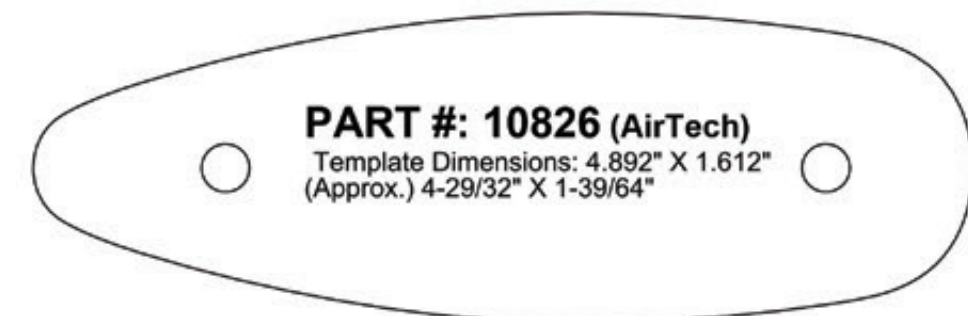
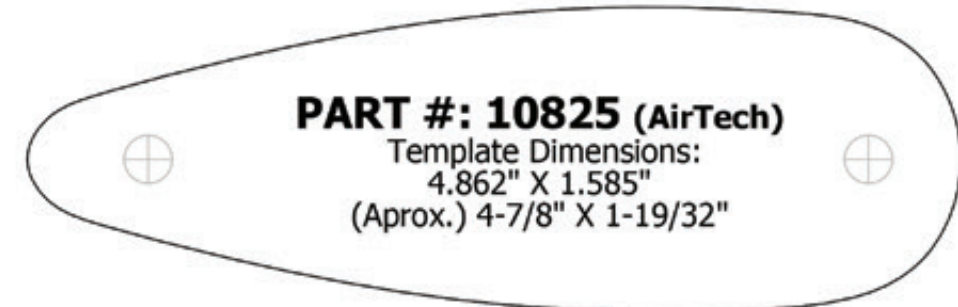
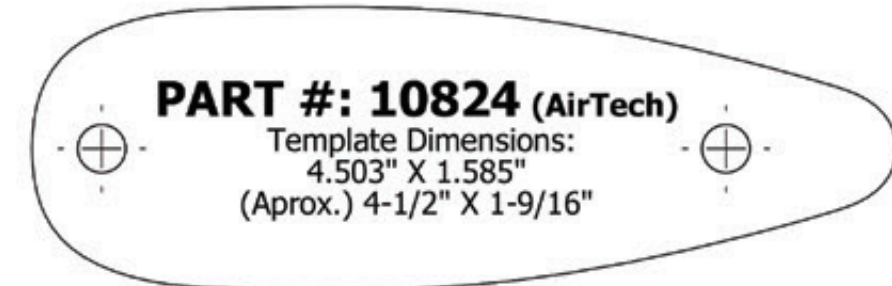
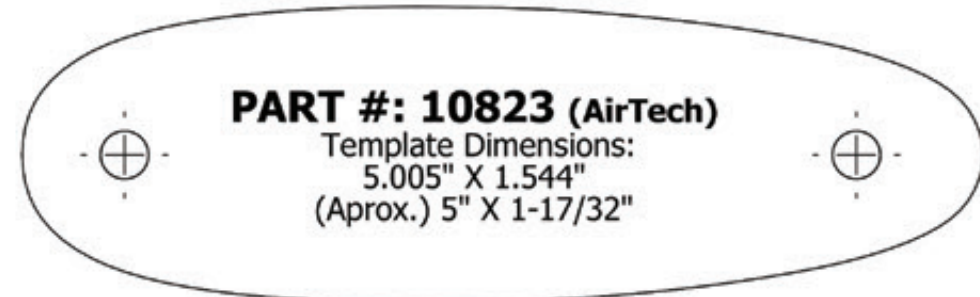

About Grind-to-Fit® Recoil Pads

The following Grind-to-Fit® Recoil Pads are shown with two profile lines. The outer line is the actual size of the pad. The inner line is the "Max" Grind line. In order for our technology to function properly, the interior air chamber must remain intact with enough wall thickness to contain the pressure during the firing of the weapon. By not grinding past this line, you ensure your pad will be in perfect working order.

To determine which Grind-to-Fit® Recoil Pad is right for you, remove your existing pad, and place your flat stock on the templates. Choose the pad that shows the full outer line of the template, and none of the interior line. For further instructions, go to www.LimbSaver.com.

Small

- 10541 - Classic - 1" thick
- 10534 - Trap - 1" thick
- 10537 - Nitro - 1½" thick

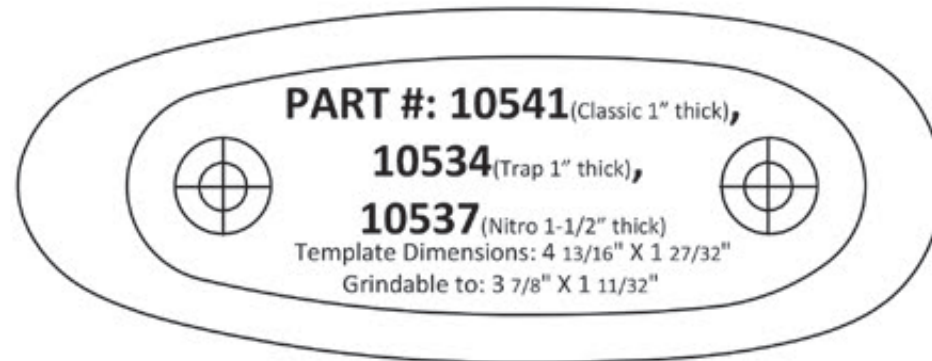

Medium

- 10542 - Classic - 1" thick
- 10535 - Trap - 1" thick
- 10538 - Nitro - 1½" thick



Medium Plus

- 10540 - Speed Mount® - 1" thick
- 10544 - Classic - 5/8" thick

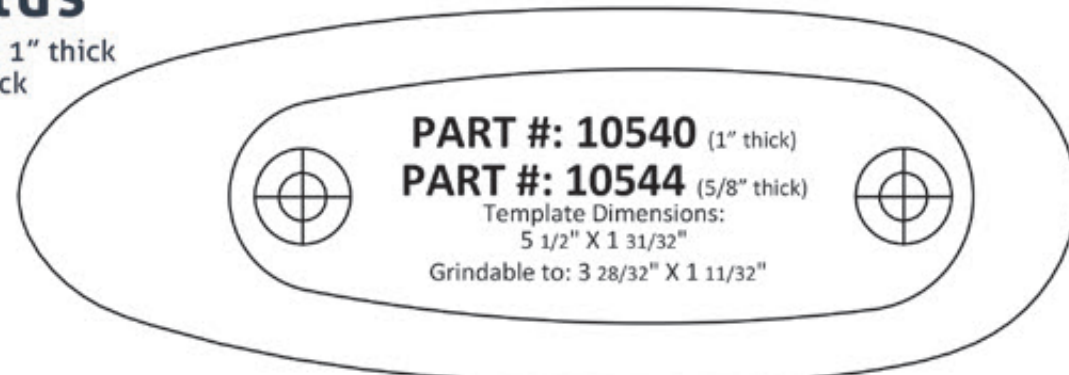

Large

- 10543 - Classic - 1" thick
- 10536 - Trap - 1" thick
- 10539 - Nitro - 1½" thick



2019 ARCHERY PRODUCT CATALOG



LIMBSAVER

INDUSTRY LEADERS

Always pursuing advancement, we are constantly researching, testing, and evaluating technologies, materials, and designs to ensure that we produce the most effective sound and vibration-dampening products possible.

Well-known companies from around the world come to us to have their products tested, evaluated, and improved by our engineers.

OUR ROOTS

We believe that the best products are born from hard work and determination. From the very beginning, here at LimbSaver, we have been committed to engineering the most advanced products utilizing the most state-of-the-art technology.

Throughout the years, we have been trail-blazers in the industry, producing the most effective noise and vibration-dampening technology.

AMERICAN MADE

The vast majority of our products are made right here in Shelton, WA. For two decades we have been making the highest quality and best performing archery and firearms products in the world.

We have always employed teams of industry experts and engineers that design, test, and perfect every single product, ensuring that what is produced is the best in the world.

We are avid sportsmen, competition shooters, and hunters and we make products that we are excited to use.

NAVIGATION

PRODUCTS	PAGE
Limb & Bow Dampeners.....	04-09
Bow Stabilizers.....	10-15
Stabilizer Accessories.....	16-17
String Dampeners.....	18-19
Quivers.....	20-21
Arrow Rests.....	22-23
Slings.....	24-29
Arrow Puller.....	30
Bow Care Products.....	31
Crossbow Suppression.....	32-33
LimbSaver Bows.....	34-39
Special Order Products.....	40-43

LIMBSAVER

LEADING THE INDUSTRY IN
PERFORMANCE • INNOVATION
CUSTOMER SERVICE



BOW DAMPENERS



Customer Reviews



Now my Bear is Quieter Than Ever!

I purchased these [TwistLox Limb Dampeners] a little over a week ago and just put them on my Bear. I LOVE THEM! I was really surprised at the difference it made when my arrow left my bow. That tedious ping sound was no longer there, and now my Bear is quieter than ever. I honestly see these helping eliminate the "arrow ducking" that all white-tails are notorious for. Will definitely be recommending these to all of my friends!



LimbSaver Makes the Best Dampening Products!

LimbSaver makes the best dampening products and these [Broadband Limb Dampeners and Everlast String Leeches] are no different. They do make a difference in generated noise level regardless of which bow you shoot. One of the nice things about these is that you can change the color of the rings to adapt to new strings or for whatever reason you feel need for a change.

Bow dampeners are essential. Find out which are best for you.

Split-limb dampeners

TWISTLOX

Split-Limb Dampener

EASIEST INSTALLATION

Simply twist to lock in position for a secure fit in wide or narrow-spaced limb gaps



BROADBAND

Split-Limb Dampener

SECURES WITH BRACKET

Great for all split-limb bows, including bows with tapered limb gaps



SUPERQUAD

Split-Limb Dampener

UNIVERSAL FIT

Two orientations securely install between wide or narrow-spaced limb gaps



ALPHASHOX

Split-Limb Dampener

DESIGNED FOR HOYT BOWS

Securely installs on Hoyt bows with 3/4-inch gap between limbs



Solid-limb dampeners

BROADBAND

Solid-Limb Dampener

EASY, STICK-ON INSTALLATION

Industrial-strength 3M adhesive keeps product fixed in place



BROADBAND RECURVE

Solid-Limb Dampener

GREAT FOR NARROWER LIMBS

The smaller adhesive base and overall size is perfect for narrow-width recurve or youth size solid-limb compound bows



Vibration Dampening Accessories

MINI ULTRAQUAD

Bow and Gear Dampeners

SMALLEST SIZE DAMPENERS

Stick these tiny, lightweight dampeners anywhere on your bow or gear for added vibration and noise control



INSULATOR STRIPS

Bow Grip Dampeners

INSULATES YOUR HAND

Adds comfort while gripping your bow, especially in cold temperatures



TENTACLE GRIP WRAP

Bow Grip

COMFORT AND GRIP

Isolates your hand from vibration, bow shock, cold and heat



TWISTLOX



TOP VIBRATION DAMPENING

Made from our proprietary NAVCOM® technology (Noise and Vibration Control Material), TwistLox noticeably dampen noise and vibration by up to 75% when shooting your compound bow.

TwistLox limb dampeners for split-limb bows are a result of extensive development and testing.



FOR TOP PERFORMANCE,
ALWAYS CHOOSE LIMBSAVER

- 3.92
- 1.58

REDUCE
UP TO 75%
OF LIMB VIBRATION



BOW WITHOUT LIMB DAMPENERS
LIMBSAVER® TWISTLOX
RESULTS SHOWN AT 50/1000 MARK
(LOWER IS BETTER)

EASY INSTALLATION



Installation is easier than ever! Simply slide in between limbs and twist to lock for a snug and secure fit. They can be installed in two orientations for wide or narrow-spaced limb gaps. Use the narrow orientation for up to a 3/4" limb gap and wide orientation for a 3/4" to 1 1/8" limb gap.

Use two or more TwistLox dampeners per limb. Mix, match, and make it yours! Not designed for tapered split-limbs.

TWISTLOX

SPLIT-LIMB DAMPENER

The most effective and easiest-to-install limb dampeners for split-limb bows



Contact LimbSaver for special order colors!

TWISTLOX (4 PACK)
4720 Black (B.)
4721 Camo (A.)
See page 41 for special order colors!



LN. | WT.
2 IN | .7 OZ (EA.)

COLORS

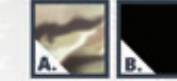

FEATURES

- Easy, no-tool, twist-to-lock installation
- Dampens noise and vibration by up to 75% for a more enjoyable, accurate shooting experience
- Can be installed on most split-limb bows in two orientations
*Not designed for tapered split limbs
- Fits limb gaps from 3/4" up to 1 1/8" wide
- Sold in a 4 pack, use two or more TwistLox per limb

SUPERQUAD

SPLIT-LIMB DAMPENER

A classic popular and effective bracketless split-limb dampener



LN. | WT.
2 IN | 1.1 OZ (EA.)

SUPERQUAD (2 PACK)
3473 Camo (A.)
3474 Black (B.)
See page 40 for special order colors!



COLORS

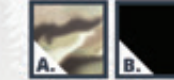

FEATURES

- Reduces noise and vibration by up to 70%
- No tools required for installation
- Can be installed on most split-limb bows in two orientations
*Not designed for tapered split limbs
- Fits limb gaps from 3/4" up to 1 1/8" wide
- Sold in a 2 pack

ALPHASHOX

SPLIT-LIMB DAMPENER FOR HOYT BOWS

AlphaShox will make your Hoyt even better by making it quieter and smoother to shoot



LN. | WT.
2.5 IN | 1.3 OZ (EA.)

ALPHASHOX (2 PACK)
3432 Black



FEATURES

- Dampens noise and kills vibration
- Designed for Hoyt bows with 3/4-inch gap between limbs and may also work on other split-limb bows
- Reduces unwanted noise and vibration by up to 70%
- Sold in a 2 pack



BROADBAND LIMBSAVERS

DEPENDABLE TECHNOLOGY

Engineered to reduce up to 70% of limb vibration over a wide frequency range, the Broadband LimbSaver provides excellent vibration and noise control that's vital for stealth and accuracy.

Broadband Limbsavers give your solid or split-limb bows a noticeably smoother, quieter shot.



BROADBAND LIMBSAVER

SOLID / SPLIT-LIMB DAMPENER

Classic, dependable vibration dampening for solid-limb or split-limb bows

FEATURES

- Helps produce a smoother and quieter shot
- Reduces vibration caused by your limbs by up to 70%
- **SOLID LIMB** version features industrial-strength 3M adhesive that securely adheres to your solid limbs
- **SPLIT LIMB** version uses a bracket to securely install between your limbs and features an improved NAVCOM® washer that keeps the dampener in place - Great for narrow-split or tapered-split limbs!
- Rings can be swapped out for other colors to match your bow
- Sold in 2 packs, or in a Color MultiPack that includes 2 Broadbands with camo, black, red, and green rings.



SOLID LIMB
DIA. | WT.
1.69 IN | .5 OZ (EA.)

SPLIT LIMB
DIA. | WT.
1.8 IN | 1.5 OZ (EA.)

BROADBAND SOLID (2 PACK)
4001 Black Rings
4002 Camo Rings
4015 Color MultiPack*

BROADBAND SPLIT (2 PACK)
4020 Black Rings
4021 Camo Rings
4035 Color MultiPack*

*MultiPack includes two Broadband LimbSavers with camo, black, red, and green rings. 8 rings total! See page 40 for special order colors!

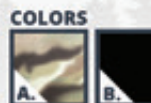

RECURVE BROADBAND LIMBSAVER

SOLID-LIMB DAMPENER

Small size, great vibration dampening properties

LN. | WT.
1.46 IN | 1.1 OZ (EA.)

RECURVE BROADBAND (2 PACK)
4089 Black (B.)
4090 Camo (A.)
See page 40 for special order colors!

COLORS



Great for youth compound bows, too!



FEATURES

- These offer vibration dampening properties at a fraction of the size of our Broadband Limb Dampeners.
- They are ideal for the smaller limb width of some recurve bows as well as youth-sized solid-limb compound bows
- This low-profile limb dampener provides excellent vibration and noise control.

MINI ULTRAQUAD LIMBSAVER

BOW & GEAR DAMPENER

Smallest size, stick-anywhere dampener



LN. | WT.
.88 IN | .6 OZ (EA.)

MINI ULTRAQUAD LIMBSAVER (3 PACK)
3007 Black



FEATURES

- Dampens vibration and unwanted noise on all of your archery gear
- These small, lightweight dampeners are designed for accessories including sights, arrow rests, quivers, cams, and more
- They adhere to your gear using industrial-strength adhesive and can be used in all harsh weather conditions

INSULATOR STRIP

BOW GRIP DAMPENER

Insulate your hand from cold riser and shock



LN. | WT.
3.5 IN | 1.1 OZ (EA.)

INSULATOR STRIP (2 PACK)
3410 Black



FEATURES

- Insulates your hand from the cold riser and adds comfort while gripping your bow
- Attaches on the front of your bow grip and won't increase your grip width. Product is 3/16" thick and will increase grip depth
- Sold in a 2 pack

TENTACLE GRIP WRAP

BOW GRIP

Isolates your hand from vibration and hand shock while non-slip material ensures consistent grip, even while wet



LN. | WT.
24 IN | 1.4 OZ (EA.)

TENTACLE GRIP WRAP
3407 Black



FEATURES

- Isolates your hand from vibration and bow shock
- Non-slip material ensures consistent grip even while wet
- Insulates against cold and heat
- Quickly and securely wraps around your bow grip



STABILIZERS



Customer Reviews

★★★★★

Liked Mine so Well I Bought One for my Son-in-Law

My bow came with a solid hard stabilizer that only helped balance the bow. I had read about these LimbSaver S-Coil Stabilizers and thought I'd give it a try. It made a terrific difference in the hand shock I felt and quieted down my bow significantly. It was the first LimbSaver product I tried and it made such a big difference I added other LimbSaver products to my compound bow and my cross-bow. This fall I bought my son-in-law a used bow and the first thing I did when it arrived was buy him a LimbSaver S-Coil.

★★★★★

Best Decision Yet!

Before this purchase [LS Hunter Micro] I was sceptic about longer stabalizers about why you would need one only because I have never shot with one before. After the decision to upgrade from the S-Coil to this, I was sold and proven wrong. Now I'm able to shoot tighter groups [at] longer distances compared to before [the] the S-Coil.

Find the right bow stabilizer for your shooting style

carbon fiber

LS HUNTER MICRO

8" - 7.6 oz (w/ weights)
9.5" - 8.3 oz (w/ weights)

TOP PERFORMANCE

Rigid carbon fiber structure, FW1 weight system, and vibration technology throughout make this stabilizer the cream of the crop



LS HUNTER MICRO LITE

7" - 2.7 oz

ULTRA-LIGHTWEIGHT

Perfect for hunters who want to keep their bows as lightweight as possible



LS HUNTER LITE

7" - 3.8 oz

GREAT VALUE

Lightweight, and compact. Popular with hunters and youth shooters



new for 2019

SPARTAN

4.25" - 4 oz

BEST VALUE FOR YOUR MONEY

Designed to hit the mark for performance and affordability



S-COIL PRO

4.5" - 4.8 oz

EFFECTIVE VIBRATION CONTROL

Utilizes a series of Broadband Nodes to reduce a wide range of vibration, hand shock and unwanted noise



HD S-COIL

4.5" - 5 oz

MATCHES YOUR FAVORITE CAMO

Design helps keep you hidden while quieting your shots so you will never be noticed



S-COIL

4.5" - 4.5 oz

TRIED AND TRUE CUSTOMER FAVORITE

Impressive vibration and noise reduction from a short, lightweight package



MINI S-COIL

3.5" - 3 oz

SMALL SIZE, BIG PERFORMANCE

Extra-short length is compatible with most bow cases



S-COIL EXTENSION

2.75" - 2.5 oz

ADDS MASS AND LENGTH

Mount any stabilizer to the end of this for added vibration dampening and stabilization



FOR TOP PERFORMANCE, ALWAYS CHOOSE LIMBSAVER!



WITHOUT STABILIZER
WITH LS HUNTER MICRO STABILIZER

SPARTAN

NEW FOR 2019
4.25" COMPACT STABILIZER

Designed to hit the mark for performance and affordability so you get more value for your money



FEATURES

- Great value and performance
- Smoother shooting feel
- Feel less hand shock
- Compact length of 4.25": great for shooting in confined spaces such as ground blinds, treestands, and brushy areas
- Lightweight: approx. 4 oz

SPARTAN
4840 Standard Camo (A.)
4841 Black (B.)



LN. 4.25 IN | WT. 4 OZ

S-COIL PRO

4.5" COMPACT STABILIZER

This enhanced and redesigned version of our popular, classic S-Coil brings you advanced hand shock and vibration reduction



FEATURES

- Utilizes a series of Broadband Nodes to reduce vibration and noise
- Smoother shooting feel
- Feel less hand shock
- Compact length of 4.5": great for shooting in confined spaces such as ground blinds, treestands, and brushy areas
- Lightweight: approx. 4.8 oz

LN. 4.5 IN | WT. 4.8 OZ



S-COIL PRO
4560 Standard Camo Rings
4561 Black Rings

HD S-COIL

4.5" COMPACT STABILIZER

The HD S-Coil Stabilizer helps keep you hidden in any terrain



FEATURES

- High definition camouflage
- Reduces vibration and noise
- Feel less hand shock
- Lightweight: approx. 4.8 oz
- Compact length of 4.5": great for shooting in confined spaces such as ground blinds, treestands, and brushy areas



HD S-COIL
4512 Carbon Black (A.)
4514 Mathews Lost Camo® (B.)
4515 Realtree APG® (C.)
4516 Mossy Oak Break-Up Infinity® (D.)
4517 Moon Shine™ Camo - Muddy Girl® (E.)
4519 Realtree Xtra® Green (F.)
4522 Mossy Oak Break-Up Country® (G.)
4523 Realtree Max-1® (H.)
4524 Lost Camo® XD (I.)

LN. 4.5 IN | WT. 4.8 OZ

MINI S-COIL

3.5" COMPACT STABILIZER

The compact stabilizer fits in most bow cases while installed on bow and offers minimal weight with great vibration-dampening performance



FEATURES

- Ultra-compact length of 3.5": Fits in most bow cases while installed and is great for shooting in confined spaces
- Smoother shooting feel
- The Mini S-coil is popular with youth shooters
- Reduces vibration and noise
- Feel less hand shock
- Lightweight: approx. 3 oz

LN. 3.5 IN | WT. 3 OZ

MINI S-COIL
3063 Standard Camo (A.)
3064 Black (B.)
See page 41 for special order colors!

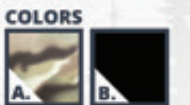

S-COIL

4.5" COMPACT STABILIZER

Popular with hunters and youth shooters, the S-Coil® is our all-time best-selling stabilizer for its impressive vibration and noise reduction and short, lightweight package



FEATURES

- Smoother shooting feel
- Reduces vibration and noise
- Feel less hand shock
- Compact length of 4.5": great for shooting in confined spaces such as ground blinds, treestands, and brushy areas
- Lightweight: approx. 4.5 oz

S-COIL
3061 Standard Camo (A.)
3062 Black (B.)
See page 41 for special order colors!

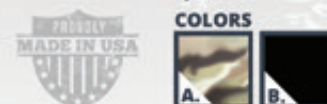

LN. 4.5 IN | WT. 4.5 OZ

S-COIL EXTENSION

2.75" STABILIZER ACCESSORY

Adds mass and length to any stabilizer for an additional level of vibration dampening and stabilization



FEATURES

- Length extension of 2.75": Add length and extra vibration dampening to any stabilizer
- Features a 5/16-inch thread for stabilizers to screw into
- Smoother shooting feel
- Lightweight: approx. 2.5 oz

LN. 2.75 IN | WT. 2.5 OZ

S-COIL EXTENSION
3068 Standard Camo (A.)
3069 Black (B.)
See page 42 for special order colors!



LS HUNTER MICRO

8" AND 9.5"
WEIGHTED STABILIZERS

LS Hunter Micro stabilizers are made out of high-modulus carbon and include weights for top performance



FEATURES

- 5.6 ounces of added weight (including a set of two 2-ounce weights) on the end of the stabilizer gives you a steady shot and helps you keep your pin on the target, increasing accuracy
- Add as many additional weights as you want to the end of the enhancer using the built-in 5/16" thread mount
- FW1 Stabilizer Enhancer effectively dampens unwanted vibration and helps your bow settle faster
- Narrow 5/8" diameter, ultra-rigid, high-modulus carbon fiber does not flex or bounce to give you optimum stabilization
- Built with vibration-dampening technology inside for smooth, quiet shots with less hand shock
- Medium weight: 8" is approx. 7.6 oz
9.5" is approx. 8.3 oz



5/16" THREAD MOUNT ALLOWS YOU TO ADD MORE WEIGHT!

COLORS / HD PATTERNS



LN.	WT.
8 IN	7.6 OZ
9.5 IN	8.3 OZ

LS HUNTER MICRO - 8 INCH

- 4770 Black (A.)
- 4772 Mathews Lost Camo® (B.)
- 4773 Realtree® APG® (C.)
- 4774 Mossy Oak Break-Up Infinity® (D.)
- 4775 Moon Shine™ Camo - Muddy Girl® (E.)
- 4776 Realtree Xtra® Green (F.)
- 4777 Mossy Oak Break-Up Country® (G.)
- 4778 Realtree Max-1® (H.)
- 4779 Mathews Lost® XD (I.)

LS HUNTER MICRO - 9.5 INCH

- 4810 Black (A.)
- 4812 Mathews Lost Camo® (B.)
- 4813 Realtree® APG® (C.)
- 4814 Mossy Oak Break-Up Infinity® (D.)
- 4815 Moon Shine™ Camo - Muddy Girl® (E.)
- 4816 Realtree Xtra® Green (F.)
- 4817 Mossy Oak Break-Up Country® (G.)
- 4818 Realtree Max-1® (H.)
- 4819 Mathews Lost® XD (I.)

LS HUNTER MICRO LITE

7" MID-LENGTH STABILIZER

The LS Hunter Micro Lite is the lightest mid-length stabilizer we make

FEATURES

- Double-Broadband Node on the end dampens unwanted vibration and noise
- Narrow 5/8" diameter, ultra-rigid, high-modulus carbon fiber does not flex or bounce to give you optimum stabilization
- Feel less hand shock
- Ultra-lightweight: approx. 2.7 oz - great for hunters who want to keep their bows as light as possible
- Mid-Length of 7": helps to stabilize, but still compact enough to not get in the way when going through brush or while shooting in confined areas

*NOTE: Not compatible with forward weight systems



LN.	WT.
7 IN	2.7 OZ

LS HUNTER MICRO LITE

- 4830 Black (A.)
- 4832 Mathews Lost Camo® (B.)
- 4833 Realtree® APG® (C.)
- 4834 Mossy Oak Break-Up Infinity® (D.)
- 4835 Moon Shine™ Camo - Muddy Girl® (E.)
- 4836 Realtree Xtra® Green (F.)
- 4837 Mossy Oak Break-Up Country® (G.)
- 4838 Realtree Max-1® (H.)
- 4839 Mathews Lost® XD (I.)

COLORS / HD PATTERNS

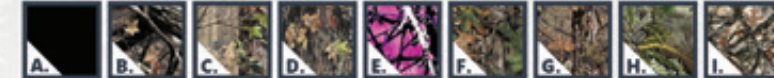

LS HUNTER LITE

7" MID-LENGTH STABILIZER

Affordable quality makes the LS Hunter Lite a popular stabilizer for hunters and youth archers alike



LN.	WT.
7 IN	3.8 OZ

FEATURES

- Small Broadband Enhancer on the end of stabilizer dampens unwanted vibration and noise
- Carbon fiber structure with added vibration control technology gives you a smoother, quieter shot
- Feel less hand shock
- Lightweight: approx. 3.8 oz - keeps your bow light
- Mid-Length of 7": helps to stabilize, but still compact enough to not get in the way when going through brush or while shooting in confined areas

*NOTE: Not compatible with forward weight systems

COLORS / HD PATTERNS

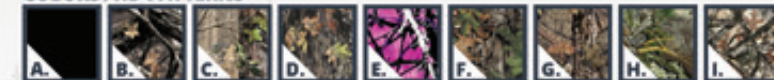

STABILIZER ACCESSORIES

IMPROVE YOUR STABILIZER

LimbSaver Stabilizer accessories are designed to enhance the performance of your bow stabilizers. By using LimbSaver vibration-dampening products, your shots will feel smoother and more comfortable, and will be quieter. By adding forward weight to the end of your stabilizer, you will get improved stability and settling time.



FW1 STABILIZER ENHANCER

WEIGHTED ENHANCER

Adds forward weight to your stabilizer to help keep your bow steady while you center your pin on your target



DIA. 1.65 IN | **WT.** 5.6 OZ

FW1 STABILIZER ENHANCER

- 4820 Black Rings
- 4821 Camo Rings
- 4822 Blue Rings
- 4823 Green Rings
- 4824 Purple Rings
- 4825 Red Rings
- 4826 Pink Rings
- 4827 Orange Rings
- 4828 Yellow Rings

FEATURES

- Add 5.6 ounces of forward weight to your stabilizer to help keep your bow steady while you center your pin on your target
- You can add as many additional weights as you want to the end of the enhancer using the built-in 5/16" thread mount
- Two 2-ounce weights included, additional weights sold separately
- Utilizes a double-Broadband design to greatly reduce vibration and help your bow settle faster for a smoother shot
- Use with any stabilizer that has a 5/16" thread mount on the end

STABILIZER WEIGHTS

4 OUNCES TOTAL

Add weight, add stabilization



STABILIZER WEIGHTS
4570 Set of 2

WT.
2 OZ (EA.)

FEATURES

- Adding weight to the end of your stabilizer helps keep your bow steady and on target while aiming
- Includes two 2-ounce weights with a durable finish

FW1 STABILIZER ENHANCER NODE

WEIGHT COMPATIBLE

Greatly reduce vibration and help your bow settle faster

FW1 STABILIZER ENHANCER NODE

- 4850 Black Rings
- 4851 Camo Rings
- 4852 Blue Rings
- 4853 Green Rings
- 4854 Purple Rings
- 4855 Red Rings
- 4856 Pink Rings
- 4857 Orange Rings
- 4858 Yellow Rings



LN. 1.46 IN | **WT.** 1.1 OZ (EA.)



FEATURES

- Utilizes a double-Broadband design to greatly reduce vibration and help your bow settle faster for a smoother shot
- Use with any stabilizer that has a 5/16" thread mount on the end
- Add as much weight as you want to the end of the enhancer using the built-in 5/16" thread mount
*Weights sold separately

STABILIZER DAMPENER

TWO SIZES AVAILABLE

Upgrades any target stabilizer to a dynamic stabilizer

FEATURES

- Made from LimbSaver's proprietary NAVCOM® material to dampen vibration
- Boosts performance by minimizing whip and vibration to decrease stress on the archer
- Standard size fits most stabilizers with a 1/2 to 7/8-inch tube
- Large size fits most stabilizers with a 3/4 to 1 1/8-inch tube



REGULAR
LN. 1.5 IN | **WT.** .9 OZ

LARGE
LN. 1.9 IN | **WT.** 1.4 OZ



STABILIZER DAMPENER

- REGULAR**
- 4610 Black
- 4611 Camo
- LARGE**
- 4620 Black
- 4621 Camo

See page 43 for special order colors!



BROADBAND STABILIZER ENHANCER

TWO SIZES AVAILABLE

Reduces hand shock and vibration

BROADBAND STABILIZER ENHANCER - REGULAR

- 4690 Black Ring
- 4691 Camo Ring

BROADBAND STABILIZER ENHANCER - LARGE

- 4640 Black Ring
- 4641 Camo Ring

See page 42 for special order colors!



DIA. 1.65 IN | **WT.** .9 OZ

DIA. 2 IN | **WT.** 1.5 OZ



FEATURES

- Gives your stabilizer an extra element of dynamic vibration, hand shock, and noise reduction
- Use with any stabilizer that has a 5/16" thread mount.

STRING DAMPENERS



Customer Reviews



Works Great, Easy to Install, Easy to Tune

[String Decelerator] Needed one that installs on the front stabilizer mount, as my bow is a bit older. Easy to install, easy to adjust. I adjusted it to "just touch" the string and took a couple shots. Then I backed it off about 1/16" and tried it again. For my bow, the 1/16" gap was about perfect. Yours may be different, so it might take a little tweaking to get it right, but it definitely helps reduce the "twang" (even though I have string silencers), and it tightened up my arrow groups. Money well spent!



These Work!!!

I was using "Monkey Tails" but they were breaking off and didn't stay in place. These [Everlast String Leeches] WORK!!!



EVERLAST STRING LEECH®

EXTRA DURABLE

Quiets your strings and is built to last

FEATURES

- Designed to reduce string oscillation and reduce string noise
- Helps to keep your shots quiet and smooth
- Built to last - provides unparalleled performance and unsurpassed durability
- Installs between the strands of bow strings; bow press required for installation



LN. | WT.
1.1 IN | .1 OZ (EA.)

EVERLAST STRING LEECH®
3317 Black 4 Pack
3318 Black 2 Pack

See page 40 for special order colors!



WITHOUT EVERLAST STRING LEECHES
BOW WITH EVERLAST STRING LEECHES

SUPER STRING LEECH®

Most effective string dampener

FEATURES

- Effectively reduces string noise as well as oscillation buzz
- Helps to keep your shots quiet and smooth
- Installs between the strands of bow strings; bow press required for installation



LN. | WT.
1.17 IN | .1 OZ (EA.)

SUPER STRING LEECH®
3313 Black 4 Pack
3315 Black 2 Pack

SUPER CABLE LEECH®

Reduces cable noise

FEATURES

- The Super Cable Leech® reduces cable noise and virtually eliminates cable oscillation
- Installs between the strands of bow cables; bow press required for installation



LN. | WT.
.85 IN | .1 OZ (EA.)

SUPER CABLE LEECH®
3316 Black 4 Pack

STRING DECELERATOR

MOUNTING SYSTEM AND NODE

Stops string oscillation and noise



LN. | WT.
3.17 IN | 3.5 OZ

UNIVERSAL STRING DECELERATOR FRONT/REAR MOUNT

4600 Black
*includes black Decelerator Node, 3/8" rod, mounting bracket and clamp
MSRP: \$44.99

STRING DECELERATOR REPLACEMENT NODE

4601 Black
4602 Camo



FEATURES

- Progressive resistance pillar slows bow string to a stop to minimize slapping noise
- Helps prevent your wrists from getting slapped when you shoot
- Made from LimbSaver's proprietary vibration-dampening NAVCOM® material
- Universal mounting system fits most bows; mounts to front or rear stabilizer accessory holes
- Kit includes string decelerator, cable rod, mounting brackets, and clamp

UNIVERSAL CABLE SLIDE

Silences cable rod chatter

FEATURES

- Produces an ultra-quiet shot and extends buss cable life
- Eliminates cable rod chatter from a wet cable guard
- Made for 3/8-inch cable guards
- 100% PTFE material



LN. | WT.
1.16 IN | .34 OZ

UNIVERSAL CABLE SLIDE
3021 White

CABLE GUARD DAMPENER

Quiets cable guards

FEATURES

- Extremely efficient dampener reduces up to 90 percent of cable guard noise
- Made from LimbSaver's proprietary vibration and noise-dampening NAVCOM® technology



DIA. | WT.
1.8 IN | .55 OZ

CABLE GUARD DAMPENER
3011 Black



SILENT QUIVER

DEADLY SILENCE

The hood and double grippers on the Silent Quiver, made out of NAVCOM®, ensure absolute silence. The flexible properties of the hood and grippers ensure that you do not accidentally make noise when removing your arrow from your quiver.

UNIVERSAL FIT

Its universal design fits most fixed and expandable broadheads, as well as a wide spectrum of shaft sizes. Never lose another arrow! The positionable double grippers securely hold 5 arrows, sizes from .240" - .360".

Gripper inserts are available to adapt the Silent Quiver to fit micro-diameter arrows as thin as .166"!



Customer Reviews

★★★★★
Great Quiver

Easy to install, and arrows stay locked in place. I also like the fact that the quiver does not have foam in the hood that wears out over time.

★★★★★

Quiet, Safe, Stable and Light

The arrows are held securely, and they come out with very little noise. There is never any question of an arrow falling out of the quiver either. I used this quiver on a 9 day hunt in which I covered several miles on foot every day, no arrows ever got close to coming loose, until I wanted one, then it popped out with ease.

After I had had mine for a few months and a couple hunts, I purchased the same quiver for a friend who has a completely different setup than me. He loves the quiver too.

If you are looking for an affordable, reliable, quiet quiver, you've found it.

SILENT QUIVER

NOW AVAILABLE WITH FIBER OPTICS!

Soft, quiet hood and grippers help you stay silent when it really counts by eliminating the risk of noise when removing arrows from your quiver

FIBER OPTIC

NO MORE FUMBLING IN LOW-LIGHT CONDITIONS!
Fiber optic inserts help you see where to place your arrow tips

FEATURES

- Five-arrow quiver with innovative low profile and lightweight design, great for bow hunting
- Quiver hood and arrow grippers are made from soft, flexible, noise and vibration dampening material to prevent noise when removing your arrows
- Positionable grippers securely hold up to five arrows sized 0.240 to 0.360 inches in diameter
- Universal design fits both fixed and expandable broadheads, as well as wide spectrum of shaft sizes
- Available with optional fiber optic hood inserts to assist with arrow placement in low-light conditions
- Quick disconnect system is operated by an easy-to-access thumb release
**compatible with most sights, will not work with HHA sights*
- Durably built to be used outdoors in harsh environments

SILENT QUIVER WITH FIBER OPTIC INSERTS

- 4240 Black (A.)
- 4241 Mathews Lost Camo® (B.)
- 4242 Carbon Black (C.)
- 4243 Realtree® APG® (D.)
- 4244 Mossy Oak Break-Up Infinity® (E.)
- 4245 Moon Shine™ Camo - Muddy Girl® (F.)
- 4246 Realtree Xtra® Green (G.)
- 4247 Mossy Oak Break-Up Country® (H.)
- 4248 Realtree Max-1® (I.)
- 4249 Lost Camo® XD (J.)

SILENT QUIVER

- 3731 Black (A.)
- 3724 Mathews Lost Camo® (B.)
- 3725 Carbon Black (C.)
- 3726 Realtree® APG® (D.)
- 3727 Mossy Oak Break-Up Infinity® (E.)
- 3728 Moon Shine™ Camo - Muddy Girl® (F.)
- 3729 Realtree Xtra® Green (G.)
- 3732 Mossy Oak Break-Up Country® (H.)
- 3733 Realtree Max-1® (I.)
- 3734 Lost Camo® XD (J.)



LN. | WT.
14.75 IN | 12.2 OZ



Also Available:
Gripper Inserts that will keep your micro-diameter arrows secure!

SILENT QUIVER GRIPPER INSERTS
3741 For micro-diameter arrows - Set of 4

COLORS / HD PATTERNS

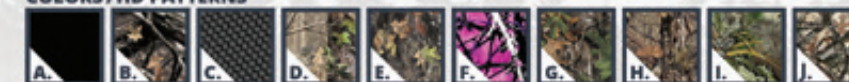



PT100

PRECISION

Flexible Spring Arm (A.) allows for the most accurate lock-up time adjustments without pulling your cables and cams out of time. **Adjustable Lock-Up Time** allows for easy and precise adjustment from 2" to 5"+ of arrow travel before the arm drops, resulting in super-straight arrow flight.

Double-Wedge Locking Clamp System (B.) eliminates marring and denting, which plagues most arrow rests and traditionally makes micro adjustment difficult.

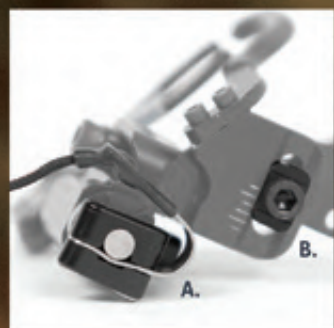

IMPROVED CONTROL

Specially designed Pro Launcher Arm (C.) keeps your arrow in place with or without using the removable top bar, even when your bow is tilted past 90 degrees and eliminates any risk of vane collisions.

The improved and redesigned Lock System (D.) allows you to cock the launcher arm before you draw, which prevents the arrow from falling off the rest during fast or shaky draws or let downs. The improvements make this rest even smoother, quieter, more reliable, and more durable.



PT100

- IMPROVED -
ARROW REST

Customizable for any shooting style to produce straight arrow flight

FEATURES

- Flexible Spring Arm reduces or prevents common timing issues that plague most other rest designs (see pg. 22 figure A.)
- Adjustable Lock-Up Time for super-straight arrow flight
- Double-Wedge Locking Clamp System eliminates marring and denting for easy micro adjustments
- Specially designed Pro Launcher Arm keeps your arrow in place with or without using the removable top bar, even when your bow is tilted past 90 degrees and eliminates any risk of vane collisions
- The newly redesigned Lock System allows you to cock the launcher arm before you draw, which prevents the arrow from falling off the rest during fast or shaky draws or let downs - now more reliable than ever
- Can be installed and fine-tuned in minutes
- Twin-Bearing Launcher System ensures silky smooth operation, even in the harshest environments
- PTFE Arrow Sliders allows a smooth and quiet draw. Moleskin is also included for wrapping
- Includes Arrow Holder and Fall-Away Drop Pad



LN. 3.5 IN | WT. 3.2 OZ

- PT100**
- 4791 RH Black/Silver
 - 4793 LH Black/Silver
 - 4792 RH Black/Gold
 - 4794 LH Black/Gold
 - 4795 RH Black/Black
 - 4797 LH Black/Black
- *Includes PT100 Arrow Rest, Arrow Holder, and Fall-Away Drop Pad



IMPROVED!
LOCKING SYSTEM
now smoother, quieter,
and more reliable



ARROW HOLDER & DROP PAD

- IMPROVED -
ARROW REST ACCESSORIES

Prevents noise from the arm of your fall-away arrow rest



IMPROVED!
FORWARD-COLLAPSING
DESIGN
reduces bounce
back and noise



FEATURES

- **Arrow Holder (A.)**: This self-adhesive pad mounts to any bow riser to keep arrow quietly aligned on shelf
- **Fall-Away Drop Pad (B.)**: This redesigned self-adhesive pad with new forward-collapsing design reduces fall-away arrow rest arm bounce back and impact noise for an even quieter shot and can be used with most rests

FALL-AWAY DROP PAD
3763 Black

ARROW HOLDER
3764 Black

**FALL-AWAY DROP PAD +
ARROW HOLDER COMBO**
3765 Black



LN. 1 IN | WT. .2 OZ



SLINGS



Customer Reviews

★★★★★
Fine piece of equipment

Bought this [The Kodiak-Air Crossbow Sling] for my Wicked Ridge Invader crossbow as it is fairly heavy to transport a long distance. Works great at not sliding off my shoulder. Also the quick release swivels are outstanding to remove it for hunting.

★★★★★
Comfort and Quality!!!!

Great sling! [The Kodiak-Lite Crossbow Sling is] exactly as advertised and works great in the field. No slipping or moving once it's positioned over the shoulder. The rubber is also flexible and conforms well to the shoulder, making it very comfortable.

★★★★★
Nice Sling!

This [Kodiak-Air Crossbow] sling has several advantages. It is made with a material that grips your clothing/shoulder so it will not slip off/down much (if any). The width is good for me. It is also made right here in the USA. Went onto my crossbow within about 30 seconds or so. It is also easily adjusted.

The dependable, comfortable way to carry your bow or crossbow

Compound Bow

KODIAK-AIR

Compound Bow Sling

COMFORTABLE DESIGN
Flexible AirWeb design keeps bow comfortably in place on your shoulder

W/ HD Camo Pattern

Standard



CLASSIC

Compound Bow Sling

COMPACT AND ULTRALIGHT
Easy to pack up and store in your coat pocket when not in use



Crossbow

KODIAK-AIR

Crossbow Sling

COMFORT & CUSTOMIZATION
Non-slip, flexible comfort with adjustable hand grip and Universal Quick Detach System

Standard

W/ HD Camo Pattern

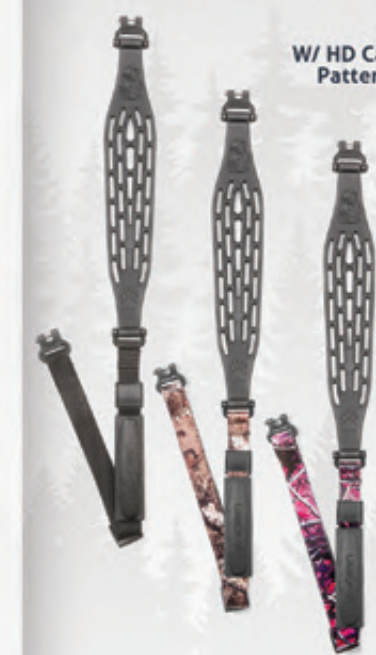

KODIAK-LITE

Crossbow Sling

COMFORT
Flexible, non-slip design keeps you comfortable - with ergonomic hand grip and Standard Detach Bracket



HD Camo Pattern



CROSSBOW SLINGS

FLEX AND COMFORT



NON-SLIP, ALL-WEATHER MATERIAL

SECURE ATTACHMENT

KODIAK-AIR: UNIVERSAL QUICK DETACH



KODIAK-LITE: STANDARD ATTACHMENT

COMFORTABLE HAND GRIP

KODIAK-AIR: ADJUSTABLE HAND GRIP



HANDLE SLIDES AND LOCKS IN PLACE

NOW SOFTER, MORE COMFORTABLE GRIP

UPDATED!

KODIAK-LITE: COMFORTABLE HAND GRIP



KODIAK-AIR

CROSSBOW SLING

Easily the most comfortable and customizable sling on the market with premium, locking hand grip and **Universal Quick Detach**



REPOSITIONABLE HAND GRIP!

KODIAK-AIR CROSSBOW SLING

- 3290 Black (A.)
- 3291 Standard Camo (B.)
- 3292 OD Green (C.)
- 3495 Black w/ Mossy Oak Break-Up Infinity® Strap (D.)
- 3496 Black w/ Moon Shine™ Muddy Girl® Strap (E.)
- 3497 Black w/ Realtree Xtra® Green Strap (F.)



LN. ADJUST. | WT. 6 OZ

COLORS

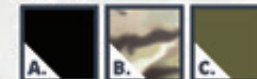

HD PATTERNS

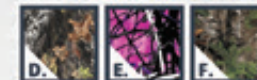

FEATURES

- Advanced sling design enables you to carry your crossbow comfortably for longer periods
- Breathable Air-Web pattern with extra-flexible design molds and bends to your body's contours; distributes weight evenly across your shoulders
- Made from LimbSaver's proprietary NAVCOM® technology; non-slip material keeps your crossbow in place
- High-strength Universal Quick Detach System locks securely and quickly releases with the press of a pin
- Durably built to be used outdoors in harsh environments - from heat to rain to freezing temperatures

KODIAK-LITE

UPDATED FOR 2019 CROSSBOW SLING

Updated, more flexible design keeps you comfortable while carrying your crossbow



IMPROVED! SOFTER GRIP and more flexible sling design

KODIAK-LITE CROSSBOW SLING

- 3207 Black (A.)
- 3208 Standard Camo (B.)
- 3303 OD Green (C.)
- 3246 Black w/ Mossy Oak Break-Up Infinity® Strap (D.)
- 3247 Black w/ Moon Shine™ Muddy Girl® Strap (E.)
- 3270 Black w/ Realtree Xtra® Green Strap (F.)



LN. ADJUST. | WT. 6.9 OZ

COLORS

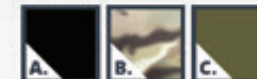

HD PATTERNS



FEATURES

- Comfortable design helps you carry your crossbow for longer periods
- Evenly distributes the weight of your crossbow over a larger area
- Made from LimbSaver's proprietary NAVCOM® technology; non-slip material ensures your crossbow stays put
- Improved softer and more comfortable hand grip provides added control
- Adjustable length
- Durably built for all weather conditions

COMPOUND BOW SLINGS



INTEGRATED HAND GRIP



EASY ON/OFF



KODIAK-AIR

BOW SLING

The comfortable, hassle-free way to carry your bow



- KODIAK-AIR BOW SLING**
 4760 Black (A.)
 4761 Standard Camo (B.)
 4762 OD Green (C.)
 3243 Black w/ Mossy Oak Break-Up Infinity® Strap (D.)
 3244 Black w/ Moon Shine™ Muddy Girl® Strap (E.)
 3275 Black w/ Realtree Xtra® Green Strap (F.)



COLORS

A. B. C.

HD PATTERNS

D. E. F.



LN. WT.
ADJUST. 6.6 OZ

FEATURES

- Comfort-Flex design follows the contours of your shoulder and back to minimize pressure points
- Durably built to be used outdoors in harsh environments - from heat to rain to freezing temperatures; AirWeb pattern keeps you cool
- Made from LimbSaver's proprietary NAVCOM® technology - non-slip material keeps bow in place on your shoulder
- Ergonomic, integrated hand grip gives you next-level control
- Easy on/off with durable quick-connect clips

OTHER USES!
also works great for
PACKING IN
TREE STANDS

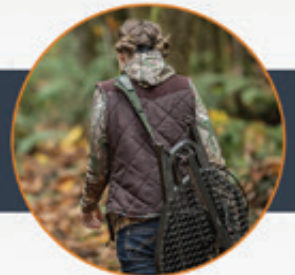

CLASSIC

BOW SLING

Compact and lightweight for easy packing and storage



CLASSIC COMPOUND BOW SLING
3232 OD Green



LN. WT.
ADJUST. 2.3 OZ

FEATURES

- Ultra-lightweight and compact
- Adjustable length
- Easy on/off with durable quick-connect clips
- High-strength, woven-polyester webbing

Grips around arrows to help you effortlessly pull them from your target



FEATURES

- The LimbSaver® Arrow Puller molds around and tightly grips any size arrow shaft
- The grippy material prevents your hand from slipping so you can easily remove the most stubborn arrows, even when wet, dusty, or muddy
- The ergonomic design allows you to comfortably and effortlessly remove arrows from your target
- BRIGHT COLORS make the Arrow Puller easy to find when you need it



LN. | WT.
4.5 IN | 2.7 OZ

ARROW PULLER
3705 Black
3710 OD Green
3712 Blue
3713 Green
3714 Purple
3715 Pink
3716 Red
3717 Orange
3718 Yellow



**PULLS ALL ARROW SHAFT SIZES
WITH EASE AND COMFORT!**

This combo protects your crossbow gear from corrosion and premature wear

FEATURES

- This kit includes two premium products for your crossbow: EcoSafe Crossbow Rail Lube and EcoSafe String Protectant Wax
- Products feature WeatherLock® technology to seal out moisture and prevent wear and tear, corrosion and rust
- Safe to use, these EcoSafe products are non-toxic, non-flammable, and odorless
- EcoSafe Crossbow Rail Lube reduces friction between the rail and string for improved performance
- EcoSafe String Protectant Wax seals out moisture, reduces friction, and keeps your strings in excellent shape to help lengthen the life of your strings

CROSSBOW CONDITIONING KIT

8025 Includes String Wax and Rail Lube



WT.
1.3 OZ

WT.
.5 OZ

**ECOSAFE CROSSBOW
RAIL LUBE**
Crossbow

FEATURES

- Reduces friction between the rail and string for improved performance
- Safe to use, these EcoSafe products are non-toxic, non-flammable, and odorless

ECOSAFE CROSSBOW RAIL LUBE
8001 1.3 OZ



**ECOSAFE STRING
PROTECTANT WAX**
Bow and Crossbow

FEATURES

- Protects and conditions all types of bow and crossbow strings
- Safe to use, these EcoSafe products are non-toxic, non-flammable, and odorless

ECOSAFE STRING PROTECTANT WAX
8003 .5 OZ



ECOSAFE OIL PEN

FOR ALL ARCHERY GEAR

Say goodbye to rust and keep your gear performing smoothly



WT.
.25 OZ

ECOSAFE OIL PEN
8004 .25 OZ



FEATURES

- WeatherLock® technology helps protect your gear from rust and corrosion
- Works on broadheads, field trips, releases, bolts, pins, and all archery gear
- Easy Application; needle applicator allows you to cleanly apply oil, even in tight spots
- Safe to use - it is odorless, non-toxic, non-flammable

CROSSBOW SILENCING



DEADENS NOISE

A major complaint of crossbow hunters is the horrendous amount of noise that results from the shot. Our crossbow suppression accessories reduce vibration energy to ensure every shot will be quieter, smoother, and cause less wear on your crossbow.

We use specialized NAVCOM® (Noise and Vibration Control Material) in varying durometers and configurations to isolate a wide range of vibration frequencies.

By addressing the vibration frequencies that cause audible noise, LimbSaver® crossbow suppressors will reduce the noise of your shot, helping a hunter go undetected and decreasing the chance of game jumping the shot.



Customer Reviews

★★★★★
Worth Every Penny
Tommy, Dick's Sporting Goods Customer

Placed this kit on my Barnett Wildcat c5. The sound dampening was like night and day. If you have a crossbow I highly recommend this kit as it won't disappoint!!!!



CROSSBOW SUPPRESSION KIT

SOLID AND SPLIT-LIMB OPTIONS AVAILABLE

Everything you need stop crossbow noise and vibration dead in its tracks

FEATURES

- TwistLox Suppressors (split-limb) [A] or Crossbow Broadbands (split or solid-limb) dampen limb vibration (See below for more information)
- Stirrup Dampeners [B] attach to almost any foot stirrup with slip-on design and zip tie lock down to reduce noise and vibration
- Bolt Retention Dampener [C] helps to quiet the bolt retaining spring
- Super String Leeches® [D] complete the Crossbow Silencing Kit and reduce string noise (Note: a bow press is required for leech installation)



CROSSBOW SPLIT-LIMB SUPPRESSION KIT
4740 TwistLox Split-Limb - Black
4741 TwistLox Split-Limb - Camo
4187 Broadband Split-Limb - Black Ring
4188 Broadband Split-Limb - Camo Ring

CROSSBOW SOLID-LIMB SUPPRESSION KIT
4178 Broadband Solid-Limb - Black Ring
4179 Broadband Solid-Limb - Camo Ring
MSRP: \$24.99

CROSSBOW STIRRUP DAMPENER
3401 Black (2 pc.)



CROSSBOW TWISTLOX

SPLIT-LIMB

Easy-to-install, effective limb dampeners



CROSSBOW TWISTLOX SPLIT LIMB (4 PACK)
4730 Black
4731 Camo
MSRP: \$19.99

LN. | WT.
1.69 IN | .5 OZ (EA)

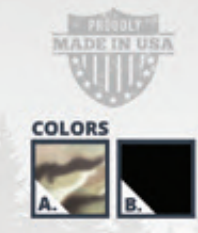

FEATURES

- Reduces up to 50% of vibration as well as noise from the limbs, giving you a noticeably smoother and quieter shot
- Designed for split-limb crossbows and are made durable to withstand the extreme torque and power from high-powered crossbows
- Easy installation - no tools required for installation; Securely lock between your limbs without the use of a plastic bracket *Gaps between limbs must be parallel for proper installation
- Use two or more TwistLox suppressors per limb

CROSSBOW BROADBAND

SOLID AND SPLIT-LIMB OPTIONS AVAILABLE

The best, most effective limb dampener for solid-limb or tapered split-limb crossbows

FEATURES

- Technical design suppresses vibration and noise for a smoother, less disruptive shot
- Larger than the original model for compound bows and are designed to withstand the immense power and energy that crossbows produce
- **Solid-Limb** Crossbow Broadbands securely and easily install; industrial-strength 3M adhesive ensures your limb dampeners will remain in place
- **Split-Limb** Crossbow Broadbands securely install using a bracket system that will not cause damage to your limbs, thanks to the NAVCOM® washers; works great on tapered-limbs



WT.
1.1 OZ (EA)

WT.
1.9 OZ (EA)

CROSSBOW BROADBAND SOLID-LIMB (2 PACK)
4160 Black Rings
4161 Camo Rings

CROSSBOW BROADBAND SPLIT-LIMB (2 PACK)
4169 Black Rings
4170 Camo Rings



LIMBSAVER BOWS

POSI-LOCK

The patented 7-position Posi-Lock Poundage System allows you to effortlessly adjust the poundage with just the turn of a dial. This allows you to drop down or bump up your draw weight without needing to re-tune the bow.

SIGMA CAM

Our Sigma Cams provide the smoothest draw, extra-generous valley, and rock-solid back wall that hunters and sport archers have been looking for in a bow. LimbSaver bows are very forgiving, consistent, and reliable. They are easy to tune and stay in tune unlike other bows. We offer you the confidence to take that once-in-a-lifetime shot.

ROCK-SOLID RISERS

Advanced riser designs are lightweight, super-rigid, and engineered to last a lifetime. They give you a vibration-free, forgiving shot.

LIMBSAVER LE



LE SPECS

Axle-to-Axle: 32 IN
Speed: 327 FPS (IBO)
Brace Height: 7 IN
Mass Weight: 4.1 LBS Bare
Let-Off: 75/80%
Draw Weight: Adjustable 60-70 LBS
Draw Length: 27.5 - 30 IN

- LIMITED EDITION -
Get it before it's gone!

QUIET

A compilation of technologies work together to produce this silent, smooth bow. Every LimbSaver LE comes decked out in LimbSaver dampening gear including Broadband LimbSavers, Cable Guard Dampener, Super String Leeches, and Super Cable Leeches.

AFFORDABLE

The LE offers best price for performance ratio. It was designed to knock out the competition dollar for dollar. There is no better bow in its price range.

POSI-LOCK SYSTEM

The unique Posi-Lock Limb Adjustment System is designed so that brace height and axle-to-axle length remain virtually unchanged allowing you to adjust draw weight without needing to re-tune bow.

SIGMA CAM

The Single-Track Sigma Cam, a highly optimized hybrid cam system, is specifically designed for this bow. It provides high efficiency and impressive arrow speeds.

CONTACT LIMBSAVER® FOR ORDERING INFORMATION

Black and right-hand only.
Sold with Broadband LimbSavers with included yellow, red, green, camo and black rings.



PROTON LS3

Cutting-edge technology makes this bow smooth, quiet, accurate, and forgiving

Nothing shoots like a Proton!

DEADLY SILENT

A compilation of technologies work together to produce the most silent shot in the industry. Every LS3 comes decked out in LimbSaver dampening gear including TwistLox Limb Dampeners, Riser Dampeners, Cable Guard Dampeners, Super String Leeches, and Super Cable Leeches.

ON-POINT ACCURACY

Center-force cable system puts the string track in the center for amazing accuracy

FORGIVING

It is built with a rock-solid limb system. You will notice that the Proton LS3 is very forgiving, consistent, and reliable. It is easy to tune and stays in tune unlike other bows.

POSI-LOCK SYSTEM

The unique Posi-Lock Limb Adjustment System is designed so that brace height and axle-to-axle length remain virtually unchanged allowing you to adjust draw weight without needing to re-tune bow.

SIGMA CAM

Dual-track cam system controls cam lean and cam wobble.



LS3 SPECS

Axle-to-Axle: 32 IN
Speed: 332 FPS (IBO)
Brace Height: 7 IN
Mass Weight: 4.2 LBS Bare
Let-Off: 75/80%
Draw Weights: 40/50/60/70 LBS
Draw Length: 24 - 32 IN

SPECIAL ORDER

Items marked with an "SO" suffix are available items but may require additional processing time. Please allow for the possibility of an additional 2 weeks for processing and shipping

STRING LEECHES

PART NUMBER	DESCRIPTION
3331 SO	Everlast String Leech - Blue - 4 Pack
3333 SO	Everlast String Leech - Green - 4 Pack
3335 SO	Everlast String Leech - Purple - 4 Pack
3337 SO	Everlast String Leech - Pink - 4 Pack
3319 SO	Everlast String Leech - Red - 4 Pack
3351 SO	Everlast String Leech - Orange - 4 Pack
3352 SO	Everlast String Leech - Yellow - 4 Pack
3332 SO	Everlast String Leech - Blue - 2 Pack
3334 SO	Everlast String Leech - Green - 2 Pack
3336 SO	Everlast String Leech - Purple - 2 Pack
3338 SO	Everlast String Leech - Pink - 2 Pack
3320 SO	Everlast String Leech - Red - 2 Pack
3353 SO	Everlast String Leech - Orange - 2 Pack
3354 SO	Everlast String Leech - Yellow - 2 Pack



LIMB DAMPENERS

PART NUMBER	DESCRIPTION
3475 SO	Split Limb SuperQuads - Blue
3476 SO	Split Limb SuperQuads - Green
3477 SO	Split Limb SuperQuads - Purple
3478 SO	Split Limb SuperQuads - Pink
3479 SO	Split Limb SuperQuads - Red
3480 SO	Split Limb SuperQuads - Orange
3481 SO	Split Limb SuperQuads - Yellow
4003 SO	Broadband Solid Bow - Blue Bands
4004 SO	Broadband Solid Bow - Green Bands
4005 SO	Broadband Solid Bow - Purple Bands
4006 SO	Broadband Solid Bow - Pink Bands
4007 SO	Broadband Solid Bow - Red Bands
4008 SO	Broadband Solid Bow - Orange Bands
4009 SO	Broadband Solid Bow - Yellow Bands
4011 SO	Broadband Solid Bow - White Bands
4022 SO	Broadband Split Bow - Blue Bands
4023 SO	Broadband Split Bow - Green Bands
4024 SO	Broadband Split Bow - Purple Bands
4025 SO	Broadband Split Bow - Pink Bands
4026 SO	Broadband Split Bow - Red Bands
4027 SO	Broadband Split Bow - Orange Bands
4028 SO	Broadband Split Bow - Yellow Bands
4031 SO	Broadband Split Bow - White Bands
4091 SO	BroadBand Recurve - Blue
4092 SO	BroadBand Recurve - Green
4093 SO	BroadBand Recurve - Purple
4094 SO	BroadBand Recurve - Pink
4095 SO	BroadBand Recurve - Red
4096 SO	BroadBand Recurve - Orange
4097 SO	BroadBand Recurve - Yellow

LIMB DAMPENERS

PART NUMBER	DESCRIPTION
4722 SO	TwistLox Split Limb Dampener Bow - Blue
4723 SO	TwistLox Split Limb Dampener Bow - Green
4724 SO	TwistLox Split Limb Dampener Bow - Purple
4725 SO	TwistLox Split Limb Dampener Bow - Pink
4726 SO	TwistLox Split Limb Dampener Bow - Red
4727 SO	TwistLox Split Limb Dampener Bow - Orange
4728 SO	TwistLox Split Limb Dampener Bow - Yellow



3373 SO	UltraMax LimbSaver Solid- Black
---------	---------------------------------

STABILIZERS

PART NUMBER	DESCRIPTION
4710 SO	LS Hunter Pro - Black 7.5"
4712 SO	LS Hunter Pro - Lost7.5"
4713 SO	LS Hunter Pro - RealtreeAPG7.5"
4714 SO	LS Hunter Pro - Mossy Oak Breakup Infinity 7.5"
4718 SO	LS Hunter Pro - Mossy Oak Breakup Country 7.5"
4719 SO	LS Hunter Pro - Realtree MAX-1 7.5"
4715 SO	LS Hunter Pro - Muddy Girl 7.5"
4716 SO	LS Hunter Pro - Realtree Xtra Green7.5"
4739 SO	LS Hunter Pro - Lost XD7.5"
4530 SO	LS Hunter - Black 9.5"
4532 SO	LS Hunter - Lost9.5"
4533 SO	LS Hunter - RealtreeAPG9.5"
4534 SO	LS Hunter - Mossy Oak Breakup Infinity 9.5"
4538 SO	LS Hunter - Mossy Oak Breakup Country 9.5"
4539 SO	LS Hunter - Realtree MAX-1 9.5"
4535 SO	LS Hunter - Muddy Girl9.5"
4536 SO	LS Hunter - Realtree Xtra Green9.5"
4540 SO	LS Hunter - Lost XD9.5"
4680 SO	LS Hunter Pro - Black 10"
4682 SO	LS Hunter Pro - Lost10"
4683 SO	LS Hunter Pro - RealtreeAPG10"
4684 SO	LS Hunter Pro - Mossy Oak Breakup Infinity 10"
4688 SO	LS Hunter Pro - Mossy Oak Breakup Country 10"
4689 SO	LS Hunter Pro - Realtree MAX-1 10"
4685 SO	LS Hunter Pro - Muddy Girl10"
4686 SO	LS Hunter Pro - Realtree Xtra Green10"
4709 SO	LS Hunter Pro - Lost XD10"
4150 SO	S-Coil Stabilizer - Red 4.5"
4151 SO	S-Coil Stabilizer - Green 4.5"
4152 SO	S-Coil Stabilizer - Purple 4.5"
4153 SO	S-Coil Stabilizer - Pink 4.5"
4154 SO	S-Coil Stabilizer - Blue 4.5"
4155 SO	S-Coil Stabilizer - Orange 4.5"
4156 SO	S-Coil Stabilizer - Yellow 4.5"
4662 SO	S-Coil Stabilizer - Blue 3.5"
4663 SO	S-Coil Stabilizer - Green 3.5"
4664 SO	S-Coil Stabilizer - Purple3.5"
4665 SO	S-Coil Stabilizer - Pink 3.5"
4666 SO	S-Coil Stabilizer - Red 3.5"
4667 SO	S-Coil Stabilizer - Orange3.5"
4668 SO	S-Coil Stabilizer - Yellow 3.5"



SPECIAL ORDER

STABILIZERS
(CONT.)

PART NUMBER DESCRIPTION

4672 SO	S-Coil Stabilizer Extension - Blue 2.75"
4673 SO	S-Coil Stabilizer Extension - Green 2.75"
4674 SO	S-Coil Stabilizer Extension - Purple 2.75"
4675 SO	S-Coil Stabilizer Extension - Pink 2.75"
4676 SO	S-Coil Stabilizer Extension - Red 2.75"
4677 SO	S-Coil Stabilizer Extension - Orange 2.75"
4678 SO	S-Coil Stabilizer Extension - Yellow 2.75"



PART NUMBER DESCRIPTION

3013 SO	Stabilizer Enhancer - Black
4140 SO	Stabilizer Enhancer - Red
4141 SO	Stabilizer Enhancer - Blue
4142 SO	Stabilizer Enhancer - Green
4143 SO	Stabilizer Enhancer - Purple
4144 SO	Stabilizer Enhancer - Pink
4145 SO	Stabilizer Enhancer - Yellow
4146 SO	Stabilizer Enhancer - Orange



4630 SO	Broadband Accessory Bow - Black (2 pk)
4631 SO	Broadband Accessory Bow - Camo (2 pk)
4632 SO	Broadband Accessory Bow - Blue (2 pk)
4633 SO	Broadband Accessory Bow - Green (2 pk)
4634 SO	Broadband Accessory Bow - Purple (2 pk)
4635 SO	Broadband Accessory Bow - Pink (2 pk)
4636 SO	Broadband Accessory Bow - Red (2 pk)
4637 SO	Broadband Accessory Bow - Orange (2 pk)
4638 SO	Broadband Accessory Bow - Yellow (2 pk)
4639 SO	Broadband Accessory Bow - White (2 pk)



STABILIZER ACCESSORIES

4750 SO	Broadband Accessory Crossbow - Black (2 pk)
4751 SO	Broadband Accessory Crossbow - Camo (2 pk)
4752 SO	Broadband Accessory Crossbow - Blue (2 pk)
4753 SO	Broadband Accessory Crossbow - Green (2 pk)
4754 SO	Broadband Accessory Crossbow - Purple (2 pk)
4755 SO	Broadband Accessory Crossbow - Pink (2 pk)
4756 SO	Broadband Accessory Crossbow - Red (2 pk)
4757 SO	Broadband Accessory Crossbow - Orange (2 pk)
4758 SO	Broadband Accessory Crossbow - Yellow (2 pk)
4759 SO	Broadband Accessory Crossbow - White (2 pk)



4642 SO	Broadband Stabilizer Enhancer (Large) - Blue
4643 SO	Broadband Stabilizer Enhancer (Large) - Green
4644 SO	Broadband Stabilizer Enhancer (Large) - Purple
4645 SO	Broadband Stabilizer Enhancer (Large) - Pink
4646 SO	Broadband Stabilizer Enhancer (Large) - Red
4647 SO	Broadband Stabilizer Enhancer (Large) - Orange
4648 SO	Broadband Stabilizer Enhancer (Large) - Yellow



4692 SO	Broadband Stabilizer Enhancer (Small) - Blue
4693 SO	Broadband Stabilizer Enhancer (Small) - Green
4694 SO	Broadband Stabilizer Enhancer (Small) - Purple
4695 SO	Broadband Stabilizer Enhancer (Small) - Pink
4696 SO	Broadband Stabilizer Enhancer (Small) - Red
4697 SO	Broadband Stabilizer Enhancer (Small) - Orange
4698 SO	Broadband Stabilizer Enhancer (Small) - Yellow



STABILIZER ACCESSORIES
(CONT.)

PART NUMBER DESCRIPTION

4612 SO	Stabilizer Dampener Standard - Blue
4613 SO	Stabilizer Dampener Standard - Green
4614 SO	Stabilizer Dampener Standard - Purple
4615 SO	Stabilizer Dampener Standard - Pink
4616 SO	Stabilizer Dampener Standard - Red
4617 SO	Stabilizer Dampener Standard - Orange
4618 SO	Stabilizer Dampener Standard - Yellow



4622 SO	Stabilizer Dampener Large - Blue
4623 SO	Stabilizer Dampener Large - Green
4624 SO	Stabilizer Dampener Large - Purple
4625 SO	Stabilizer Dampener Large - Pink
4626 SO	Stabilizer Dampener Large - Red
4627 SO	Stabilizer Dampener Large - Orange
4628 SO	Stabilizer Dampener Large - Yellow



PART NUMBER DESCRIPTION

4325 SO	Broadhead Pod - Fixed/Expandable Blade 3 PK- Clear
4301 SO	Fletch Pod- Universal 6 Pack- Clear



ARROW PROTECTION

PART NUMBER DESCRIPTION

3282 SO	Kodiak-Air Treestand Sling - Black
3283 SO	Kodiak-Air Treestand Sling - Camo
3289 SO	Kodiak-Air Treestand Sling - OD Green



TREESTAND SLINGS

HD PATTERNS AND COLORS

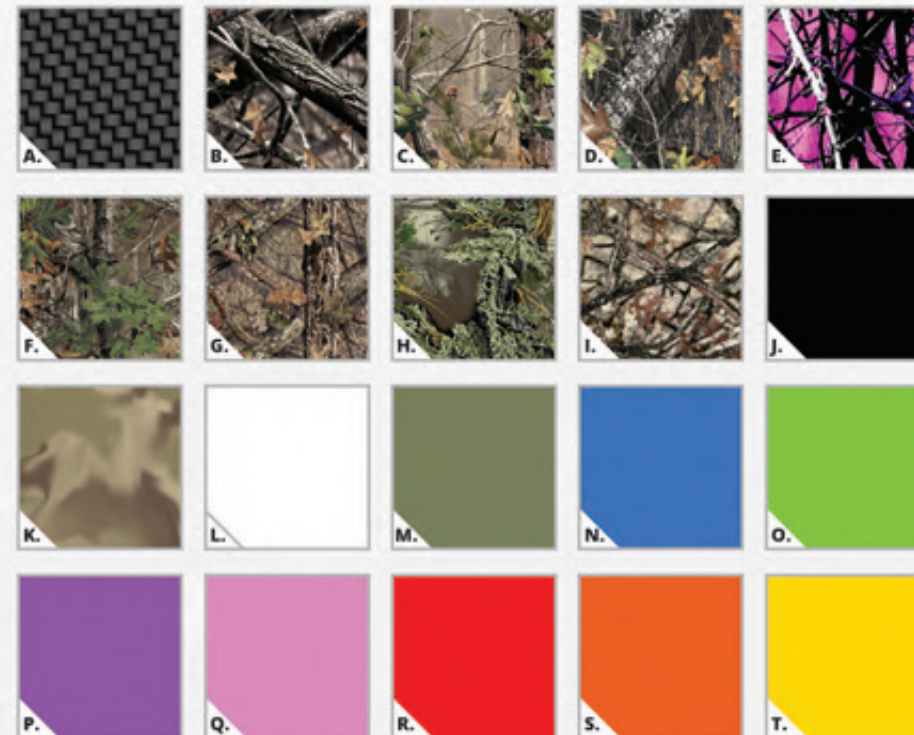

- Carbon Black (A.)
- Mathews Lost Camo® (B.)
- Realtree APG® (C.)
- Mossy Oak Break-Up Infinity® (D.)
- Moon Shine™ Camo - Muddy Girl® (E.)
- Realtree Xtra® Green (F.)
- Mossy Oak Break-Up Country® (G.)
- Realtree Max-1® (H.)
- Lost Camo® XD (I.)
- Black (J.)
- Standard Camo (K.)
- White (L.)
- OD Green (M.)
- Blue (N.)
- Green (O.)
- Green (O.)
- Purple (P.)
- Pink (Q.)
- Red (R.)
- Orange (S.)
- Yellow (T.)