



INSTALLATION INSTRUCTIONS





INSTALLATION INSTRUCTIONS

**Before you begin installation ,
please read the following carefully:**

- **Ensure that the certificate matches the vehicle specifications (front vehicle identification number (VIN)) etc...**
- **The suspension components must match the suspensions application specifications (springs and shock/struts identification numbers).**
- **The instructions have to be strictly observed.**

KW Coilovers for automobile suspensions are designed for easy installation. If not otherwise stipulated in these instructions, all suspension components are installed and removed in accordance with the manufacturer's specifications for installing and removing standard springs and damper components. At the time of printing all instructions and specifications are correct.

| Technical data | Coilover part number 3A7 11 007 | | | |
|--|----------------------------------|-------------------|--|-------------------|
| Vehicle model | Lamborghini Aventador Typ 834 | | max. permissible front axle load: 1000 kg | |
| | front axle | | rear axle | |
| Spring signature | 10-60-80 / 70-200* | | 10-60-80 / 90-250* | |
| Coilover strut / Shock absorber signature | 112 1002 | | 112 1102 | |
| Approximate distance measurement A Front axle: Fastening screw - spring contact area Rear axle: Seating height adjustment - spring contact area or fastening screw - spring contact area | min: | max: | min: | max: |
| | 170 mm / 6,7 inch | 190 mm / 7,5 inch | 150 mm / 5,9 inch | 170 mm / 6,7 inch |
| Approximate measurement* B in mm / inch: wheel hub center to fender edge | min: | | min: | |
| | 340 mm / 13,4 inch | | 360 mm / 14,2 inch | |

Calculating the adjustment range (distance measurement A) : (Photos are examples only)

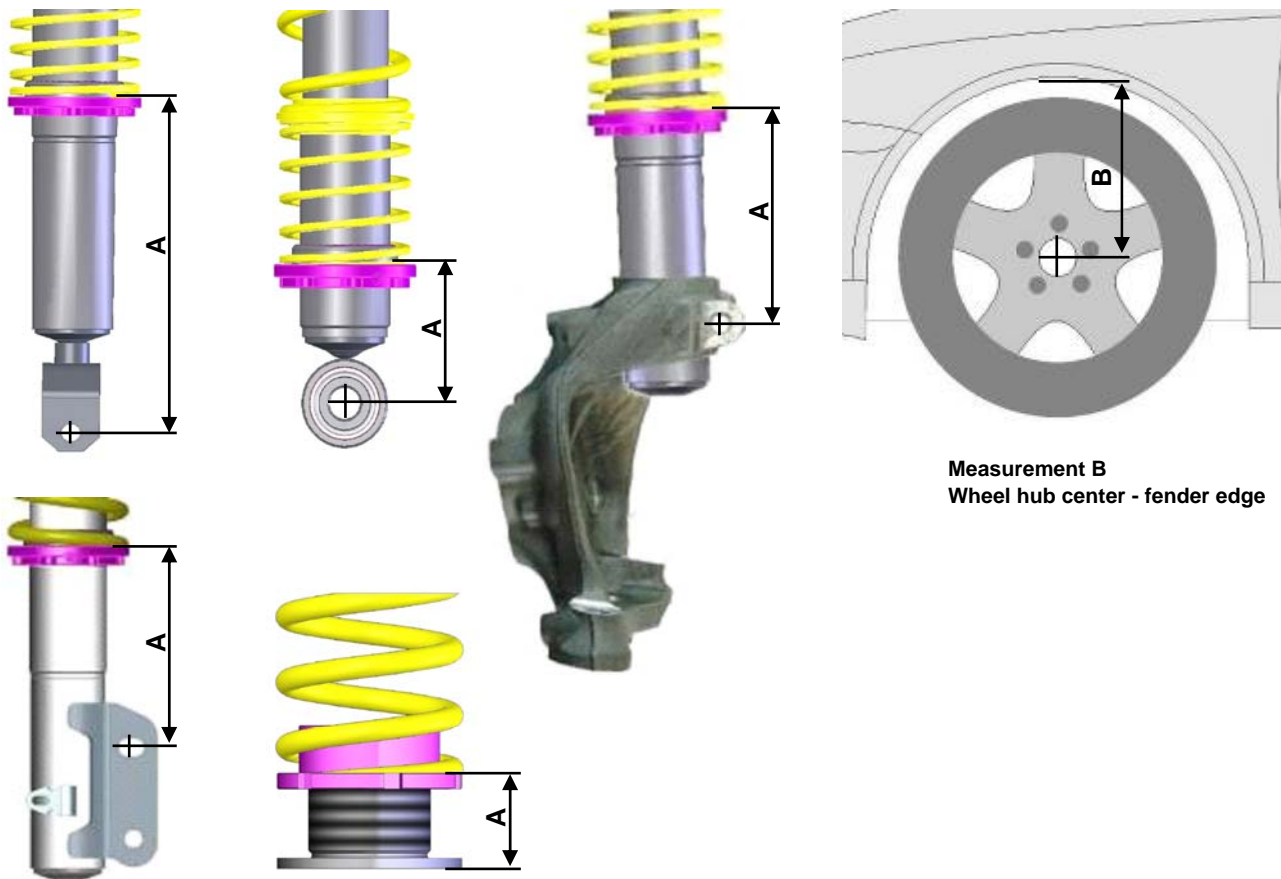

Measurement B
Wheel hub center - fender edge

Please enter the adjusted height of the modified car into the list:

| Coilover part no | Vehicle type | Measurement A | | Wheel hub center - fender edge Measurement B | |
|------------------|--------------|---------------|------|---|------|
| | | Front | Rear | Front | Rear |
| | | | | | |

* **IMPORTANT:** The allowable measurement between wheel hub center and fender edge as indicated above, may not exceed these measurements when using standard fenders.

Danger:

Always follow the latest accident prevention regulations (not applicable for North America) for each step to prevent any serious bodily harm or injury.

1. We recommend the use of a vehicle hoist or lift when installing the suspension. If a lift is not available and jacking equipment is used, make sure that the vehicle is secured with commercial wheel blocks and jack stand to ensure safety.
2. The suspension components may only be installed by trained technical personnel using the proper tools.
3. The General Installation instructions, as well as the Technical Inspectorate documents must be read BEFORE attempting installation.
4. Never use impact wrenches or guns to install or remove shock absorber piston hardware.
5. Never disassemble or cut open shock absorbers and/or shock absorber inserts. They contain oil under pressure. Danger of explosion.
6. Before driving on public highways, carry out the work steps on page 7, items 11 through 14 after installation.
7. The suspension regulation (when available) needs to be disabled through an authorized dealer.
8. Please take care in any case that fittings (for example fittings of shock absorber housings or fittings of the lower control arm in the housing of the wheel bearing) are free of dust and oil. (see manufacturer guideline)

General Instructions for Use:

1. When adjusting the vehicle height, make sure that the threads are clean and free of debris. After initial cleaning, move the perch by 10 mm (0.4 Inches) downwards, and then clean the area that you desire to adjust the perch (up or down).
2. During height adjustments on separate shock and spring systems, remove the perch from the vehicle to adjust the height.
3. After adjusting the vehicle height, repeat steps 11 through 14 from page 7.
4. In the area of the piston rod and the sealing package of the new and used damper there might be oil and grease collected. This could either be caused by using a special black grease during assembling the washer or due to accumulation of streak oil. Further more oil is used during assembling the cartridge and rod guide. There is no reason of worrying about and damage, as in this area also dust and dirt used to be collected.

Tightening torque for the piston rod nut:

M8 = **25Nm (18 ft-lb)**, M10x1 = **20Nm (15 ft-lb)**, M10x1,25 = **20Nm (15 ft-lb)**, M12x1,25 = **35Nm (26 ft-lb)**,
M12x1,5 = **40Nm (29 ft-lb)**, M14x1,5 = **50Nm (37 ft-lb)**, M16x1,5 = **50Nm (37 ft-lb)**

Copyright

This assembly guideline is protected by copyright law. This assembly guideline is subject to a right to download and print the guideline which we grant for the purpose of the installation of products that have been purchased from us. Further reproduction is not allowed. Any devolution or sub-licensing of this copyright to a third party as well as any manipulation of the photographs is not allowed. We are entitled to cancel the granted copyright at any time. Copyright violations will be prosecuted.

General Mounting Specifications:

1. We recommend the use of a vehicle hoist or lift when installing the suspension.
 2. **Caution:** If the vehicle is equipped with ride height sensors, they should be removed before removal of struts or dampers, otherwise damage may occur.
 3. The struts should be removed as specified by manufacturer's instructions.
 4. Manufacturer recommended tools for removal of the original struts, or a suitable spring compressor, must be used in order to remove most factory mounted suspension systems.
 5. Mount the complete suspension system as described on the following pages.
 6. Never use impact drivers to install nuts on the piston rods as permanent damage may occur. It is imperative that you do not damage the piston rod surface, through use of pliers etc, as the smallest damage will result in seal damage, and will not be covered under warranty.
 7. Stay within the lowering range specified in the table on page 3.
Example: With a specified range of 20 - 60 mm (0.8 - 2.3 Inches), 40 mm (1.5 Inches) is your height adjustment range.
 8. Ensure that the set screw on each spring collar is tightened to prevent movement of the spring perch. On vehicles with separate shock/spring combinations, no set screw is necessary.
Caution: Do not over tighten the set screw. Maximum torque is 1 - 2 Nm (0.74-1.47 ft-lb).
 9. Install the suspension components in the vehicle as specified by the vehicle manufacturers in their document.
 10. Except as noted, all torque values must comply with manufacturer recommended specifications.
 11. After assembly and installation is complete, the vehicle should be rolled onto level ground. Once on level ground, measure the vehicle height and adjust to the customer's requirements, within the prescribed lowering range.
Caution: Wheel hub center—wheel arch maximum measurement in the table of page 3 must not be exceeded! Also take into account minimum road clearances specified in the table on page 7 (only valid for Germany!).
Caution: It is common for the vehicle suspensions to settle by an additional 5 - 10 mm (0.2 - 0.4 Inches)
 12. Examine the clearance between the tires and the suspension over the full range of motion of the wheel. The minimum clearance between the suspension and the tire is 4 mm (0.16 Inches). If this clearance is less than 5 mm (0.2 Inches), wheel spacers may be necessary. With strut designs that are located close to the wheel, but that have no steering functions, use 100 mm (3.9 Inches) spacers on diagonally opposed wheel (e.g. front right, rear left). In this position, you must be able to achieve the minimum clearance required. You can also check the clearance between tire and body.
Caution: With torsion beam trailing arm axles, this method is not sufficient. The wheel must be under full load as well as test driven to properly calculate the clearances of 5 mm (0.2 Inches) from any other components.
 13. The geometry of the suspension needs to be adjusted according the regulations of the vehicle manufacturer. If a value cannot be reached due to the difference in the height, a optimal value next to the tolerance range of the vehicle manufacturer needs to be adjusted.
 14. All components that are controlled by vehicle ride height (e.g. headlights, brake bias regulator etc.) must be adjusted as specified by the vehicle manufacturer instructions and procedures.
 15. For vehicles with ESP, DSC or EPC your new suspension components may cause an engine fault code to appear. This is only temporary as the vehicle electronics adjust to the new components/height. On some models this will end after driving approximately 3-5 miles, or through turning the steering wheel from full left to full right. On other models, this must be reset through the factory diagnostic port by a qualified technician.
-

Front axle:

Standard coilover strut.

Remove the secure clip and dismantle the spring perch.



Remove the spring.
Mount the supplied special tool on the piston rod and dismantle the top damper eye.

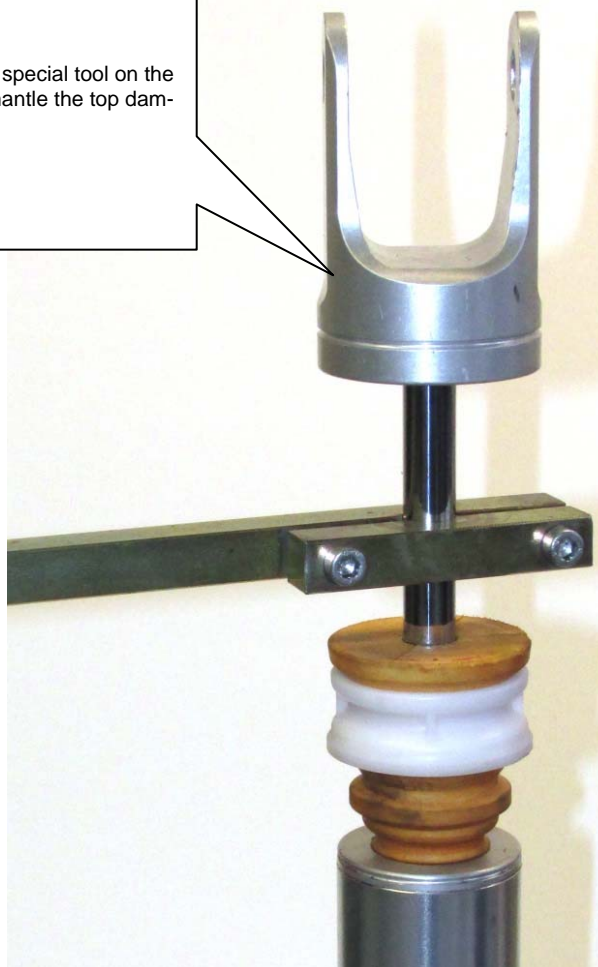

Front axle:

Remove the bump Stopp and thoroughly clean the shock absorber!

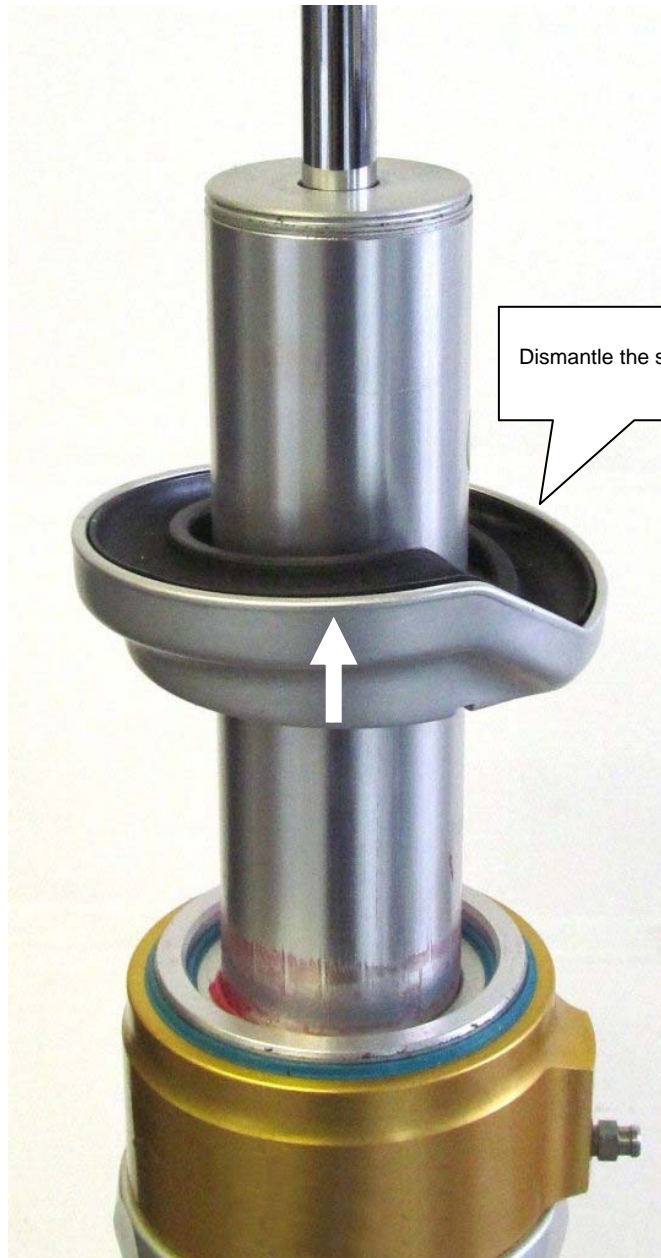

Dismantle the spring perch.

Front axle:

Supplied coilover strut.

The upper eye must be removed for the dismantling of the springs.
For this loosen the marked screws.

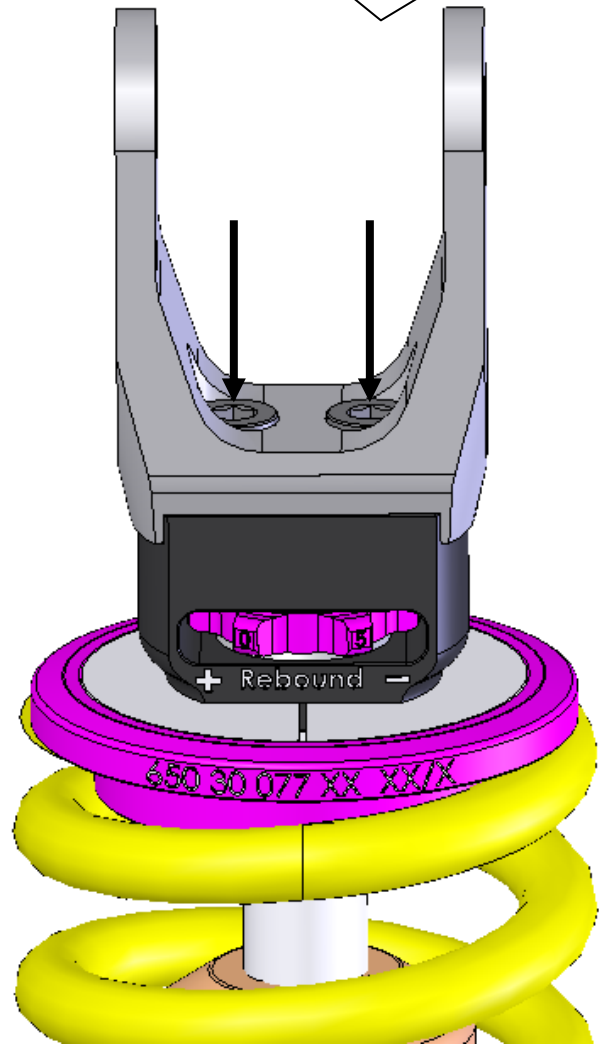
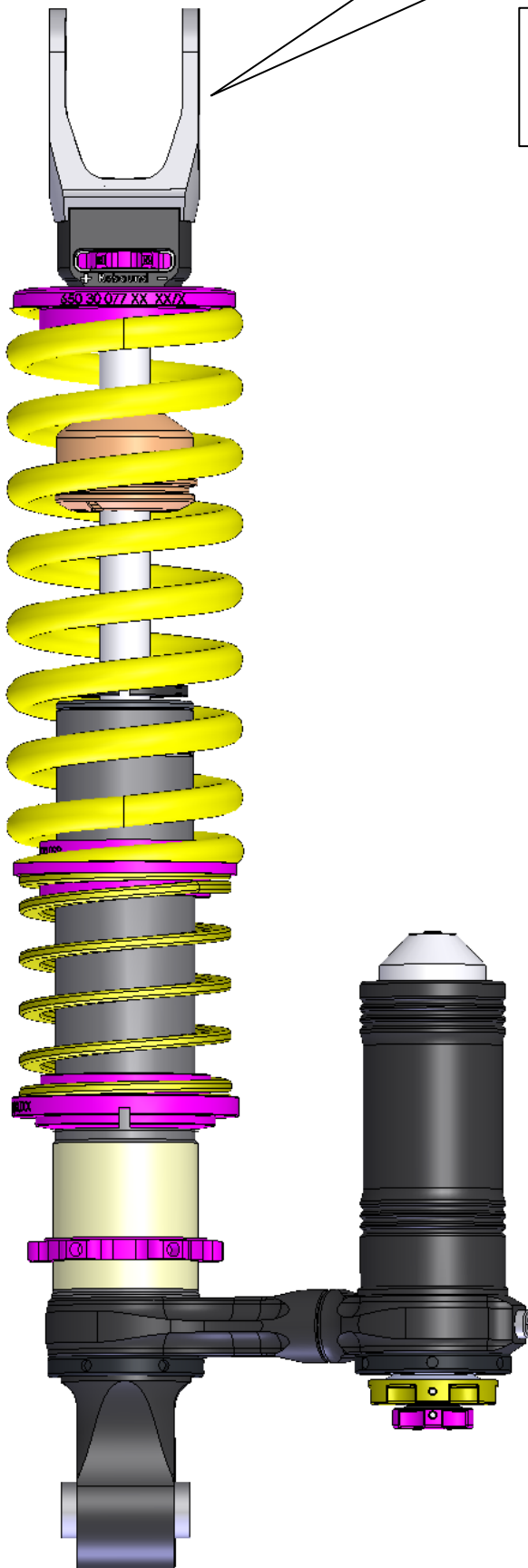

Front axle:

Dismantle the following parts.

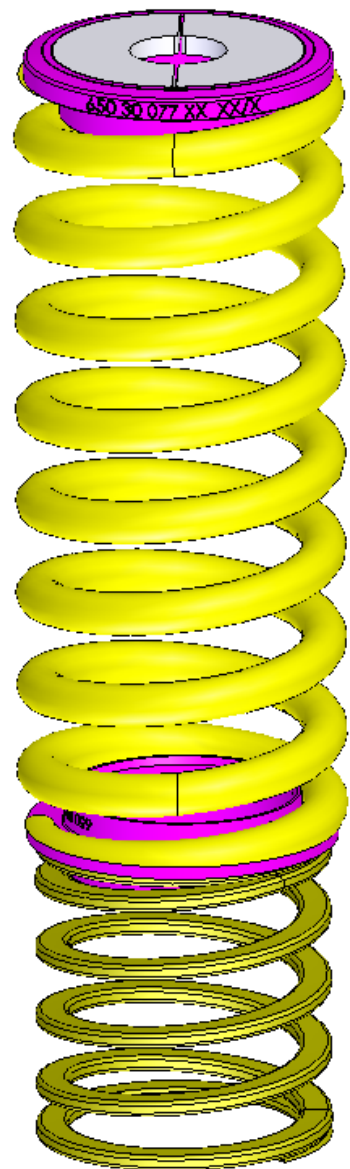
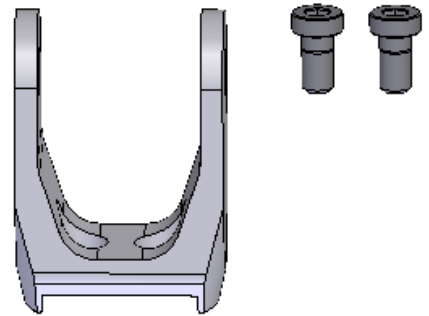
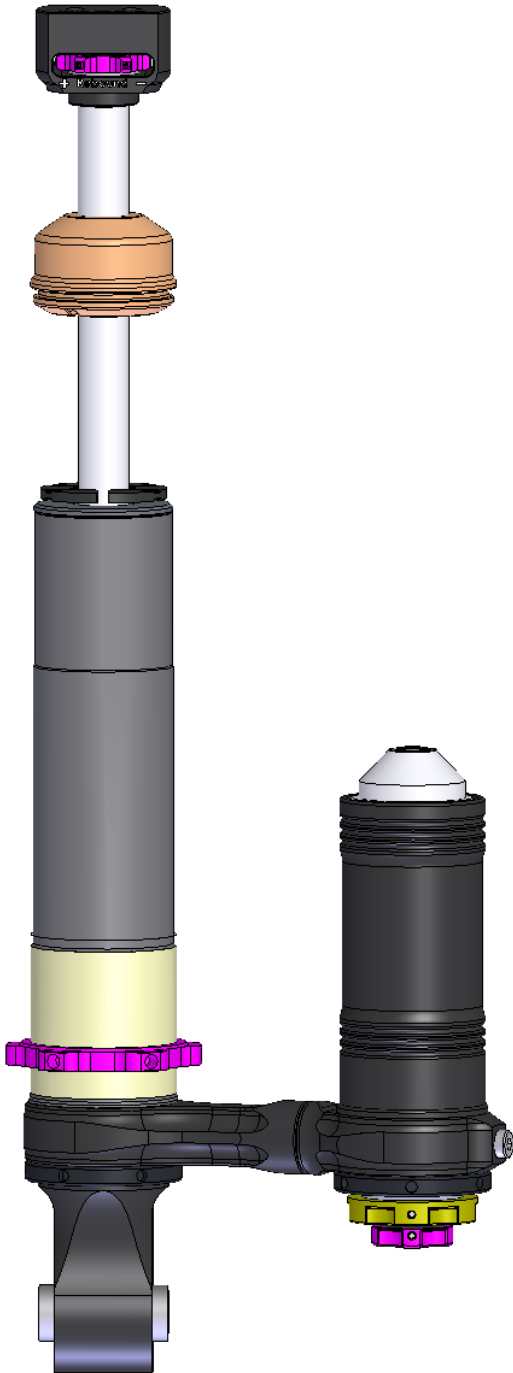

Bottom spring perch.

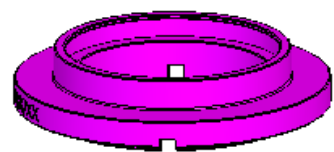

Front axle:

Dismantle the wiper ring out of the standard spring perch and install it into the supplied spring perch.

EOM spring perch.

Wiper ring

Supplied spring perch.

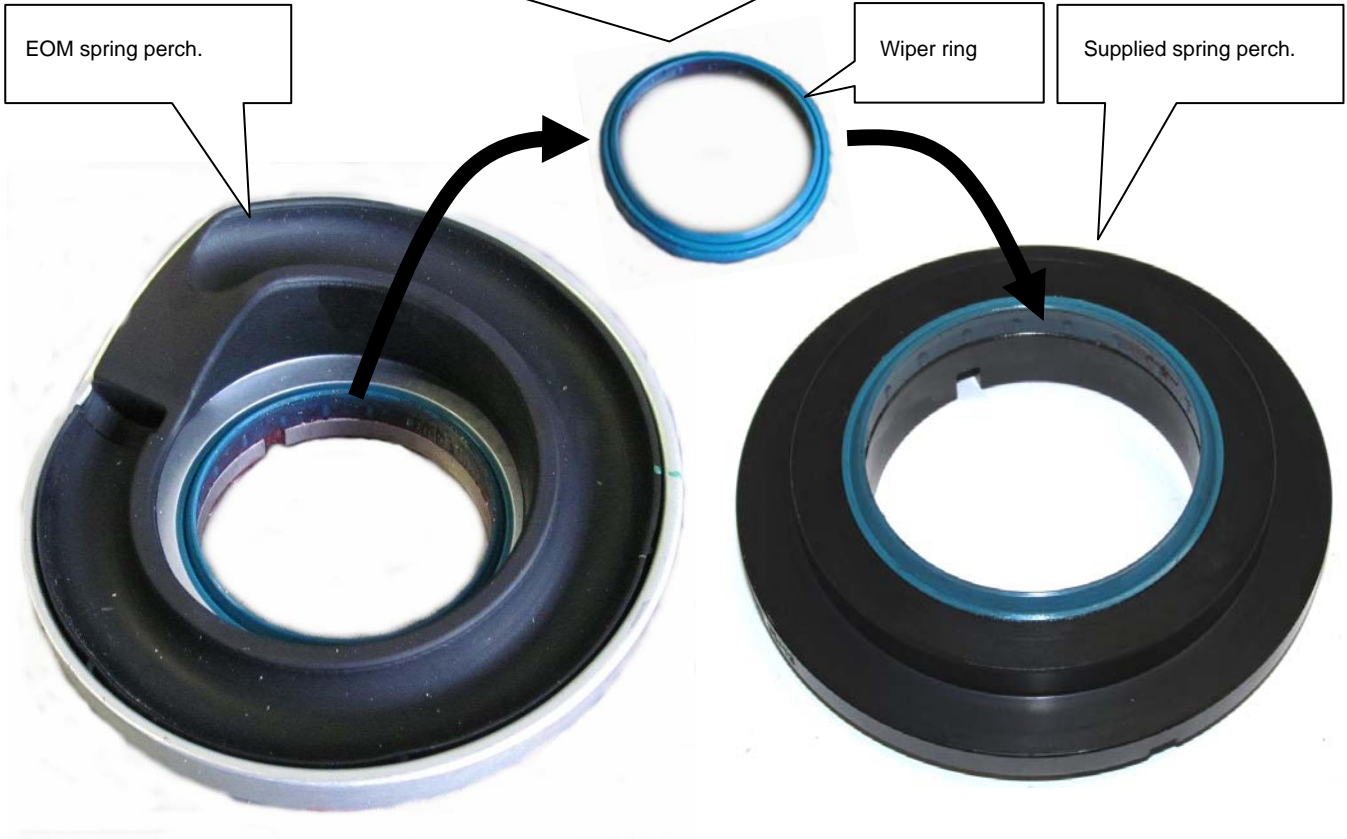

Put the original hydraulic cylinder on the strut.

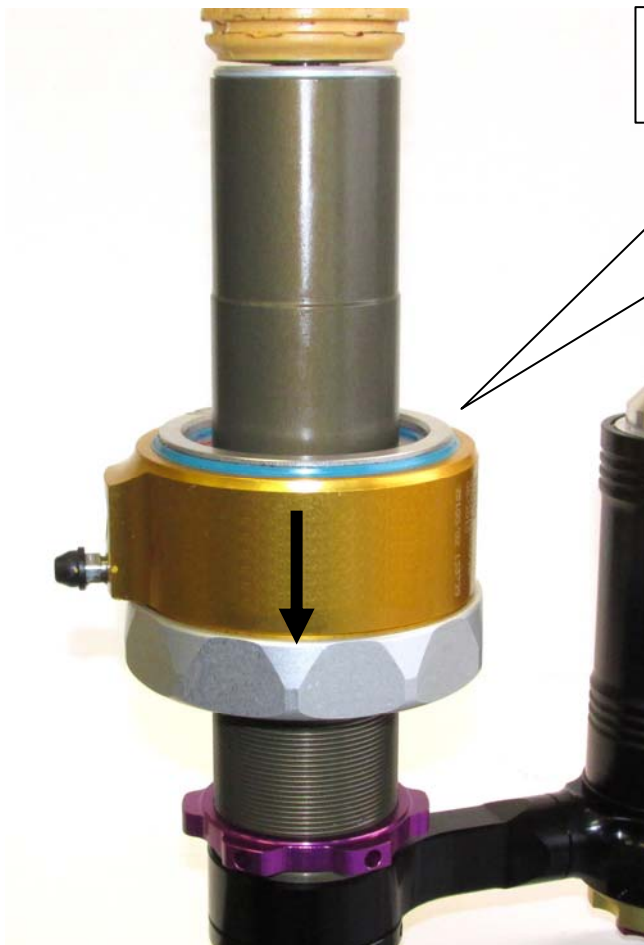

Front axle:

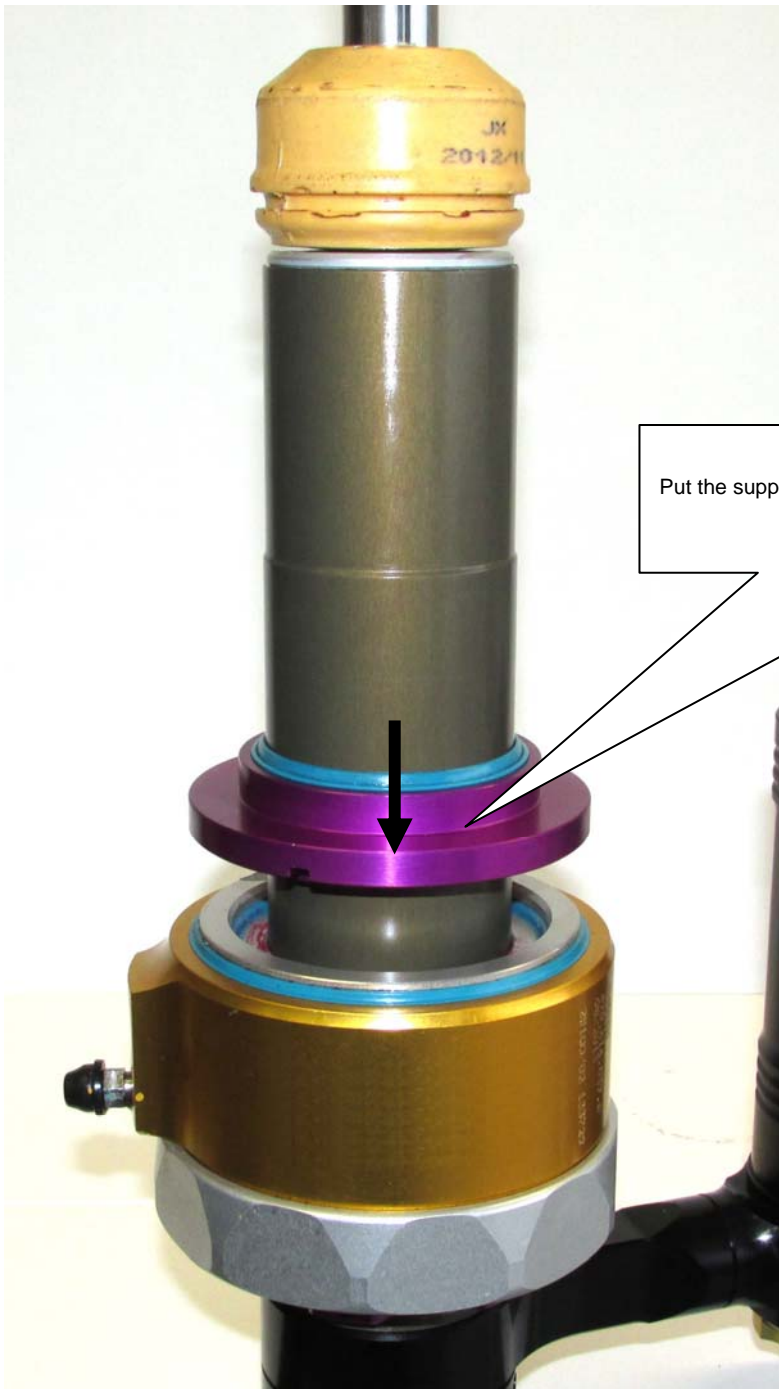

Put the supplied spring perch with the standard wiper ring on the strut.

Front axle:

After this put the springs with intermediate ring, top spring perch with secure half shells on the coil over strut

Install the upper eye with the screws again. Tightening torque for the screws are 35 Nm (26 ft-lb). **Additionally lock the screws with glue. Use "medium strength" glue.**

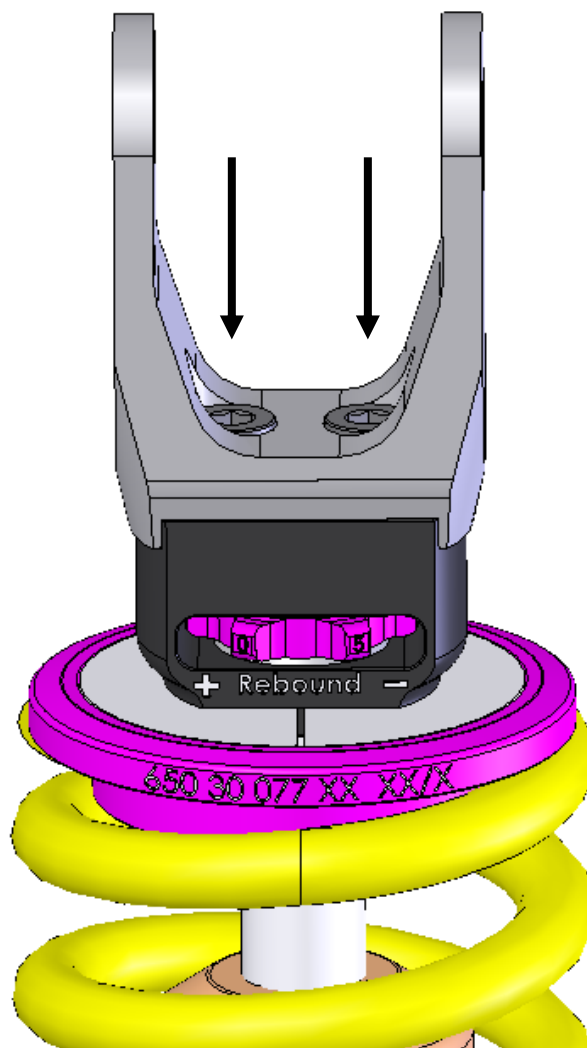

Rear axle:

Supplied coilover strut.

The strut unit has to be installed according to manufacturers instructions settings regarding tightening torque and fixing specifications.

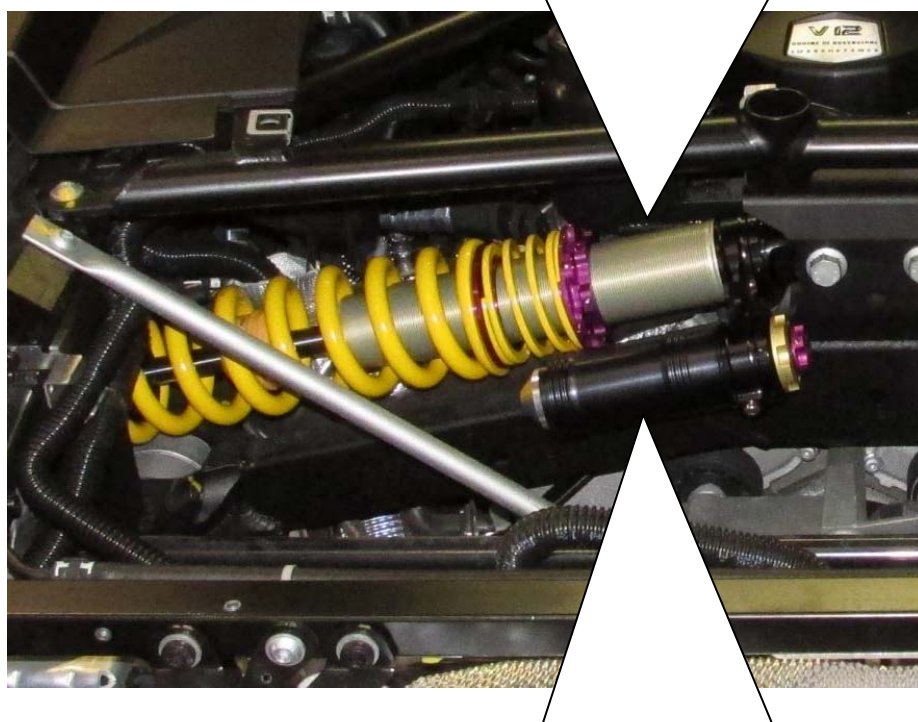

On damper versions with separate reservoirs, mount the reservoir facing to the rear bottom side of the vehicle as shown on the picture.

