

TEILEGUTACHTEN

PART APPROVAL



Parts Approval

Nr. / No. 1228/19
vom / of 05.11.2019



**on the compliance of a vehicle when vehicle parts are properly installed
and fitted to the car in accordance with § 19 Par. 3 No. 4 StVZO**

Modification : *Continuously adjustable suspension system for lowering
the car body*

Part type(s) : **3A7 10 0AM**

Manufacturer : KW automotive GmbH
Aspachweg 14
D-74427 Fichtenberg

Vehicle Manufacturer / Type(s) : Audi Sport, Quattro / 42

max. axle load : VA (*front axle*) 960 kg
HA (*rear axle*) 1195 kg

0. Instructions for vehicle owner

Performance and confirmation without delay of modification acceptance

With the modification the type approval of the vehicle will expire if the modification acceptance provided for in StVZO § 19 Par. 3 is not performed and confirmed without delay or if conditions laid down are not complied with.

After performance of the technical modification, the vehicle must be pre-sented without delay together with the present TÜV parts approval to an officially recognised inspector at a Technical Inspection Centre or to an inspection engineer from an officially recognised inspection organisation to perform and confirm the specified modification acceptance.

Parts Approval

Nr. / No. 1228/19
vom / of 05.11.2019



Compliance with Conditions and Notes

The Conditions and Notes given in III. and IV. must be complied with.

Availability of documents

After the acceptance procedure the certificate with confirmation of the modification acceptance must be carried in the car and presented to authorised persons on demand; this will not apply once the vehicle documents have been amended.

Amendment of vehicle documents

The vehicle owner must apply, in accordance with the provision in the confirmation of modification acceptance, for the competent licensing authority to amend the veh. documents (vehicle registr. documents).

Further conditions can be found in the confirmation of modification acceptance.

I. Field of application

Vehicle manufacturer	Trade name	Vehicle type	Variants and versions	Type approval
Audi Sport	Audi R8 Coupé,	42	alle / all	e1*?/?*0399*.. ab Nachtrag 16 valid from amendment 16
Quattro	Audi R8 Spyder			

The part of the EC type approval number showing *?/?* merely document the current status of the framework directive and are of no significance for this parts approval as long as the parts of the vehicle which are relevant to the lowering of the bodywork have not changed.

Parts Approval

Nr. / No. 1228/19
vom / of 05.11.2019



II. Description of the modification Vorderachse / Front axle

	Pre spring	Main spring
Marking	<i>imprinted EPS – powder coating</i>	<i>imprinted EPS – powder coating</i>
Corrosion protection		
Wire size	4,4 x 7,4 mm	12,6 mm
Outer diameter	oben / top - mm	- mm
	mitte / middle 76 mm	86 mm
	unten / bottom - mm	- mm
Untensioned height	80 mm	170 mm
Number of coils	5,1	6,2
Coil shape	<i>Cylinder, head(s) baselined</i>	<i>Cylinder, head(s) baselined</i>
Spring characteristic	linear	linear

	Spring cup seat (top)	Spring cup seat (bottom)
Max. diameter	80 mm	82 mm
Diameter rest	61 mm	61 mm
Height	16 mm	24 mm
Spring height adjustment	<i>Infinitely adjustable cup seat (Strut)</i>	

	Strut
Damping adjustment (rebound/ compression)	<i>manual</i>
Marking	102 1021

	Rubber or polyurethane foam element
Bump stop	
High/Diameter	50/50 mm
Bump travel	<i>extended by 10 mm</i>

Parts Approval

Nr. / No. 1228/19
vom / of 05.11.2019



Rear axle

	Pre spring	Main spring
Marking	<i>imprinted EPS – powder coating</i>	<i>imprinted EPS – powder coating</i>
Corrosion protection		
Wire size	4,4 x 7,4 mm	12,4 mm
Outer diameter	- mm	- mm
oben / top	76 mm	86 mm
mitte / middle	- mm	- mm
unten / bottom	80 mm	200 mm
Untensioned height	5,1	7,2
Number of coils		
Coil shape	<i>Cylinder, head(s) baselined</i>	<i>Cylinder, head(s) baselined</i>
Spring characteristic	linear	linear

	Spring cup seat (top)	Spring cup seat (bottom)
Max. diameter	80 mm	82 mm
Diameter rest	61 mm	61 mm
Height	16 mm	24 mm
Spring height adjustment	<i>Infinitely adjustable cup seat (Strut)</i>	

	Shock absorber
Damping adjustment (rebound/ compression)	<i>manual</i>
Marking	102 1121

	Rubber or polyurethane foam element
Bump stop	
High/Diameter	35/50 mm
Bump travel	<i>extended by 5 mm</i>

III.

Notes on possible combination with other modifications

III. 1 Wheel/tyre combinations

There are no technical objections against the use of all O. E. wheel/tyre combinations.

If other wheel-/ tyre combinations are used, the examination in accordance with § 21 German Road Traffic Licensing Code - StVZO must be carried out by an officially recognised expert.

III. 2

Aerodynamic devices, special exhaust systems etc.

The dynamic ground clearance is decreased by the provision of special springs/dampers which increase the bump travel of the front and rear axle. In the case of the test vehicle, the min. ground clearance of 80 mm is complied with (below front axle). Care must be taken when driving over humps, barriers and heightened paving or road surfaces.

If special spoilers, aprons and exhaust systems are mounted, attention must be paid to the decreased overhang angle (driving up ramps etc.).

IV. Conditions and Notes

Conditions and notes for the installation shop and modification acceptance

Mounting of the vehicle bodywork components will be performed in accordance with the vehicle manufacturer's specifications which must be included in the delivery and should be carried out by a specialist shop.

The headlight adjustment has to be checked.

After modification an axle alignment must be carried out on the vehicle.

The bump stops (rubber or polyurethane foam element) must correspond to the descriptions of this report. Additional travel limiters are not allowed.

Parts Approval

Nr. / No. 1228/19
vom / of 05.11.2019



When installing the coilover kit in vehicles with electronic damping control - depending on the technical specification of the vehicle - the electronic dampers need to either

- be deactivated by the use of "KW simulating plugs" respectively by changing the software or
 - to be connected with the plugs of the serial dampers via the "KW connectors" of the KW dampers.
- The simulating plugs which optionally can be used, consist of a plug-in sleeve with an integrated electric coil. These plugs are to be connected with the vehicle-mounted connectors instead of the serial dampers in order to simulate the situation that the serial ones would still be installed, furthermore in order to rule out an error signal.

Use of the lowering kit on vehicles with levelling system is not permitted.

The vehicle height must be laid down in the vehicle documents in box 20. The precise measure of the lowering will depend on the specific vehicle tolerances, tyre size and vehicle version.

Maße / dimensions (mm)

Vehicle	adjustment range (min. - max.)		Clearance		Size of lowering	
	VA/front ¹⁾	HA/rear ¹⁾	VA/front ²⁾	HA/rear ²⁾	VA/front	HA/rear
Audi R8 Coupé Quattro	255 – 270	120 – 140	335	340	5 – 25	15 – 35
Audi R8 Spyder Quattro	255 – 270	120 – 140	335	340	0 – 20	10 – 30
Audi R8 Coupé 2WD	250 – 265	120 – 140	335	340	5 – 25	15 – 35
Audi R8 Spyder 2WD	250 – 265	120 – 140	335	340	0 – 20	10 – 30

1) distance from the spring rest to the nearest fastening screw

2) Minimum distance from wheel centre to wheelhouse rim

Amendment of vehicle documents:

Amendment of the vehicle documents is only necessary the next time the approval authority has to do with the vehicle documents. The following example is suggested for the entry:

V. Basis of tests and test results

*The test vehicle and the modification parts were subjected to a test in accordance with the test conditions regarding raising / lowering of vehicles contained in VdTÜV Merkblatt 751 (26.01.2018).
The test conditions were fulfilled.*

VI. Annex: none

Parts Approval

Nr. / No. 1228/19
vom / of 05.11.2019



VII. Concluding certification

It is hereby certified that the vehicles described under field of application satisfy the regulations of StVZO in the current version after modification and performed and confirmed modification acceptance, provided the conditions/notes given in the present TÜV approval are observed.

The manufacturer KW automotive GmbH maintains a quality management system according to ISO 9001:2015 (Certificate Registration No.: 12 100 22913 TMS).

The parts approval may only be reproduced and passed on by the manufacturer in its unabbreviated form.

The TÜV parts approval shall cease to be valid if technical modifications are made to the vehicle part or if modifications made to the vehicles described affect use of the part and in the case of any changes to the statutory specifications.

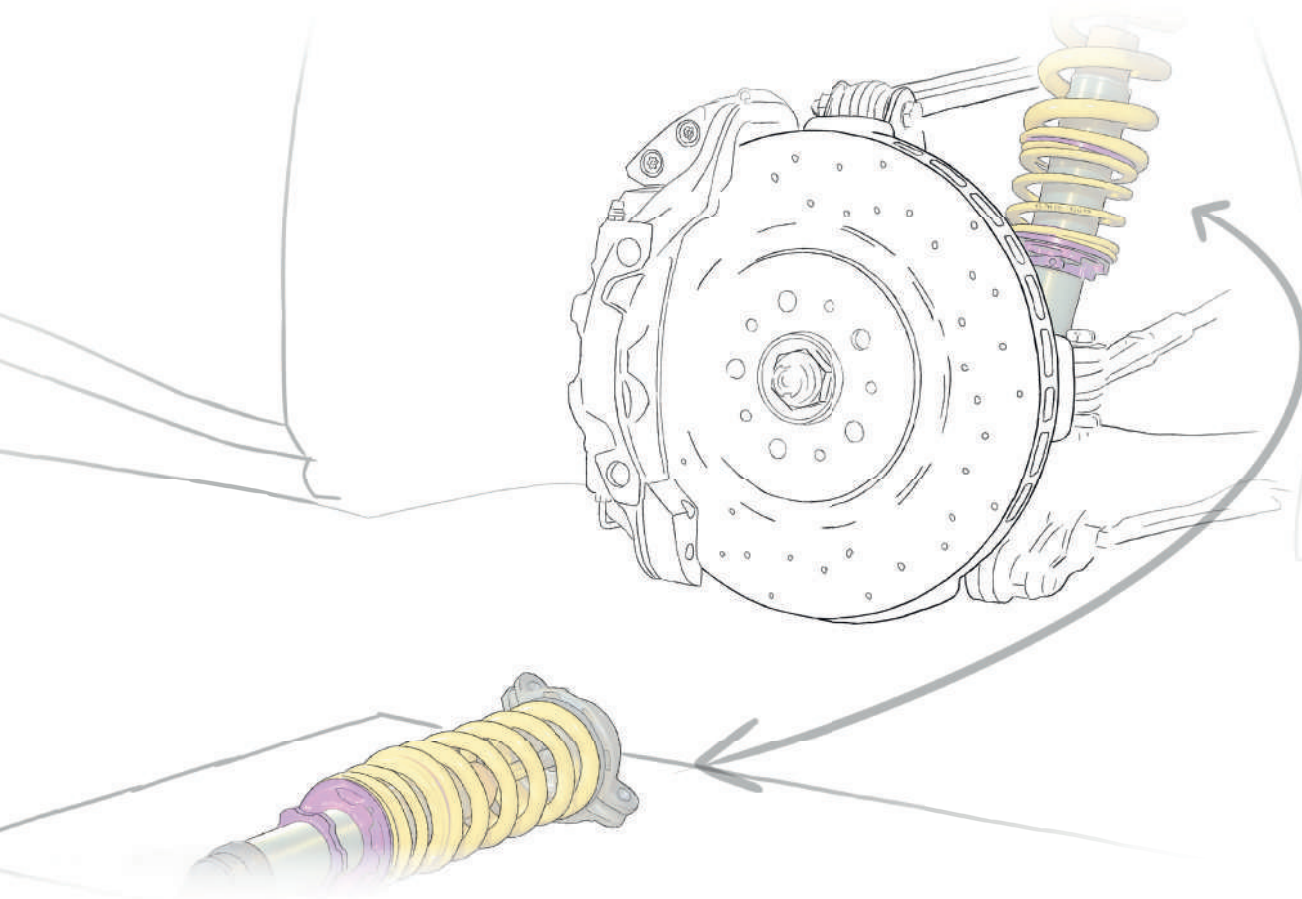

INSTALLATION INSTRUCTIONS





INSTALLATION INSTRUCTIONS

**Before you begin installation,
please read the following carefully:**

- **Ensure that certificate matches the vehicle specifications (front vehicle identification number (VIN)) etc...**
- **The suspension components must match the suspensions application specifications (springs and shock/struts identification numbers).**
- **The instructions have to be strictly observed.**

KW Coilovers for automobile suspensions are designed for easy installation. If not otherwise stipulated in these instructions, all suspension components are installed and removed in accordance with the manufacturer's specifications for installing and removing standard springs and damper components. At the time of printing all instructions and specifications are correct.

Technical data	Coilover part number 3A7 10 0AM			
Vehicle model	Audi R8 Coupé, R8 Spyder Quattro type 42		max. permissible front axle load: 960 kg	
	front axle		rear axle	
Spring signature	10-60-80 / 120-170*		10-60-80 / 90-200*	
Coilover strut / Shock absorber signature	102 1021		102 1121	
Approximate distance measurement A Front axle: Fastening screw - spring contact area Rear axle: Seating height adjustment - spring contact area or fastening screw - spring contact area	min:	max:	min:	max:
	255 mm / 10,0 inch	270 mm / 10,6 inch	120 mm / 4,7 inch	140 mm / 5,5 inch
Approximate measurement* B in mm / inch: wheel hub center to fender edge	min:		min:	
	335 mm / 13,2 inch		340 mm / 13,4 inch	

Vehicle model	Audi R8 Coupé, R8 Spyder 2WD type 42		max. permissible front axle load: 960 kg	
	front axle		rear axle	
Spring signature	10-60-80 / 120-170*		10-60-80 / 90-200*	
Coilover strut / Shock absorber signature	102 1021		102 1121	
Approximate distance measurement A Front axle: Fastening screw - spring contact area Rear axle: Seating height adjustment - spring contact area or fastening screw - spring contact area	min:	max:	min:	max:
	250 mm / 9,8 inch	265 mm / 10,4 inch	120 mm / 4,7 inch	140 mm / 5,5 inch
Approximate measurement* B in mm / inch: wheel hub center to fender edge	min:		min:	
	335 mm / 13,2 inch		340 mm / 13,4 inch	

Calculating the adjustment range (distance measurement A) : (Photos are examples only)

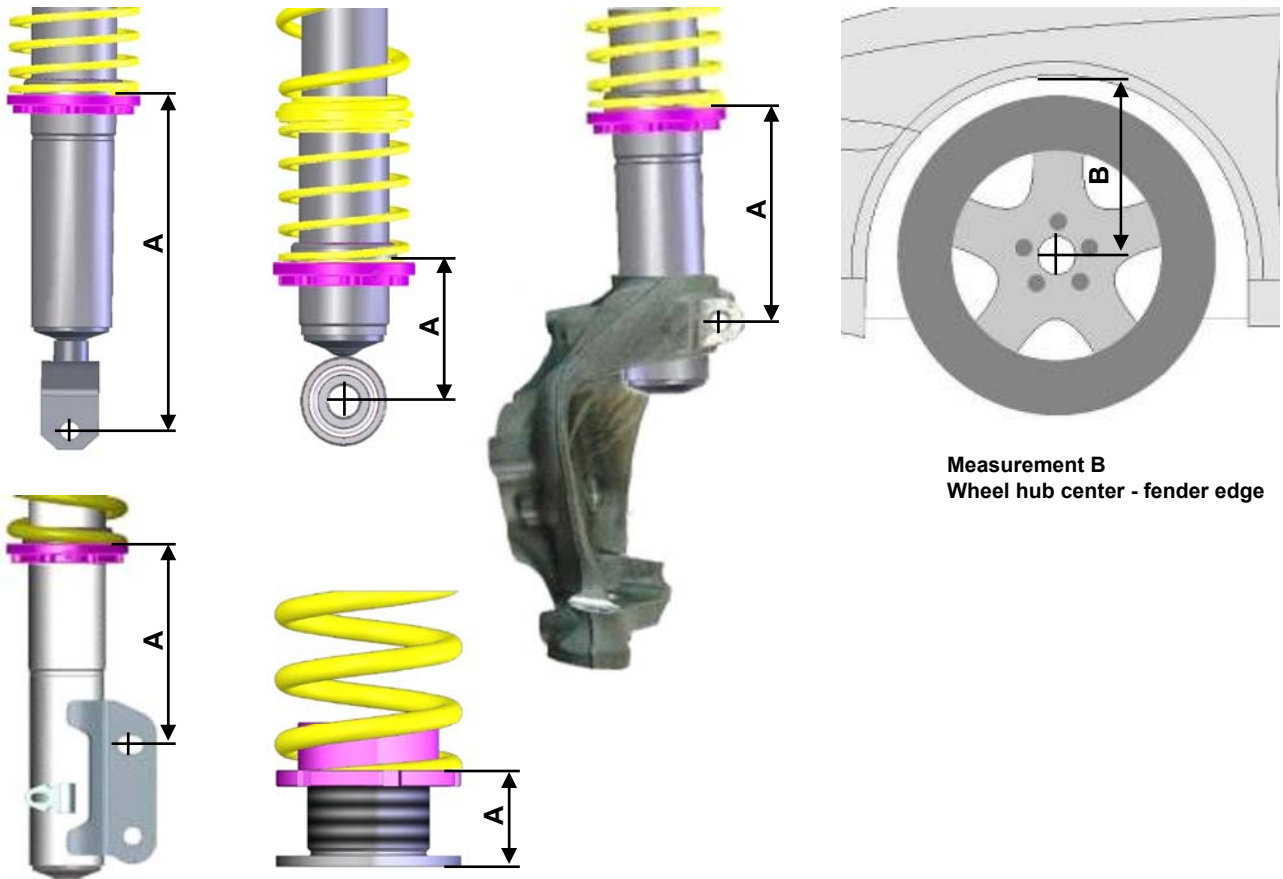

Measurement B
Wheel hub center - fender edge

Please enter the adjusted height of the modified car into the list:

Coilover part no	Vehicle type	Measurement A		Wheel hub center - fender edge Measurement B	
		Front	Rear	Front	Rear

* **IMPORTANT:** The allowable measurement between wheel hub center and fender edge as indicated above, may not exceed these measurements when using standard fenders.

Danger:

Always follow the latest accident prevention regulations (not applicable for North America) for each step to prevent any serious bodily harm or injury.

1. We recommend the use of a vehicle hoist or lift when installing the suspension. If a lift is not available and jacking equipment is used, make sure that the vehicle is secured with commercial wheel blocks and jack stand to ensure safety.
2. The suspension components may only be installed by trained technical personnel using the proper tools.
3. The General Installation instructions, as well as the Technical Inspectorate documents must be read BEFORE attempting installation.
4. Never use impact wrenches or guns to install or remove shock absorber piston hardware.
5. Never disassemble or cut open shock absorbers and/or shock absorber inserts. They contain oil under pressure. Danger of explosion.
6. Before driving on public highways, carry out the work steps on page 7, items 11 through 14 after installation.
7. The suspension regulation (when available) needs to be disabled through an authorized dealer.
8. Please take care in any case that fittings (for example fittings of shock absorber housings or fittings of the lower control arm in the housing of the wheel bearing) are free of dust and oil. (see manufacturer guideline)

General Instructions for Use:

1. When adjusting the vehicle height, make sure that the threads are clean and free of debris. After initial cleaning, move the perch by 10 mm (0.4 Inches) downwards, and then clean the area that you desire to adjust the perch (up or down).
2. During height adjustments on separate shock and spring systems, remove the perch from the vehicle to adjust the height.
3. After adjusting the vehicle height, repeat steps 11 through 14 from page 7.
4. In the area of the piston rod and the sealing package of the new and used damper there might be oil and grease collected. This could either be caused by using a special black grease during assembling the washer or due to accumulation of streak oil. Further more oil is used during assembling the cartridge and rod guide. There is no reason of worrying about and damage, as in this area also dust and dirt used to be collected.

Tightening torque for the piston rod nut:

M8 = **25Nm (18 ft-lb)**, M10x1 = **20Nm (15 ft-lb)**, M10x1,25 = **20Nm (15 ft-lb)**, M12x1,25 = **35Nm (26 ft-lb)**,
M12x1,5 = **40Nm (29 ft-lb)**, M14x1,5 = **50Nm (37 ft-lb)**, M16x1,5 = **50Nm (37 ft-lb)**

General Mounting Specifications:

1. We recommend the use of a vehicle hoist or lift when installing the suspension.
2. **Caution:** If the vehicle is equipped with ride height sensors, they should be removed before removal of struts or dampers, otherwise damage may occur.
3. The struts should be removed as specified by manufacturer's instructions.
4. Manufacturer recommended tools for removal of the original struts, or a suitable spring compressor, must be used in order to remove most factory mounted suspension systems.
5. Mount the complete suspension system as described on the following pages.
6. Never use impact drivers to install nuts on the piston rods as permanent damage may occur. It is imperative that you do not damage the piston rod surface, through use of pliers etc, as the smallest damage will result in seal damage, and will not be covered under warranty.
7. Stay within the lowering range specified in the table on page 3.
Example: With a specified range of 20 - 60 mm (0.8 - 2.3 Inches), 40 mm (1.5 Inches) is your height adjustment range.
8. Ensure that the set screw on each spring collar is tightened to prevent movement of the spring perch. On vehicles with separate shock/spring combinations, no set screw is necessary.
Caution: Do not over tighten the set screw. Maximum torque is 1 - 2 Nm (0.74-1.47 ft-lb).
9. Install the suspension components in the vehicle as specified by the vehicle manufacturers in their document.
10. Except as noted, all torque values must comply with manufacturer recommended specifications.
11. After assembly and installation is complete, the vehicle should be rolled onto level ground. Once on level ground, measure the vehicle height and adjust to the customer's requirements, within the prescribed lowering range.
Caution: Wheel hub center—wheel arch maximum measurement in the table of page 3 must not be exceeded! Also take into account minimum road clearances specified in the table on page 7 (only valid for Germany!).
Caution: It is common for the vehicle suspensions to settle by an additional 5 - 10 mm (0.2 - 0.4 Inches)
12. Examine the clearance between the tires and the suspension over the full range of motion of the wheel. The minimum clearance between the suspension and the tire is 4 mm (0.16 Inches). If this clearance is less than 5 mm (0.2 Inches), wheel spacers may be necessary. With strut designs that are located close to the wheel, but that have no steering functions, use 100 mm (3.9 Inches) spacers on diagonally opposed wheel (e.g. front right, rear left). In this position, you must be able to achieve the minimum clearance required. You can also check the clearance between tire and body.
Caution: With torsion beam trailing arm axles, this method is not sufficient. The wheel must be under full load as well as test driven to properly calculate the clearances of 5 mm (0.2 Inches) from any other components.
13. The geometry of the suspension needs to be adjusted according the regulations of the vehicle manufacturer. If a value cannot be reached due to the difference in the height, a optimal value next to the tolerance range of the vehicle manufacturer needs to be adjusted.
14. All components that are controlled by vehicle ride height (e.g. headlights, brake bias regulator etc.) must be adjusted as specified by the vehicle manufacturer instructions and procedures.
15. For vehicles with ESP, DSC or EPC your new suspension components may cause an engine fault code to appear. This is only temporary as the vehicle electronics adjust to the new components/height. On some models this will end after driving approximately 3-5 miles, or through turning the steering wheel from full left to full right. On other models, this must be reset through the factory diagnostic port by a qualified technician.
16. If Vehicles have Driver Assistant Systems and the ride high is lowered by an increase of the compression travel, it must be proofed that all relevant sensors (like Radar Sensor or Camera Systems) be adjusted according to the Manufacture Specifications

Front axle:

. Supplied coilover strut.



Front axle:

Dismantle the OEM Strut by according to the vehicle manufacturer.

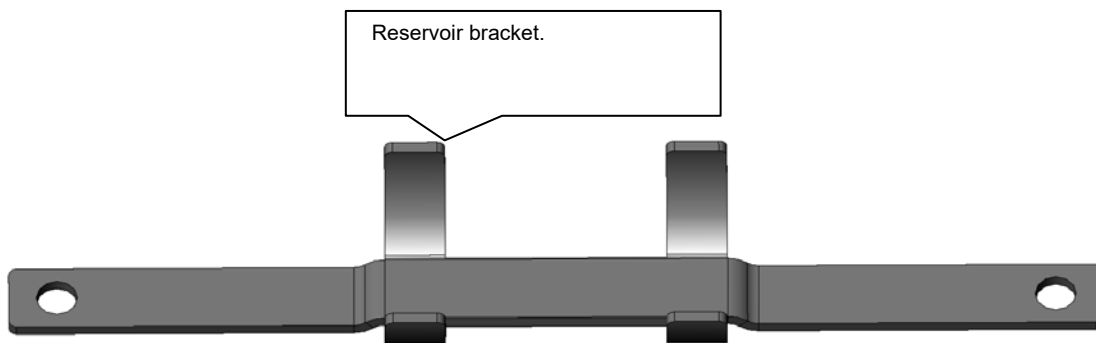

Loosen the screws on the control arm and install the supplied bracket for the reservoir tank. Pushed up the wishbone (without the strut) to disassemble the screws!
The tightening torque of the attachment, please refer to the vehicle manufacturer.



Front axle:

The strut unit has to be installed according to manufacturers recommended settings regarding tightening torque and fixing specifications.



The connection of the reservoir must facing to the front of the vehicle.

Front axle:

Fix the reservoir tank with the supplied cable ties as shown in the picture. The adjustment must show towards to the front of the vehicle.

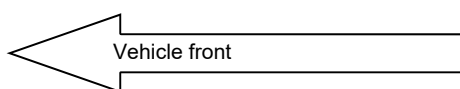
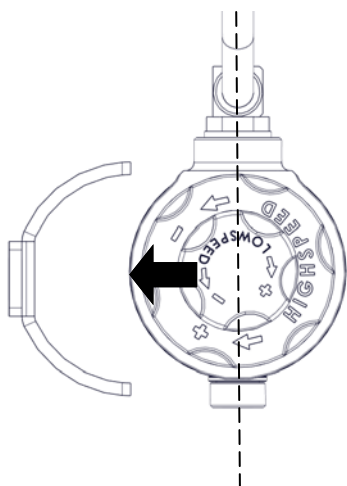

Rear axle:

Until model

2019

Supplied coilover strut.



Rear axle:

The strut unit has to be installed according to manufacturers recommended settings regarding tightening torque and fixing specifications.



The connection of the reservoir must facing to the inside of the vehicle.

Rear axle:

Drill a thread for the installation of the reservoir tank into the vehicle frame. For this drill a hole at the marked point with 5.0mm / 0,2inch and cut a thread M6.



Use safety glasses!

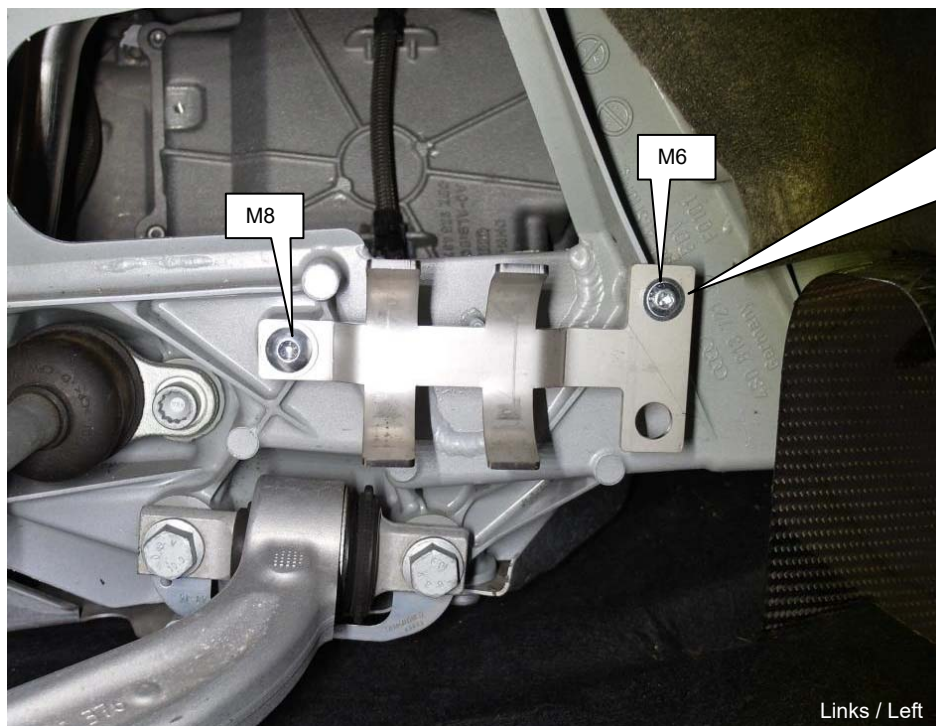

Rear axle:

Mount the bracket with the screws on the vehicle frame. The tightening torque for **M6 = 10Nm**, **M8 = 15Nm**.

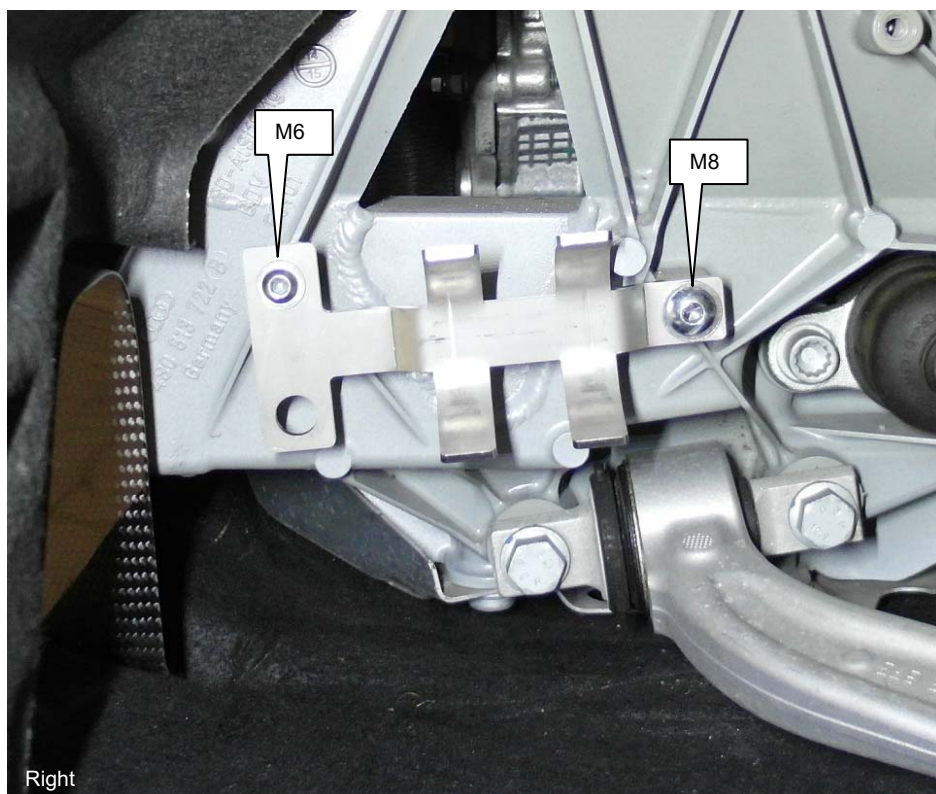

Rear axle:

Fix the reservoir tank with the supplied cable ties as shown in the picture. The adjustment must shows towards to the rear of the vehicle.

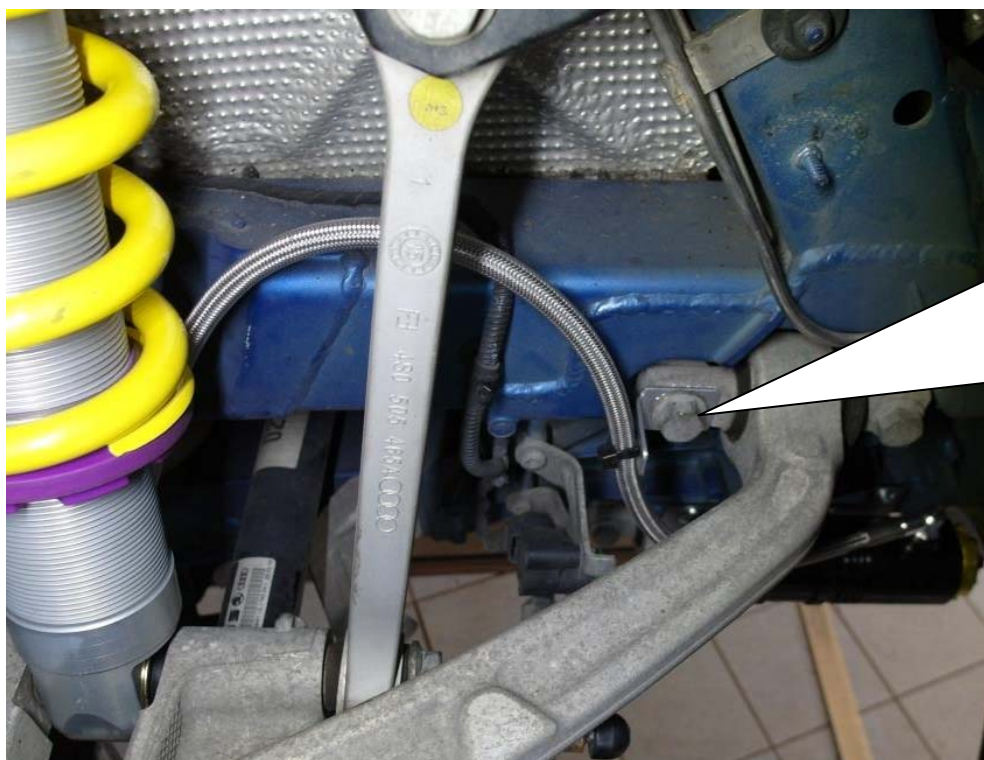
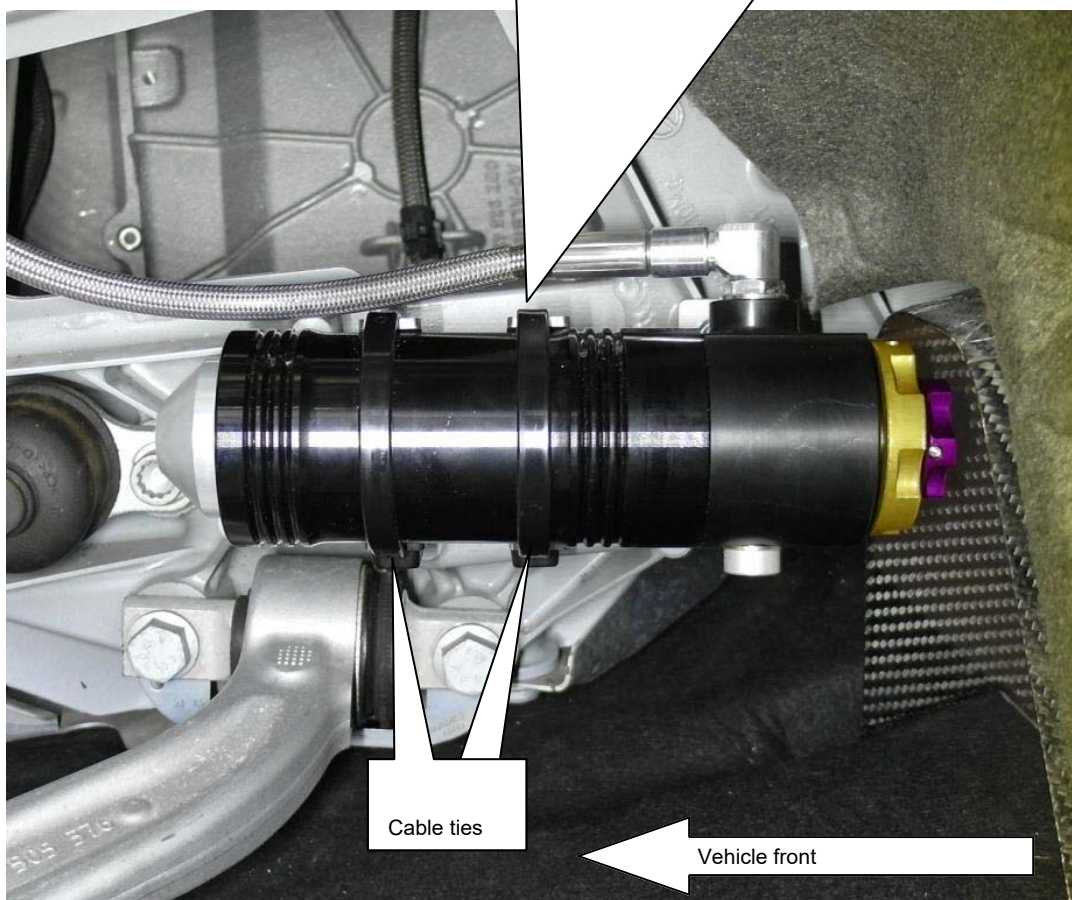

Loosen the screw on the control arm and install the supplied bracket. The tightening torque of the attachment, please refer to the vehicle manufacturer. Then fix the line with a cable tie.

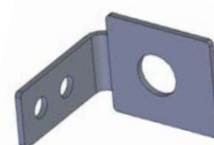

Rear axle:

From model

2019

Supplied coilover strut.



Rear axle:

The strut unit has to be installed according to manufacturers recommended settings regarding tightening torque and fixing specifications.

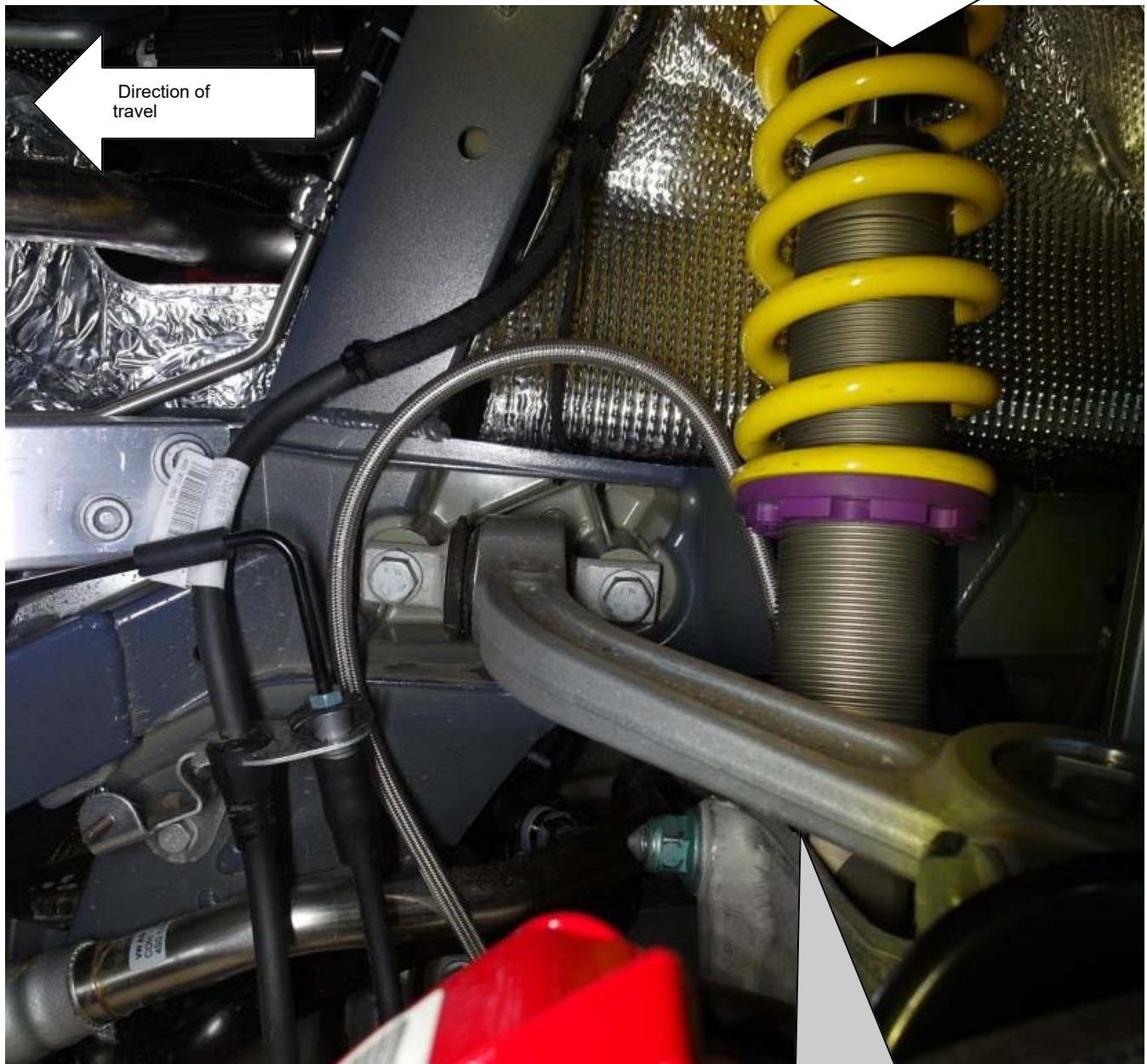

The connection of the reservoir must facing to the inside of the vehicle.

Rear axle:

Fix the reservoir tank with the supplied cable ties on the bracket for the underbody as shown in the picture. The adjustment must show towards to the front of the vehicle.

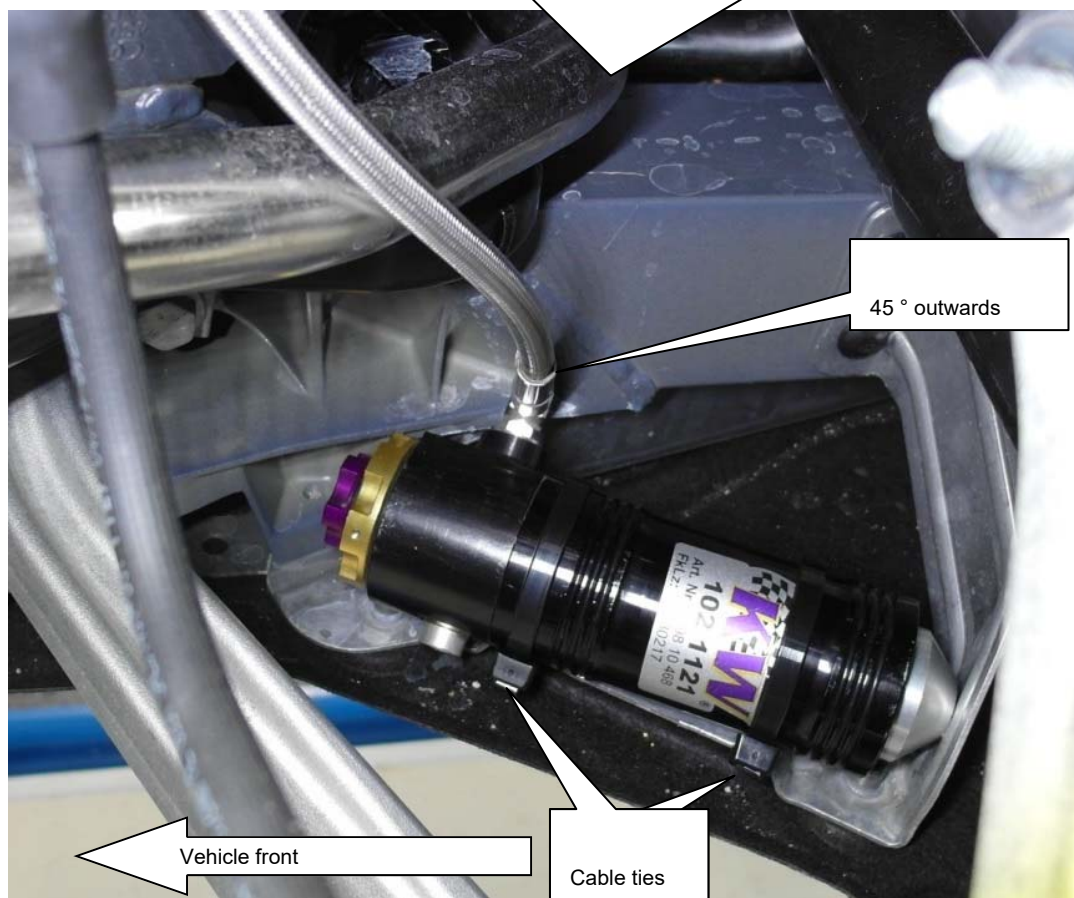

Loosen the screw on the control arm and install the supplied bracket. The tightening torque of the attachment, please refer to the vehicle manufacturer. Then fix the line with a cable tie.



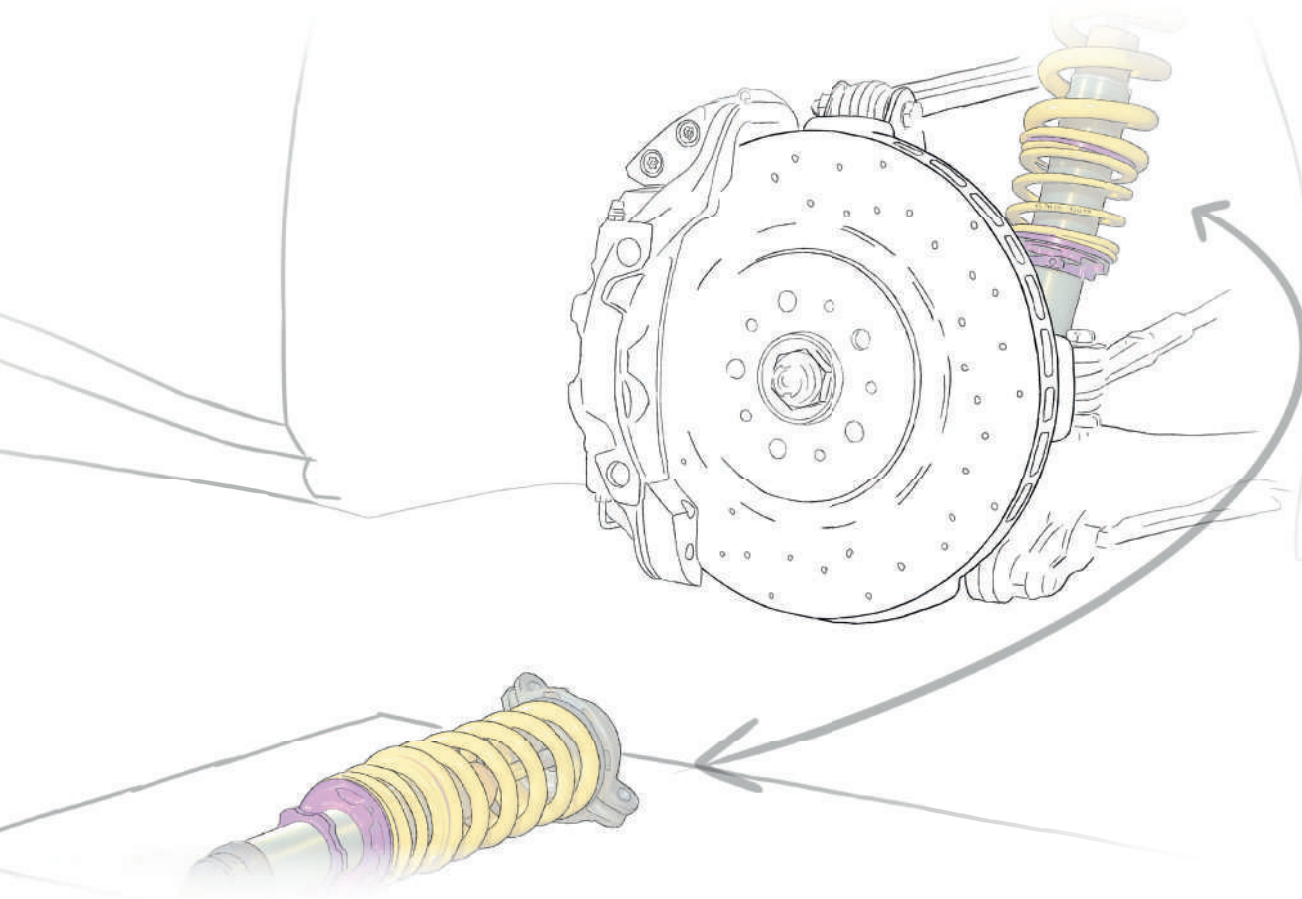

INSTALLATION INSTRUCTIONS



Installation Instructions		<i>KW automotive</i>	
Instruction No.	685 10 489	Date	14.02.2017

KW automotive

685 10 489
INSTALLATION INSTRUCTIONS
Cancellation kit

Installation Instructions			<i>KW automotive</i>	
Instruction No.	685 10 489		Date	14.02.2017

Front axle righth:

Run the standard damper control wire to the canceller connector. Insert the connector into the canceller connector until it locks. Fix the canceller with supplied cable ties on the vehicle chassis.



Cable ties

Cable ties



Installation Instructions			<i>KW automotive</i>	
Instruction No.	685 10 489		Date	14.02.2017

Front axle left:

Run the standard damper control wire to the canceller connector. Insert the connector into the canceller connector until it locks. Fix the canceller with supplied cable ties on the vehicle chassis.



Cable ties

Cable ties



Installation Instructions		<i>KW automotive</i>	
Instruction No.	685 10 489	Date	14.02.2017

Rear axle righth:

Run the standard damper control wire to the canceller connector. Insert the connector into the canceller connector until it locks.

Mount the canceller with the supplied edge clips on the chassis edge.
Fix the cable with cable ties.

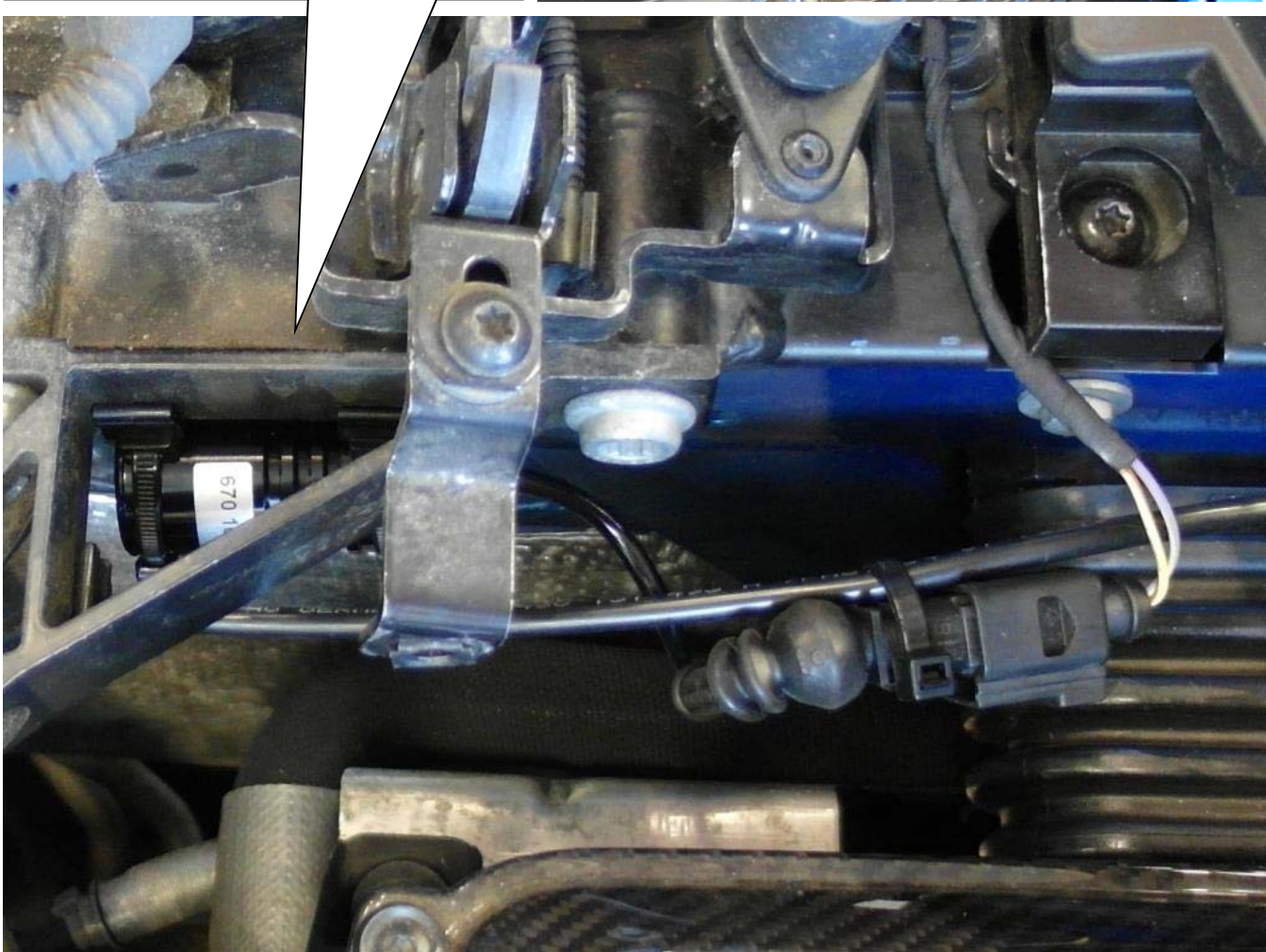
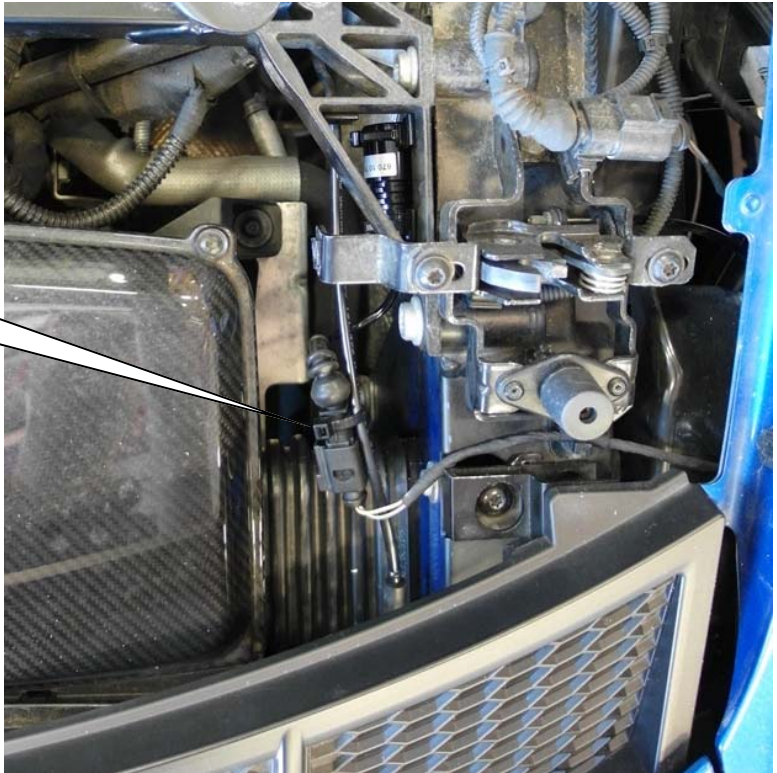

Installation Instructions			KW automotive	
Instruction No.	685 10 489		Date	14.02.2017

**Hinterachse links /
Rear axle left:**

Run the standard damper control wire to the canceller connector. Insert the connector into the canceller connector until it locks.

Mount the canceller with the supplied edge clips on the chassis edge.
Fix the cable with cable ties.

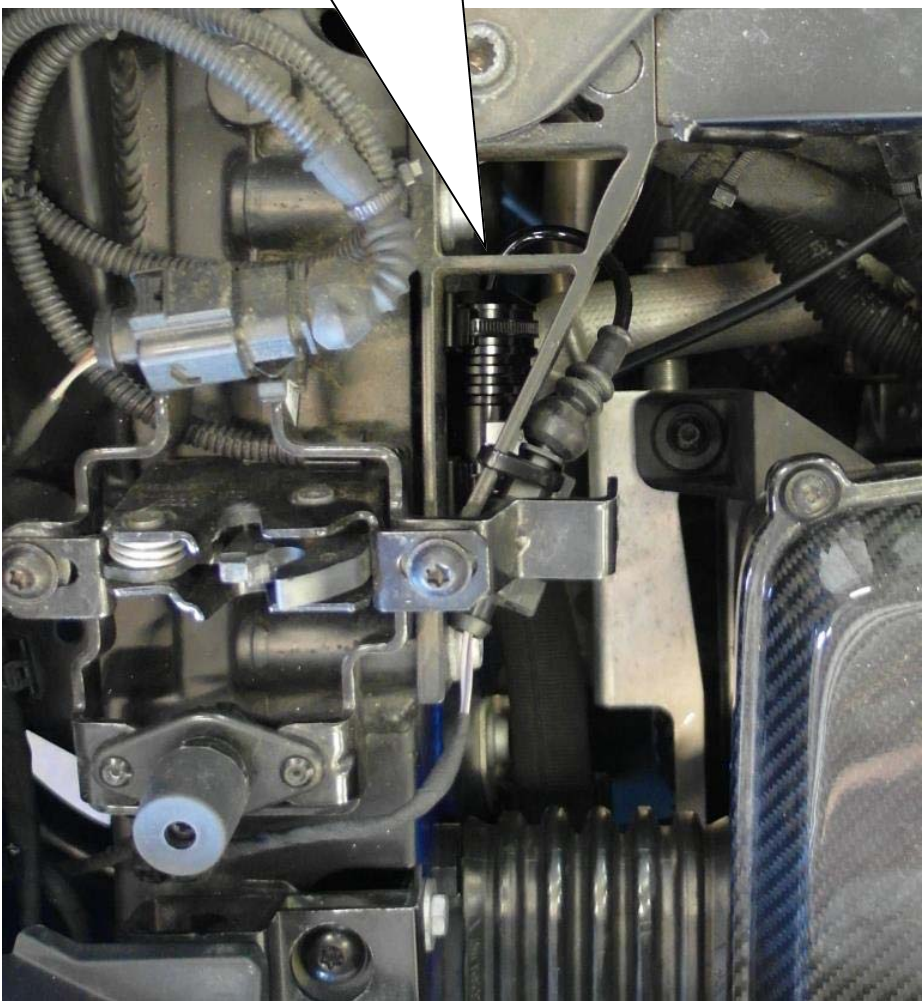

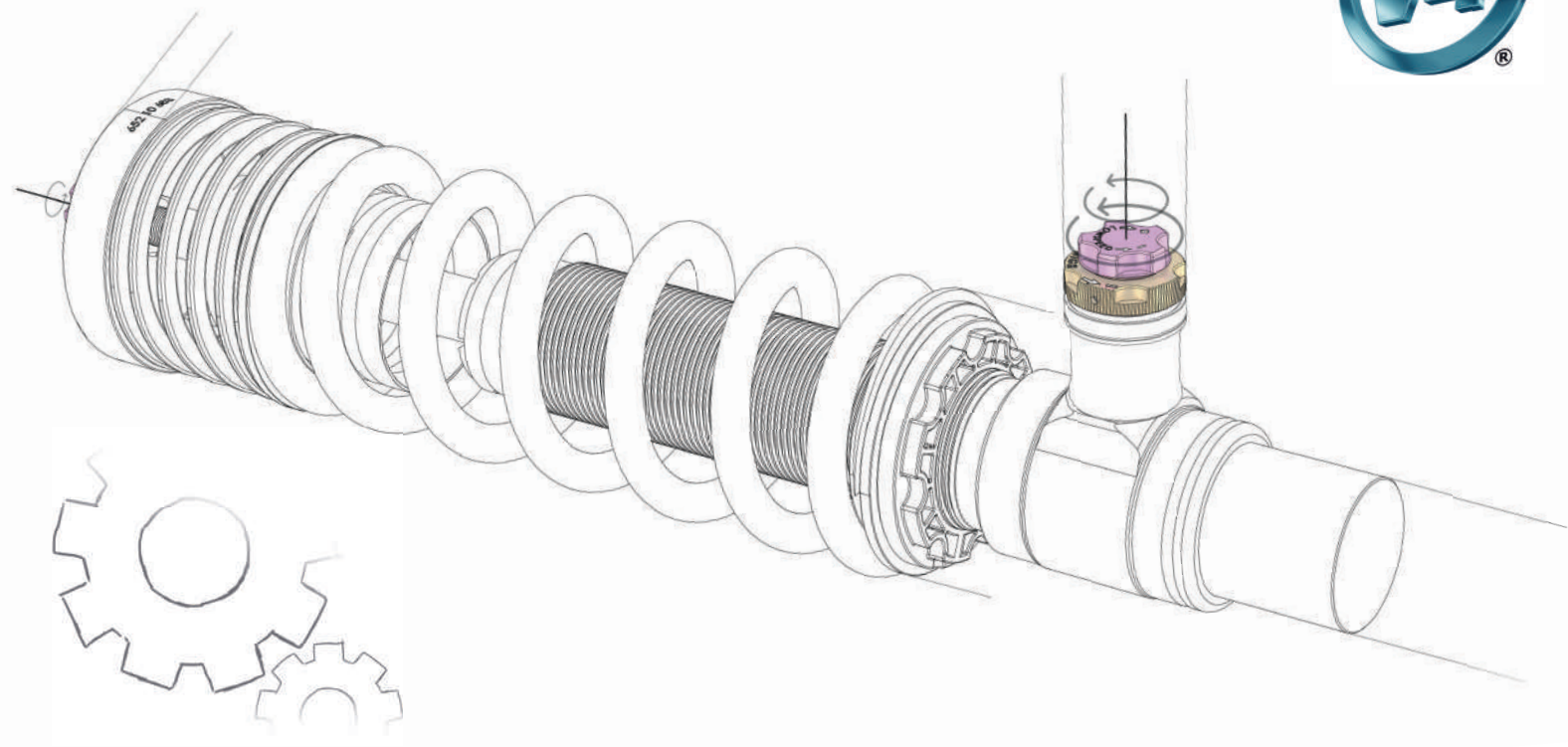

SETUP MANUAL



KW automotive

Set Up Manual KW V4

No. 685 79 410

Our 3-way adjustable damper is separate and independently adjustable in compression and rebound.

Rebound:

The rebound setting can be adjusted at the upper end of the piston rod via an adjustment wheel (version 1 and version 2)

In version 3 (upside-down version), the rebound adjuster is located at the lower end of the damper.

In all versions, the adjustment will be done based on closed status (max. hard). The closed status is reached when the adjustment wheel is completely turned to hard (+). ("0" on the adjustment wheel).

The effective adjustment range is 0 – 16 clicks open.

Never apply force to the adjusting mechanism of the shock absorber. As soon as you reach the end of the adjustment range, you will recognize a certain resistance. Stop turning to avoid damage to the bottom valve.

Impact of the rebound

Little rebound power improves driving comfort during slow driving, but reduces stability and control accuracy at fast driving, especially with appropriate adjustment.

High rebound power improves the handling at the front axle, but possibly reduces the grip. The driving comfort will be extremely limited.

Version 1 (Adjustment wheel for clipping on):

The adjustment wheel has to be put on the piston rod for adjusting the dampers. With clockwise rotation of the adjustment wheel the rebound damping will become harder. With anti-clockwise rotation the rebound damping will become softer. The click directions are labeled with "+" (harder) and "-" (softer) on the adjustment wheel.

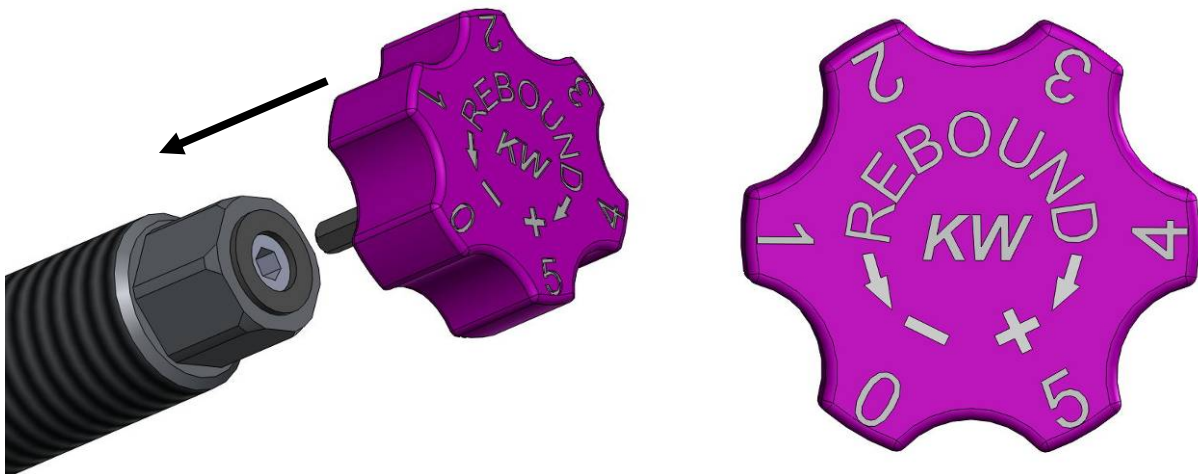

Version 2 (Integrated adjustability):

The numbers on the adjustment wheel show the current setup and facilitate the setup of the dampers. The click direction, in which the rebound becomes harder respectively softer, is marked on the adjustment header with a "+" (rebound becomes harder) and a "-" (rebound becomes softer). The numeration on the adjustment header is one sided. On the same side of the header, the valid adjustment stage can be found as a number on the adjustment wheel.

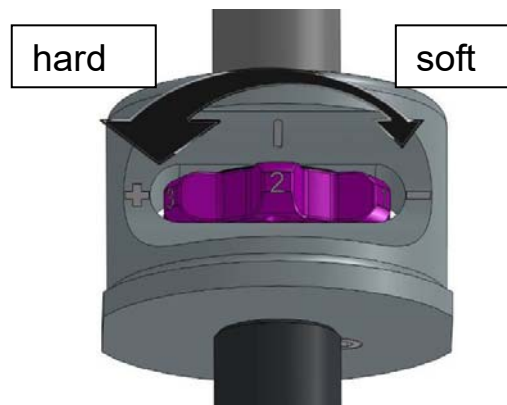
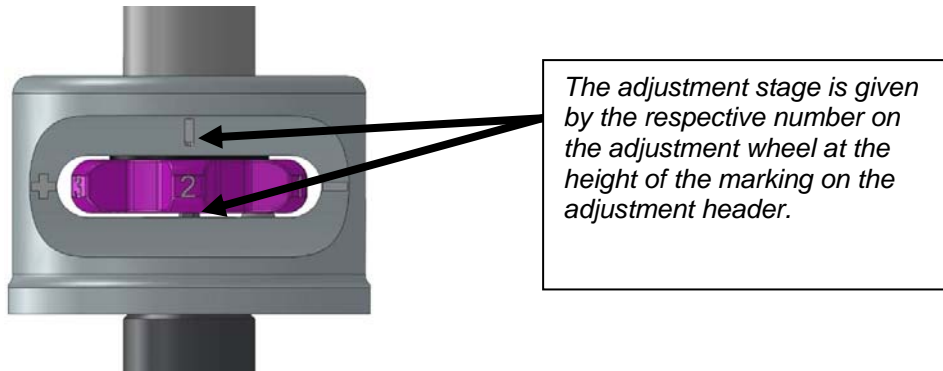
**Version 3 (Upside-down):**

The adjusting wheel is fixed to the bottom of the damper. With clockwise rotation of the adjustment wheel the rebound damping will become harder. With anti-clockwise rotation the rebound damping will become softer. The click directions are labeled with "+" (harder) and "-" (softer) on the adjustment wheel.

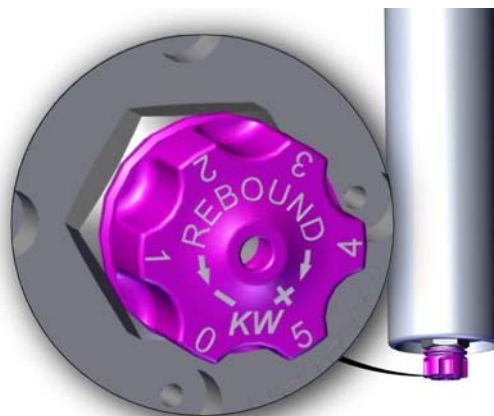
**Bump:**

The compression adjustment is done at the reservoir or the damper housing using the adjustment wheels. The adjustment will be done based on the closed valve (max. hard). The closed valve can be reached by turning the adjustment wheel completely too hard (+).

The maximum effective adjustment is

- 0 – 13 clicks in low speed and
- 0 – 14 clicks in highspeed.

Influence of low speed compression adjustment

Compression adjustment has significant influence on handling and driving behaviour.

In general there is to say:

A harder compression adjustment on the front axle makes the car more precise and more aggressive, whereas a softer adjustment favours a more forgiving steering behaviour.

Harder compression adjustment on the rear axle makes the car more stable on fast direction changes and helps if it has too much tendency to over steer. On the other hand, a softer compression damping makes the rear axle looser and might improve the handling if the car was too tight or had too much understeering before.

However, too much compression might cause uncomfortable and loud tyre role and/or costs grip.

Due to the digressive characteristic of the high speed section in our compression valve, hard adjustments do barely affect ride comfort on hard kerbs and bumps.

Never apply force to the adjusting mechanism of the shock absorber. As soon as you reach the end of the adjustment range, you will recognize a certain resistance. Stop turning to avoid damage to the bottom valve.

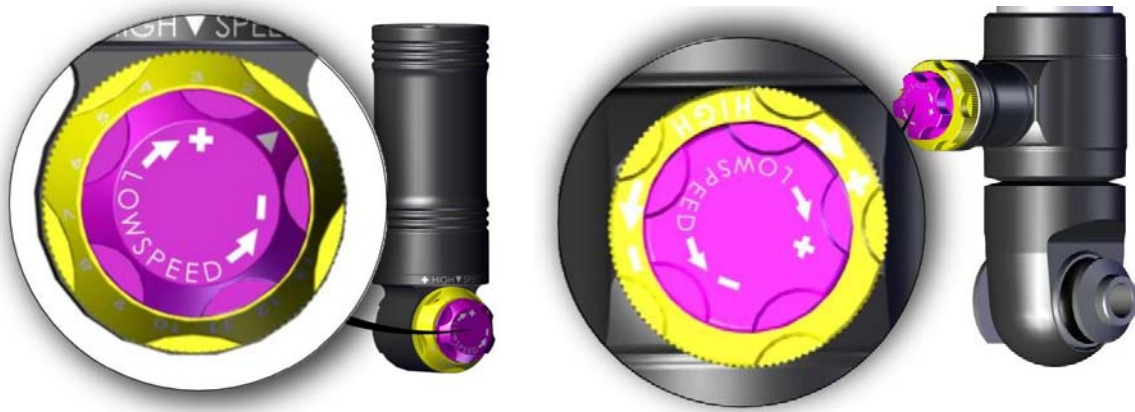
**Delivery status**

Our dampers will be delivered always in performance setup. This basic setup was specified for your car at the front and rear axle. In case of reset the dampers into the basic setup, the values of the following table are valid.

Our recommendation performance setup for your car to start with (delivery):

Front axle	Rebound:	10	Clicks open
-------------------	----------	----	-------------

Rear axle	Rebound:	10	Clicks open
------------------	----------	----	-------------

Front axle	Bump low:	2	Clicks open	Bump high:	10	Clicks open
-------------------	-----------	---	-------------	------------	----	-------------

Rear axle	Bump low:	3	Clicks open	Bump high:	5	Clicks open
------------------	-----------	---	-------------	------------	---	-------------

Our recommendation street setup for your car with:

Front axle	Rebound:	16	Clicks open
-------------------	----------	----	-------------

Rear axle	Rebound:	16	Clicks open
------------------	----------	----	-------------

Front axle	Bump low:	5	Clicks open	Bump high:	8	Clicks open
-------------------	-----------	---	-------------	------------	---	-------------

Rear axle	Bump low:	6	Clicks open	Bump high:	12	Clicks open
------------------	-----------	---	-------------	------------	----	-------------

Example: Adjusting the basic setup rebound front axle:

Basic setup rebound is 9 clicks opened in this example.

First, the rebound needs to be turned clockwise, direction "hard" (+). Afterwards, the adjustment wheel needs to be turned anti-clockwise, direction "soft" (-) until the adjustment wheel clicks 9 times.

The adjustment wheel now shows the number 3.

The single adjustment positions are described in the following chart.

