



INSTALLATION INSTRUCTIONS

77-2585KS FORD 2012-14 F150 V6-3.7L

NOTE: This kit was not designed to fit vehicles with a body lift.

TOOLS NEEDED:

Flat blade screw driver
3/4" wrench
9/16" wrench
T20 torx
4mm Allen key
3mm Allen key
Pliers

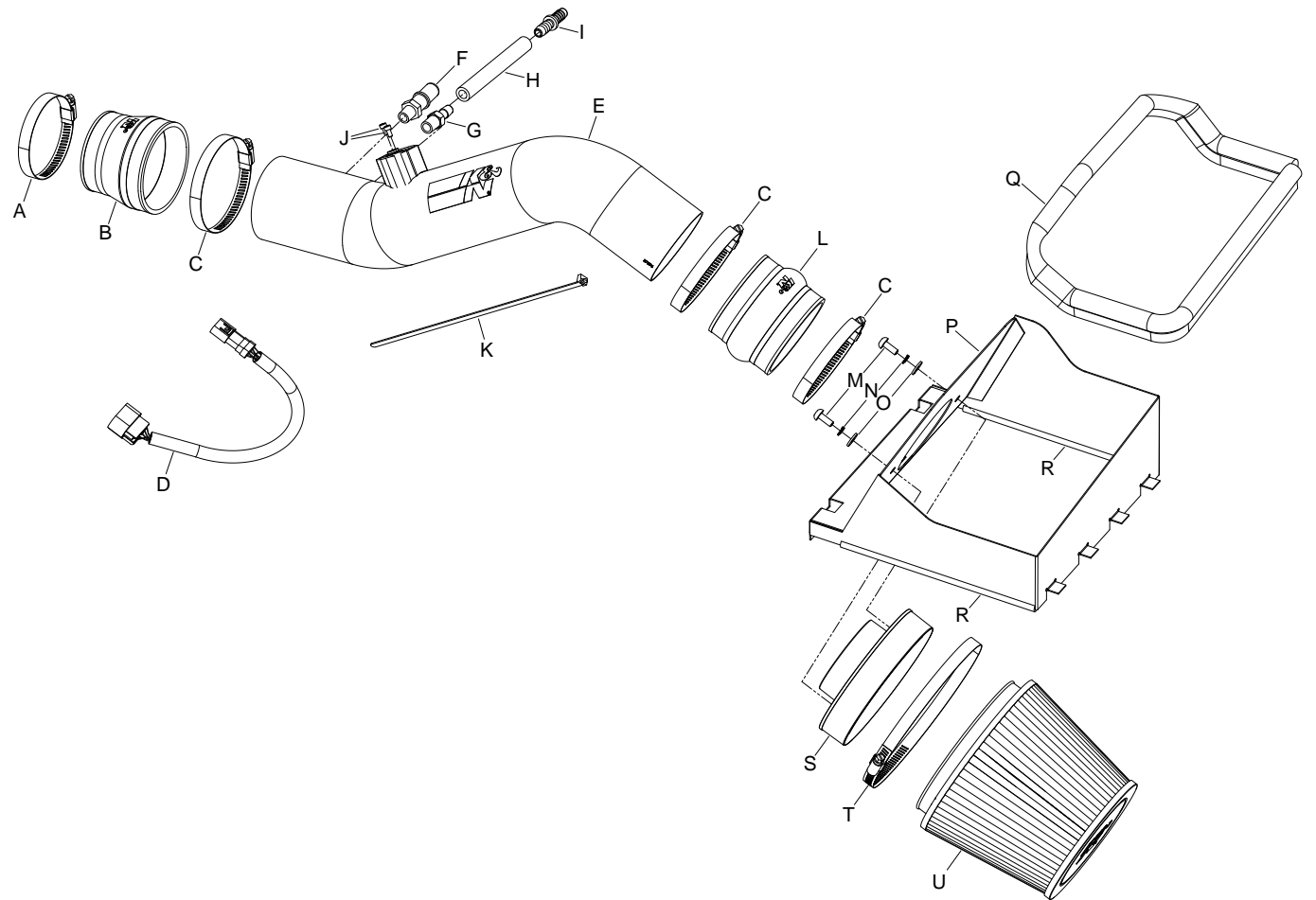

PARTS LIST:

Description	Qty.	Part #	Description	Qty.	Part #	Description	Qty.	Part #
A Hose Clamp #48	1	08601	H Hose; 3/8" ID X 5"L	1	08717	O Washer; 1/4"ID X 5/8"OD-SAE	2	08275
B Hose; 3-1/2" To 3"ID X 3"L TPRD	1	08724	I Vent; STRT 3/8" Hose-3/8"Hose	1	08041	P Heat Shield	1	074076
C Hose Clamp #56	3	08620	J Bolt; M4-0.07 8MM, A/H Cap, SS	2	07733	Q Edge Trim (35")	1	102471
D MAF Extension Harness, Ford	1	21780	K Cable Ties; 11" Black	1	21590	R Edge Trim (19")	1	102451
E Intake Tube	1	27596KS	L Hose; 3-1/2" ID X 3"L Hump	1	084057	S Adapter; Universal, 6" Filter 3.5	1	21512-1
F Vent; 1/4 NPT To Quik	1	082628	M Bolt; M6 X 1.00 X 16MM, SS	2	07730	T Hose Clamp #104	1	08697
G Vent; STRT, 3/8" Hose, 1/4"NPT,	1	08047	N Washer, M6 Spli Lock, Zinc	2	1-3025	U Air Filter	1	RC-5173

NOTE: FAILURE TO FOLLOW INSTALLATION INSTRUCTIONS AND NOT USING THE PROVIDED HARDWARE MAY DAMAGE THE INTAKE TUBE, THROTTLE BODY AND ENGINE.

TO START:

1. Turn off the ignition and disconnect the negative battery cable.

NOTE: Disconnecting the negative battery cable erases pre-programmed electronic memories. Write down all memory settings before disconnecting the negative battery cable. Some radios will require an anti-theft code to be entered after the battery is reconnected. The anti-theft code is typically supplied with your owner's manual. In the event your vehicles' anti-theft code cannot be recovered, contact an authorized dealership to obtain your vehicles anti-theft code.



2. Disconnect the mass air sensor electrical connection.

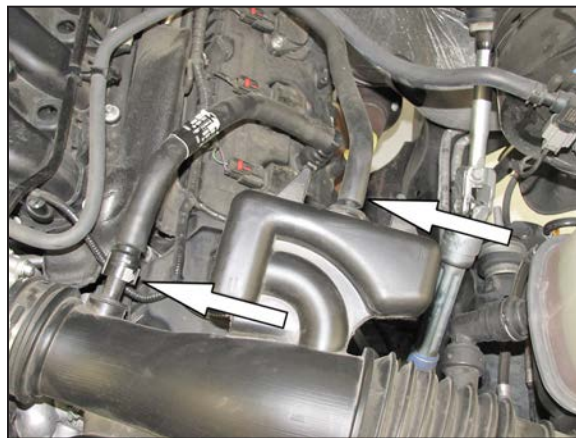

3. Disconnect the crank case vent hose and the EVAP vent hose from the stock intake tube.



4. Loosen the hose clamp securing the stock intake tube the throttle body.



5. Release the three clips securing the upper air box housing to the lower air box housing. Then remove the stock intake tube/upper air box housing and air filter from the vehicle.

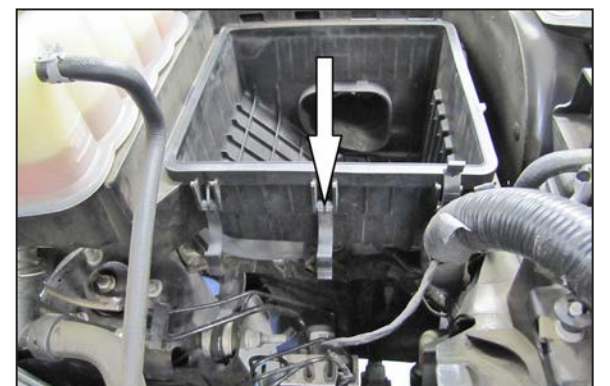

6. Remove the center upper air box retaining clip from the lower air box housing.
NOTE: K&N Engineering, Inc., recommends that customers do not discard factory air intake.



7. Install the provided silicone hose (08724) onto the throttle body and secure with the provided hose clamp.



8. Install the provided edge trim onto the heat shield as shown.
NOTE: Some trimming of the edge trim will be necessary.



9. Install the provided filter adapter into the heat shield and secure with the provided hardware.

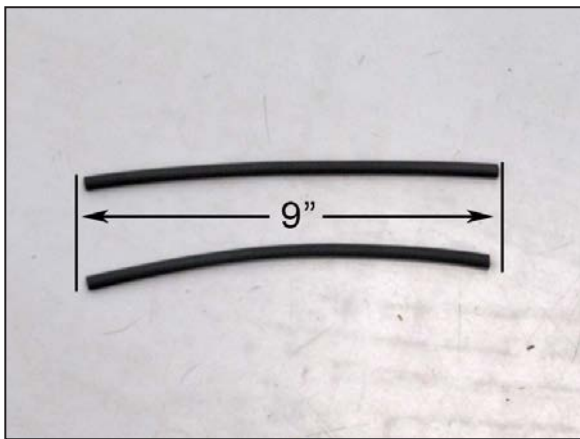

10. Cut the provided small edge trim into two sections that are 9" long.

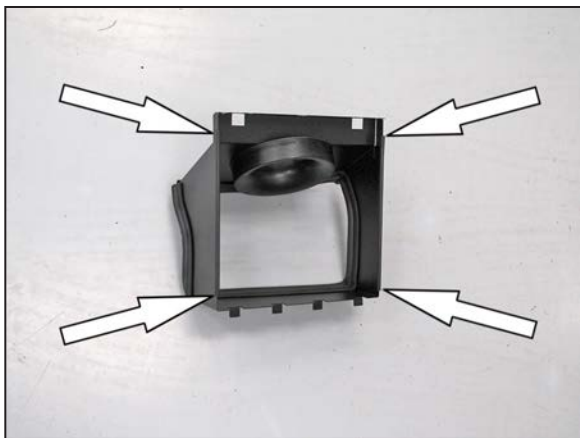

11. Install the small edge trim onto the bottom of the heat shield as shown.



12. Install the K&N® air filter onto the filter adapter and secure with the provided hose clamp.



13. Install the heat shield/filter assembly onto the lower air box and secure with the two remaining factory clips.



14. Install the provided hump hose (084057) onto the filter adapter and secure with the provided hose clamp.

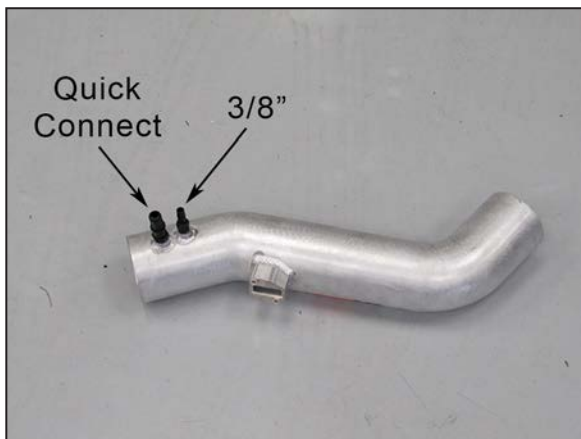

15. Install the Quick connect and 3/8" vent fitting into the K&N® intake tube as shown.



16. Remove the mass air sensor from the stock upper air box housing.



17. Install the mass air sensor into the K&N® intake tube and secure with the hardware provided.



18. Install the K&N® intake tube into the silicone hose at the throttle body and then into hump hose at the filter adapter. Then secure with the provided hose clamps.

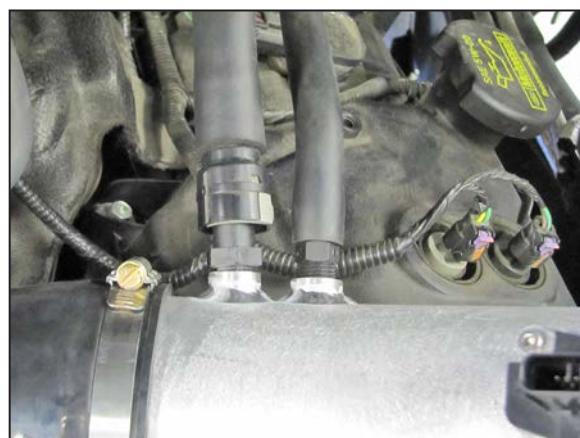

19. Connect the EVAP vent line and crank case vent lines to the fittings installed into the K&N® intake tube.



20. Connect the provided mass air extension harness into the factory wiring harness and then connect the other end onto the mass air sensor.



21. Secure the mass air wiring to the factory wiring harness with the provided tie wrap.



22. Reconnect the vehicle's negative battery cable. Double check to make sure everything is tight and properly positioned before starting the vehicle.

23. The C.A.R.B. exemption sticker, (attached), must be visible under the hood so that an emissions inspector can see it when the vehicle is required to be tested for emissions. California requires testing every two years, other states may vary.

24. It will be necessary for all K&N® high flow intake systems to be checked periodically for realignment, clearance and tightening of all connections. Failure to follow the above instructions or proper maintenance may void warranty.

ROAD TESTING:

1. Start the engine with the transmission in neutral or park, and the parking brake engaged. Listen for air leaks or odd noises. For air leaks secure hoses and connections. For odd noises, find cause and repair before proceeding. This kit will function identically to the factory system except for being louder and much more responsive.

2. Test drive the vehicle. Listen for odd noises or rattles and fix as necessary.

3. If road test is fine, you can now enjoy the added power and performance from your kit.

4. K&N Engineering, Inc., requires cleaning the intake system's air filter element every 100,000 miles. When used in dusty or off-road environments, our filters will require cleaning more often. We recommend that you visually inspect your filter once every 25,000 miles to determine if the screen is still visible. When the screen is no longer visible some place on the filter element, it is time to clean it. To clean and re-oil, purchase our filter Recharger® service kit, part number 99-5050 or 99-5000 and follow the easy instructions.