



## INSTALLATION INSTRUCTIONS

**77-2576KTK**

**FORD**

**2013-14 Flex**

**2013-14 Taurus**

**V6-3.5L**

### TOOLS NEEDED:

Ratchet  
Extension  
8mm Socket  
4mm Allen Key  
Flat Blade Screw Driver

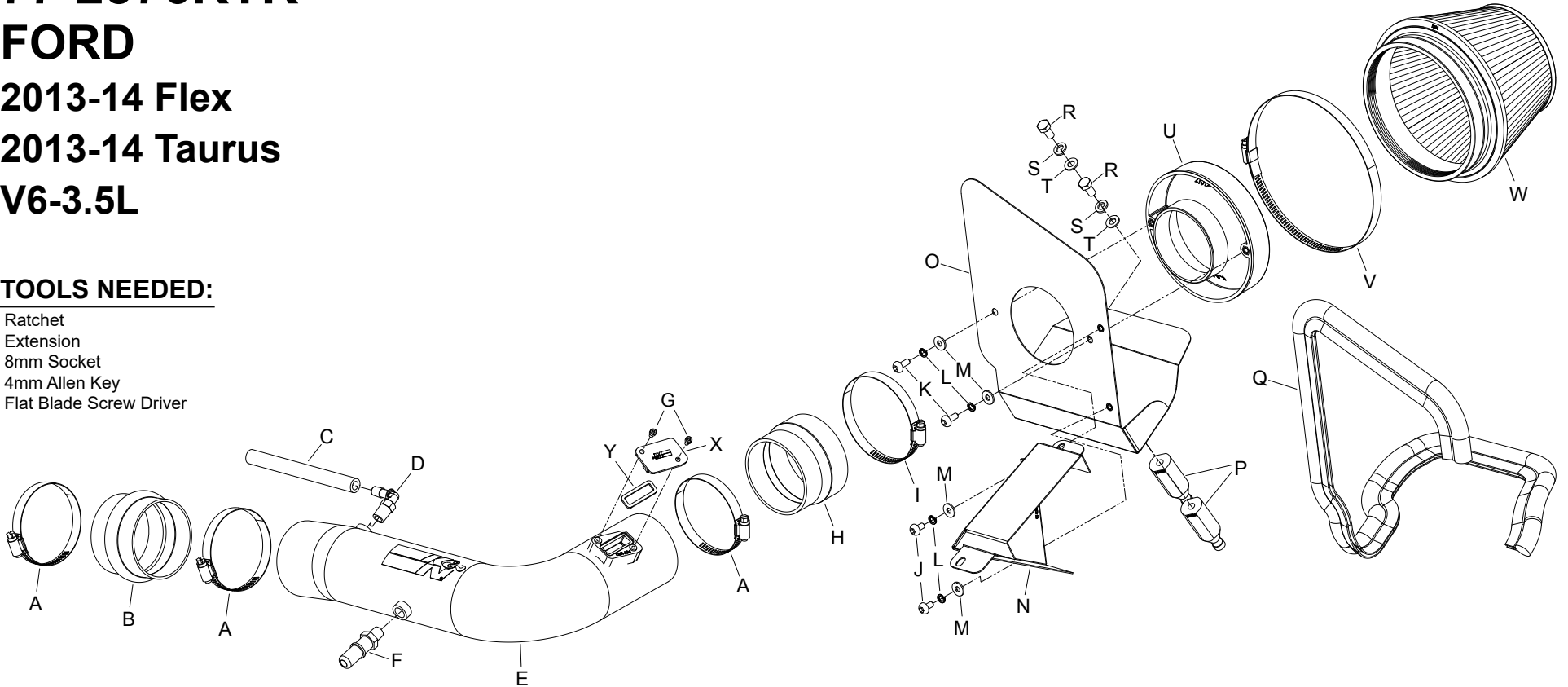

### PARTS LIST:

Description	Qty.	Part #	Description	Qty.	Part #	Description	Qty.	Part #
A Hose Clamp #48	3	08601	I Hose Clamp #56	1	08620	Q Edge Trim (39")	1	102496
B Hose; 3-1/4"ID X 2-5/8"L Hump	1	08171	J Bolt; M6 X 1.00 X 16MM	2	07730	R Bolt; 8MM-1.25 X 16MM	2	07844
C Hose; 3/8"ID X 6"L	1	5-1006	K Bolt; M6 X 1.00" 12MM	2	07794	S Washer; M8 Split Lock Zinc	2	1-3036
D Vent; 1/4"NPT, 90 DEG., 3/8"	1	08523	L Washer; M6 Split Lock Zinc	4	1-3025	T Washer; 8MM, Flat, SS	2	08272
E Intake Tube	1	27345	M Washer; 6MM, Flat, SS	4	08269	U Adapter; Universal, 6" Filter 3.5"	1	21512-1
F Vent; 1/4"NPT To Quick	1	082628	N Heat Shield; Scoop	1	074083	V Hose Clamp # 104	1	08697
G Bolt; M4-0.07 8MM, A/H Cap, SS	2	07733	O Heat Shield	1	074082	W Air Filter	1	RC-2960XD
H Hose; 3.5"ID To 3.25"ID X 2.5"L	1	08496	P Standoff; 6.0 Ford Airbox	2	06532	X Block Off	1	21508
						Y Gasket	1	09076

**NOTE: FAILURE TO FOLLOW INSTALLATION INSTRUCTIONS AND NOT USING THE PROVIDED HARDWARE MAY DAMAGE THE INTAKE TUBE, THROTTLE BODY AND ENGINE.**

### TO START:

1. Turn off the ignition and disconnect the negative battery cable.

**NOTE: Disconnecting the negative battery cable erases pre-programmed electronic memories. Write down all memory settings before disconnecting the negative battery cable. Some radios will require an anti-theft code to be entered after the battery is reconnected. The anti-theft code is typically supplied with your owner's manual. In the event your vehicles anti-theft code cannot be recovered, contact an authorized dealership to obtain your vehicles anti-theft code.**



2. Disconnect the mass air sensor electrical connection.

**NOTE: Some vehicles may not be equipped with a mas air sensor.**

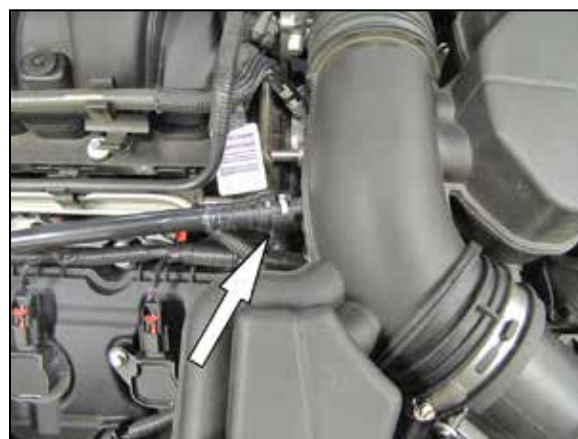

3. Disconnect the crank case vent tube from the factory intake tube.



4. Disconnect the EVAP vent line from the check valve as shown.



5. Loosen the two hose clamps which secure the factory intake tube to the throttle body and factory air box. Remove the factory intake tube from the vehicle.



6. Remove the plastic cover over the fresh air intake scoop.

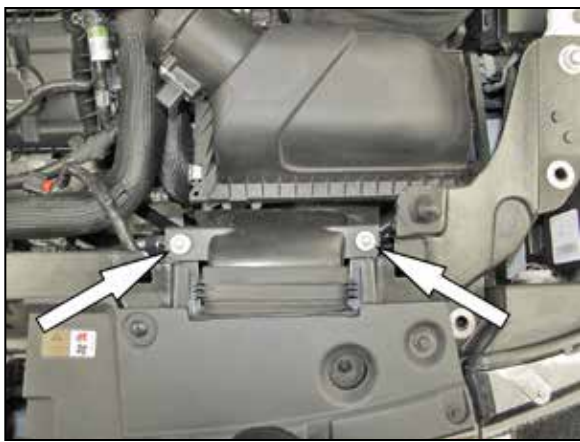

7. Remove the two bolts which secure the fresh air intake scoop.

**NOTE:** These bolts will be reused in a latter step.



8. Lift up the air box to dislodge it from the mounting grommets and then remove it from the vehicle.

**NOTE:** K&N Engineering, Inc., recommends that customers do not discard factory air intake.

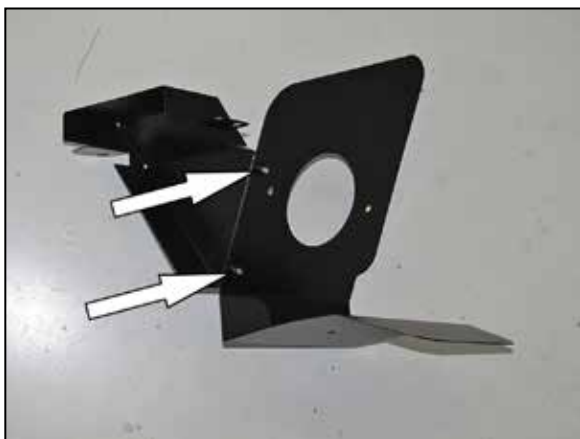

9. Install the provided fresh air scoop onto the K&N® heat shield and secure with the provided hardware.

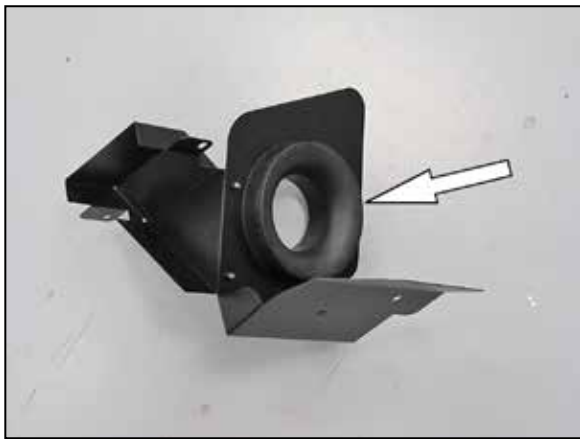

10. Install the filter adapter into the heat shield and secure with the provided hardware.

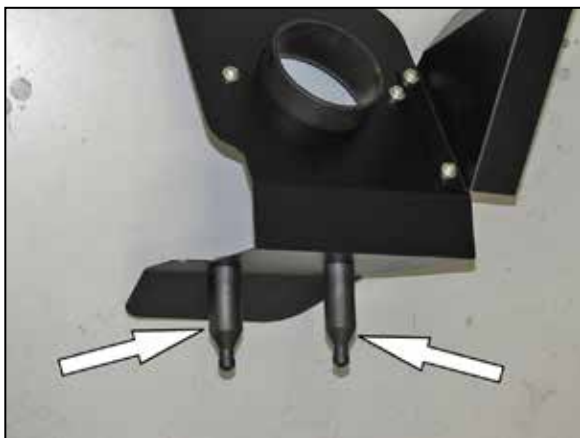

11. Install the two provided mounts onto the heat shield as shown using the provided hardware.

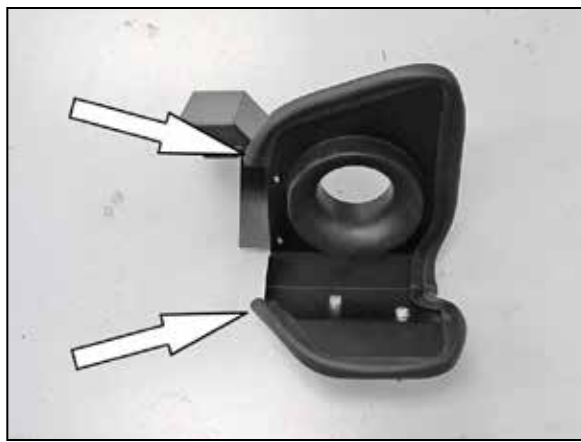

12. Install the provided edge trim onto the heat shield as shown.

**NOTE:** Some trimming of the edge trim will be necessary.



13. Install the K&N® air filter onto the filter adapter and secure with the provided hose clamp.



14. Install the heat shield assembly into the vehicle so that the mounting studs go into the air box mounting grommets.



15. Install the provided silicone hose (08496) onto the filter adapter and secure with the provided hose clamp.



16. Install the provided silicone hose (08171) onto the throttle body and secure with the provided hose clamp.

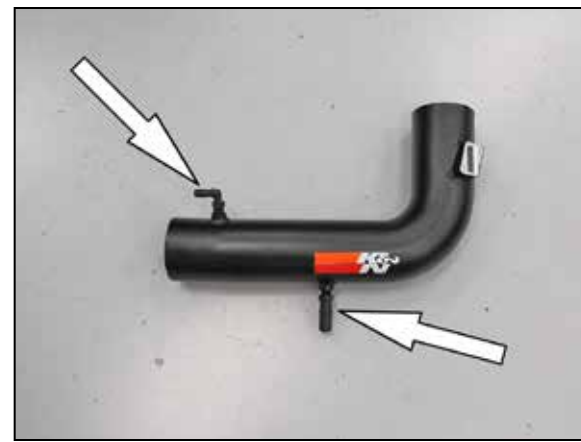

17. Install the provided 90° NPT vent fitting and NPT quick disconnect fitting into the K&N® intake tube as shown.

**NOTE:** Plastic NPT fittings are easy to cross thread. Install the vent fitting "hand" tight, then turn it two complete turns with a wrench.



18. Remove the two screws that secure the mass air sensor into the factory air box and then remove the sensor from the air box.



19. Install the mass air sensor into the K&N® intake tube and secure with the provided hardware.

**NOTE:** On vehicles that are not equipped with a mass air sensor, install the provided block off plate and gasket.



20. Install the K&N® intake tube assembly into the silicone hose at the throttle body and then at the filter adapter, align the tube and heat shield for best fit and then secure with the provided hose clamps.



21. Secure the K&N® fresh air intake scoop to the core support with the factory bolts removed in step #7. Reinstall the factory plastic cover.



22. Using the provided hose, connect the EVAP vent line to the 90° vent fitting installed into the K&N® intake tube.



23. Connect the factory crank case vent to the quick connect fitting installed into the K&N® intake tube as shown.



24. Connect the mass air sensor electrical connection.

**NOTE: On vehicles that are not equipped with a mass air air sensor, skip this step.**



25. Reconnect the vehicle's negative battery cable. Double check to make sure everything is tight and properly positioned before starting the vehicle.

26. The C.A.R.B. exemption sticker, (attached), must be visible under the hood so that an emissions inspector can see it when the vehicle is required to be tested for emissions. California requires testing every two years, other states may vary.

27. It will be necessary for all K&N® high flow intake systems to be checked periodically for realignment, clearance and tightening of all connections. Failure to follow the above instructions or proper maintenance may void warranty.

#### ROAD TESTING:

1. Start the engine with the transmission in neutral or park, and the parking brake engaged. Listen for air leaks or odd noises. For air leaks secure hoses and connections. For odd noises, find cause and repair before proceeding. This kit will function identically to the factory system except for being louder and much more responsive.

2. Test drive the vehicle. Listen for odd noises or rattles and fix as necessary.

3. If road test is fine, you can now enjoy the added power and performance from your kit.

4. K&N Engineering, Inc., requires cleaning the intake system's air filter element every 100,000 miles. When used in dusty or off-road environments, our filters will require cleaning more often. We recommend that you visually inspect your filter once every 25,000 miles to determine if the screen is still visible. When the screen is no longer visible some place on the filter element, it is time to clean it. To clean and re-oil, purchase our filter Recharger® service kit, part number 99-5050 or 99-5000 and follow the easy instructions.