



INSTALLATION INSTRUCTIONS

77-1558KP DODGE / MITSUBISHI 2007-08 Dakota / Raider V6-3.7L

NOTE: This kit was not designed to fit vehicles with a body lift.

TOOLS NEEDED:

- Flat Blade Screwdriver
- 1/2" Socket
- 10mm Socket
- 13mm Socket
- 10mm Wrench
- Extension
- Ratchet

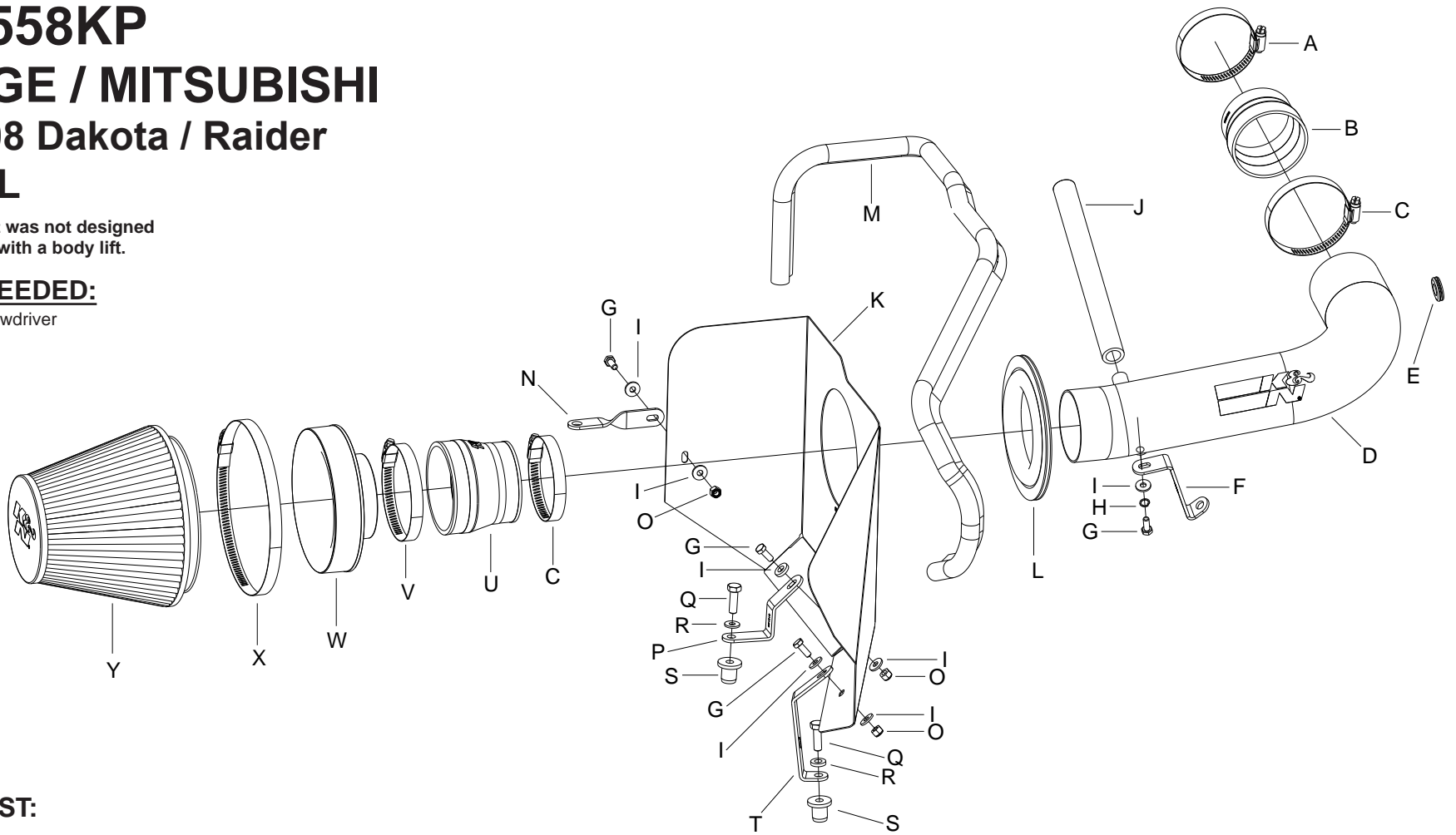

PARTS LIST:

Description	Qty.	Part #	Description	Qty.	Part #	Description	Qty.	Part #
A Hose Clamp #44	1	08560	J Hose; 5/8"ID X 9-3/4"L,	1	084047	S Insert; 5/16-18x.600ODx.730L	2	088002
B Hose; 2-3/4" TO 3" X 2"L	1	084036	K Heat Shield	1	07662	T Bracket; LG. "C" Mild STL.	1	010118
C Hose Clamp #48	2	08601	L Edge Trim	1	102469	U Hose; 3.5"ID TO 3"ID TPRD,	1	08724
D Intake Tube	1	27517	M Edge Trim	1	102486	V Hose Clamp #56	1	08620
E Grommet; 1"OD, 1/2"ID, 1/4"THK.	1	08167	N Bracket; Short Twist, FIN	1	070702	W Adaptor; #380	1	21512
F Bracket; "Z", STL, FB/PC	1	070096	O Nut; 6MM Nylock, Hexhead, SS	3	07512	X Hose Clamp #104	1	08697
G Bolt; 6MM-1.00 X 16MM, SS	4	07812	P Bracket; Mild STL. FB/PC	1	010120	Y Air Filter	1	RF-1048
H Washer; 1/4" Lock, ZN	1	08198	Q Bolt; 5/16"-18x1"L,SS	2	07777			
I Washer; 1/4"ID X 5/8"OD - SAE	7	08275	R Washer; 5/16"IDx5/8"OD, Flat	2	08276			

NOTE: FAILURE TO FOLLOW INSTALLATION INSTRUCTIONS AND NOT USING THE PROVIDED HARDWARE MAY DAMAGE THE INTAKE TUBE, THROTTLE BODY AND ENGINE.

TO START:

1. Turn off the ignition and disconnect the negative battery cable.

NOTE: Disconnecting the negative battery cable erases pre-programmed electronic memories. Write down all memory settings before disconnecting the negative battery cable. Some radios will require an anti-theft code to be entered after the battery is reconnected. The anti-theft code is typically supplied with your owner's manual. In the event your vehicles' anti-theft code cannot be recovered, contact an authorized dealership to obtain your vehicles anti-theft code.



2. Loosen the hose clamp at the throttle body and the airbox mounting nut. Then disconnect the crankcase vent from the inline fitting.



3. Disconnect the stock intake tube from the intake plenum. Then lift to remove to remove the airbox assembly from the vehicle as shown.



4. Depress the locking tab on the air temperature sensor electrical connection and disconnect the electrical connection.



5. Lift to dislodge the intake plenum from its mounting grommets and remove the intake plenum from the vehicle as shown.
NOTE: K&N Engineering, Inc., recommends that customers do not discard factory air intake.



6. Pull the two airbox mounting grommets shown from the inner fender.



7. Install the provided edge trim onto the heat shield as shown.
NOTE: Some trimming of the edge trim may be necessary.



8. Install the provided edge trim onto the heat shield as shown.

NOTE: Some trimming of the edge trim may be necessary.



9. Install the twist bracket (070702) onto the heat shield with the provided hardware as shown.



10. Install the "Z" bracket (010120) onto the heat shield with the provided hardware as shown.



11. Install the "C" bracket (010118) onto the heat shield with the provided hardware as shown.

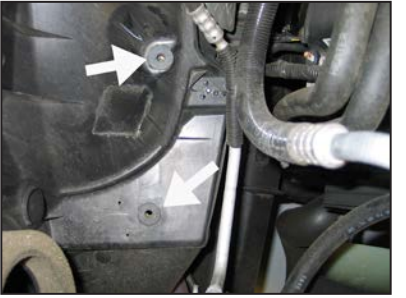

12. Install the two threaded inserts into the airbox mounting grommets location as shown.



13. Install the heat shield assembly and secure with the provided hardware and the factory mounting nut. Be sure to remove the factory spacer on the airbox mounting stud before installing the heat shield.

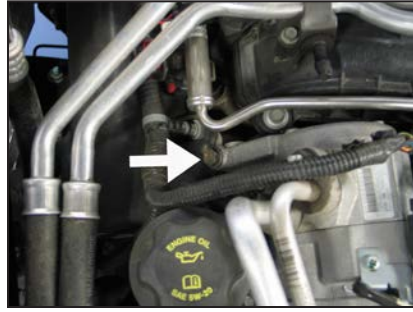

14. Remove the rear, lower A/C compressor mounting bolt shown.

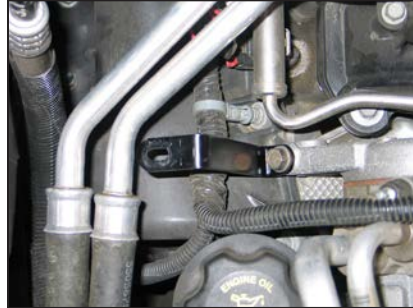

15. Install the tube mounting bracket onto the A/C compressor using the bolt removed in step #14 as shown.

NOTE: Due to vehicle manufacturing tolerances, check for proper clearance of the heater hoses at the tube mounting bracket assembly and adjust the heater hoses as necessary.



16. Install the provided silicone hose (084036) onto the throttle body and secure with the provided hose clamps.



17. Install the provided grommet into the K&N® intake tube as shown.



18. Twist the air temperature sensor counter clockwise and remove it from the stock intake plenum.

NOTE: Take care, as the air temperature sensor is very fragile.

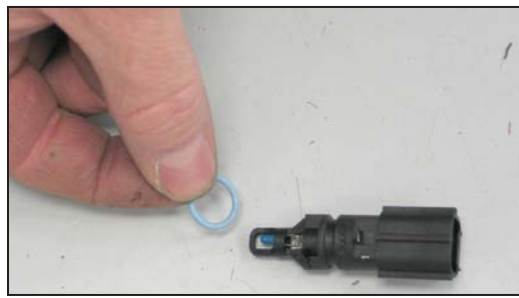

19. Remove the "O" ring from the air temperature sensor.

NOTE: Take care, as the air temperature sensor is very fragile.

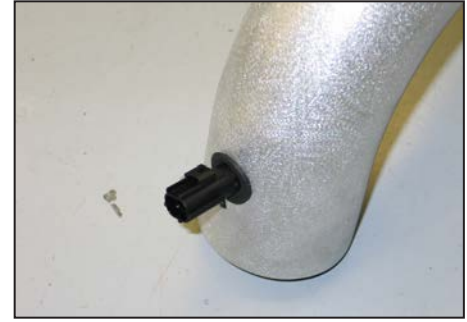

20. Install the air temperature sensor into the grommet installed into the K&N® intake tube in step #17.

NOTE: Take care installing the air temperature sensor as it is very fragile.



21. Install the K&N® intake tube into the silicone hose on the throttle body and position so the tube aligns with the mounting bracket. Secure the tube with the provided hose clamp and hardware.



22. Reconnect the air temperature sensor electrical connection.



23. Install the provided silicone hose onto the fitting on the K&N® intake tube and then attach the open end onto the hose to the factory crankcase tube.



24. Install the provided filter adapter into the K&N® air filter and secure with the provided hose clamp.

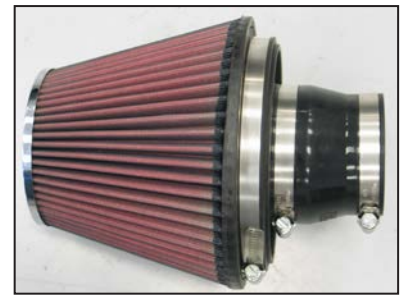

25. Install the silicone hose (08724) onto the air filter adapter as shown and secure with the provided hose clamp.



26. Install the air filter assembly onto the K&N® intake tube and secure with the provided hose clamp.



27. Reconnect the vehicle's negative battery cable. Double check to make sure everything is tight and properly positioned before starting the vehicle.

28. The C.A.R.B. exemption sticker, (attached), must be visible under the hood so that an emissions inspector can see it when the vehicle is required to be tested for emissions. California requires testing every two years, other states may vary.

29. It will be necessary for all K&N® high flow intake systems to be checked periodically for realignment, clearance and tightening of all connections. Failure to follow the above instructions or proper maintenance may void warranty.

ROAD TESTING:

1. Start the engine with the transmission in neutral or park, and the parking brake engaged. Listen for air leaks or odd noises. For air leaks secure hoses and connections. For odd noises, find cause and repair before proceeding. This kit will function identically to the factory system except for being louder and much more responsive.

2. Test drive the vehicle. Listen for odd noises or rattles and fix as necessary.

3. If road test is fine, you can now enjoy the added power and performance from your kit.

4. K&N Engineering, Inc., suggests checking the air filter element periodically for excessive dirt build-up. When the element becomes covered in dirt (or once a year), service it according to the instructions on the Recharger® service kit, part number 99-5050 or 99-5000.