

K&N TYPHOON INTAKE SYSTEMS

INSTALLATION INSTRUCTIONS

69-6028TTK

MAZDA

2009-13 6

L4-2.5L

TOOLS NEEDED:

Ratchet
Extension
13mm Socket
10mm Socket
8mm Socket
Flat Blade Screwdriver
Phillips Screwdriver
3/4" Wrench
10mm Wrench
3mm Allen

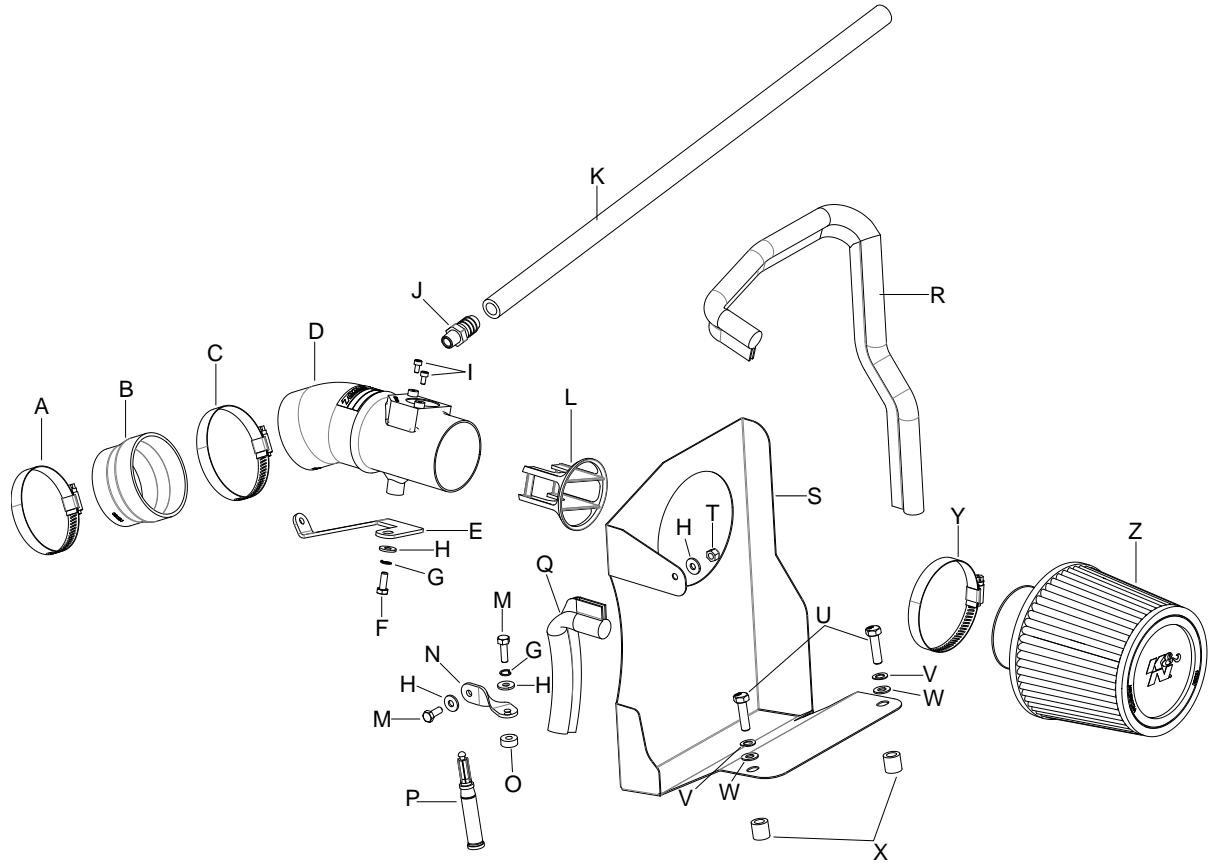

PARTS LIST:

| Description | Qty. | Part # | Description | Qty. | Part # | Description | Qty. | Part # |
|-------------------------------------|------|---------|---|------|---------|---|------|----------|
| A Hose Clamp #44 Stainless | 1 | 08560 | J Vent; Strt, 5/8 Barbed 1/4 NPT, Nylon | 1 | 08911-1 | S Heat Shield | 1 | 074078-1 |
| B Hose; 3" TO 2-3/4" ID X 2" L TPRD | 1 | 084036 | K Hose; 1/2"ID X 24"L | 1 | 08642 | T Nut; 6MM Nylock, Hexhead, SS | 1 | 07512 |
| C Hose Clamp #48 | 1 | 08601 | L Venturi, MAF Insert | 1 | 9-21070 | U Bolt; 8MM-1.25 X 30MM, Hexhead | 2 | 07821 |
| D Intake Tube | 1 | 27480TK | M Bolt; 6MM-1.00 X 16MM, SS | 2 | 07812 | V Washer; 8MM Spring (Wave) | 2 | 08239 |
| E Bracket;"L", STL, TB/PC | 1 | 083137 | N Bracket; Twist, FIN., TB/PC | 1 | 07105 | W Washer; 5/16"ID X 5/8"OD, Flat | 2 | 08276 |
| F Bolt; M6 X 1.00" X 20MM HEX, SS | 1 | 07795 | O Spacer: .625" OD X .250"ID X .250"L | 1 | 06555 | X Spacer; .625"OD X .375"ID X .625"L,ZN | 2 | 07849 |
| G Washer; 1/4" Lock, ZN | 2 | 08198 | P Super Glue | 1 | 409 | Y Hose Clamp #44 | 1 | 08577 |
| H Washer; 1/4"ID X 5/8"OD - SAE | 4 | 08275 | Q Edge Trim (9") | 1 | 102465 | Z Air Filter | 1 | RU-4960 |
| I Bolt; M4 - 0.07 8MM, A/H CAP, SS | 2 | 07733 | R Edge Trim (23") | 1 | 102495 | | | |

NOTE: FAILURE TO FOLLOW INSTALLATION INSTRUCTIONS AND NOT USING THE PROVIDED HARDWARE MAY DAMAGE THE INTAKE TUBE, THROTTLE BODY AND ENGINE.

TO START:

1. Turn off the ignition and disconnect the negative battery cable.

NOTE: Disconnecting the negative battery cable erases pre-programmed electronic memories. Write down all memory settings before disconnecting the negative battery cable. Some radios will require an anti-theft code to be entered after the battery is reconnected. The anti-theft code is typically supplied with your owner's manual. In the event your vehicles' anti-theft code cannot be recovered, contact an authorized dealership to obtain your vehicles anti-theft code.



2. Disconnect the mass air sensor electrical connection.



3. Release the green locking clip, then disconnect the crankcase vent line from the valve cover.

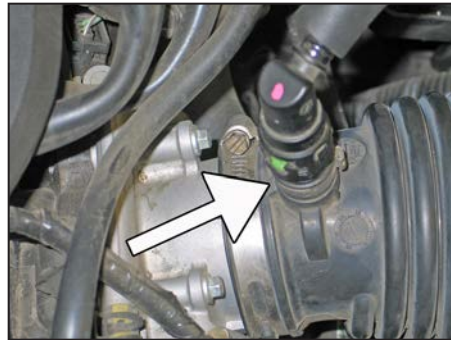

4. Loosen the hose clamp that secures the stock intake tube to the throttle body.

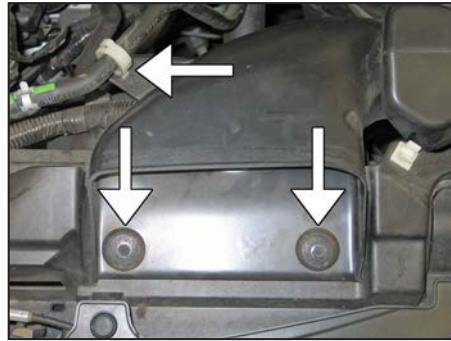

5. Remove the two bolts shown that secure the fresh air duct to the core support, then unhook the coolant hose from the clamp that secures it to the fresh air duct.

NOTE: These bolts will be reused.



6. Lift up to remove the airbox from the mounting grommets, then remove the complete airbox assembly from the vehicle.

NOTE: K&N Engineering, Inc., recommends that customers do not discard factory air intake.

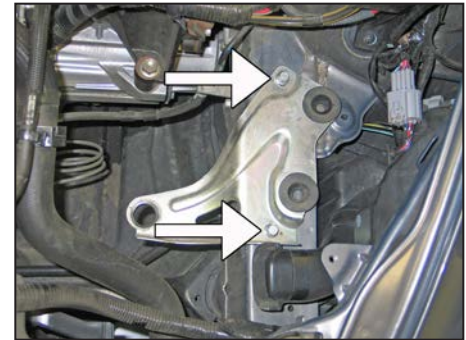

7. Remove the two bolts securing the airbox mounting plate to the inner fender. Remove the mounting plate from the vehicle.



8. Remove the two screws securing the mass air sensor to the factory airbox, then remove the mass air sensor from the airbox as shown.



9. Install the mass air sensor into the K&N® intake tube and secure with the provided hardware.



10. Install the 5/8" NPT fitting into the K&N® intake tube as shown.

NOTE: Plastic NPT fittings are easy to cross thread. Install the vent fitting "hand" tight, then turn it two complete turns with a wrench.



11. Apply a thin coat of the provided super glue to the lip of the air straightener and then install the straightener into the intake tube as shown.

NOTE: Be sure to position the straightener properly as shown.

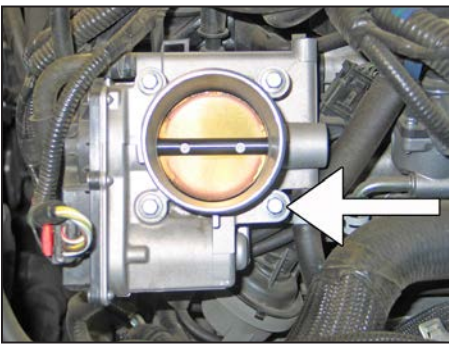

12. Remove the rear lower throttle body mounting bolt shown.

NOTE: This bolt will be reused in the next step.



13. Install the bolt removed in the previous step through the tube mounting bracket (083137). Install the bracket onto the throttle body as shown.

NOTE: Do not completely tighten at this time.



14. Install the provided silicone (084036) hose onto the throttle body and secure with the provided hose clamp.



15. Install the K&N® intake tube into the silicone hose on the throttle body and align with the mounting bracket. Secure the tube with the hose clamp and hardware provided.

NOTE: Do not completely tighten at this time.



16. Install the heat shield mounting bracket (07105) onto the heat shield using the provided hardware.

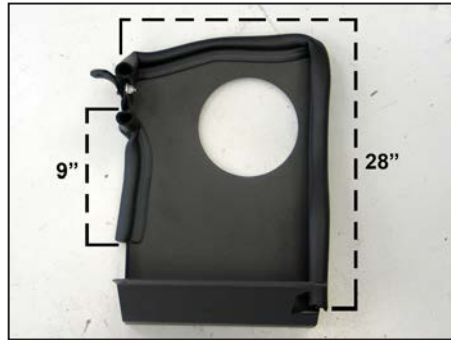

17. Install the two pieces of edge trim onto the heat shield as shown.

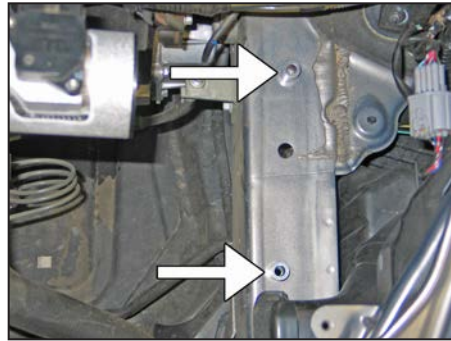

18. Set the two provided 1/2" spacers onto the inner fender over the airbox mounting bracket bolt holes.



19. Set the heat shield assembly into position on the inner fender and then secure to the inner fender with the provided hardware.



20. Secure the heat shield mounting bracket to the core support with the provided spacer and hardware.

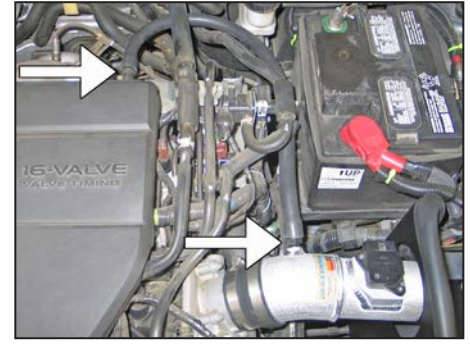

21. Install the provided crankcase vent hose onto the fitting installed into the K&N® intake tube. Attach the other end of the crankcase vent hose to the valve cover port.



22. Remove the fresh air intake scoop from the factory airbox.

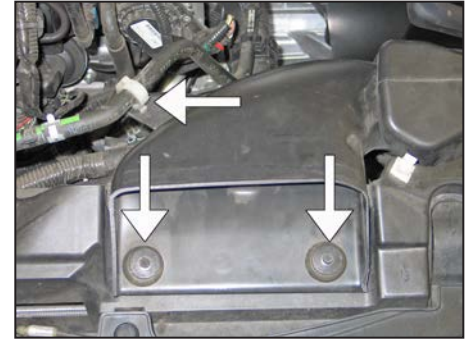

23. Feed the fresh air scoop's outlet into the heat shield while also attaching the inlet back onto the core support. Secure the scoop with the factory bolts that were removed in step #4 and attach the coolant hose with the factory clip.

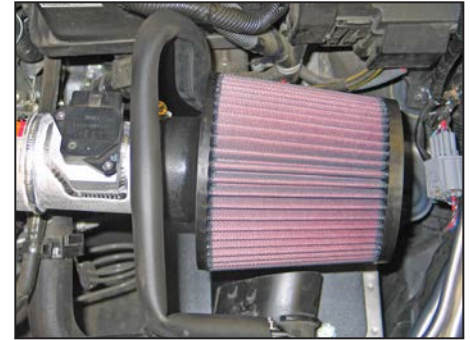

24. Install the K&N® air filter onto the intake tube and secure it in place with the provided hose clamp.

NOTE: Drycharger® air filter wrap; part # RX-4990DK is available to purchase separately.



25. Reconnect the mass air sensor electrical connection.



26. Reconnect the vehicle's negative battery cable. Double check to make sure everything is tight and properly positioned before starting the vehicle.

27. It will be necessary for all K&N® high flow intake systems to be checked periodically for realignment, clearance and tightening of all connections. Failure to follow the above instructions or proper maintenance may void warranty.

ROAD TESTING:

1. Start the engine with the transmission in neutral or park, and the parking brake engaged. Listen for air leaks or odd noises. For air leaks secure hoses and connections. For odd noises, find cause and repair before proceeding. This kit will function identically to the factory system except for being louder and much more responsive.

2. Test drive the vehicle. Listen for odd noises or rattles and fix as necessary.

3. If road test is fine, you can now enjoy the added power and performance from your kit.

4. K&N Engineering, Inc., requires cleaning the intake system's air filter element every 100,000 miles. When used in dusty or off-road environments, our filters will require cleaning more often. We recommend that you visually inspect your filter once every 25,000 miles to determine if the screen is still visible. When the screen is no longer visible some place on the filter element, it is time to clean it. To clean and re-oil, purchase our filter Recharger® service kit, part number 99-5050 or 99-5000 and follow the easy instructions.