



# TYPHOON INTAKE SYSTEMS

## INSTALLATION INSTRUCTIONS

**69-3512TP**  
**69-3512TR**  
**FORD**  
**2005-07 Focus**  
**L4-2.3L**

**NOTE:** Excluding 2005 LEV2 SULEV  
 Engine Test Group 5FMXV02.01GB

### TOOLS NEEDED:

Flat Blade Screwdriver  
 Ratchet  
 10mm socket  
 13mm end wrench  
 2.5mm Allen wrench  
 T20 Torx driver

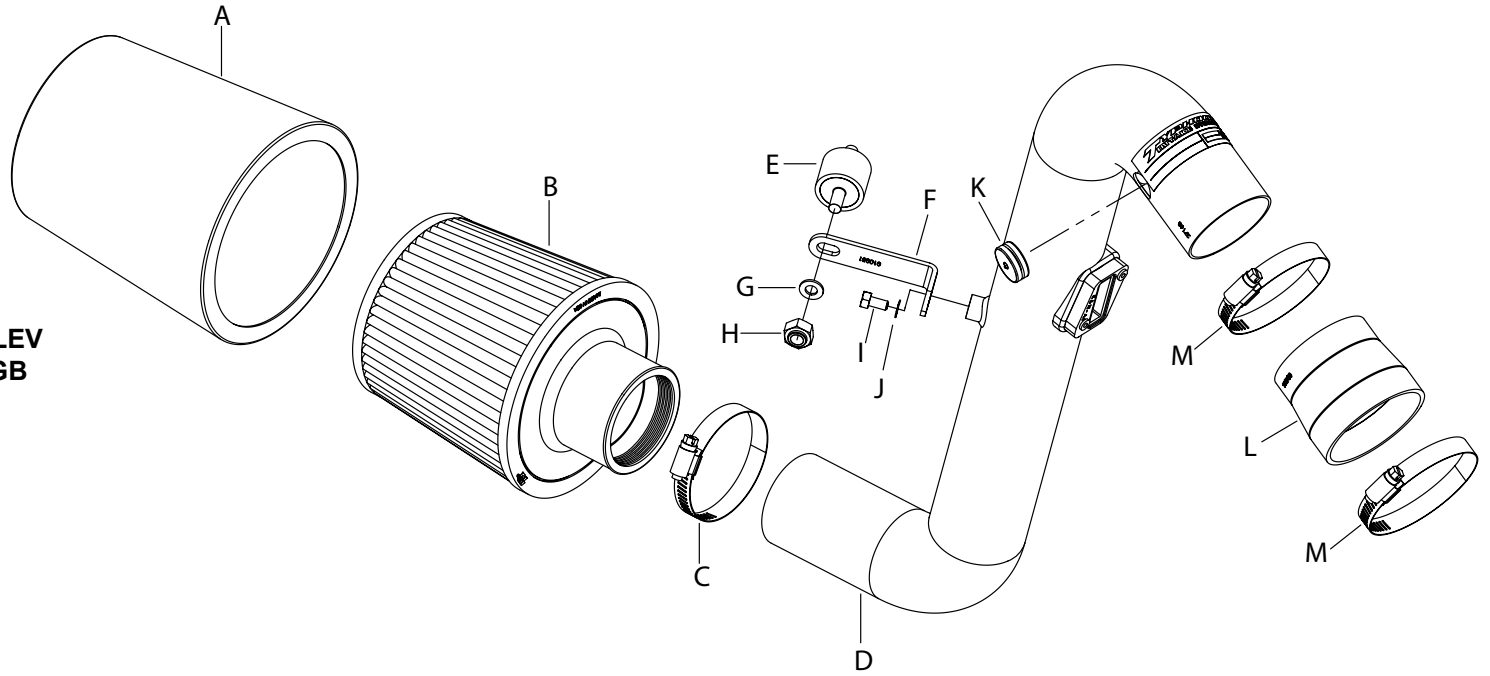

### PARTS LIST:

Description	Qty.	Part #	Description	Qty.	Part #	Description	Qty.	Part #
A Drycharger®, Black	1	Rx-4990DK	F Bracket; "L" Long, STL.	1	010051	K Grommet; Rubber	1	08053
B Air Filter	1	RU-4950	G Washer; 8mm Wave, SS	1	08272	L Hose; 2-1/2"ID To 2-3/4"OD X 2"L	1	084016
C Hose Clamp #40	1	08554	H Nut; 8mm Nylock, SS	1	07503	M Hose Clamp #44	2	08560
D Cold Air Intake Tube	1	27168	I Bolt; M6-1.00 X 12mm, SS	1	07727			
E Stud; Rubber Mount 8mm	1	070227	J Washer; 6mm Wave	1	08277			

**WARNING:** The K&N® Drycharger® included with this kit must be installed on the K&N® air filter when used with this K&N® cold air intake system. The K&N® cold air intake system a performance product that can be used safely during mild weather conditions. During harsh and inclement weather conditions, you must convert your cold air intake system to a short ram configuration, or return your vehicle to the stock OEM airbox and intake tract configuration. Failure to follow these instructions can void your warranty.

**NOTE: FAILURE TO FOLLOW INSTALLATION INSTRUCTIONS AND NOT USING THE PROVIDED HARDWARE MAY DAMAGE THE INTAKE TUBE, THROTTLE BODY AND ENGINE.**

### TO START:

1. Turn off the ignition and disconnect the negative battery cable.

**NOTE:** Disconnecting the negative battery cable erases pre-programmed electronic memories. Write down all memory settings before disconnecting the negative battery cable. Some radios will require an anti-theft code to be entered after the battery is reconnected. The anti-theft code is typically supplied with your owner's manual. In the event your vehicles' anti-theft code cannot be recovered, contact an authorized dealership to obtain your vehicles anti-theft code.



2. Depress the green locking tab on the crank case vent hose and then pull the vent hose to disconnect from the fitting as shown.

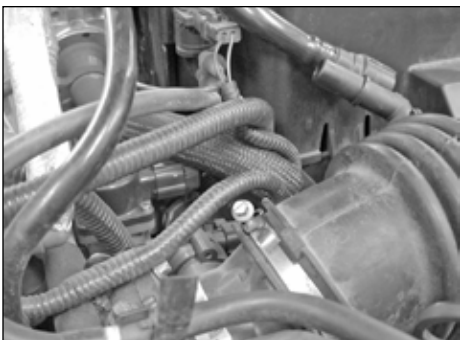

3. Loosen the hose clamp, which secures the factory intake tube to the throttle body.

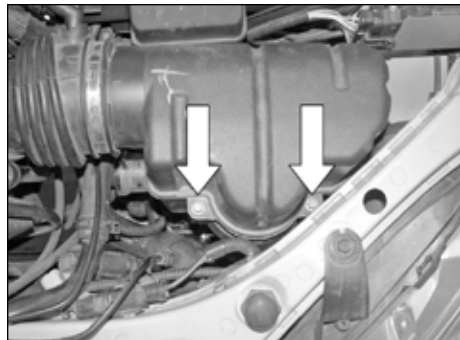

4. Loosen the two bolts, which secure the upper intake housing to the mass air sensor housing. **NOTE:** The two bolts do not separate from the upper intake housing.



5. Lift firmly to separate the upper intake housing from the mass air sensor housing and then remove the upper intake housing from the vehicle.

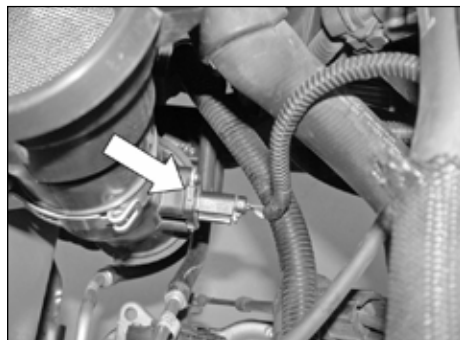

6. Depress the locking tab on the mass air sensor electrical connection and then disconnect the electrical connection.



7. Loosen the hose clamp, which secures the mass air sensor housing to the lower intake housing.



8. Remove the bolt, which secures the mass air sensor housing bracket to the inner fender.



9. Pull firmly up and remove the mass air sensor assembly from the vehicle.

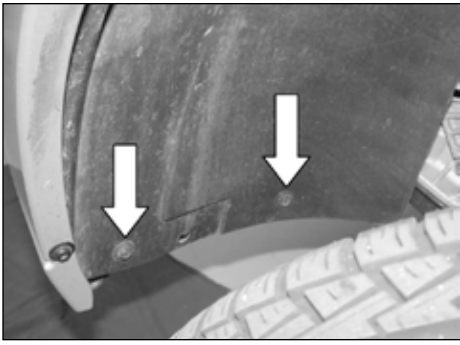

10. After jacking up the car and placing on suitable jack stands and chocking the rear wheels, remove the two bolts which secure the air box on equipped vehicle's or the one bolt on splash shield equipped vehicle's to the inner fender well.

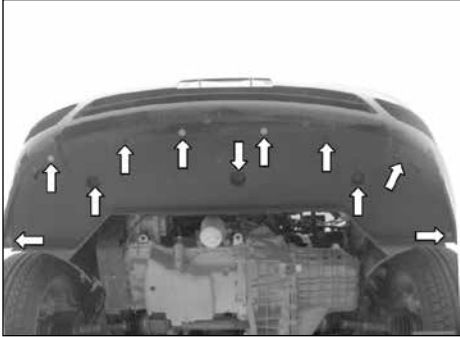

10a. On vehicle's equipped with the splash shield, remove the six bolts and five plastic screws which secure the splash shield to the bumper cover, then remove the splash shield from the vehicle.

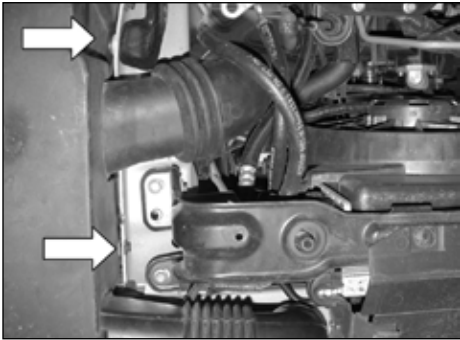

11. On vehicle's equipped with an air box cover, remove the two bolts which secure the cover to the frame rail, and the bolt which secures the intake snorkel to the radiator core support.



12. On vehicles equipped with an air box cover, lower the cover and remove it from the vehicle.

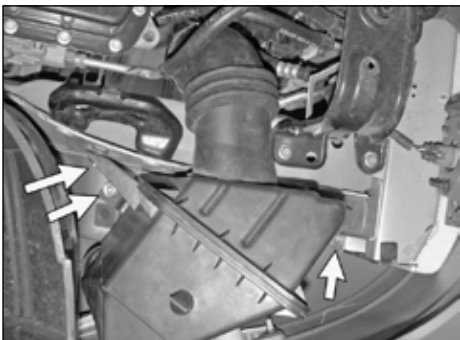

13. Remove the three bolts which secure the lower air box to the inner fender well.



14. Lower and remove the air box assembly from the vehicle.

**NOTE: On vehicles equipped with the intake snorkel on top of the air box behind the fender, it will be necessary to separate the snorkel from the air box during air box removal.**  
**NOTE: K&N Engineering, Inc., recommends that customers do not discard factory air intake.**



14a. On vehicle's equipped with the upper intake snorkel, pull down on the snorkel to dislodge it from the mount and then remove it from behind the fender.

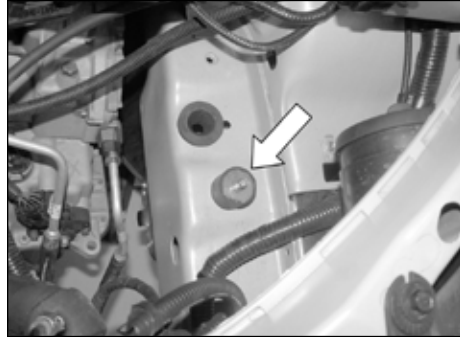

15. Install the supplied rubber mounted stud to the factory threaded hole as shown.

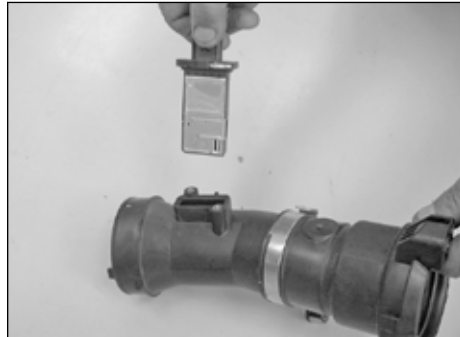

16. Remove the mass air sensor from the stock secondary tube.



17. Install the supplied "L" bracket and hardware to the K&N® intake kit. Do not tighten completely. **NOTE: Before installing the "L" bracket, inspect the inside of the tube for any debris, then clean the inside out with water and a towel. Inspect the tube one more time before proceeding to the next step.**



18. Install the supplied rubber grommet into the intake tube as shown.

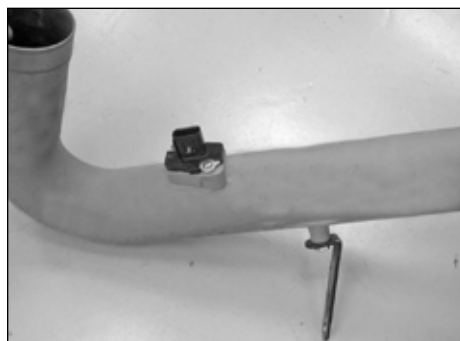

19. Using the stock bolts removed in step # 13, install the mass air sensor into the intake tube as shown.

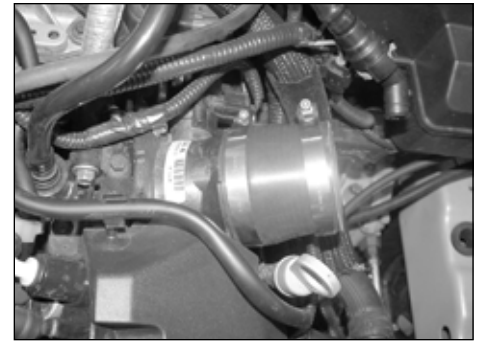

20. Install the supplied silicone hose and hose clamps onto the throttle body and tighten only the hose clamp over the throttle body.

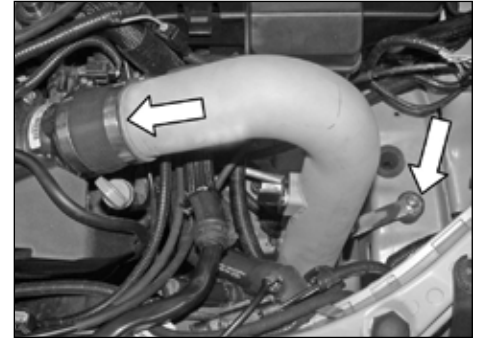

21. Install the intake tube into the vehicle by inserting one end onto the throttle body silicone hose then making sure that the "L" bracket lines up on the rubber mounted stud.

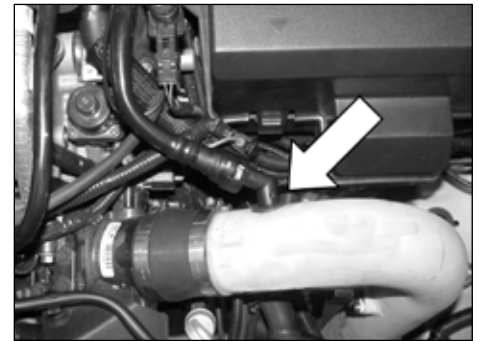

22. Insert the crankcase vent line into the rubber grommet on the intake tube as shown.

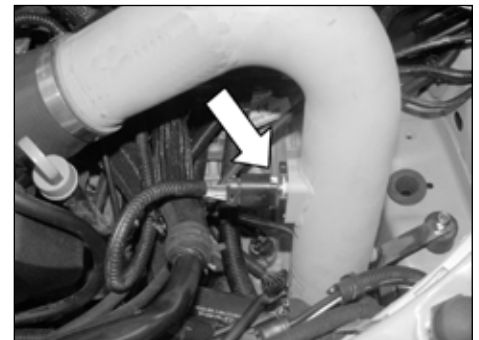

23. Re-connect the mass air sensor electrical connection as shown.



24. Install the K&N® Drycharger® onto the K&N® air filter as shown.

**NOTE: Please be aware the Drycharger® is water repellent, not water proof. Depending on conditions and usage the water repellent treatment is good for 1 to 2 years. See the parts list to reorder a new Drycharger® if necessary.**



25. From underneath the vehicle, install the K&N® air filter onto the intake tube and tighten hose clamp completely.



26. On vehicle's that were equipped with an air box cover, reinstall and secure with the bolts that were removed in step #11.



27. On vehicle's that were equipped with the splash shield, reinstall with the bolts removed in step #10a.



28. Reconnect the vehicle's negative battery cable. Double check to make sure everything is tight and properly positioned before starting the vehicle.

29. The C.A.R.B. exemption sticker, (attached), must be visible under the hood so that an emissions inspector can see it when the vehicle is required to be tested for emissions. California requires testing every two years, other states may vary.

30. It will be necessary for all K&N® high flow intake systems to be checked periodically for realignment, clearance and tightening of all connections. Failure to follow the above instructions or proper maintenance may void warranty.

#### ROAD TESTING:

1. Start the engine with the transmission in neutral or park, and the parking brake engaged. Listen for air leaks or odd noises. For air leaks secure hoses and connections. For odd noises, find cause and repair before proceeding. This kit will function identically to the factory system except for being louder and much more responsive.

2. Test drive the vehicle. Listen for odd noises or rattles and fix as necessary.

3. If road test is fine, you can now enjoy the added power and performance from your kit.

4. K&N Engineering, Inc., requires cleaning the intake system's air filter element every 100,000 miles. When used in dusty or off-road environments, our filters will require cleaning more often. We recommend that you visually inspect your filter once every 25,000 miles to determine if the screen is still visible. When the screen is no longer visible some place on the filter element, it is time to clean it. To clean and re-oil, purchase our filter Recharger® service kit, part number 99-5050 or 99-5000 and follow the easy instructions.