



# TYPHOON INTAKE SYSTEMS

## INSTALLATION INSTRUCTIONS

### 69-0017TS

### ACURA

### 2007-11 RDX

### L4-2.3L Turbo

#### TOOLS:

- Flat Blade Screwdriver
- Phillips Screwdriver
- Ratchet
- Extension
- 12mm Socket
- 10mm Socket
- 10mm Wrench
- 3mm Allen Wrench

#### PARTS LIST:

Description	Qty.	Part #	Description	Qty.	Part #	Description	Qty.	Part #
A Hose Clamp #44 SS	2	08560	G Washer; 1/4" Lock, ZN	2	08198	M Bracket; "L", STL FB/PC	1	070097
B Hose; 3"ID X 2"L, Black Sili.	1	08711	H Washer; 1/4"ID X 5/8"OD - SAE	6	08275	N Nut; 6mm Nylock, Hex., SS	2	07512
C Intake Tube	1	27441	I Bolt; M6-1.00 X 25MM, SS	1	07858	O Spacer: .625" OD X .250"ID X .250"L	1	06555
D Bolt; M4 - 0.07 8MM, A/H Cap	2	07733	J Heat Shield	1	07687	P Hose Clamp #48	1	08601
E Bracket; "L", STL FB/PC	1	070098	K Edge Trim	1	102469	Q Air Filter	1	RX-4730
F Bolt; 6MM-1.00 X 16MM, SS	3	07812	L Edge Trim	1	102489			

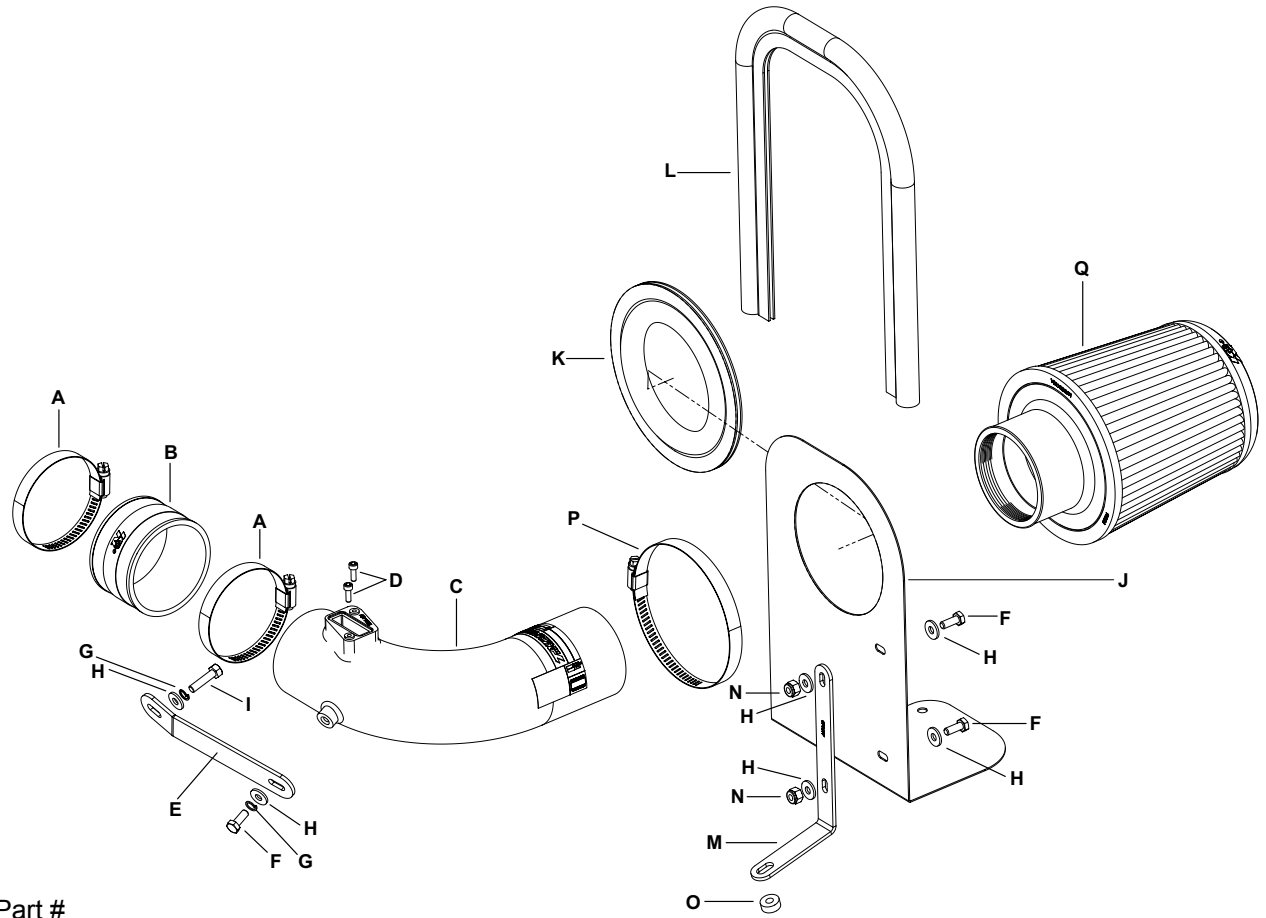

**NOTE: FAILURE TO FOLLOW INSTALLATION INSTRUCTIONS AND NOT USING THE PROVIDED HARDWARE MAY DAMAGE THE INTAKE TUBE, THROTTLE BODY AND ENGINE.**

#### TO START:

1. Turn off the ignition and disconnect the vehicles negative battery cable.  
**NOTE: Disconnecting the negative battery cable erases pre-programmed electronic memories. Write down all memory settings before disconnecting the negative battery cable. Some radios will require an anti-theft code to be entered after the battery is reconnected. The anti-theft code is typically supplied with your owner's manual. In the event your vehicles' anti-theft code cannot be recovered, contact an authorized dealership to obtain your vehicles anti-theft code.**



2. Loosen the four quarter turn fasteners that attach the engine cover and lift off the engine cover.



3. Disconnect the mass air sensor and unhook the wiring harness from the airbox and intake tube.

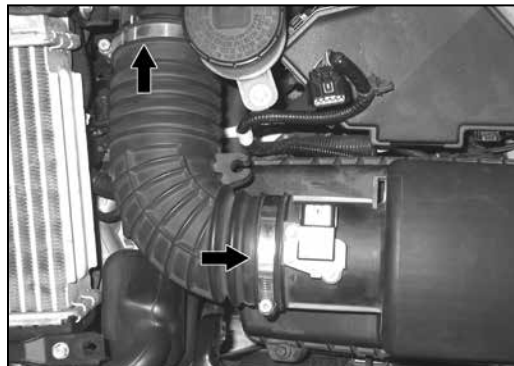

4. Loosen the two hose clamps that secure the intake tube to the airbox and turbo inlet tube.



5. Remove the stock intake tube from the vehicle.



6. Loosen the four bolts that secure the upper airbox housing to the lower airbox housing and then remove the upper airbox housing.



7. Remove the two lower airbox mounting bolts.

**NOTE: The inner lower mounting bolt is located near the base of the battery. One of the mounting bolts will be reused in a later step.**



8. Lift and remove the lower airbox assembly.

**NOTE: K&N Engineering, Inc., recommends that customers do not discard factory air intake.**

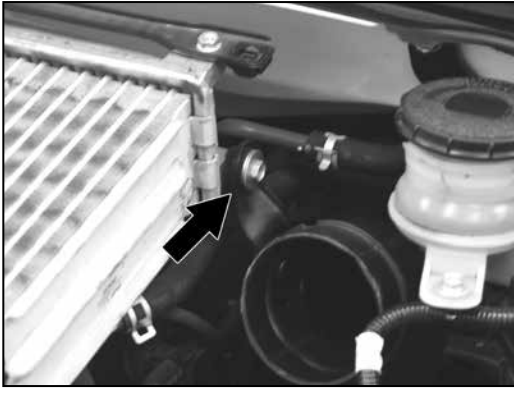

9. Remove the turbo inlet tube mounting bolt shown.

**NOTE: This bolt secures the turbo inlet tube to the intercooler.**

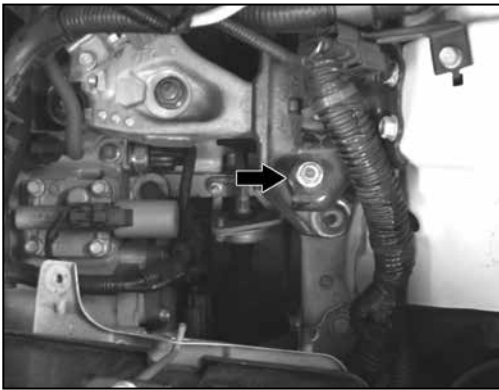

10. Remove the transmission mount bolt shown.

**NOTE: This bolt will be reused in a later step.**



11. Install supplied short edge trim into the hole of the heat shield as shown.

**NOTE: Some trimming of the edge trim may be necessary.**



12. Install the long edge trim around the outside of the heat shield as shown.

**NOTE: Some trimming of the edge trim may be necessary.**



13. Install the "L" bracket (070097) onto the heat shield with the provided hardware.

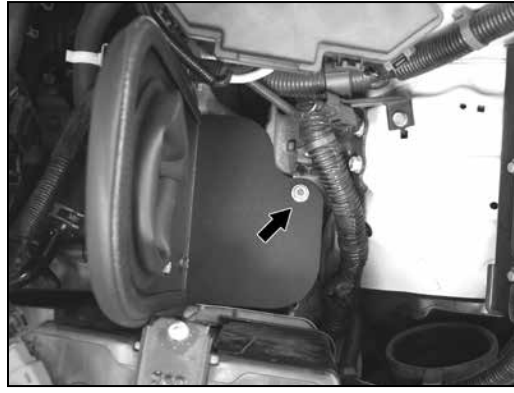

14. Install the heat shield assembly into the vehicle and secure to the engine mount using the bolt removed during step #10.

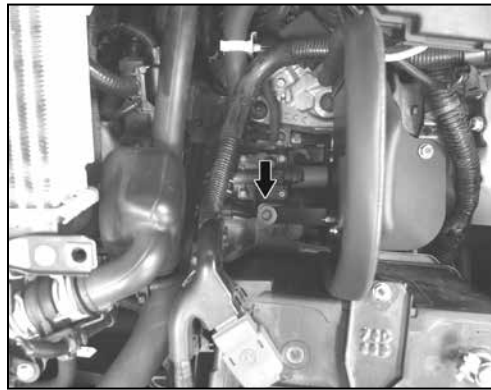

15. Secure the heat shield mounting bracket to the lower airbox mounting tab using the bolt removed in step #7.

**NOTE: Be sure to place the provided spacer between the bracket and mounting tab.**



16. Install the provided silicone hose (08711) onto the turbo inlet tube and secure with the provided hose clamp.



17. Install the supplied tube mounting bracket (070098) onto the K&N® intake tube using the provided hardware.

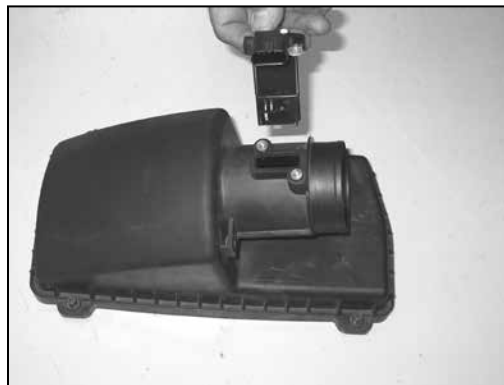

18. Remove the two mass air sensor retaining bolts and the remove the mass air sensor from the stock air filter housing.

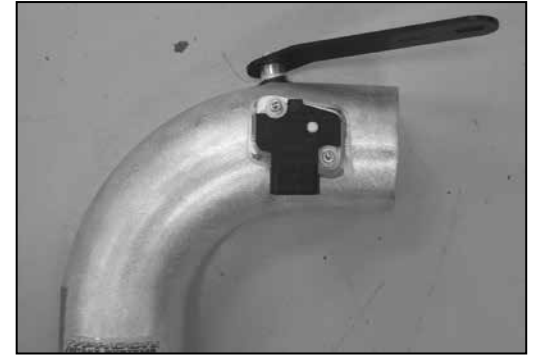

19. Install the mass air sensor into the K&N® intake tube and secure with the provided hardware.

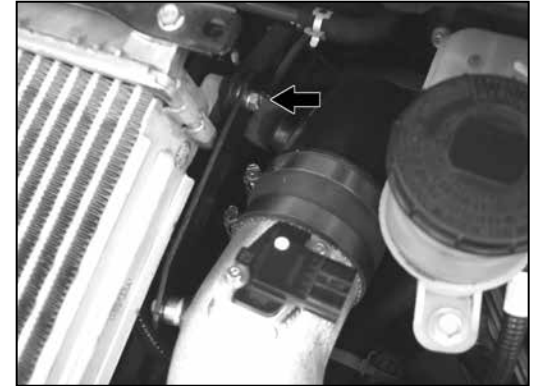

20. Install the K&N® intake tube into the silicone hose at the turbo inlet tube and align so the mounting bracket lines up with the turbo inlet mounting location. Secure the intake tube with the hose clamp and hardware provided.

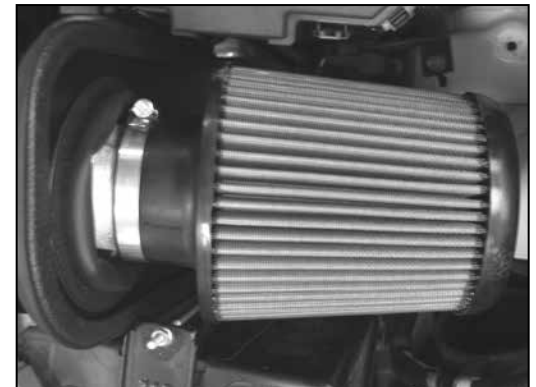

21. Install the K&N® air filter onto the intake tube and secure with the provided hose clamp.



22. Reconnect the mass air sensor electrical connection.



23. Reinstall the engine cover and secure with the factory quarter turn fasteners.



24. Reconnect the vehicle's negative battery cable. Double check to make sure everything is tight and properly positioned before starting the vehicle.

25. The C.A.R.B. exemption sticker, (attached), must be visible under the hood so that an emissions inspector can see it when the vehicle is required to be tested for emissions. California requires testing every two years, other states may vary.

26. It will be necessary for all K&N® high flow intake systems to be checked periodically for realignment, clearance and tightening of all connections. Failure to follow the above instructions or proper maintenance may void warranty.

**ROAD TESTING:**

1. Start the engine with the transmission in neutral or park, and the parking brake engaged. Listen for air leaks or odd noises. For air leaks secure hoses and connections. For odd noises, find cause and repair before proceeding. This kit will function identically to the factory system except for being louder and much more responsive.

2. Test drive the vehicle. Listen for odd noises or rattles and fix as necessary.

3. If road test is fine, you can now enjoy the added power and performance from your kit.

4. K&N Engineering, Inc., suggests checking the air filter element periodically for excessive dirt build-up. When the element becomes covered in dirt (or once a year), service it according to the instructions on the Recharger® service kit, part number 99-5050 or 99-5000