

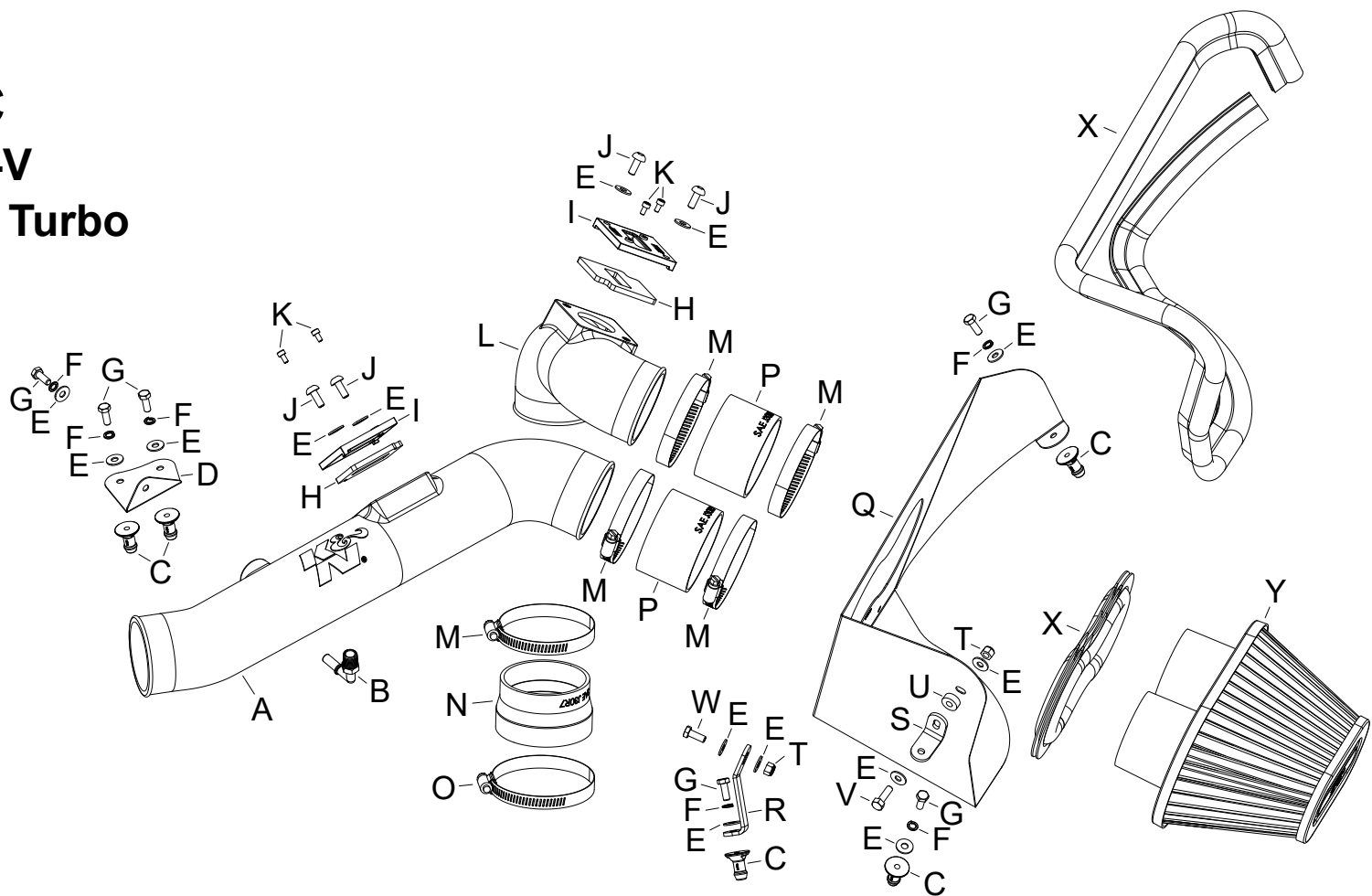

INTAKE SYSTEMS FOR VEHICLES LISTED ARE 50 STATE LEGAL. SEE KNFILTERS FOR CARB STATUS ON EACH PART FOR A SPECIFIC VEHICLE.

INSTALLATION INSTRUCTIONS

57-3093
CADILLAC
2016-17 ATS-V
V6-3.6L Twin Turbo



TOOLS NEEDED:

- ratchet
- extension
- 8mm socket
- 10mm socket
- 10mm wrench
- 15 torx
- 3mm allen
- 4mm allen
- flat blade screw driver

PARTS LIST:

Description	Qty.	Part #	Description	Qty.	Part #	Description	Qty.	Part #
A INTAKE TUBE (KY)	1	087323A	J BOLT; M6 X 1 X 16MM	4	07730	S BRACKET; "L", SML	1	070066A
B FITTING; .315"OD QUICK NPT	1	082631	K BOLT; M4 - .7 X 8MM	4	07733	T NUT; 6MM NYLOCK	2	07512
C MOUNT, PLASTIC AIRBOX	5	8-186-1	L INTAKE TUBE (KZ)	1	087324A	U SPACER: .625" OD X .250"ID	1	06555
D BRACKET; "L" MILD	1	064342	M HOSE CLAMP #48	5	08601	V BOLT; M6 X 1 X 20MM	1	07795
E WASHER; 6MM FLAT	14	08269	N HOSE; 3.25" TO 3" ID X 2" L	1	08186	W BOLT; M6-1 X 16MM	1	07812
F WASHER, M6 SPLIT LOCK ZINC	6	1-3025	O HOSE CLAMP #52	1	08610	X EDGE TRIM (75")	1	102460
G BOLT; M6 X 1 X 12MM	6	07727	P HOSE; 3" ID X 2" L REIN.	2	08711	Y FILTER CHARGER	1	RP-6101
H GASKET; 3/16 PORON	2	09069	Q HEAT SHIELD	1	073230			
I ADAPTOR; NYLON 6/6	2	21515-1	R BRACKET; "Z"	1	064341			

NOTE: FAILURE TO FOLLOW INSTALLATION INSTRUCTIONS AND NOT USING THE PROVIDED HARDWARE MAY DAMAGE THE INTAKE TUBE, THROTTLE BODY AND ENGINE.

TO START:

1. Turn off the ignition and disconnect the negative battery cable.
NOTE: Disconnecting the negative battery cable erases pre-programmed electronic memories. Write down all memory settings before disconnecting the negative battery cable. Some radios will require an anti-theft code to be entered after the battery is reconnected. The anti-theft code is typically supplied with your owner's manual. In the event your vehicles anti-theft code cannot be recovered, contact an authorized dealership to obtain your vehicles anti-theft code.



2. Disconnect the mass air sensor electrical connections.



3. Release the crank case vent hose quick disconnect fitting and then disconnect the crank case vent from the factory intake tube.



4. Loosen the hose clamp that secures the passenger side factory intake tube and then remove the intake tube from the vehicle.



5. Loosen the hose clamps that secure the driver's side factory intake tube and then remove the tube from the vehicle.



6. Lift the air filter housing assembly to dislodge it from the mounting grommets and then remove it from the vehicle.

NOTE: K&N Engineering, Inc., recommends that customers do not discard factory air intake.

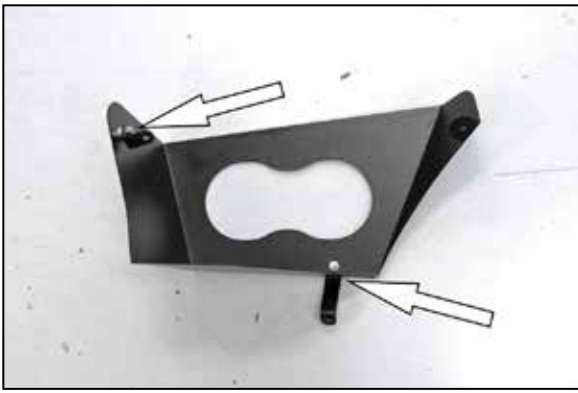

7. Install the provided heat shield mounting brackets onto the heat shield using the provided hardware.

NOTE: Be sure to place the provided spacer between the "L" bracket (070066) and the heat shield.

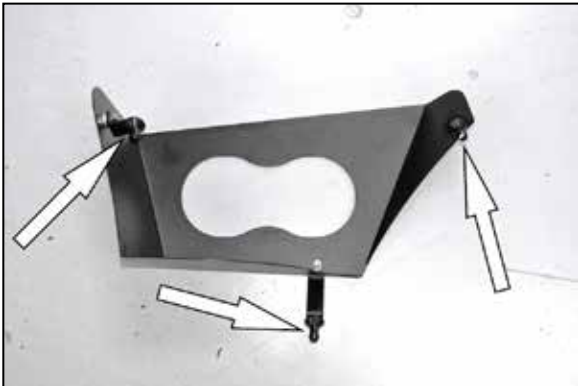

8. Install the provided mounting studs onto the heat shield and mounting brackets using the provided hardware.

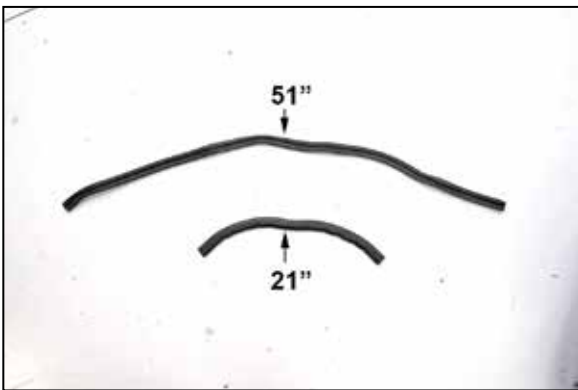

9. Cut the provided edge trim into two sections. One section should be 51" L and the other is 21" L.



10. Install the edge trim onto the heat shield as shown.



11. Install the K&N® air filter into the heat shield.



12. Install the heat shield assembly into the vehicle so that the mounting studs insert into the factory air filter housing mounting grommets.



13. Install the coupling hose (08186) onto the driver's side turbo inlet and install the two coupling hoses (08711) onto the air filter. Secure the couplers with the provided hose clamps.

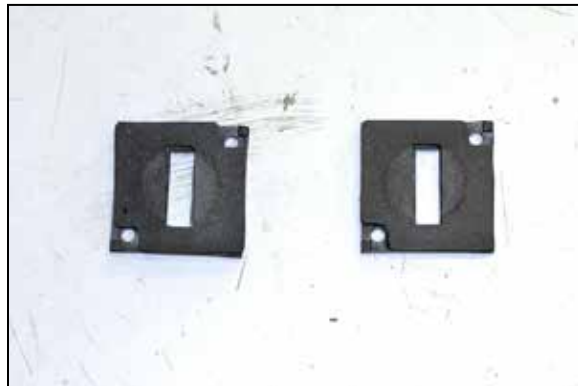

14. Install the two provided gaskets onto the K&N® mass air sensor adapters.



15. Remove the Drivers side mass air sensor from the factory air filter housing.



16. Install the driver's side mass air sensor into one of the K&N® adapters and secure with the provided hardware.

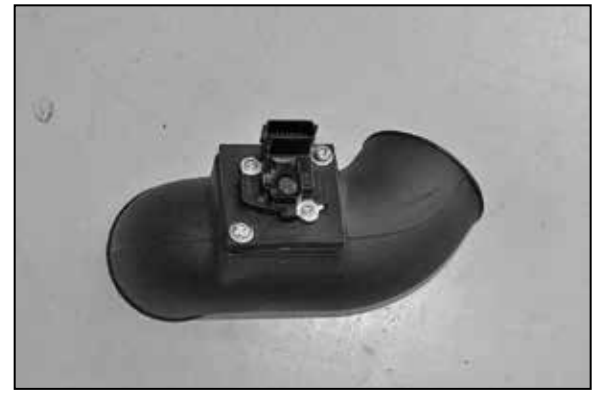

17. Install the driver's side sensor into the driver's side K&N® intake tube as shown.

NOTE: The opening in the sensor is to be towards the filter end of the intake tube.



18. Install the driver's side intake tube into the coupler at the turbo and then into the coupler on the filter. Secure the tube with the provided hose clamps.

NOTE: Do not completely tighten the hose clamps to allow adjustment once the passenger side tube is installed.



19. Remove the passenger side mass air sensor from the factory air filter housing.



20. Install the passenger side mass air sensor into one of the K&N® adapters and secure with the provided hardware.



21. Install the passenger side sensor into the driver's side K&N® intake tube as shown.

NOTE: The opening in the sensor is to be towards the filter end of the intake tube.

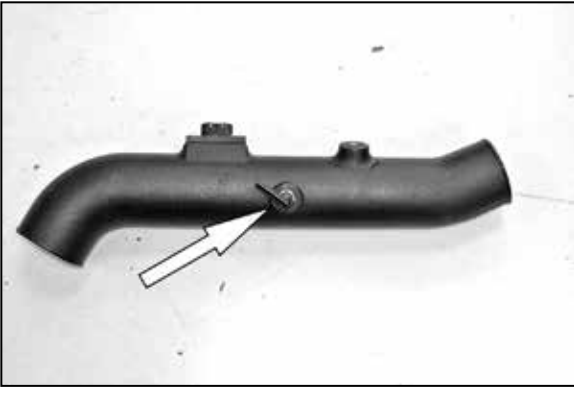

22. Install the provided quick disconnect fitting into the passenger side intake tube as shown.

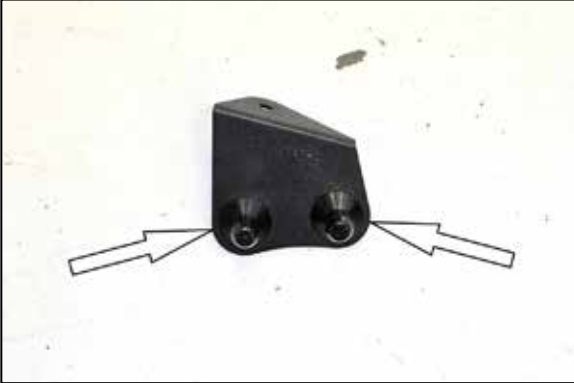

23. Install the two mounting studs onto the mounting bracket using the provided hardware.



24. Install the bracket assembly onto the K&N® intake tube as shown.



25. Install the passenger side intake tube into the coupler at the turbo inlet pipe and then into the coupler on the filter. Adjust the tubes and filter for best fit and then secure the tubes with the provided hose clamps.



26. Reconnect the mass air sensor electrical connections.



27. Connect the crank case vent hose to the quick disconnect fitting installed into the passenger side K&N® intake tube.



28. Reconnect the vehicle's negative battery cable. Double check to make sure everything is tight and properly positioned before starting the vehicle.

29. The C.A.R.B. exemption sticker, (attached), must be visible under the hood so that an emissions inspector can see it when the vehicle is required to be tested for emissions. California requires testing every two years, other states may vary.

30. It will be necessary for all K&N® high flow intake systems to be checked periodically for realignment, clearance and tightening of all connections. Failure to follow the above instructions or proper maintenance may void warranty.

ROAD TESTING:

1. Start the engine with the transmission in neutral or park, and the parking brake engaged. Listen for air leaks or odd noises. For air leaks secure hoses and connections. For odd noises, find cause and repair before proceeding. This kit will function identically to the factory system except for being louder and much more responsive.

2. Test drive the vehicle. Listen for odd noises or rattles and fix as necessary.

3. If road test is fine, you can now enjoy the added power and performance from your kit.

4. K&N Engineering, Inc., requires cleaning the intake system's air filter element every 100,000 miles. When used in dusty or off-road environments, our filters will require cleaning more often. We recommend that you visually inspect your filter once every 25,000 miles to determine if the screen is still visible. When the screen is no longer visible some place on the filter element, it is time to clean it. To clean and re-oil, purchase our filter Recharger® service kit, part number 99-5050 or 99-5000 and follow the easy instructions.

INTAKE SYSTEMS FOR VEHICLES LISTED ARE 50 STATE LEGAL. SEE KNFILTERS FOR CARB STATUS ON EACH PART FOR A SPECIFIC VEHICLE.