



## INSTALLATION INSTRUCTIONS

71-2545

DODGE / CHRYSLER

2012-15 Charger SRT 8

2011-15 Challenger SRT8

2012-15 300C SRT 8

V8-6.4L HEMI

### TOOLS NEEDED:

- 4mm Allen Wrench
- 10mm Socket
- 14mm Socket
- 10mm Wrench
- Extension
- Flat Blade Screwdriver
- Ratchet

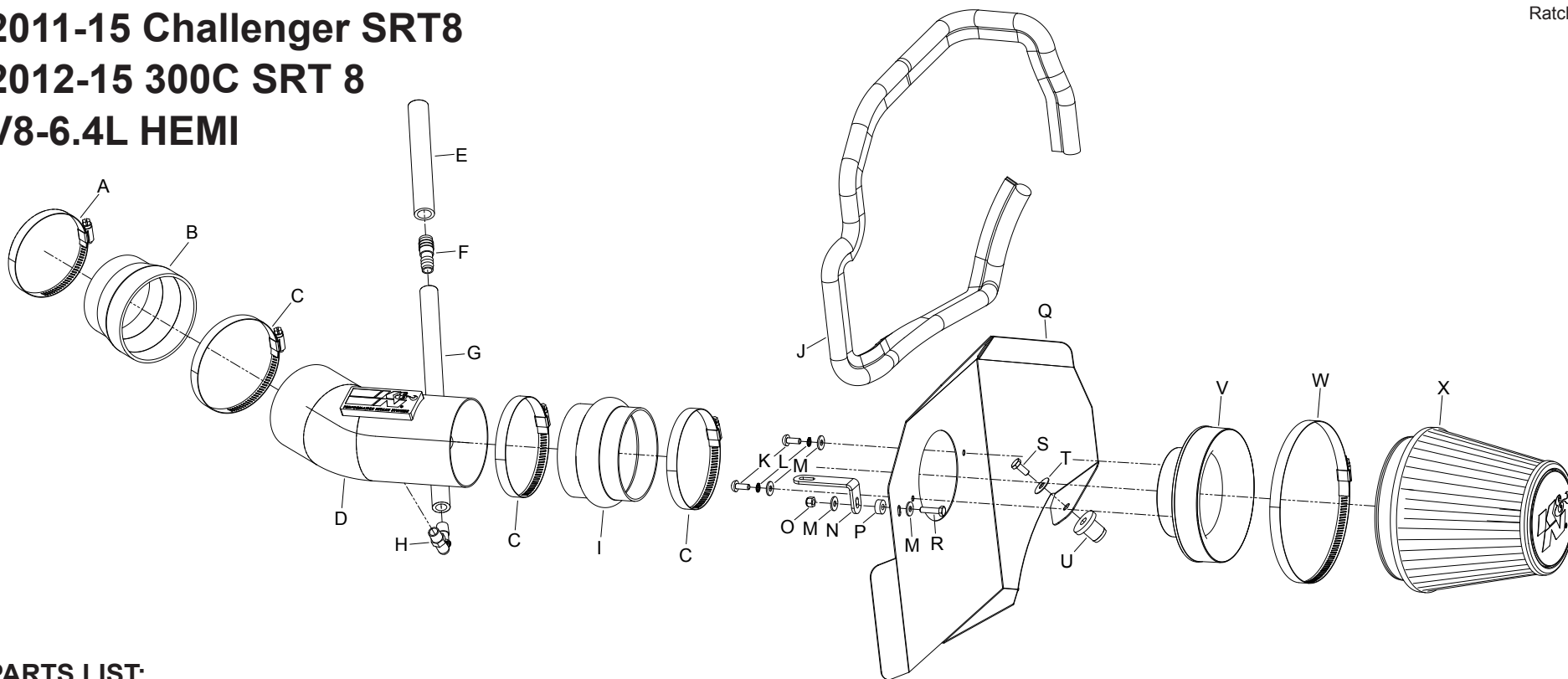

### PARTS LIST:

Description	Qty.	Part #	Description	Qty.	Part #	Description	Qty.	Part #
A Hose Clamp #56, Black Zinc	1	08620K	I Hose; 4"ID X 3"L Hump	1	08418	Q Heat Shield	1	074098
B Hose; 4"ID To 3.5" X 3"L TPRD	1	08497	J Edge Trim	1	102485	R Bolt; M6-1.00 X 25MM, SS	1	07858
C Hose Clamp #64, Black Zinc	3	08645K	K Bolt; M6 X 1.00 X 16MM, SS	2	07730	S Bolt; 3/8" -16 X 1-1/4"L SS Hex	1	07779
D Intake Tube	1	27592TK	L Washer; M6 Split Lock Zinc	2	1-3025	T Washer; 3/8" Flat Washer, SS	1	08134
E Hose; 5/8"ID X 6"L, Black	1	08653	M Washer; 6MM Flat, SS	4	08269	U Insert; 3/8-16 X 3/400 X 15/16L	1	08163
F Hose Mender; 1/2" To 5/8"	1	08726	N Bracket; 57-3017, "L", FIN.	1	070742	V Adaptor	1	27300
G Hose; 1/2" ID X 12"L	1	087031	O Nut; 6MM Nylock, Hexhead, SS	1	07512	W Hose Clamp #104	1	08697
H Vent; 90DEG, 1/2" Hose	1	08110FK	P Spacer; .625" OD X .250"ID	1	06555	X <a href="#">Air Filter</a>	1	RU-3102-HBK

**NOTE: FAILURE TO FOLLOW INSTALLATION INSTRUCTIONS AND NOT USING THE PROVIDED HARDWARE MAY DAMAGE THE INTAKE TUBE, THROTTLE BODY AND ENGINE.**

### TO START:

1. Turn off the ignition and disconnect the negative battery cable.  
**NOTE: Disconnecting the negative battery cable erases pre-programmed electronic memories. Write down all memory settings before disconnecting the negative battery cable. Some radios will require an anti-theft code to be entered after the battery is reconnected. The anti-theft code is typically supplied with your owner's manual. In the event your vehicles' anti-theft code cannot be recovered, contact an authorized dealership to obtain your vehicles anti-theft code.**



2. Disconnect the inlet air temperature air sensor electrical connection.



3. Lift up and remove the driver side ignition coil cover as shown.



4. Disconnect the crank case vent hose from the valve cover.

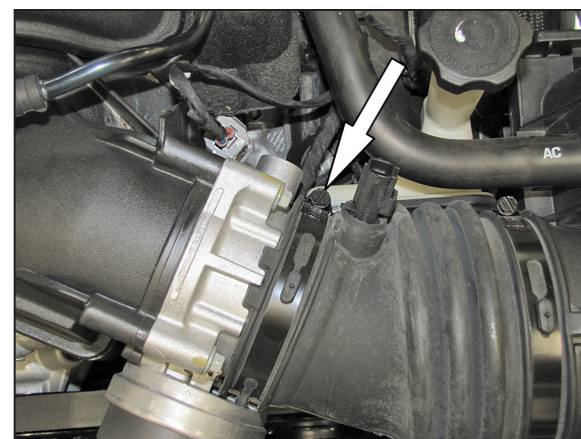

5. Loosen the hose clamp securing the intake tube to the throttle body.

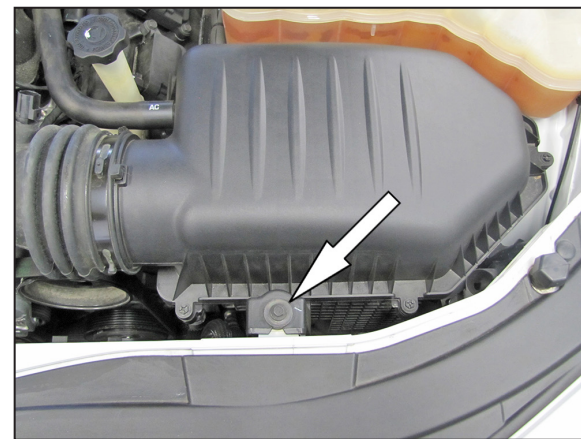

6. Remove the bolt which secures the air box to the core support.



7. Lift up and remove the complete intake track from the vehicle.

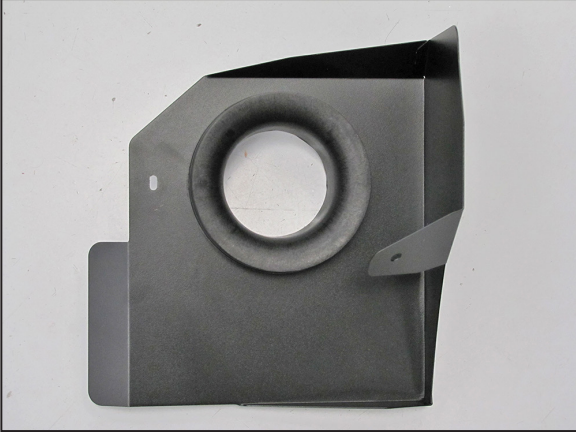

8. Install the filter adapter into the heat shield and secure with the provided hardware.

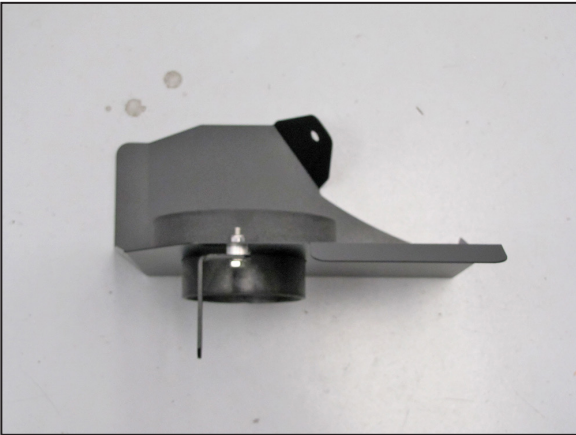

9. Install the provided heat shield mounting bracket (070742) along with the spacer onto the heat shield as shown.

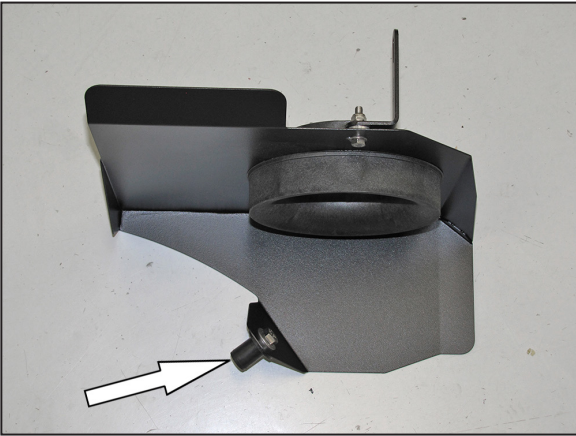

10. Install the provided inserted nut onto the heat shield as shown and secure with the provided hardware.



11. Install the provided edge trim onto the heat shield as shown.  
**NOTE: Some trimming of the edge trim will be necessary.**

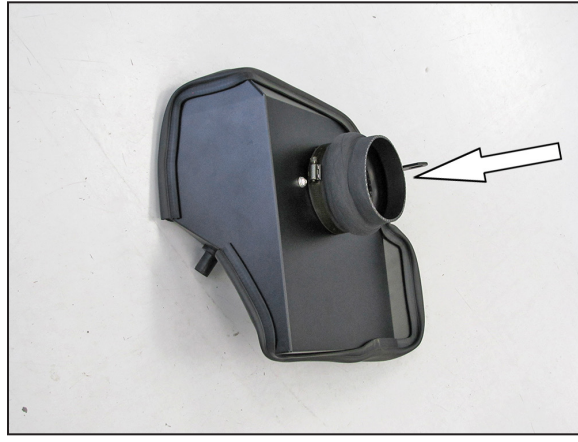

12. Install the provided silicone hump hose (08418) onto the filter adapter and secure with the provided hose clamp.

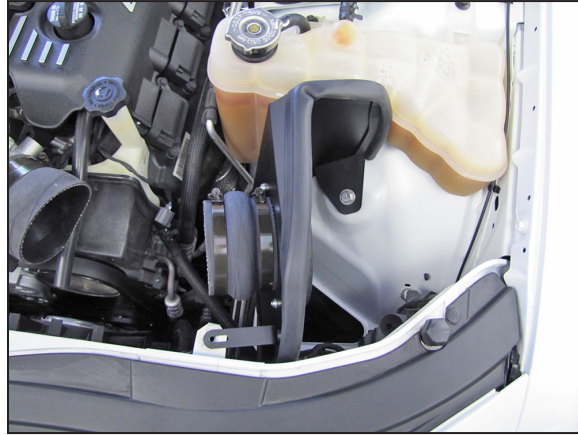

13. Set the heat shield assembly into position in the engine bay so the inserted nut passes into the air box mounting hole in the inner fender. Do not secure the heat shield at this time.



14. Install the silicone step hose (08050) onto the throttle body and secure with the provided hose clamp.

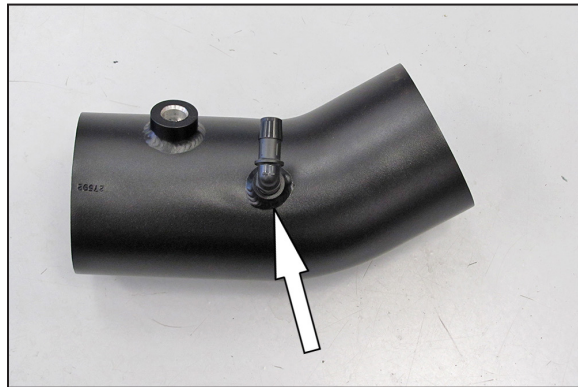

15. Install the provided 90° vent fitting into the K&N® intake tube as shown.

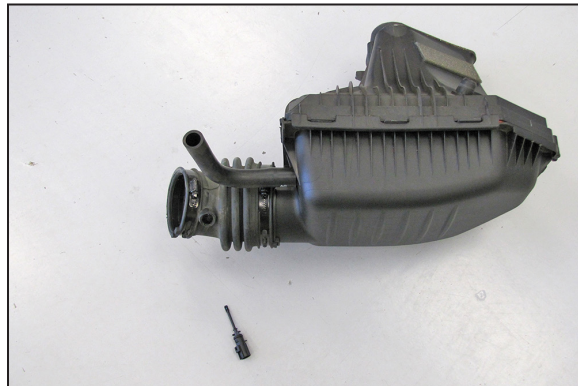

16. Remove the inlet air temperature sensor from the factory intake tube as shown.

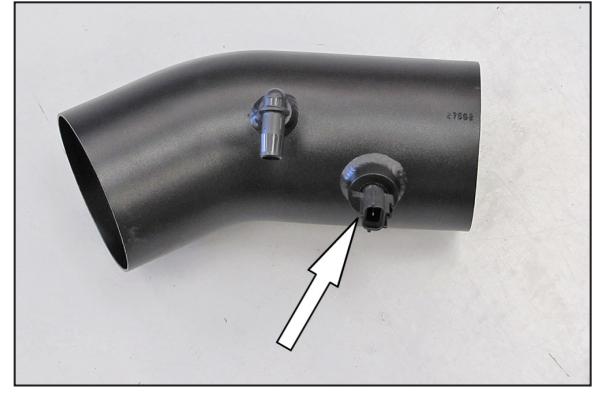

17. Install the inlet air temperature sensor into the K&N® intake tube as shown.

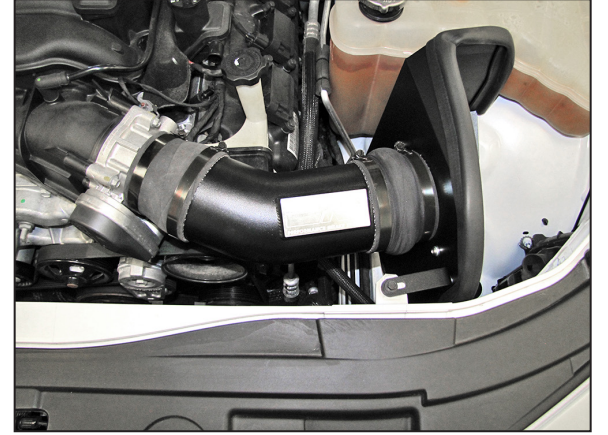

18. Install the K&N® intake tube into the silicone hump hose and then into the silicone step hose at the throttle body. Align the intake tube and heat shield for proper fit and then secure the intake tube with the provided hose clamps and the heat shield bracket with the factory air box retaining bolt removed in an earlier step.

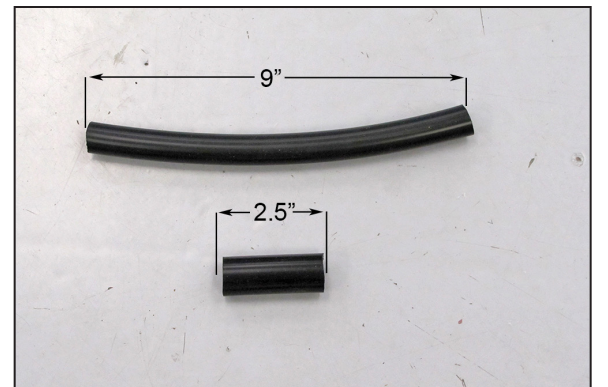

19. Cut the provided 1/2" silicone vent hose to a length of 9" long, and cut the 5/8" vent line to a length of 2.5" long.



20. Assemble the two vent lines together using the provided hose mender.

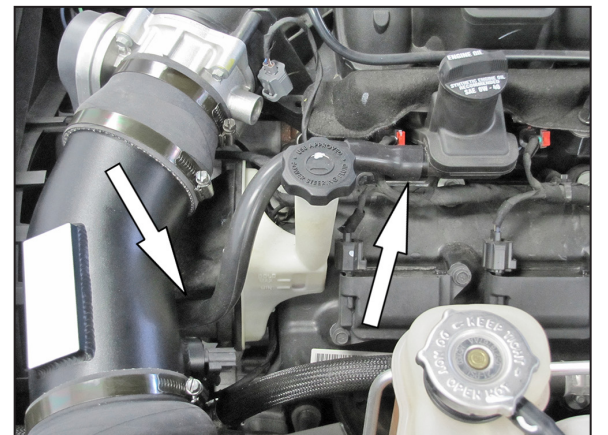

21. Install the assembled vent hose onto the fitting installed in the K&N® intake tube and then attach the open end to the valve cover port.

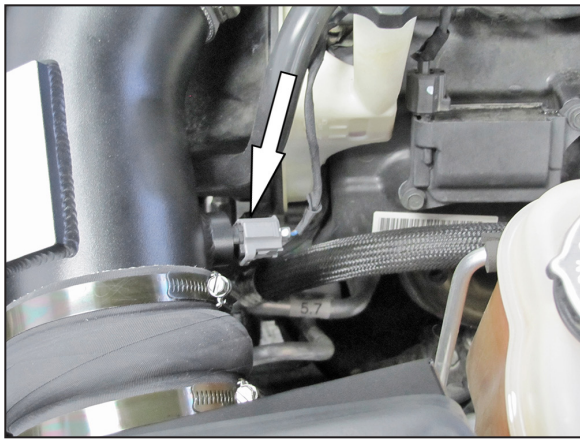

22. Reconnect the inlet air temperature sensor electrical connection.



23. Reinstall the coil cover.



24. Install the K&N® air filter and secure with the provided hose clamp.



25. Reconnect the vehicle's negative battery cable. Double check to make sure everything is tight and properly positioned before starting the vehicle.

26. It will be necessary for all K&N® high flow intake systems to be checked periodically for realignment, clearance and tightening of all connections. Failure to follow the above instructions or proper maintenance may void warranty.

#### ROAD TESTING:

1. Start the engine with the transmission in neutral or park, and the parking brake engaged. Listen for air leaks or odd noises. For air leaks secure hoses and connections. For odd noises, find cause and repair before proceeding. This kit will function identically to the factory system except for being louder and much more responsive.

2. Test drive the vehicle. Listen for odd noises or rattles and fix as necessary.

3. If road test is fine, you can now enjoy the added power and performance from your kit.

4. K&N Engineering, Inc., requires cleaning the Blackhawk Induction™ intake system's air filter element every 100,000 miles. When used in dusty or off-road environments, our filters will require cleaning more often. We recommend that you visually inspect your filter once every 25,000 miles to determine if the screen is still visible. When the screen is no longer visible some place on the filter element, it is time to clean it. To clean, purchase our Synthetic Filter Cleaner, part number 99-0624 and follow the easy instructions.