



AIRCHARGER™

HIGH-FLOW INTAKE KITS

INSTALLATION INSTRUCTIONS

63-9036

TOYOTA

2012-15 Tundra

V8-5.7L

NOTE: This kit was not designed to fit vehicles with a body lift.

TOOLS NEEDED:

- 9/16 Wrench
- 3mm Allen Wrench
- 4mm Allen Wrench
- 10mm Socket
- 10mm Wrench
- Extension
- Flat Blade Screwdriver
- Phillips Screwdriver
- Ratchet

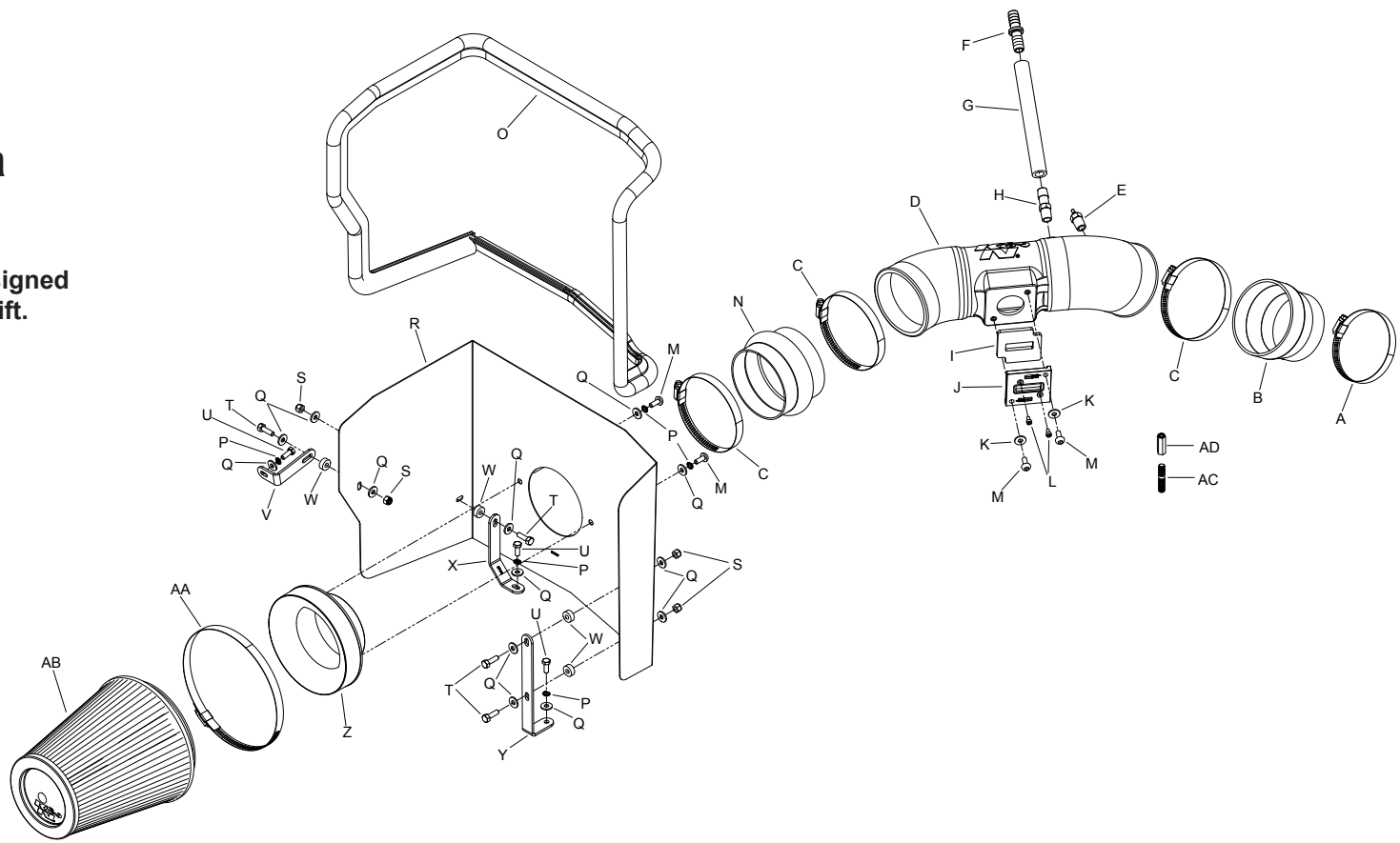

PARTS LIST:

Description	Qty.	Part #
A Hose Clamp # 56	1	08620
B Hose; 4" ID To 3.5" ID X 3" L TPRD	1	08497
C Hose Clamp # 64 Stainless	3	08645
D Intake Tube (IQ)	1	087258
E Vent; STRT, 1/8 Hose, 1/4 NPT, Plastic	1	08052
F Hose Mender; 1/2" Barbed, Nylon	1	08686
G Hose; 1/2" ID X 7"L	1	08159
H Vent; STRT 1/2" Hose, 1/4"NPT, Plas	1	080022
I Gasket; 57-2556, 3/16 PORON	1	09069
J Adaptor; #420, Nylon 6/6 GF, Black	1	21515
K Washer; 6MM Flat, SS	2	08269
L Bolt; M4-0.07 8MM, A/H Cap, SS	2	07733
M Bolt; M6 X 1.00 X 16MM, Buttonhead, SS	4	07730
N Hose; 4" ID X 3" L Hump Reinforced	1	08418
O Edge Trim (75")	1	102460
P Washer; M6 Split Lock Zinc	5	1-3025
Q Washer; 1/4" ID X 5/8" OD -SAE	13	08275
R Heat Shield	1	074107
S Nut; 6MM Nylock, Hexhead, SS	4	07512
T Bolt; M6 X 1.00" X 20MM Hex, SS	4	07795
U Bolt; 6MM-1.00 X 16MM, SS	3	07812
V Bracket; 57-3017, "L," Fin, TB/PC	1	070742
W Spacer; .625" OD X .250" ID X .250" L	4	06555
X Bracket; 63-1088, Mild STL, TB/PC	1	07190
Y Bracket; 57-1513, L-Bend, Fin, TB/PC	1	070902
Z Adaptor; 57-3058 #454	1	27300
AA Hose Clamp # 104	1	08697
AB Air Filter	1	RF-1044
AC Stud	1	1-107
AD Nut	1	08254

NOTE: FAILURE TO FOLLOW INSTALLATION INSTRUCTIONS AND NOT USING THE PROVIDED HARDWARE MAY DAMAGE THE INTAKE TUBE, THROTTLE BODY AND ENGINE.

TO START:

1. Turn off the ignition and disconnect the negative battery cable.

NOTE: Disconnecting the negative battery cable erases pre-programmed electronic memories. Write down all memory settings before disconnecting the negative battery cable. Some radios will require an anti-theft code to be entered after the battery is reconnected. The anti-theft code is typically supplied with your owner's manual. In the event your vehicles' anti-theft code cannot be recovered, contact an authorized dealership to obtain your vehicles anti-theft code.

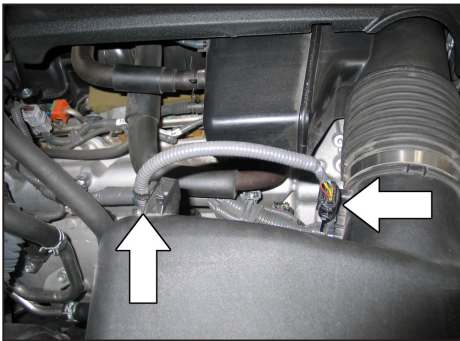

2. Disconnect the mass air sensor electrical connection and unhook the wiring harness from the air box.



3. Lift off the engine cover.



4. Loosen the hose clamp that secures the intake tube to the throttle body.

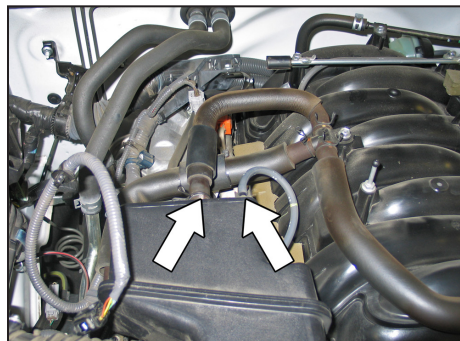

5. Disconnect the crank case vent hose and fuel pressure line from the intake resonator.



6. Release the four retaining clips securing the upper air box and then remove the upper air box and intake tube assembly from the vehicle.



7. Loosen the two bolts securing the lower air box and then remove the lower air box from the vehicle. **NOTE: K&N Engineering, Inc., recommends that customers do not discard factory air intake.**

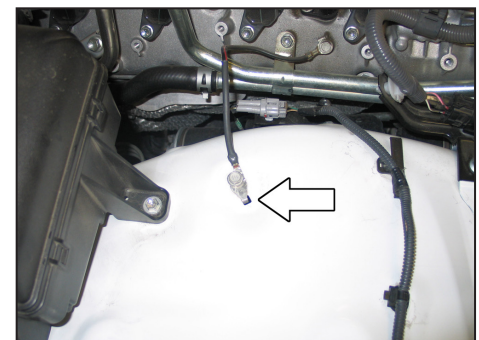

8. Remove the bolt that secures the ground strap to the inner fender.

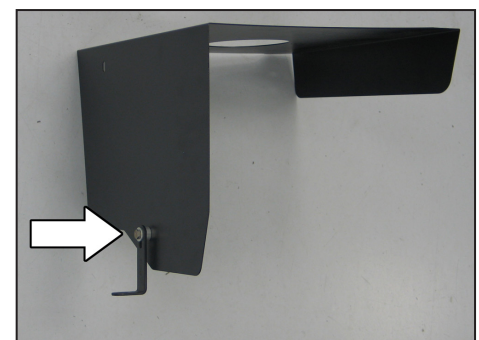

9. Install the heat shield mounting bracket (070742) onto the heat shield using the provided spacer and hardware.

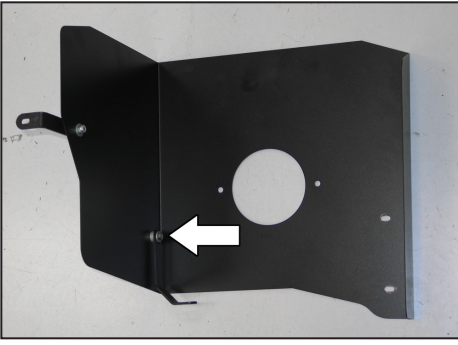

10. Install the heat shield mounting bracket (07190) onto the heat shield using the provided spacer and hardware.

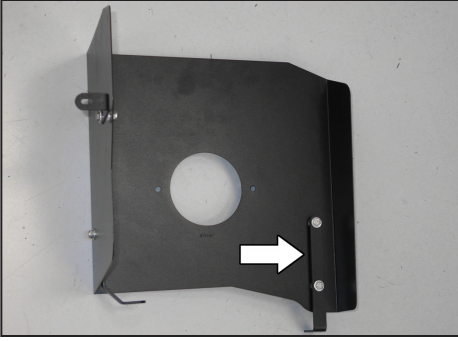

11. Install the heat shield mounting bracket (070902) onto the heat shield using the provided spacers and hardware.

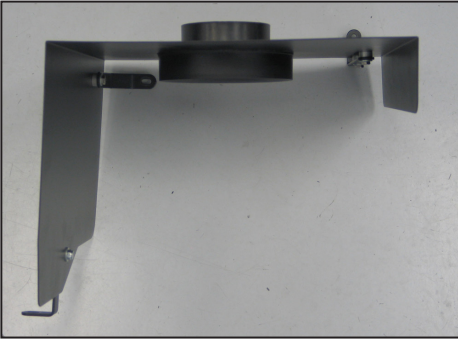

12. Install the filter adapter into the heat shield and secure with the provided hardware.



13. Install the provided edge trim onto the heat shield as shown.
NOTE: Some trimming of the edge trim will be necessary.



14. Set the heat shield into the engine compartment and secure the factory nuts and with the provided hardware.

NOTE: Be sure to place the ground strap between the mounting bracket and the inner fender and then secure with the heat shield mounting bolt.



15. Install the silicone hose (08497) onto the throttle body and secure with the provided hose clamp.

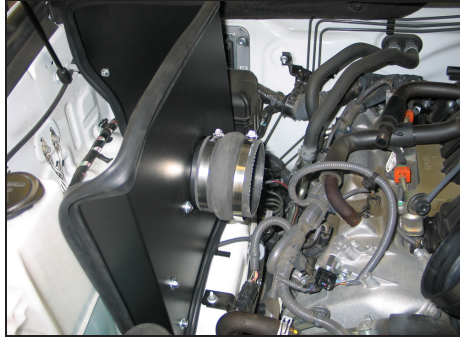

16. Install the silicone hump hose (08418) onto the filter adapter and secure with the provided hose clamp.



17. Remove the two screws securing the mass air sensor and then remove the mass air sensor from the upper air box housing.



18. Install the gasket onto the provided mass air adapter as shown.

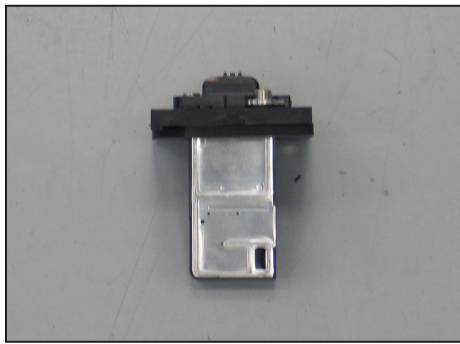

19. Install the mass air sensor through the K&N® mass air sensor adapter as shown. Secure using the provided hardware.

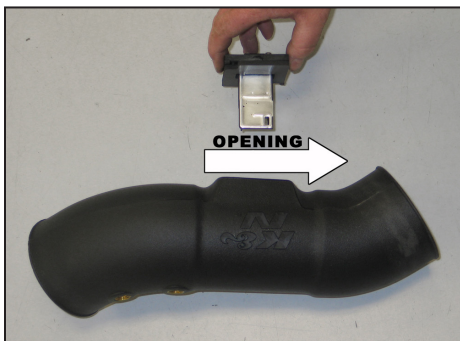

20. Install the mass air sensor assembly into the K&N® intake tube so that the opening in the sensor faces the filter end of the tube as shown.



21. Install the provided NPT vent fittings into the K&N® intake tube as shown.

NOTE: Plastic NPT fittings are easy to cross thread. Install the vent fitting "hand" tight, then turn it two complete turns with a wrench.



22. Install the hose mender into the provided crank case vent hose as shown.

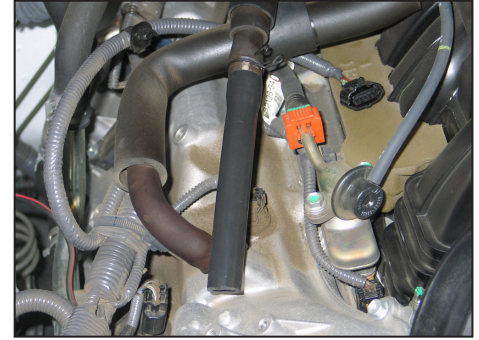

23. Install the crank case vent hose assembly into the factory crank case vent hose as shown.

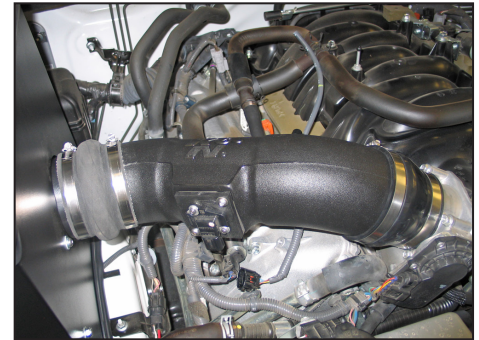

24. Insert the K&N® intake tube into the hump hose attached to the heat shield and then into the step hose attached to the throttle body. Secure with the provided hose clamps.



25. Connect the crank case vent hose and the fuel pressure hose to the fittings connected to the K&N® intake tube.

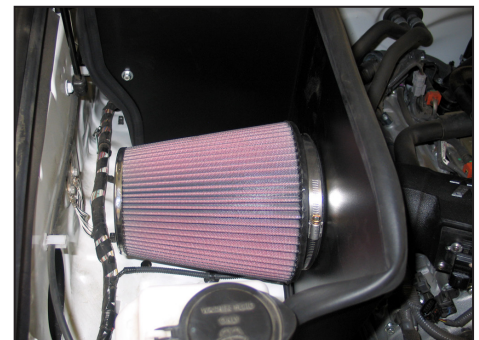

26. Install the K&N® air filter and secure with the provided hose clamp.
NOTE: Drycharger® air filter wrap; part # RF-1020DK is available to purchase separately.



27. Reconnect the mass air sensor electrical connection.

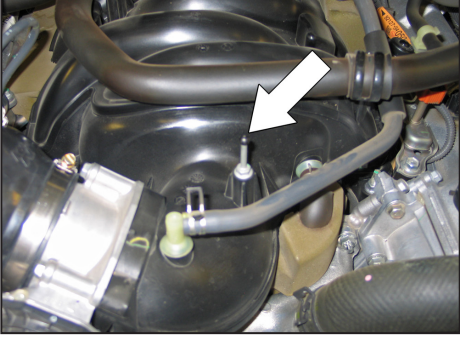

28. Remove the front engine cover mounting stud from the intake manifold.

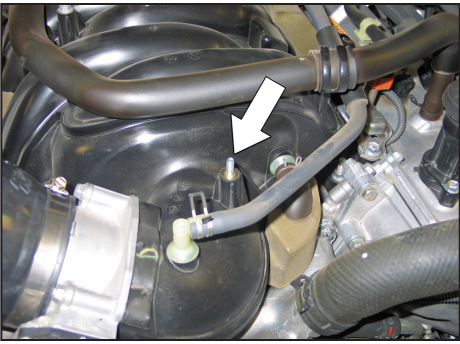

29. Install the provided stud into the mounting stud location as shown.

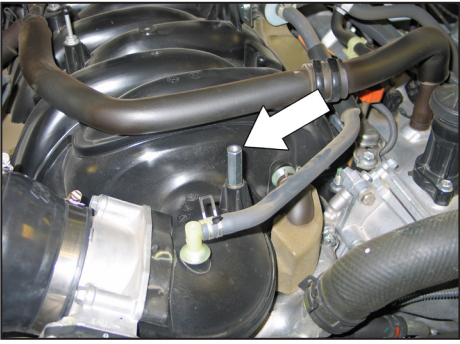

30. Install the provided nut extension onto the stud as shown.

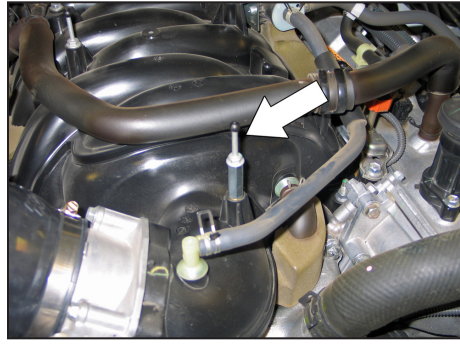

31. Install the factory mounting stud into the nut extension as shown.



32. Install the engine cover.



33. Reconnect the vehicle's negative battery cable. Double check to make sure everything is tight and properly positioned before starting the vehicle.

34. It will be necessary for all K&N® high flow intake systems to be checked periodically for realignment, clearance and tightening of all connections. Failure to follow the above instructions or proper maintenance may void warranty.

ROAD TESTING:

1. Start the engine with the transmission in neutral or park, and the parking brake engaged. Listen for air leaks or odd noises. For air leaks secure hoses and connections. For odd noises, find cause and repair before proceeding. This kit will function identically to the factory system except for being louder and much more responsive.

2. Test drive the vehicle. Listen for odd noises or rattles and fix as necessary.

3. If road test is fine, you can now enjoy the added power and performance from your kit.

4. K&N Engineering, Inc., requires cleaning the intake system's air filter element every 100,000 miles. When used in dusty or off-road environments, our filters will require cleaning more often. We recommend that you visually inspect your filter once every 25,000 miles to determine if the screen is still visible. When the screen is no longer visible some place on the filter element, it is time to clean it. To clean and re-oil, purchase our filter Recharger® service kit, part number 99-5050 or 99-5000 and follow the easy instructions.