



AIRCHARGER[®]

HIGH-FLOW INTAKE KITS

INSTALLATION INSTRUCTIONS

63-9035

TOYOTA

2010-15 Tundra

V8-4.6L

NOTE: This kit was not designed to fit vehicles with a body lift.

TOOLS NEEDED:

- Ratchet
- Extension
- 10mm Socket
- 13mm Socket
- Flat Blade Screwdriver
- Phillips Screwdriver
- Pliers
- 10mm Wrench
- 5/8" Wrench
- 9/16" Wrench
- 3mm Allen Wrench
- 4mm Allen Wrench

PARTS LIST:

Description	EE	Qty.	Part #								
A	Hose Clamp #56	2	08620	L	Bolt; M6 X 1.00 X 16mm, BtnHd. SS	2	07730	W	Bolt; M6 X 1.00" X 20mm Hex, SS	4	07795
B	Hose; 3-1/2" ID X 2"L Molded	1	08630	M	Bolt; 6mm-1.00 X 16mm, SS	3	07812	X	Bracket; Mild STL, TB/PC	1	07190
C	Hose; 1/2" ID X 17" L	1	08177	N	Washer; 1/4" ID X 5/8" OD- SAE	15	08275	Y	Bracket; "L", Fin. TB/PC	1	070742
D	Vent; STRT 1/2" Hose, 1/4" NPT, Plas.	1	080022	O	Bracket; "L", STL, TB/PC	1	083152	Z	Hose Clamp #64 Stainless	2	08645
E	Intake Tube	1	087248	P	Stud; Rubber MNT, M/F, 1/2"L X 1"W, M6	2	070228	AA	Hose; 4" ID X 2"L Molded	1	08625
F	Vent; STRT, 3/16 Barbed 1/4"NPT, Nylon	1	080021	Q	Nut; 6mm Nylock, Hexhead, SS	6	07512	BB	Edge Trim; 3/4" Bulb, Top Loc, 20"L	1	102494
G	Gasket; 3/16 Poron	1	09069	R	Edge Trim (75")	1	102460	CC	Adaptor; #454	1	27300
H	Adaptor; Nylon 6/6 GF, Blk.	1	21515	S	Heat Shield	1	07653-1	DD	Hose Clamp #104	1	08697
I	Washer; 6mm Flat, SS	2	08269	T	Spacer (Alum)	4	06555	EE	Air Filter	1	RF-1042XD
J	Washer; 1/4" Lock ZN	7	08198	U	Bracket; L-Bend, Fin. TB/PC	1	070902				
K	Bolt; M4-0.07 8mm, A/H Cap, SS	2	07733	V	Bolt; M6 X 1.00 X 12mm, Hexhead, SS	2	07727				

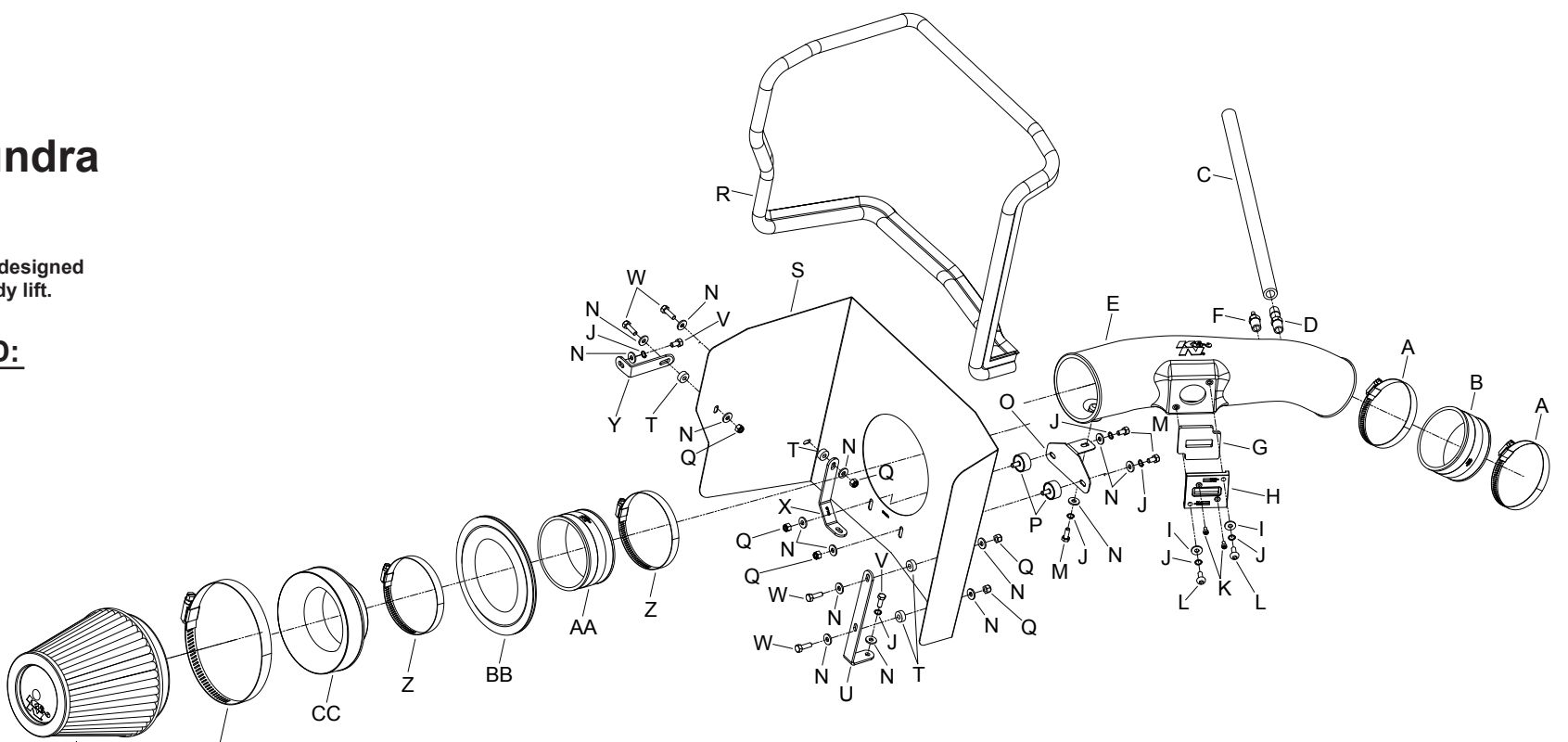

NOTE: FAILURE TO FOLLOW INSTALLATION INSTRUCTIONS AND NOT USING THE PROVIDED HARDWARE MAY DAMAGE THE INTAKE TUBE, THROTTLE BODY AND ENGINE.

TO START:

1. Turn off the ignition and disconnect the negative battery cable.
NOTE: Disconnecting the negative battery cable erases pre-programmed electronic memories. Write down all memory settings before disconnecting the negative battery cable. Some radios will require an anti-theft code to be entered after the battery is reconnected. The anti-theft code is typically supplied with your owner's manual. In the event your vehicles' anti-theft code cannot be recovered, contact an authorized dealership to obtain your vehicles anti-theft code.



2. Lift up the engine cover to dislodge it from the mounting studs and then remove the engine cover from the vehicle.

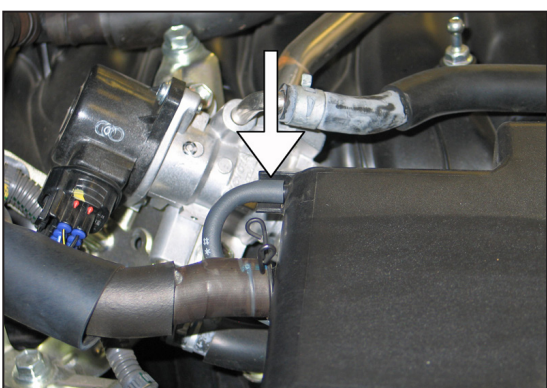

3. Disconnect the fuel pressure regulator vacuum hose from the intake tube.

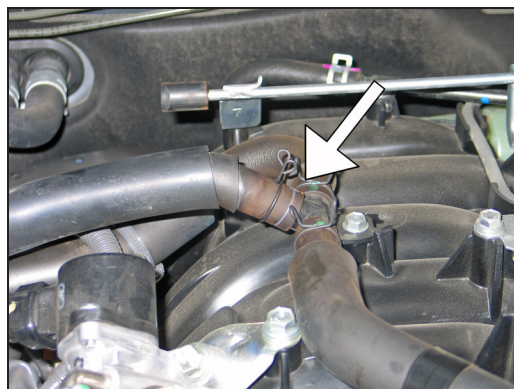

4. Disconnect the crankcase vent hose from the Tee fitting on top of the intake manifold plenum.



5. Disconnect the mass air sensor electrical connection and unhook the wiring harness from the upper airbox.



6. Loosen the hose clamp that secures the factory intake tube to the throttle body.

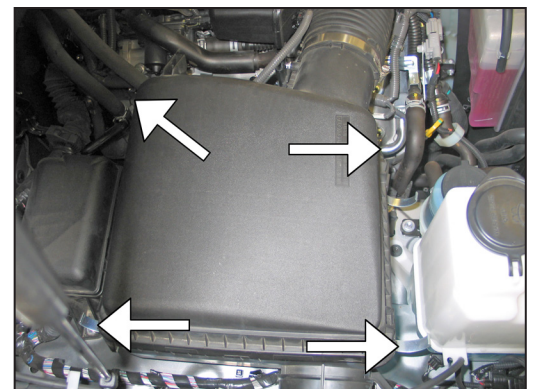

7. Release the four latches securing the upper airbox to the lower airbox.



8. Remove the upper airbox/intake hose assembly from the vehicle.

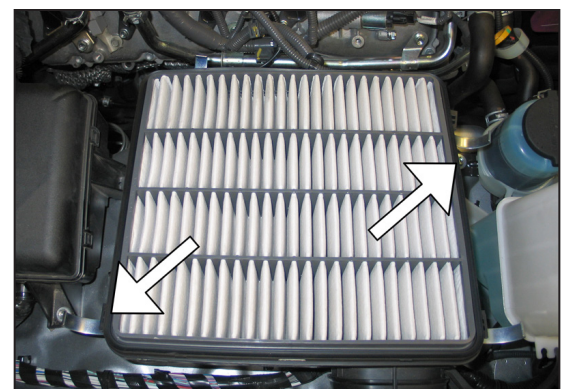

9. Loosen the two bolts securing the lower airbox into the vehicle.

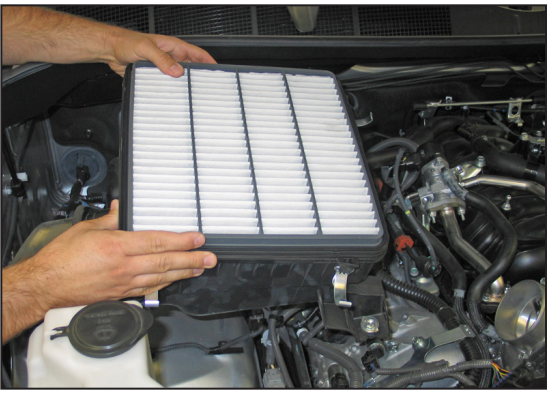

10. Remove the lower airbox from the vehicle.
NOTE: K&N Engineering, Inc., recommends that customers do not discard factory air intake.

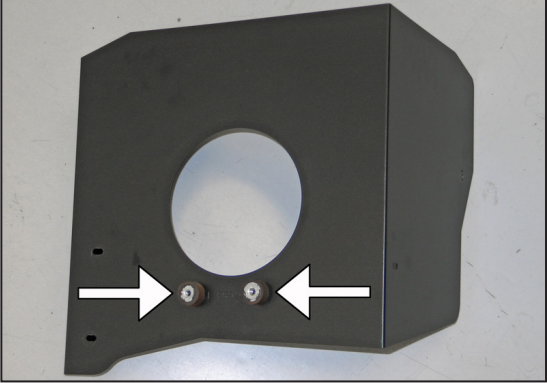

11. Install the two rubber mounted studs onto the heat shield as shown using the provided hardware.

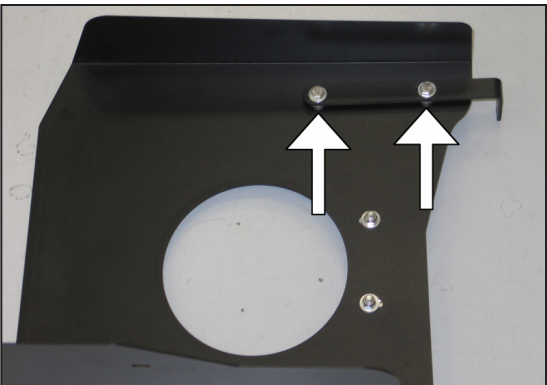

12. Install the heat shield mounting bracket (070902) onto the heat shield as shown using the provided spacers and hardware.

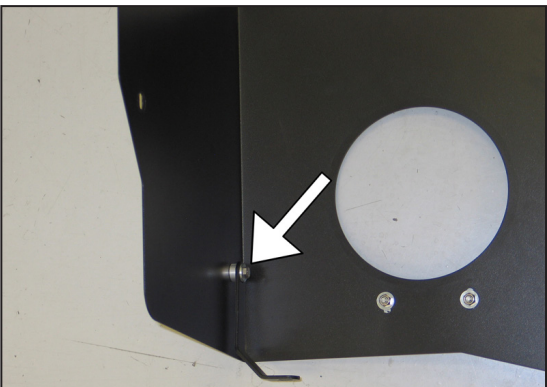

13. Install the provided heat shield mounting bracket (07190) onto the heat shield using the provided hardware and spacer as shown.

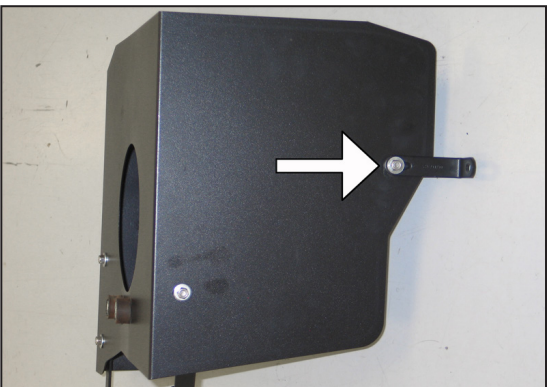

14. Install the provided heat shield mounting bracket (070742) onto the heat shield using the provided hardware and spacer as shown.

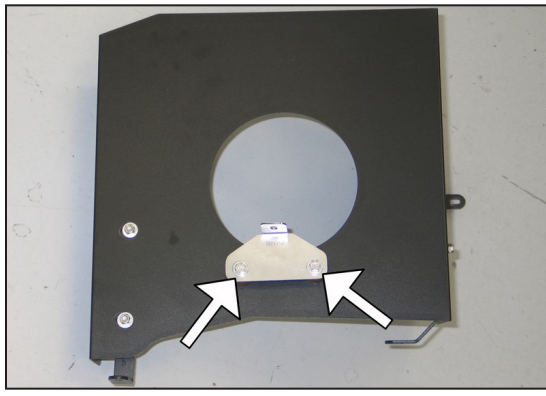

15. Install the tube mounting bracket (083152) onto the rubber mounted studs as shown using the provided hardware.

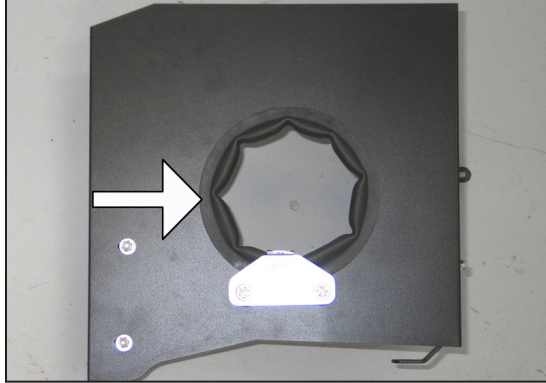

16. Install the provided shorter edge trim into the hole of the heat shield as shown.
NOTE: Trimming of the edge trim will be necessary.

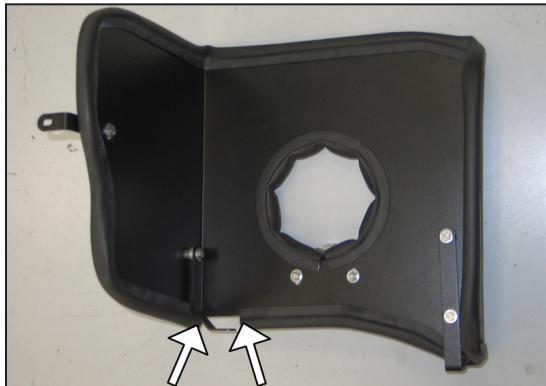

17. Install the provided longer edge trim onto the heat shield as shown.
NOTE: Trimming of the edge trim will be necessary.

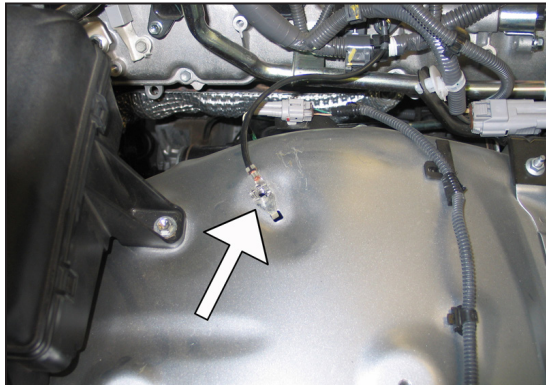

18. Remove the bolt that secures the ground strap to the inner fender.
NOTE: This bolt will be reused.

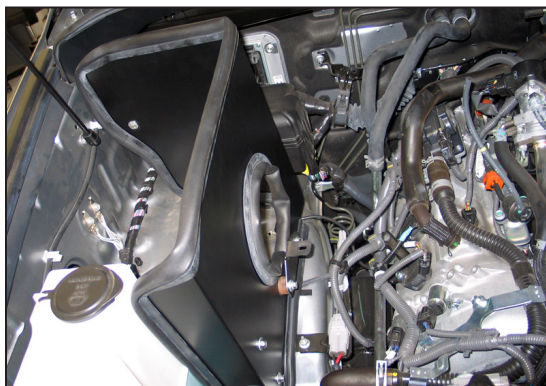

19. Set the heat shield into position on the inner fender and then secure with the factory bolt removed in step #18 with the provided hardware.
NOTE: Ensure the ground strap is between the mounting bracket and inner fender.

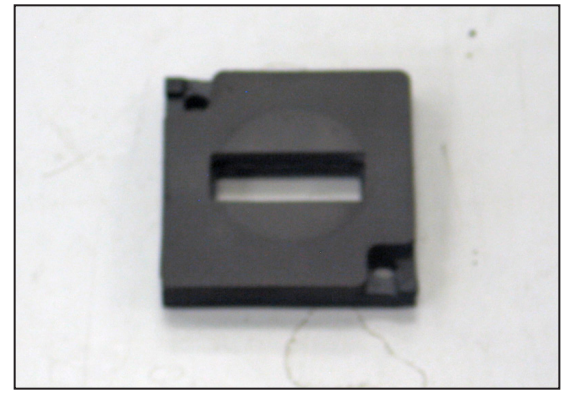

20. Install the provided gasket onto the bottom of the K&N® mass air sensor adapter as shown.

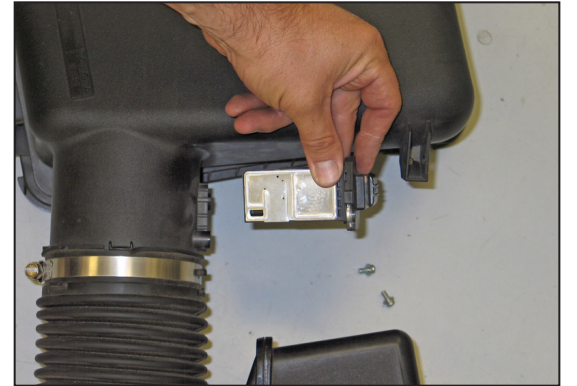

21. Remove the mass air sensor from the factory airbox.

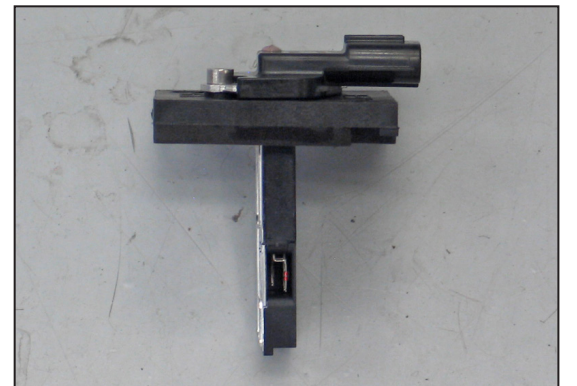

22. Install the mass air sensor into the K&N® mass air sensor adapter and secure with the provided hardware.

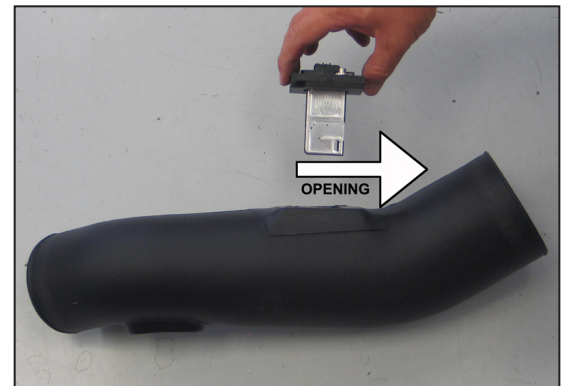

23. Install the mass air sensor assembly into the K&N® intake tube as shown using the provided hardware.
NOTE: Ensure the opening is pointed towards the filter end of the intake tube.



24. Install the provided NPT vent fittings into the K&N® intake tube as shown.
NOTE: Plastic NPT fittings are easy to cross thread. Install the vent fitting "hand" tight, then turn it two complete turns with a wrench.



25. Install the provided silicone (08630) hose onto throttle body and secure with the provided hose clamp.

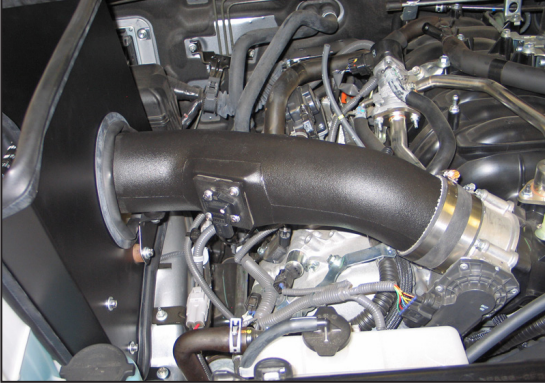

26. Install the K&N® intake tube assembly into the silicone hose at the throttle body and align with the tube mounting bracket on the heat shield. Secure the tube with the provided hardware and hose clamp.

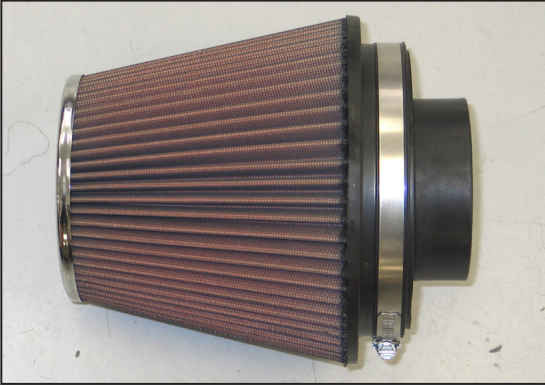

27. Install the filter adapter into the K&N® air filter and secure with the provided hose clamp.



28. Install the provided silicone hose onto the filter adapter and secure with the provided hose clamp.

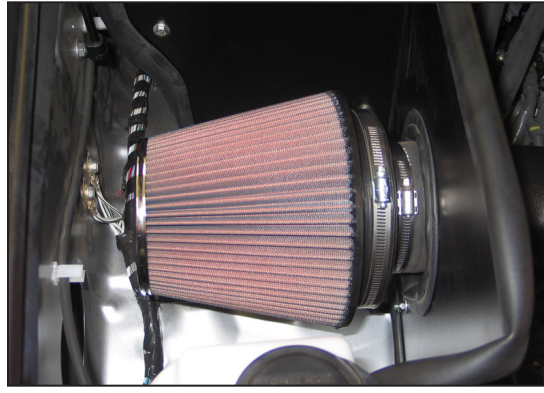

29. Install the filter assembly onto the K&N® intake tube and secure with the provided hose clamp. **NOTE: Drycharger® air filter wrap; part # RF-1042DK is available to purchase separately.**

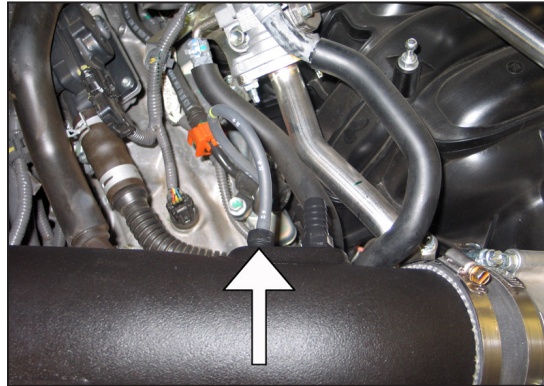

30. Connect the fuel pressure regulator vent line to the NPT fitting installed into the K&N® intake tube.

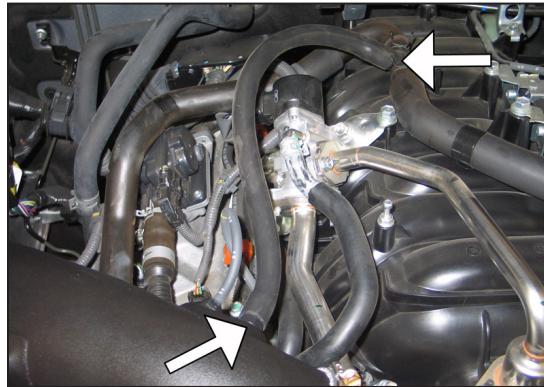

31. Install the provided crankcase vent line onto the NPT fitting installed into the K&N® intake tube and connect the open end onto the factory Tee.

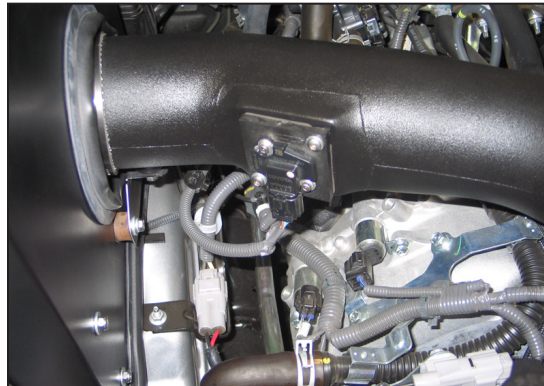

32. Reconnect the mass air sensor electrical connection.



33. Reinstall the engine cover.



34. Reconnect the vehicle's negative battery cable. Double check to make sure everything is tight and properly positioned before starting the vehicle.

35. It will be necessary for all K&N® high flow intake systems to be checked periodically for realignment, clearance and tightening of all connections. Failure to follow the above instructions or proper maintenance may void warranty.

ROAD TESTING:

1. Start the engine with the transmission in neutral or park, and the parking brake engaged. Listen for air leaks or odd noises. For air leaks secure hoses and connections. For odd noises, find cause and repair before proceeding. This kit will function identically to the factory system except for being louder and much more responsive.

2. Test drive the vehicle. Listen for odd noises or rattles and fix as necessary.

3. If road test is fine, you can now enjoy the added power and performance from your kit.

4. K&N Engineering, Inc., requires cleaning the intake system's air filter element every 100,000 miles. When used in dusty or off-road environments, our filters will require cleaning more often. We recommend that you visually inspect your filter once every 25,000 miles to determine if the screen is still visible. When the screen is no longer visible some place on the filter element, it is time to clean it. To clean and re-oil, purchase our filter Recharger® service kit, part number 99-5050 or 99-5000 and follow the easy instructions.